

HOTEL EMPORIUM

# MAGNET SQUEEZE DISPENSER INSTALLATION GUIDE

NON-REFILLABLE / 450ML e 15.2 FL OZ

DISPENSER SIZE: 65 L x 78 W x 249 H (mm)

MATERIAL: PE Bottle & ABS Bracket

INFO: Tamper-Resistant Bracket, Patented Valve Cap, & Fluid Indicator Window



# MAGNET SQUEEZE DISPENSER INSTALLATION GUIDE

## PARTS INCLUDED IN INSTALLATION KIT

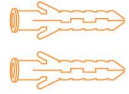

(3)  
WALL ANCHORS

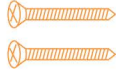

(3)  
SCREWS



(3)  
SCREW COVERS



(1)  
3M TAPE



(1)  
BRACKET



(1)  
BOTTLE



(1)  
MAGNETIC KEY

## RECOMMENDED PLACEMENT GUIDE

ON THE BACK WALL, OPPOSITE OF THE SHOWER HEAD  
(NOT TO SCALE)

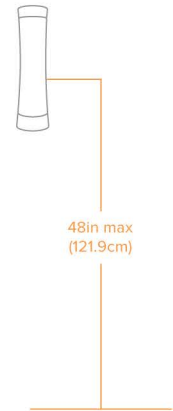
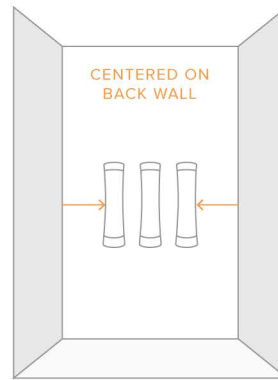
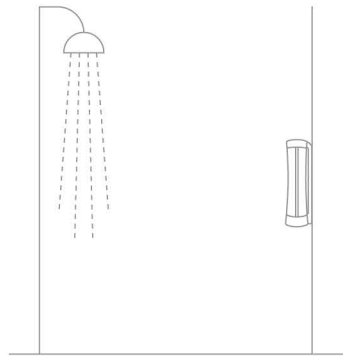
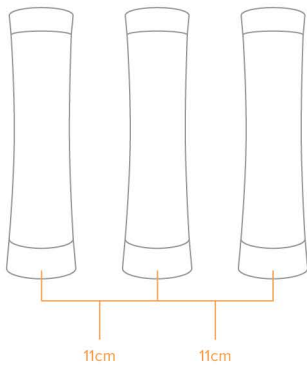

ADA COMPLIANT  
(Operable part must be located within the reach ranges)

## RECOMMENDED TOOLS



ALCOHOL WIPE



PENCIL



LEVEL



TAPE MEASURE



TAPE



CAULK

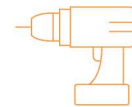

POWER DRILL



HAMMER



SCREW DRIVER

## ADDITIONAL INFO

Do not use a corrosive detergent.  
Use a soft damp cloth, warm water, and mild cleaner to clean bottles and brackets.  
Recommended installation is mounting bracket with both screws and tape.

## MAGNET KEY INFO



**Avoid magnetic key contact from all electronic devices and IC cards.**  
Ask staff to hang magnetic key on the handlebars of the cleaning trolley.

# MAGNET SQUEEZE DISPENSER INSTALLATION GUIDE

1

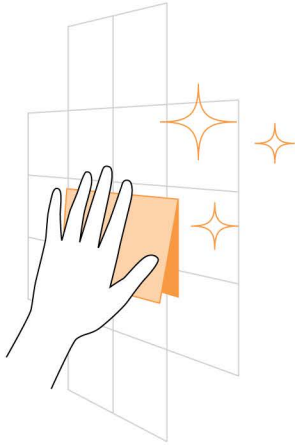

Clean surface thoroughly with alcohol wipe. Make sure surface is fully dry before installation.

2

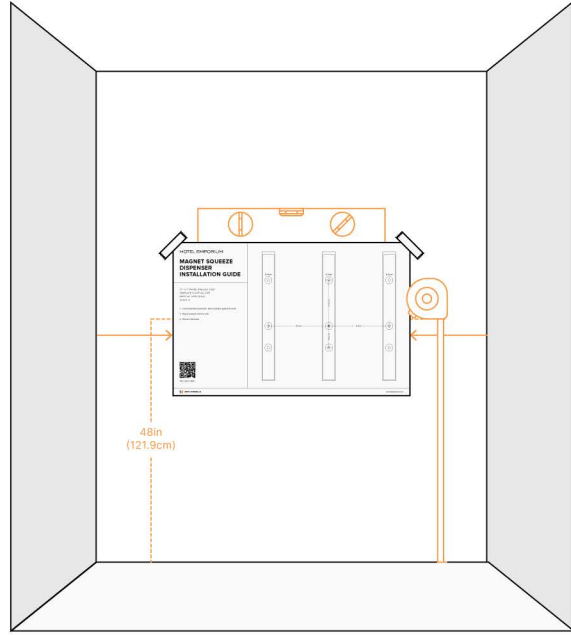

Determine the proper placement of dispenser. Tape template onto the wall and make sure template is level. Recommended height is 48" from the floor to the middle of the dispensers.

3A

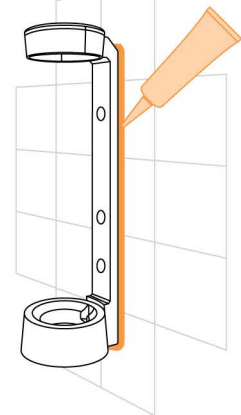
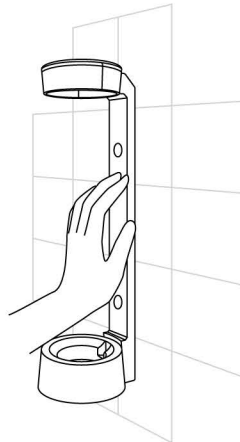
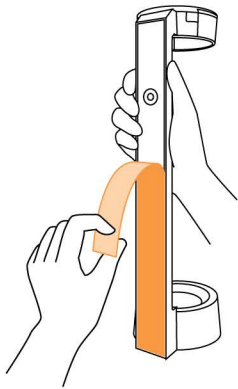

## Tape Installation

1. For tape installation, clean back of bracket then adhere the double sided 3M mounting tape to the bracket. Peel film off.
2. Press bracket firmly onto the wall for 30 seconds until it is secured. Repeat process for other brackets. Remove template.
3. Add screw covers into holes on the bracket.
4. Place a line of adhesive caulk around the bracket to prevent water and grime from getting behind the bracket. Wipe away any excess caulk. Wait 72 hours before inserting the bottles to allow tape to securely set.

3B

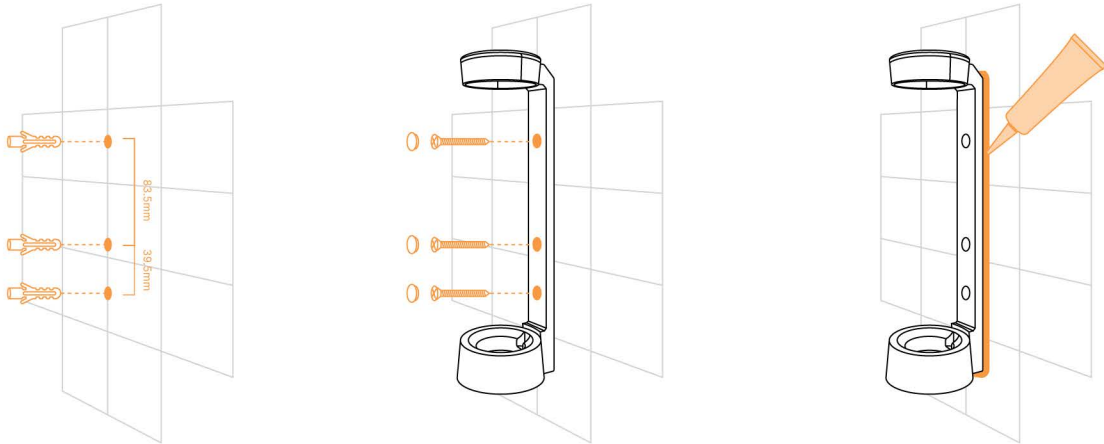

**Screw Installation**

1. For screw installation, use bracket to mark the bracket holes on the wall. Drill bracket holes into the wall.
2. Insert wall anchors with your hands, then use a hammer to tap anchors flush into the wall.
3. Place bracket into position on the wall and tighten screws in place. Add screw covers over the screws.
4. **Place a line of adhesive caulk** around the bracket to prevent water and grime from getting behind the bracket. Wipe away any excess caulk. **Wait 24 hours** for caulk to dry.

4

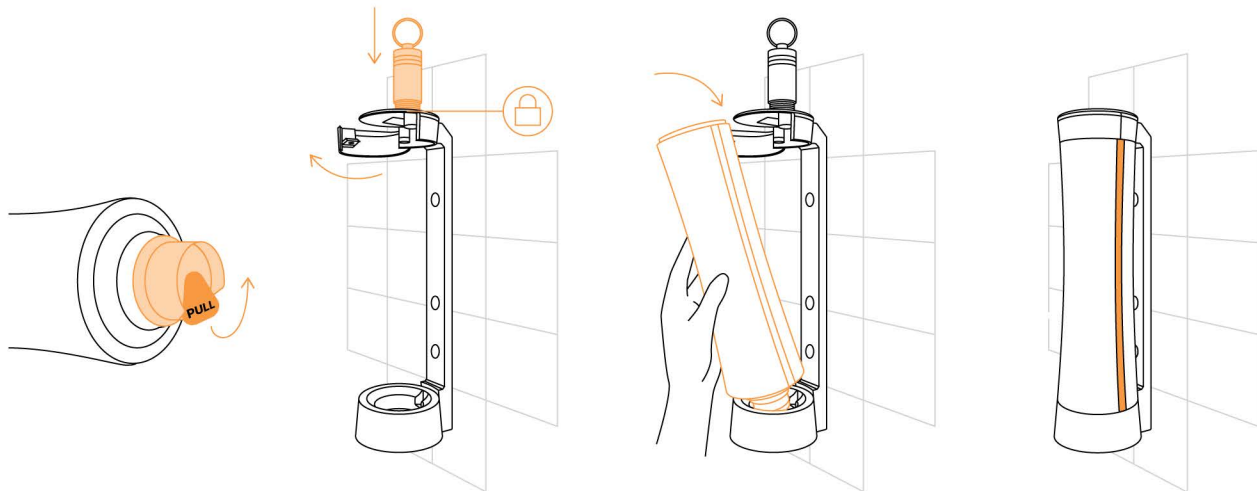

**Preparing & Replacing Bottles**

Pull the valve cap tab at the bottom of the bottle to prepare bottle for use. Unscrew magnetic key cap and place key on the lock symbol to unlock the bracket. Open bracket arm and place the bottle inside. Close the arm and remove key. **Dispenser is ready to use!**

To replace bottles, repeat steps above.

# MAGNET SQUEEZE DISPENSER INSTALLATION GUIDE

17" x 11" PAPER (TABLOID SIZE)  
TEMPLATE IS ACTUAL SIZE  
PRINT AT 100% SCALE  
SCALE 1:1

1. Level template placement. Tape template against the wall.
2. Mount bracket onto the wall.
3. Remove template.



SEE VIDEO DEMO

