

H A L F | H U M A N

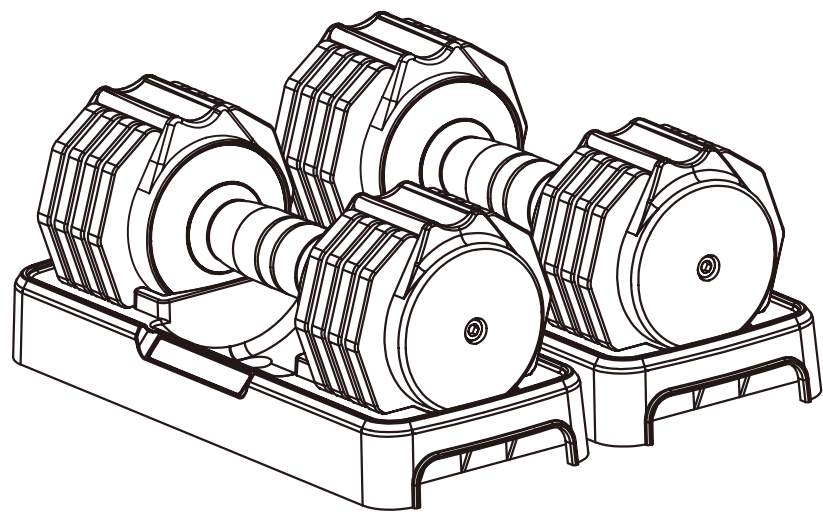

ADJUSTABLE DUMBBELL PAIR
25 KG (55 LBS)

OWNER'S MANUAL

Please carefully read this entire manual before operating your new adjustable dumbbell.

PRODUCT COMPONENTS

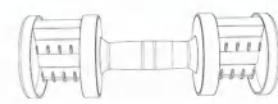

Handle

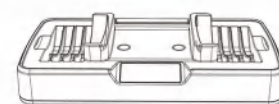

Dumbbell tray *1



Counterweight

DUMBBELL INFORMATION

1. Note: there're 5 weights increments from 5KG to 25KG.

2. Secondly, Choose the right weight by rotating the middle of handle grip. The arrow will show you the direction of the weight from lower to higher.



3. Finally, take it out from the dumbbell base, and you can start exercises. Don't worry about the weight plates, as the structure keeps the weight plates symmetrically.

1

IMPORTANT SAFETY INSTRUCTIONS

Read **ALL** instructions before using this appliance. **WARNING!** To reduce the risk of injury to persons:

1. This exercise equipment is not intended for use by persons with reduced physical, sensory or mental capabilities, or lack of experience and knowledge.
2. Use this appliance only for its intended use as described in this manual. Do not use attachments not recommended by the manufacturer.
3. Never drop or insert any object into any opening.
4. The equipment is intended for household use.
5. Before beginning this or any exercise program, consult a physician. This is especially important for persons over the age of 35 or persons with pre-existing health conditions.
6. Keep hands away from all moving parts.
7. Do not attempt to use your equipment for any purpose other than for the purpose it is intended.
8. Wear proper shoes. High heels, dress shoes, sandals or bare feet are not suitable for use on your equipment. Quality athletic shoes are recommended to avoid leg fatigue.
9. Please use the adjustable dumbbells instructions step by step to avoid unnecessary damage to the product.
10. In the event of nausea, shortness of breath, dizziness, headache, chest distress, or any discomfort, stop exercising immediately.
11. In order to achieve significant exercise results and not to overburden the muscles, the exercise frequency should be administered within a reasonable range. Consult a personal trainer to learn correct posture, technique, methods, and frequency.
12. Inspect the equipment thoroughly before each use. Do not use the product with damaged or work components or parts.
13. If the equipment is found to be worn, loose, or rusted, it should be repaired or replaced in a timely manner to ensure that all components are always in good working condition.
14. Please keep pets and children away from equipment. Do not allow children to play near this equipment or use it for any purpose. The minimum age of use for this equipment is 18 years old. Everyone under the age of 18 must be under parental supervision at all times.
15. Do not press the safety lock or turn the weight selector dial when the dumbbell or handle is lifted from the dumbbell tray.
16. Do not drop the dumbbells freely to the ground as it will cause damage to the product. In some cases, dropping the dumbbell freely may potentially cause a personal injury or death.
17. Do not bump the product against any other object as it will damage the product and may potentially cause a personal injury.
18. Do not take the product apart or disassemble any parts. Tampering with the product may potentially cause a personal injury.
19. This product is very heavy. For the highest level of safety place the dumbbell trays and dumbbells on the floor.
20. Use caution while participating in other activities while using your adjustable dumbbell such as watching television, reading, etc. These distractions may cause you to lose balance, resulting in serious injury.

Failure to follow all guidelines may compromise the effectiveness of the exercise experience, expose yourself (and possibly others) to injury, and reduce the longevity of the equipment.

SAVE THESE INSTRUCTIONS - THINK SAFETY!

Caution! Please be careful when unpacking the carton.

2

! TRAINING SAFETY WARNINGS

Consult a physician before starting an exercise program.
Stop exercising if you feel pain or tightness in your chest, become short of breath, or feel faint.
Contact your doctor before using the equipment again.
Choose your training intensity according to the training difficulty, training time, etc.
For more training moves, check out professional exercise manuals, books, and videos or consult a personal trainer to learn the correct posture, technique, and methods.

EXERCISE GUIDE

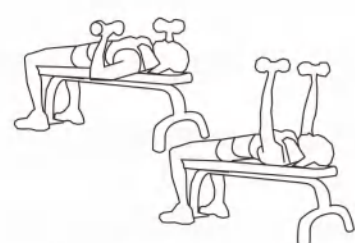

(1) Dumbbell Bench Press
2 sets * 10 reps

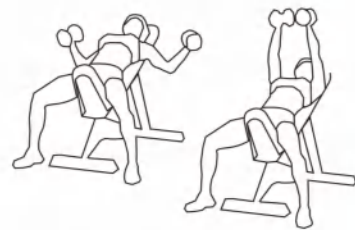

(2) Incline Dumbbell Fly
2 sets * 10 reps

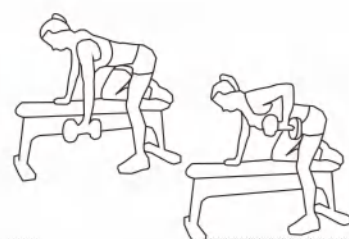

(3) One-arm Dumbbell Row
2 sets * 10 reps

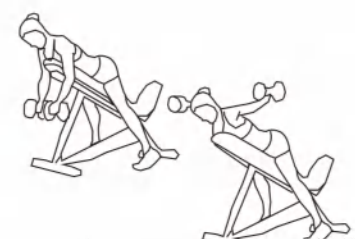

(4) Reverse Fly
2 sets * 10 reps

3

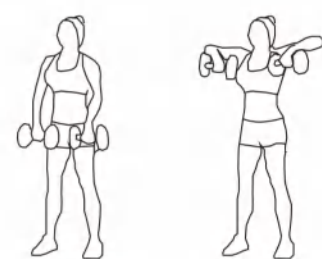

(5) Upright Dumbbell Row
2 sets * 10 reps

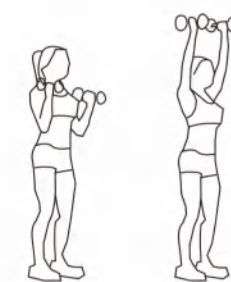

(6) Standing Dumbbell Press
2 sets * 10 reps

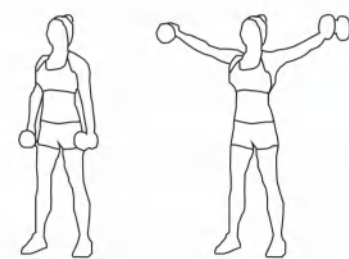

(7) Dumbbell Lateral Raise
2 sets * 10 reps

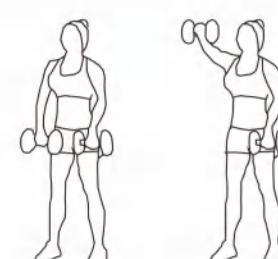

(8) Standing Dumbbell Front Raise
2 sets * 10 reps

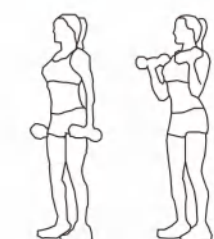

(9) Standing Dumbbell Curl
2 sets * 10 reps

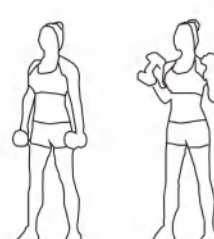

(10) Standing Top-down Dumbbell Curl
2 sets * 10 reps

4

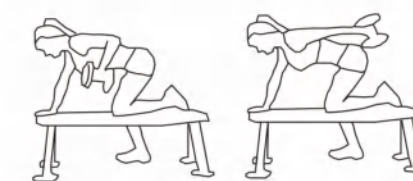

(11) Triceps Kickback
2 sets * 10 reps

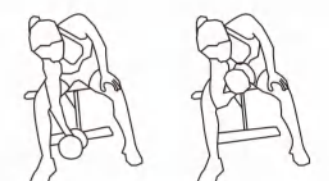

(12) Concentration Curl
2 sets * 10 reps

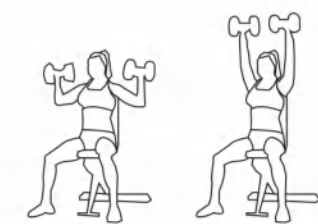

(13) Seated Dumbbell Press
2 sets * 10 reps

25 KG (55 LBS) ADJUSTABLE DUMBBELL TROUBLESHOOTING

PROBLEM : Adjustment handlebar doesn't turn around while handle is in base.

ANSWER : a. Ensure the handle is fully inserted into the dumbbell tray base. If not fully inserted, the locking mechanism will not be released.
b. Check to see if any weight plates were put into the wrong grooves or face backwards. All weight plates must have the selection tongue facing away from the handle grip.

5