



*Your Reliable Power Partner*



# ***Building Automation Solutions***

*Product Range Overview*



# Company Profile

Established in 1982, MEAN WELL is a leading standard switching power supply manufacturers in the world. MEAN WELL currently operates under five companies in Taiwan, China, USA and Europe and three factories in Taiwan, GuangZhou and SuZhou. The product lines include AC/DC switching power supplies, DC/DC converters, waterproof LED drivers, adaptors, DC/AC inverters and battery chargers. We have over 10,000 standard models widely used in medical, automation, communication, LED lighting, moving sign, and office automation applications.

With more than 30 years of experience in R&D and production of standard power supplies, MEAN WELL has ten product categories covering 10,000 models, to provide "One Stop Shopping" power solutions. Every product in MEAN WELL is the result of rigid procedures governing design, design verification test (DVT), design quality test (DQT), component selection, pilot-run production, and mass production.

With more than 200 distributors globally, the MEAN WELL products are distributed to over 80 countries worldwide. The small size orders can expect delivery within 24 hours without MOQ requirement. If you are looking for switching power supply with high reliability, good quality, reasonable price and full series products, MEAN WELL, a total solution provider which can satisfy your various demands, is definitely your first choice!



MEAN WELL USA



MEAN WELL EUROPE



MEAN WELL TAIWAN

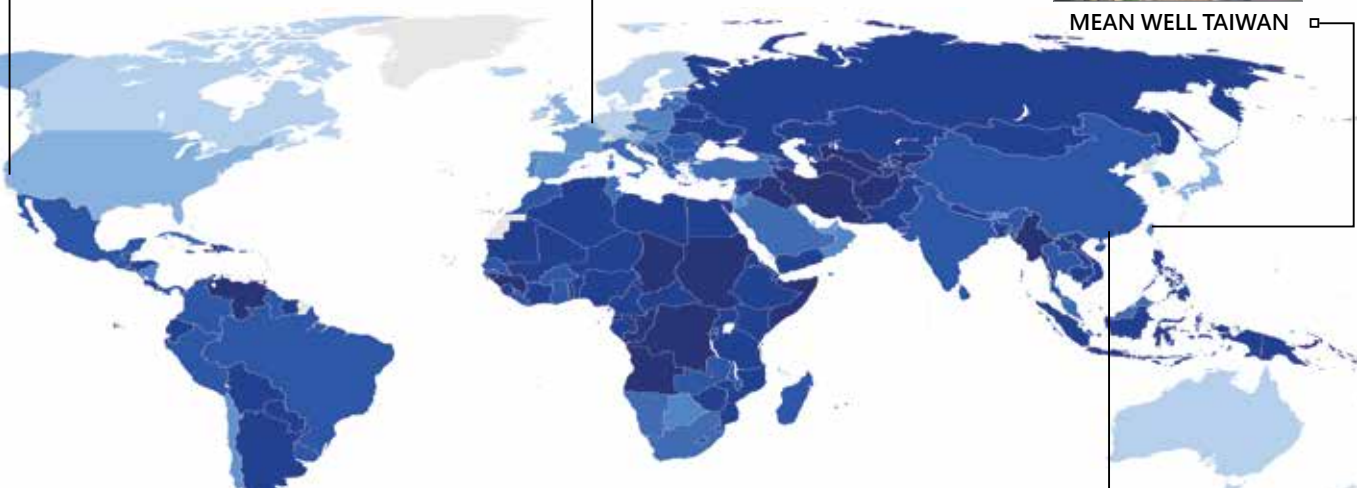

MEAN WELL SUZHOU



MEAN WELL GUANGZHOU  
TIANHE R&D CENTER



MEAN WELL GUANGZHOU  
HUADU FACTORY



# KNX Introduction

## What is KNX?

KNX is the only home and building control standard running global certification schemes.



The idea behind KNX is as simple as it is ingenious. KNX combines all main building functions like lighting, shutter control to heating, ventilation, security, energy management and more into one intelligent system. In this system, all devices communicate with one another via a single bus cable which is installed alongside the normal power lines. This means that all electrical functions are connected with one another via the bus system, which helps to lower operational costs resulting in considerable energy savings, to save installation time as well as to increase flexibility and adaptability to future developments.

Source: [www.knx.org](http://www.knx.org)

## Benefits

The MEAN WELL KNX system product is an intelligent solution for networking and controlling building technology. Since the targeted connections of devices and functions comply with the KNX standard, both living and working are not only become more convenient and secure, but also more energy-efficient and economical.



# Indoor Lighting Control & Total Power Solution

The MEAN WELL KNX product range includes components covering the complete applications found in modern buildings, ranging from lighting and shutter control to heating, ventilation and many more. Furthermore, with over 35 years experience of the industrial power supply, MEAN WELL provides a variety of standard power supplies for all kinds of applications such as safety, surveillance, video, audio... etc.

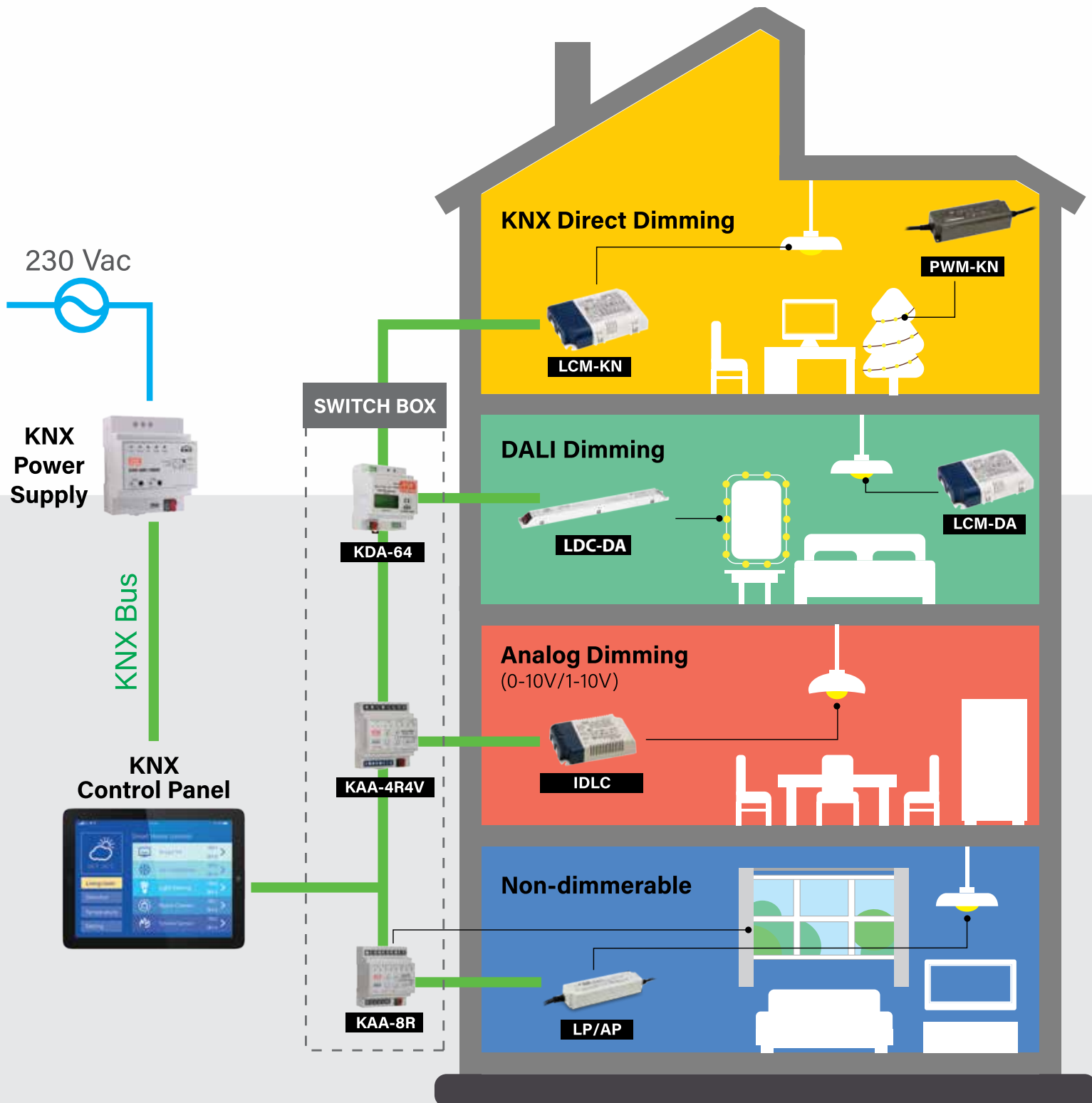

# Product Tree

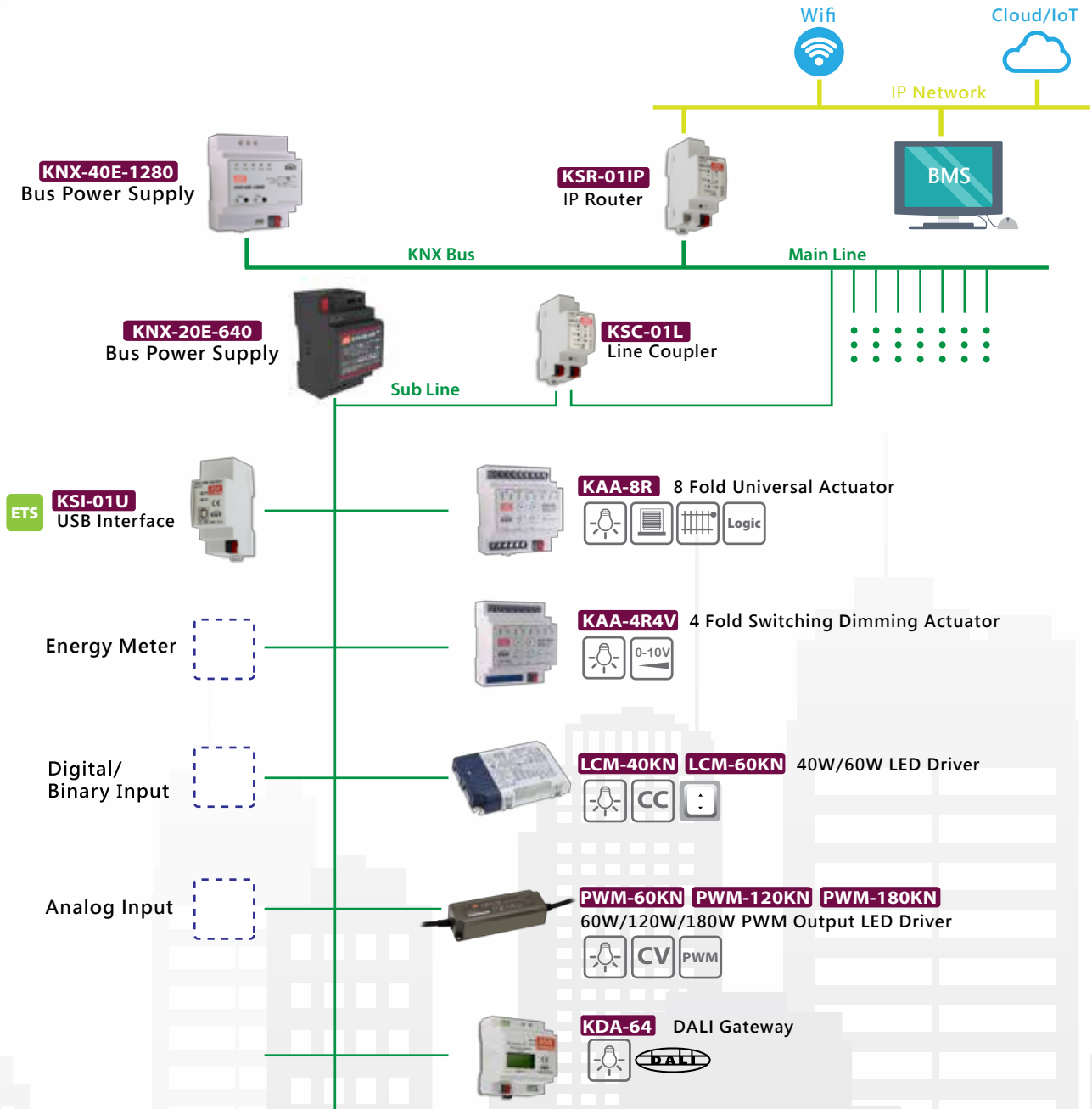

- Under Planning
- Blind/Shutter Control
- Logic Function
- Constant Current Driving Mode
- DC 0-10V Dimming Control
- Lighting Control
- Heating Control
- Push Button Interface
- Constant Voltage Driving Mode
- PWM Style Output Mode



Fast and Multi Language Support for any question of KNX product within 24 hr. For the details please check the last page.



# LCM Series

25~60W KNX Constant Current LED Driver



LCM-KN series is a AC/DC constant current mode output LED driver series featuring the multiple levels selectable by dip switch and the KNX interface to avoid using the complicated KNX-DALI gateway. LCM-KN operates from 180~295VAC and offers different current levels ranging between 350mA and 1400mA.

Thanks to the high efficiency up to 90%, with the fanless design, the entire series is able to operate for -30°C~+90°C case temperature under free air convection. In addition, LCM-KN series is equipped with push dimming and synchronization so as to provide the optimal design flexibility for LED lighting system.



▲ LCM-25KN  
L105x W68x H23mm



▲ LCM-40/60KN  
L123.5x W81.5x H23mm

## Features

- KNX protocol
- Constant current mode output with multiple levels selectable by dip switch
- Support emergency lighting(EL)
- Constant lumen output
- Intergrated KNX push button interface
- Synchronization up to 10 units
- Functions: manual dim, operation hours, log/linear curve selection
- 3 years warranty



## ■ LCM-25/40/60KN

Model No.	Output	Io Tol.	Io Ripple	Effi.
LCM-25KN	350mA~1050mA, 6~54V	±5%	5%(max)	86%
LCM-40KN	350mA~1050mA, 2~100V	±5%	5%(max)	90%
LCM-60KN	500mA~1400mA, 2~90V	±5%	5%(max)	91%

# PWM Series

60~180W KNX Constant Voltage LED Driver



PWM-KN series is an AC/DC LED driver featuring the constant voltage mode with PWM style 12V & 24V output controlled directly via KNX. The entire series is able to operate for -40°C~90 °C case temperature with its minimal dimming level low to 0.5% and user changeable output frequency up to 4KHz to complaint IEEE 1789-2015 flickering requirement.



▲ **PWM-60KN**  
L150x W53x H35mm



▲ **PWM-120KN**  
L191x W63x H37.5mm

## Features

- KNX protocol
- Constant Voltage PWM style output with user changeable frequency up to 4KHz
- Plastic housing with class II design
- Built-in active PFC function
- Standby power consumption <0.5W
- Typical lifetime >50000hours
- 5 years warranty



### ■ PWM-60/120KN

Model No.	Output	Tol.	Effi.
PWM-60-12□	12V, 0~5A	±4%	86%
PWM-60-24□	24V, 0~2.5A	±3%	89%
PWM-120-12□	12V, 0~10A	±4%	88%
PWM-120-24□	24V, 0~5A	±4%	90%

□=KNX/KNBST KN: KNX control technology ; KNBST: KNX control technology with BST14 connector

## PWM-180KN Series 180W PWM Output KNX LED Driver

Under Development

- Constant voltage PWM style output with user changeable frequency
- Plastic housing with class II design
- Built-in active PFC function
- No load power consumption <0.5W / standby power consumption <0.5W
- KNX data secure version
- Typical lifetime >50000 hours
- 5 years warranty



# KAA Series

## KNX Actuator



### KNX Universal Actuator

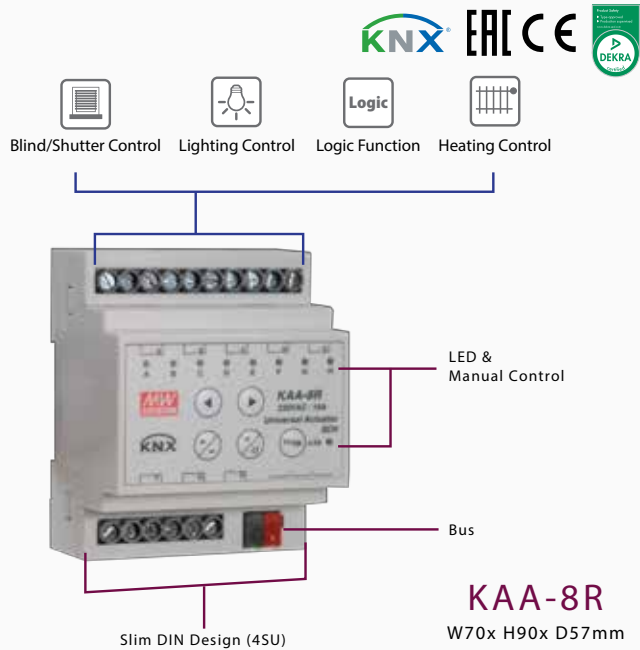

#### Features

- 8 channel actuator in a compact size
- Suitable for various and mixed applications
- For AX, C-load, capacitive & inductive of loads
- **Capacitive load 220µF**
- Manual control via panel Push button
- 3 years warranty

Model No.	Channel	Rating current/channel
KAA-8R	8-Fold	16A
KAA-8R-10	8-Fold	10A

### KNX Dimming Actuator

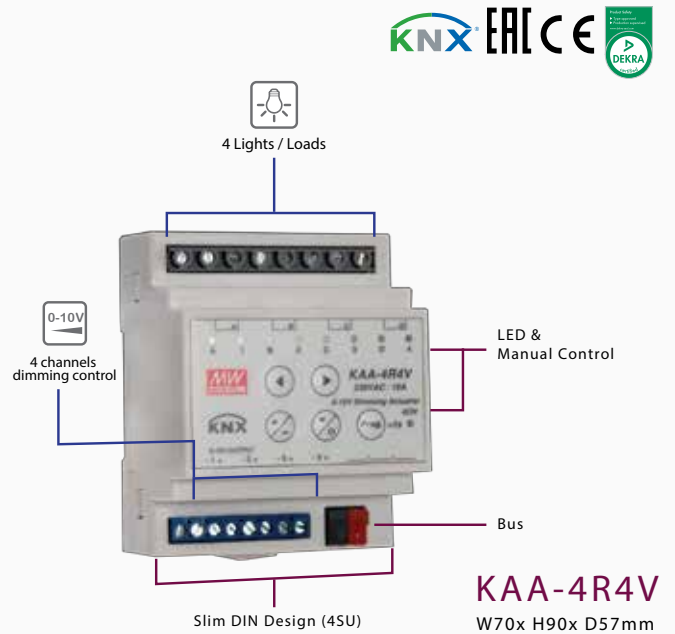

#### Features

- Dimming and switching LED driver and conventional electronic ballast
- **Capacitive load 220µF**
- Linear or logarithmic dimming curve programmable via ETS software
- Programmable various time and scene function
- 3 years warranty

Model No.	Channel	Rating current/channel
KAA-4R4V	4-Fold	16A
KAA-4R4V-10	4-Fold	10A

## KAA-4R4V Wiring Examples

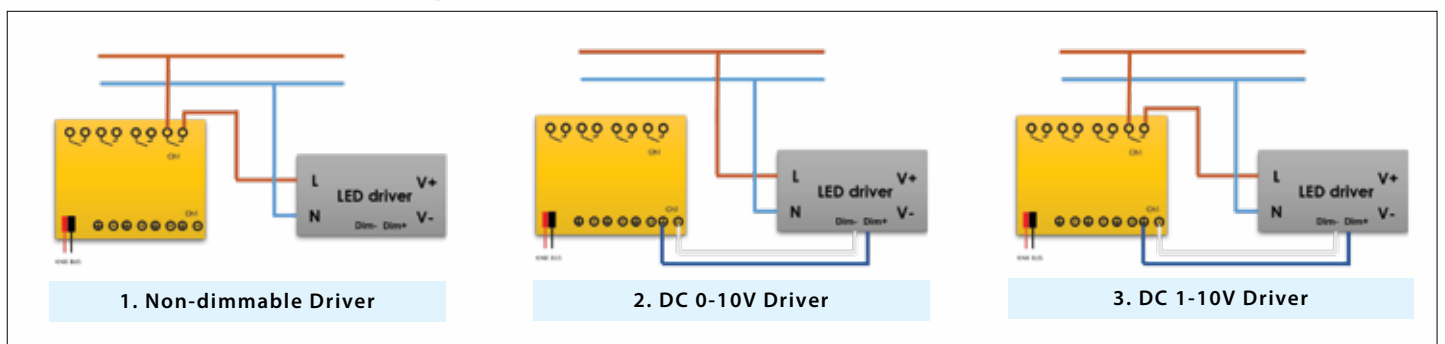



# KNX Series

## 640mA & 1280mA Bus Power Supply



### 640mA Bus Power Supply

**KNX-20E-640** is a 640mA power supply with high efficiency and a small footprint of only 3SU (52.5 mm). The device has a KNX bus choke output and an additional output for ancillary power. LED indicators are used in normal operation, overload conditions and RESET operation. It is perfectly suitable to power up any products labeled with the KNX trademark. KNX-20E-640 is engineered to be a reliable and safe solution for KNX bus environment.



### 1280mA Bus Power Supply

**KNX-40E-1280** is a 1280mA power supply with high efficiency and a small footprint of only 4SU(72mm). The device has a KNX bus choke output and an additional output for ancillary power. LED indicators are used in normal operation, overload conditions and RESET operation. It is perfectly suitable to power up any products labeled with the KNX trademark. KNX-40E-1280 is engineered to be a reliable and safe solution for KNX bus environment.



#### Features

- EIB / KNX power supply with Integrated choke
- Compact size with 3SU/4SU width
- Safety extra low voltage (SELV)
- 180~264VAC input
- No load power consumption <0.5W
- Protections:  
Short circuit / Overload (short-circuit-proof) /  
Over voltage

- Cooling by free air convection
- Isolation class I
- LED indicator for normal operation, bus reset and bus overload
- Installed on DIN rail TS-35/7.5 or 15
- Over voltage category III
- Wide operating temperature: -30~+70°C
- 3 years warranty

Model No.	V <sub>out1</sub> (with choke)	V <sub>out2</sub> (without choke)	I <sub>out</sub> (I <sub>1</sub> +I <sub>2</sub> )
KNX-20E-640	Bus, 30VDC	30VDC	640mA

Model No.	V <sub>out1</sub> (with choke)	V <sub>out2</sub> (without choke)	I <sub>out</sub> (I <sub>1</sub> +I <sub>2</sub> )
KNX-40E-1280 <input type="checkbox"/>	Bus, 30VDC	30VDC	1280mA

: Blank, D ; Blank= Basic function, D=Diagnostic function

# System Component / Inrush Current Limiter



## DALI Gateway



### KDA-64

W86x H72x D55mm



#### Features

- Connect up to 64 DALI ECGs/Drivers
- Built-in DALI power supply
- Lighting control via the integrated web server
- 3 years warranty

## USB Interface



### KSI-01U

W36x H90x D71mm



#### Features

- No additional power supply required
- KNX commissioning addressing and parameters settings
- Long messages support up to 220 byte APDU
- 3 years warranty

## IP Router



### KSR-01IP

W36x H90x D71mm



#### Features

- KNX IP/TP routing
- Built-in web server
- KNX IP secure (optional)
- 3 years warranty

## Line Coupler



### KSC-01L

W36x H90x D71mm



#### Features

- KNX TP Line coupler/Repeater
- Telegram filtering function
- Long messages support up to 240 byte APDU
- 3 years warranty

## Inrush Current Limiter



### ICL-16R

W35x H94x D54.5mm



### ICL-16L

W175x H42x D24mm

#### Features

- Increase the capacitive load to 2500 $\mu$ F max.
- 23A inrush current limiting, 16A continuous
- Integrated by pass relay, no simple NTC
- R:DIN Rail type ; L: Terminal block type

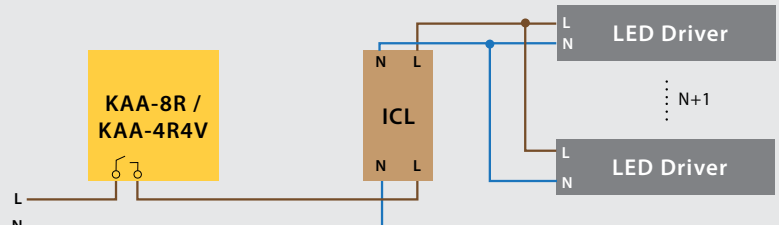

# HDR Series

## 15~150W Ultra Slim Step Shape Power Supply



### Features

- Ultra slim design with 15U~6SU width
- Universal input 85~264VAC(277VAC operational)
- No load power consumption<0.3W
- Isolation class **II**
- Pass LPS (Limited power source)
- DC output voltage adjustable
- Protections : Short circuit / Overload / Over voltage
- Cooling by free air convection (working temperature:-30~+70°C)
- DIN rail TS-35/7.5 or 15 mountable
- Over voltage category **III**
- LED indicator for power on
- 3 years warranty



▲ **HDR-15**  
L17.5x W90x D54.5mm



▲ **HDR-30**  
L35x W90x D54.5mm



▲ **HDR-60**  
L52.5x W90x D54.5mm



▲ **HDR-100**  
L70x W90x D54.5mm



▲ **HDR-150**  
L105x W90x D54.5mm

### ■ HDR-15

Model No.	Output	Tol.	R&N	Effi.
HDR-15-5	5V, 0~2.40A	±2%	80mV	80%
HDR-15-12	12V, 0~1.25A	±1%	120mV	85%
HDR-15-15	15V, 0~1.00A	±1%	120mV	85.5%
HDR-15-24	24V, 0~0.63A	±1%	150mV	86%
HDR-15-48	48V, 0~0.32A	±1%	240mV	87%

### ■ HDR-30

Model No.	Output	Tol.	R&N	Effi.
HDR-30-5	5V, 0~3.0A	±2%	80mV	82%
HDR-30-12	12V, 0~2.0A	±1%	120mV	88%
HDR-30-15	15V, 0~2.0A	±1%	120mV	89%
HDR-30-24	24V, 0~1.5A	±1%	150mV	89%
HDR-30-48	48V, 0~0.75A	±1%	240mV	90%

### ■ HDR-60

Model No.	Output	Tol.	R&N	Effi.
HDR-60-5	5V, 0~6.5A	±2%	80mV	85%
HDR-60-12	12V, 0~4.5A	±1%	120mV	88%
HDR-60-15	15V, 0~2.0A	±1%	120mV	89%
HDR-60-24	24V, 0~1.5A	±1%	150mV	90%
HDR-60-48	48V, 0~0.75A	±1%	240mV	91%

### ■ HDR-100

Model No.	Output	Tol.	R&N	Effi.
HDR-100-12	12V, 0~7.1A	±2%	120mV	88%
HDR-100-12N	12V, 0~7.5A	±2%	120mV	88%
HDR-100-15	15V, 0~6.13A	±1%	120mV	89%
HDR-100-15N	15V, 0~6.5A	±1%	120mV	89%
HDR-100-24	24V, 0~3.83A	±1%	150mV	90%
HDR-100-24N	24V, 0~4.2A	±1%	150mV	90%
HDR-100-48	48V, 0~1.92A	±1%	240mV	90%
HDR-100-48N	48V, 0~2.1A	±1%	240mV	90%

HDR-100: 92W max., pass LPS

HDR-100-xxN: 100W max., non-LPS with a wide output adjustable range

### ■ HDR-150

Model No.	Output	Tol.	R&N	Effi.
HDR-150-12	12V, 0~11.3A	±2%	100mV	89%
HDR-150-15	15V, 0~9.5A	±1%	120mV	89.5%
HDR-150-24	24V, 0~6.25A	±1%	150mV	90.5%
HDR-150-48	48V, 0~3.2A	±1%	200mV	90.5%

**Taiwan** (Headquarters)

**MEAN WELL ENTERPRISES CO., LTD.**

No. 28, Wuquan 3rd Road, Wugu District,

New Taipei City, Taiwan, 24891

**Tel** +886-2-2299-6100(rep.)

**Fax** +886-2-2299-6200(rep.) +886-2-2298-0818(sales)

**e-mail** info@meanwell.com

**Web** www.meanwell.com

**U.S.A.**

**MEAN WELL USA, INC.**

44030 Fremont Blvd., Fremont, CA 94538, U.S.A.

**Tel** +1-510-683-8886

**Fax** +1-510-683-8899

**e-mail** info@meanwellusa.com **Web** www.meanwellusa.com

**Europe**

**MEAN WELL EUROPE B.V.**

Langs de Werf 8, 1185XT Amstelveen, the Netherlands

**Tel** +31-20-758-6000

**Fax** +31-20-758-6001

**e-mail** info@meanwell.eu **Web** www.meanwell.eu

**China**

**MEAN WELL (GUANGZHOU) ELECTRONICS CO., LTD.**

No.11, Jingu South Road, Huadong Town, Huadu District,

Guangzhou, Guangdong, China

**Tel** +86-20-3773-7100 / 400-800-3608(sales)

+86-10-5200-1817(Beijing Office)

+86-755-2359-1630(Shengzhen Office)

**R&D Center**

2F, A Building, Yuean Industry Park, Huangcun,

Dongpu Town, Tianhe District, Guangzhou, China

Post Code: 510660

**Tel** +86-20-2887-1200(rep.)

**Fax** +86-20-8201-0507

**e-mail** info@meanwell.com.cn **Web** www.meanwell.com.cn

**SUZHOU MEAN WELL TECHNOLOGY CO., LTD.**

No.77, Jian-Min Rd. Dong-Qiao, Pan-Yang Ind. Park, Huang-Dai

Town, Xiang-Cheng District, Suzhou, Jiang-Su, China

**Tel** +86-512-6508-8600

**Fax** +86-512-6508-8700

**e-mail** info@meanwell.cc **Web** www.meanwell.cc



**info@meanwell.com**  
**www.meanwell.com**  
**building.meanwell.com**

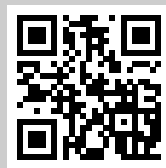

For service, repairs and telephone support, you can talk to one of our in-house employees. This ensures that you receive specialist advice. You won't simply end up in a call center!

**中文** 任何KNX 產品疑問24小時內快速回覆

**簡體中文** 任何KNX 产品疑问24小时内快速回覆

**GERMAN** Schneller Support für jegliche KNX-Produkt Fragen innerhalb von 24 Stunden.

**ENGLISH** Fast support for any question of KNX Product within 24h.

**FRENCH** Assistance rapide pour toute question relative aux produits KNX en 24 heures maximum.

**SPANISH** Soporte rápido para cualquier pregunta de los productos KNX en 24 horas.

**DUTCH** Wij bieden snelle ondersteuning voor al uw KNX-productvragen binnen 24 uur.

**ITALIAN** Supporto rapido per qualsiasi richiesta sui nostri prodotti KNX entro 24 ore.

**POLISH** Szybkie wsparcie dla dowolnego pytania dotyczącego produktu KNX w ciągu 24 godzin.



**MEAN WELL**  
Website

