

# Optical Modulation Analysis Software

## OM1106 Software Datasheet

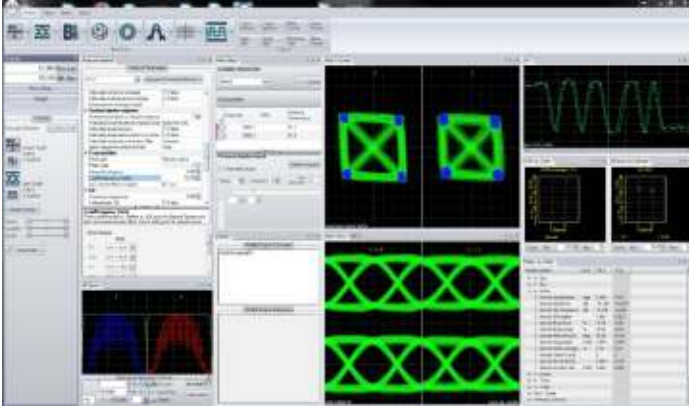

The OM1106 Optical Modulation Analysis (OMA) software provides an ideal platform for research and testing of coherent optical systems. It is a complete software package for acquiring, demodulating, analyzing, and visualizing complex modulated systems from an easy-to-use interface. The software performs all calibration and processing functions to enable real-time burst-mode constellation diagram display, eye-diagram display, Poincaré sphere, and bit-error detection. Advanced users can take advantage of the provided MATLAB signal analysis source code and modify the signal processing algorithms while still taking advantage of the rich user interface for acquisition, signal visualization, and numerical measurements.

### Key features

- Complete coherent signal analysis system for polarization-multiplexed QPSK, QAM, differential BPSK/QPSK, and other advanced modulation formats
- Displays constellation diagrams, phase eye diagrams, Q-factor, Q-plot, spectral plots, Poincaré Sphere, signal versus time, laser phase characteristics, BER, with additional plots and analyses available through the MATLAB interface<sup>1</sup>
- Simultaneously displays data from multiple OMAs at same or different wavelengths, simplifying multi-channel measurements
- Simultaneously calibrates, deskews, and controls multiple OMAs
- Measures polarization mode dispersion (PMD) of arbitrary order with most polarization multiplexed signals
- Smart polarization separation follows signal polarization
- User access to internal functions with a direct MATLAB interface
- Remote access available through Ethernet

<sup>1</sup> MATLAB is a registered trademark of The MathWorks, Inc.

- Superior user interface offers comprehensive visualization for ease-of-use combined with the power of MATLAB
- Includes new coherent receiver S-parameter measurement solution. (OM2210 with new fast-tuning laser required)
- Superchannel configuration allows user to define number of channels, channel frequency, and channel modulation format
- Test automation acquires complete measurements at each channel
- Integrated measurement results allow easy channel-to-channel comparisons

### Introduction

A common thread through the Tektronix OM-series coherent optical products is the OM1106 Optical Modulation Analysis (OMA) Software. This software is included with all Tektronix OM4000-series optical modulation analyzers and is also available as a stand-alone software package for customers to use with their own optical analyzers or as a coherent optical research tool.

The OMA software consists of a number of major building blocks. At the heart of the software is a complete library of analysis algorithms. These algorithms have not been re-purposed from the wireless communications world: they are specifically designed for coherent optical analysis, executed in a customer-supplied MATLAB installation.

The OM1106 software also has a complete applications programmatic interface (API) to the application measurement and analysis algorithms, letting you perform detailed analysis of complex modulated optical signals without requiring any knowledge of MATLAB, analysis algorithms, or software programming.

Flexibility is a key strength of the OM1106 software. You can take measurements solely through the OMA software user interface, you can use the programmatic interface to and from MATLAB for customized processing, or you can do both by using the OMA software as a visualization and measurement framework around which you build your own custom processing.

Software version 3.0 introduces a new multi-OMA software architecture where all operations can be applied across multiple OMAs. This is an ideal solution for multi-mode MIMO research or work on multi-channel systems requiring simultaneous data acquisition.

## OMA user interface

The OMA software has displays for all of the standard coherent optical visualizations such as eye diagrams, constellation diagrams, Poincaré spheres, and so on. The software also provides a complete measurement suite to numerically report key measurements. Constellation measurements include IQ Offset, IQ Imbalance, elongation, real and imaginary bias, magnitude, phase angle, EVM, and others. Eye diagram measurements include many key time domain metrics such as Q-factor, eye height, overshoot, undershoot, risetime, falltime, skew, and crossing point.

OMA software showing 2-carrier 64-QAM 32-GBd analysis. The carriers can be captured simultaneously or sequentially.

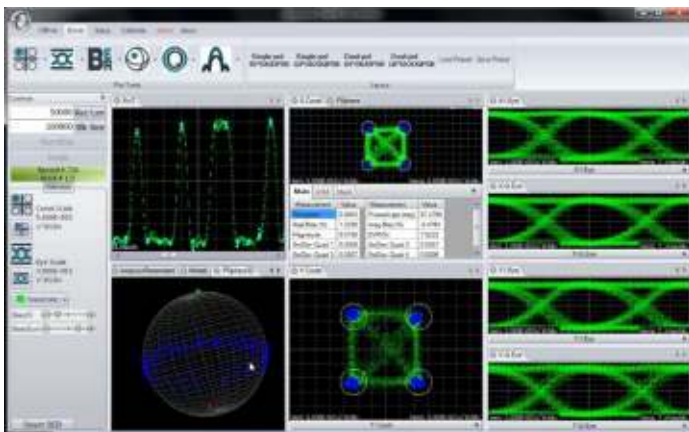
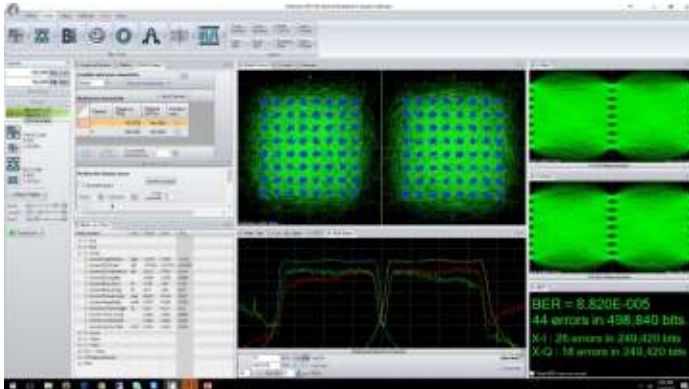

OMA showing several equivalent-time measurement plots.

## Get up and running fast with the easy-to-use OMA interface

The OMA software lets you easily configure and display your measurements and also provides software control for customer test automation using WCF or .NET communication. The software can also be controlled from MATLAB or LabVIEW.

The following image shows a QAM measurement setup. The plots can be moved, docked, or resized within the application work space or into separate windows on the desktop. You can display or close plots to show just the information you need.

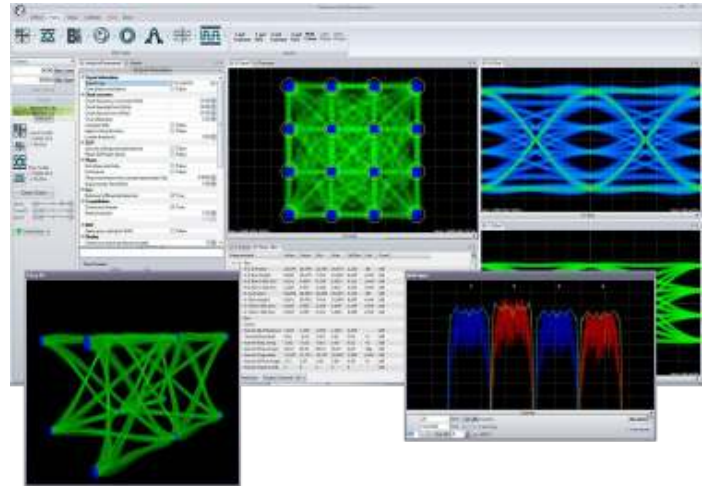

QAM measurements on the OMA software.

In addition to the numerical measurements provided on individual plots, the Measurements tab provides a summary of all numeric measurements, including statistics.

Measurement	Value	Mean	Min	Max	StdDev	Unit	Count
<b>X - Eye</b>							
... X-Q Q-Factor	24.061	23.61702	22.427	24.763	0.58863	dB	52
... X-Q Eye Height	3.042	2.90963	2.783	3.042	0.11522	√mW	52
... X-Q Rail 0 Std Dev	0.104	0.09953	0.085	0.122	0.00730	√mW	52
... X-Q Rail 1 Std Dev	0.087	0.09249	0.080	0.103	0.00588	√mW	52
... X-I Q-Factor	23.711	23.36730	22.568	24.563	0.45167	dB	52
... X-I Eye Height	3.064	2.94771	2.811	3.085	0.12143	√mW	52
... X-I Rail 0 Std Dev	0.096	0.09929	0.078	0.115	0.00877	√mW	52
... X-I Rail 1 Std Dev	0.104	0.10119	0.084	0.120	0.00873	√mW	52
<b>Y - Eye</b>							
<b>X - Const</b>							
... Xconst Quadrature...	3.697	4.21963	3.259	4.835	0.32670	deg	52
... Xconst IQ Offset	-33.537	-33.60336	-38.451	-31.037	1.34148	dB	52
... Xconst IQ Imbalance	0.112	0.11823	0.079	0.159	0.01938	dB	52
... Xconst Elongation	0.987	0.98648	0.982	0.991	0.00220		52
... Xconst Bias, Real	2.35	2.3289	1.33	3.28	0.4343	%	52
... Xconst Bias, Imag	1.83	1.8199	0.97	2.58	0.4211	%	52
... Xconst Phase Angle	93.70	94.2196	93.26	94.84	0.3267	deg	52
... Xconst Magnitude	2.166	2.07437	1.985	2.167	0.08622	√mW	52
... Xconst EVM, Average	7.08	7.1479	6.76	7.67	0.1949	%	52
... Xconst Mask Violat...	0	0.00	0	0	0.00		52
... Xconst Symbols Dis...	942	942.00	942	942	0.00		52
... Xconst Symbol Std...	0.003	0.00262	0.002	0.003	0.00015	√mW	52
<b>Y - Const</b>							
<b>X - Trans</b>							
<b>Y - Trans</b>							
<b>Pow - Trans</b>							
<b>XY Measurements</b>							
... Sig Freq Offset	-165.7	5.470	-271.7	270.9	174.339	MHz	52
... Signal BaudRate	12.00	12.0001	12.00	12.00	0.0001	GHz	52

The Measurements tab- a summary of all measurements in one place

### Make measurements faster

The OMA software is designed to collect data from the oscilloscope and move it into the MATLAB workspace with extreme speed to provide the maximum data refresh rate. The data is then processed in MATLAB to extract and display the resulting measurements.

### Take control with tight MATLAB integration

Since 100% of the data processing occurs in MATLAB, test engineers can easily probe into the processing to understand each step along the way. R&D labs can also take advantage of the tight MATLAB integration by writing their own MATLAB algorithms for new techniques under development.

### Use the optimum algorithm

Don't worry about which algorithm to use. When you select a signal type in the OMA software (for example, PM-QPSK), the application applies the optimal algorithm for that signal type to the acquired data. Each signal type has a specially designed signal processing approach optimized for that signal. This means that you get results right away.

### Don't get stymied by laser phase noise

Signal processing algorithms designed for electrical wireless signals don't always work well with the much noisier sources used for complex optical modulation signals. Our robust signal processing methods tolerate enough phase noise to make it possible to test signals that would traditionally be measured by differential or direct detection such as DQPSK.

### Find the right BER

Q-plots are a great way to get a handle on your data signal quality. Numerous BER measurements versus decision threshold are made on the signal after each data acquisition. Plotting BER versus decision threshold shows the noise properties of the signal. Gaussian noise will produce a straight line on the Q-plot. The optimum decision threshold and extrapolated BER are also calculated. This gives you two BER values: the actual counted errors divided by the number of bits counted, as well as the extrapolated BER for use when the BER is too low to measure quickly.

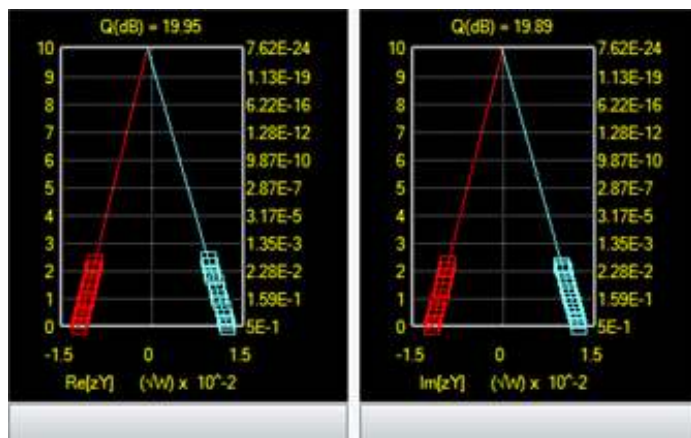

Q-plot.

### Constellation diagrams

Once the laser phase and frequency fluctuations are removed, the resulting electric field can be plotted in the complex plane. When only the values at the symbol centers are plotted, this is called a Constellation Diagram. When continuous traces are also shown in the complex plane, this is often called a Phase Diagram. Since the continuous traces can be turned on or off, we refer to both as the Constellation Diagram.

The scatter of the symbol points indicates how close the modulation is to ideal. The symbol points spread out due to additive noise, transmitter eye closure, or fiber impairments. The scatter can be measured by symbol standard deviation, error vector magnitude, or mask violations.

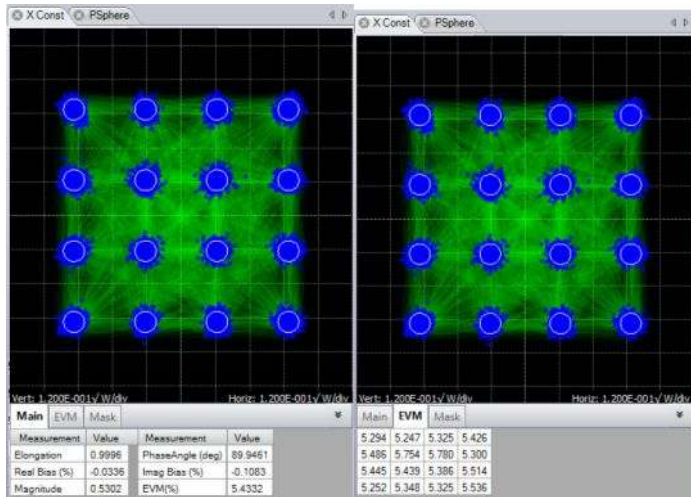

Constellation diagram.

### Constellation measurements

Measurements made on constellation diagrams are available on the “fly-out” panel associated with each graphic window. The measurements available for constellations are described below.

#### Constellation measurements

Measurement	Description
Elongation	The ratio of the Q modulation amplitude to the I modulation amplitude is a measure of how well balanced the modulation is for the I and Q branches of a particular polarization’s signal
Real Bias	Expressed as a percent, this says how much the constellation is shifted left or right. Real (In-phase) bias other than zero is usually a sign that the In-phase Tributary of the transmitter modulator is not being driven symmetrically at eye center
Imag Bias	Expressed as a percent, this says how much the constellation is shifted up or down. Imaginary (Quadrature) bias other than zero is usually a sign that the Quadrature Tributary of the transmitter modulator is not being driven symmetrically at eye center
Magnitude	The mean value of the magnitude of all symbols with units given on the plot. This can be used to find the relative sizes of the two Polarization Signals
Phase Angle	The transmitter I-Q phase bias. It should normally be 90
StdDev by Quadrant	The standard deviation of symbol point distance from the mean symbol in units given on the plot. This is displayed for BPSK and QPSK
EVM (%)	The RMS distance of each symbol point from the ideal symbol point divided by the magnitude of the ideal symbol expressed as a percent

Measurement	Description
EVM Tab	The separate EVM tab shown in the right figure provides the EVM% by constellation group. The numbers are arranged to correspond to the symbol arrangement. This is ideal for setting Transmitter modulator bias. For example, if the left side groups have higher EVM than the right side, adjust the In-phase Transmitter modulator bias to drive the negative rail harder
Mask Tab	The separate Mask tab shown in the right figure provides the number of mask violations by constellation group. The numbers are arranged to correspond to the symbol arrangement. The mask threshold is set in the Engine window and can be used for pass/fail transmitter testing
Quadrature Error	The deviation of the transmitter IQ phase from 90 degrees.
IQ Offset	The ratio between the carrier leakage power and the signal power in dB. This metric is impacted by Quadrature Error, Real and Imaginary bias.
IQ Imbalance	The ratio of the real and imaginary constellation size in dB. It is related to the linear measure, Elongation.

### Color features

The Color Grade feature provides an infinite persistence plot where the frequency of occurrence of a point on the plot is indicated by its color. This mode helps reveal patterns not readily apparent in monochrome. Note that the lower constellation groups of the example below have higher EVM than the top groups. In most cases this indicates that the quadrature modulator bias was too far toward the positive rail. This is not evident from the crossing points which are approximately correct. In this case an improperly biased modulator is concealing an improperly biased driver amp.

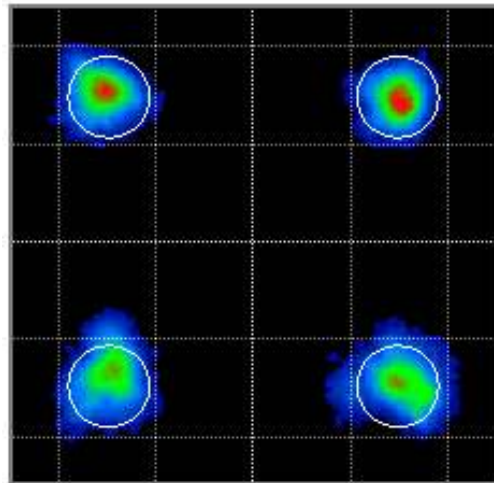

Color Grade Constellation.

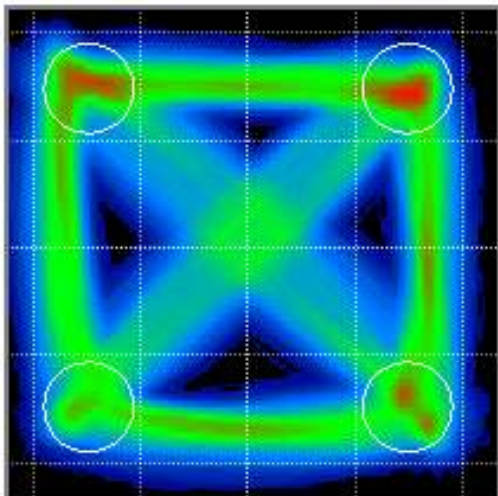

Color Grade with fine traces.

Color Key Constellation Points is a special feature that works when not in Color Grade. In this case the symbol color is determined by the value of the previous symbol. If the prior symbol was in Quadrant 1 (upper right) then the current symbol is colored Yellow. If the prior symbol was in Quadrant 2 (upper left) then the current symbol is colored Magenta. If the prior symbol was in Quadrant 3 (lower left) then the current symbol is colored Light Blue (Cyan). If the prior symbol was in Quadrant 4 (lower right) then the current symbol is colored Solid Blue.

This helps reveal pattern dependence. The following figure shows that pattern dependence is to blame for the poor EVM on the other groups. In QPSK modulation, the modulator nonlinearity would normally mask this type of pattern dependence due to RF cable loss, but here the improper modulator bias allows that to be transferred to the optical signal.

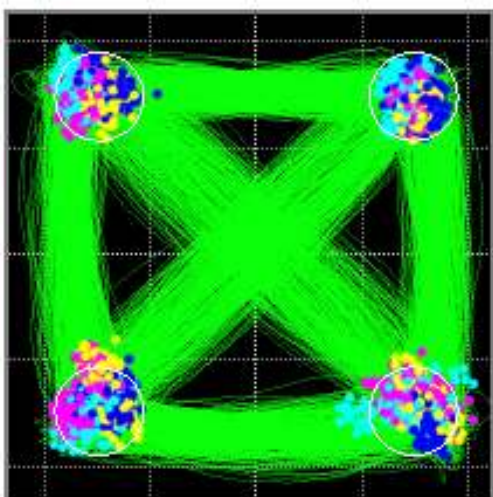

Color Key constellation

## Eye diagrams

Eye diagram plots can be selected for appropriate modulation formats. Supported eye formats include Field Eye (the real part of the phase trace in the complex plane), Power Eye (which simulates the eye displayed with a Tektronix oscilloscope optical input), and Diff-Eye (which simulates the eye generated by using a 1-bit delay-line interferometer). As with the Constellation Plot you can right-click to choose color options as well.

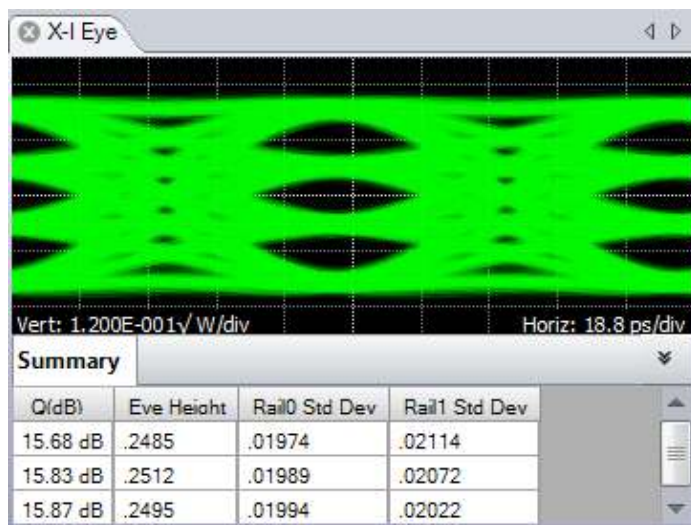

Field eye diagram.

## Field eye measurements

Measurement	Description
Q (dB)	Computed from $20 \times \text{Log}_{10}$ of the linear decision threshold Q-factor of the eye
Eye Height	The distance from the mean 1-level to the mean 0-level (units of plot)
Rail0 Std Dev	The standard deviation of the 0-level as determined from the decision threshold Q-factor measurement
Rail1 Std Dev	The standard deviation of the 1-level as determined from the decision threshold Q-factor measurement

In the case of multilevel signals, the above measurements are listed in the order of the corresponding eye openings in the plot. The top row values correspond to the top-most eye opening.

The above functions involving Q-factor use the decision threshold method described in the paper by Bergano<sup>2</sup>. When the number of bit errors in the measurement interval is small, as is often the case, the Q-factor derived from the bit error rate may not be an accurate measure of the signal quality. However, the decision threshold Q-factor is accurate because it is based on all the signal values, not just those that cross a defined boundary.

<sup>2</sup> N.S. Bergano, F.W. Kerfoot, C.R. Davidson, "Margin measurements in optical amplifier systems," IEEE Phot. Tech. Lett., 5, no. 3, pp. 304-306 (1993).

### Additional measurements available for nonoffset formats

Measurement	Description
Overshoot	The fractional overshoot of the signal. One value is reported for the tributary, and for a multilevel (QAM) signal it is the average of all the overshoots
Undershoot	The fractional undershoot of the signal (overshoot of the negative-going transition)
Risetime	The 10-90% rise time of the signal. One value is reported for the tributary, and for a multilevel (QAM) signal it is the average of all the rise times
Falltime	The 90-10% fall time of the signal
Skew	The time relative to the center of the power eye of the midpoint between the crossing points for a particular tributary
Crossing Point	The fractional vertical position at the crossing of the rising and falling edges

### Measurements versus Time

In addition to the eye diagram, it is often important to view signals versus time. For example, it is instructive to see what the field values were doing in the vicinity of a bit error. All of the plots that display symbol-center values will indicate if that symbol errors by coloring the point red (assuming that the data is synchronized to the indicated pattern). The Measurement versus Time plot is particularly useful to distinguish errors due to noise, pattern dependence, or pattern errors.



Errored symbol (red dot) in Measurement versus Time plot.

### 3D visualization tools

Complex-modulation signals are inherently 3D since in-phase and quadrature components are being changed versus time. The 3D Eye Diagram provides a helpful combination of the Constellation and Eye diagrams into a single 3D diagram. This helps to visualize how the complex quantity is changing through the bit period. The diagram can be rotated and scaled.

Also available in 3D is the Poincaré Sphere. The 3D view is helpful when viewing the polarization state of every symbol. The symbols tend to form clusters on the Poincaré Sphere which can be revealing to expert users. The non-normalized Stokes Vectors can also be plotted in this view.

### Analysis Controls

The various Analysis Control tabs in the OMA software let you set parameters for the system and relevant measurements.

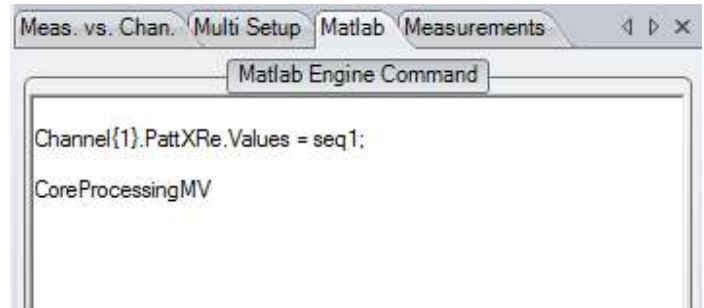

MATLAB tab.

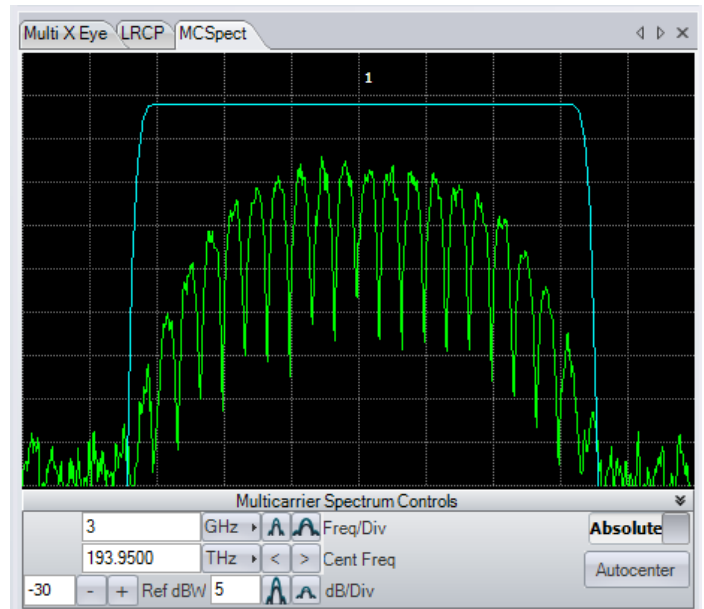

Signal Spectrum tab.

### Analysis Parameters tab setting types

Parameter	Description
Frequency	Clock recovery is performed in software, so only a frequency range of expected clock frequencies is required
Signal Type	The signal type (such as PM-QPSK) determines the algorithm used to process the data
Data Patterns	Specifying the known PRBS or user pattern by physical tributary permits error counting, constellation orientation, and two-stage phase estimation

You can assign user data patterns in the MATLAB tab. The data pattern can be input into MATLAB or found directly through measurement of a high SNR signal.

### Signal spectra

An FFT of the corrected electric field versus time can reveal much about the data signal. Asymmetric or shifted spectra can indicate excessive laser frequency error. Periodicity in the spectrum shows correlation between data tributaries. The FFT of the laser phase versus time data can be used to measure laser phase noise.

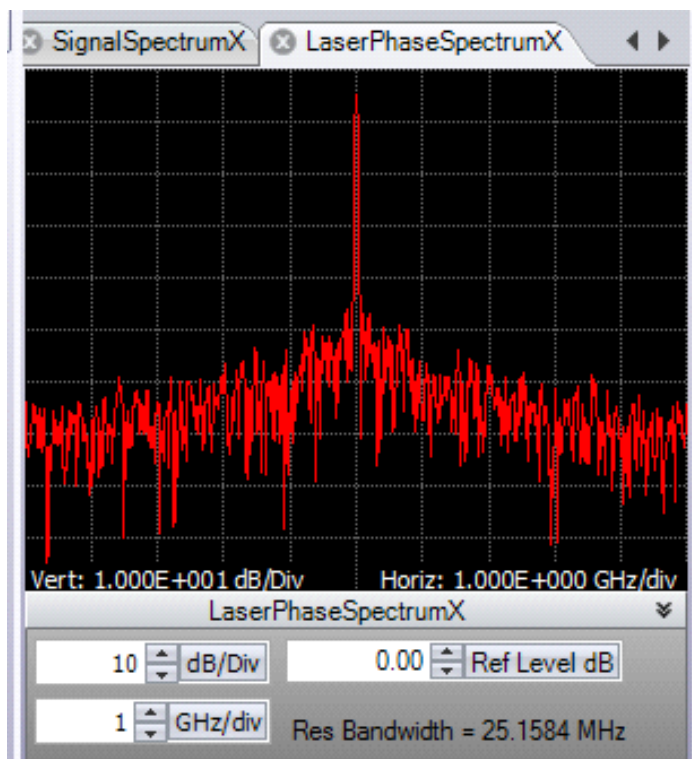

Laser Phase Spectrum window

### Poincaré Sphere

Polarization data signals typically start out well aligned to the PM-fiber axes. However, once in standard single mode fiber, the polarization states will start to drift. However, it is still possible to measure the polarization states and determine the polarization extinction ratio. The software locks on each polarization signal. The polarization states of the two signals are displayed on a circular plot representing one face of the Poincaré sphere. States on the back side are indicated by coloring the marker blue. The degree of orthogonality can be visualized by inverting the rear face so that orthogonal signals always appear in the same location with different color. So, Blue means back side (negative value for that component of the Stokes vector), X means X-tributary, O means Y-tributary, and the Stokes vector is plotted so that left, down, blue are all negative on the sphere.

InvertedRearFace – Checking this box inverts the rear face of the Poincaré sphere display so that two orthogonal polarizations will always be on top of each other.

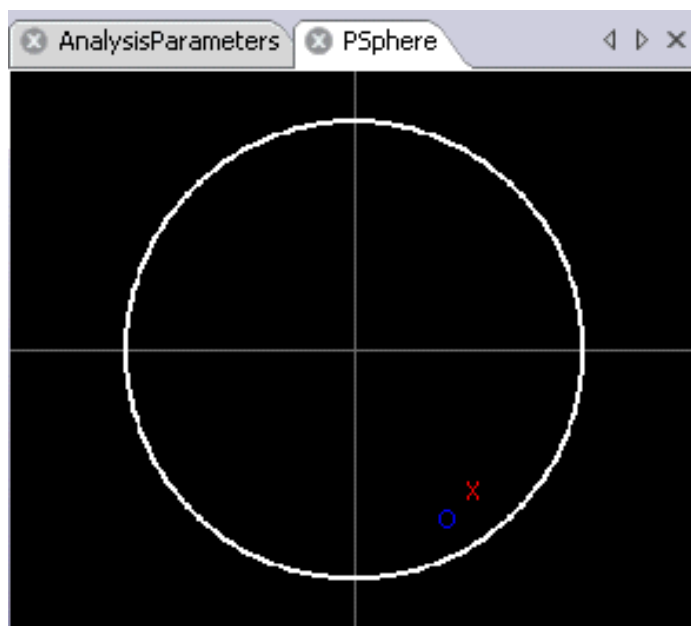

Poincaré Sphere window.

## Impairment measurement and compensation

When studying transmission implementations, it is important to be able to compensate for the impairments created by long fiber runs or optical components. Chromatic Dispersion (CD), and Polarization Mode Dispersion (PMD) are two important linear impairments that can be measured or corrected by the OMA software. PMD measurement is based on comparison of the received signal to the back-to-back transmitter signal or to an ideal signal. This produces a direct measure of the PMD instead of estimating based on adaptive filter behavior. You can specify the number of PMD orders to calculate. Accuracy for 1st-order PMD is ~1 ps at 10 Gbaud. There is no intrinsic limit to the CD compensation algorithm. It has been used successfully to compensate for many thousands of ps/nm.

## Recording and playback

You can record the workspace as a sequence of .MAT files using the Record button in the Offline ribbon. These files are recorded in a default directory, usually the MATLAB working directory, unless previously changed. You can play back the workspace from a sequence of .MAT files by first using the Load button in the Offline Commands section of the Home ribbon. Load a sequence by marking the files you want to load using the Ctrl key and marking the filenames with the mouse. You can also load a contiguous series using the Shift key and marking the first and last filenames in the series with the mouse. Use the Run button in the Offline Commands section of the Home ribbon to cycle through the .MAT files you recorded. All filtering and processing you have implemented occurs on the recorded files as they are replayed.



Workspace record and playback.

## Multi-carrier and multi-OMA support

Even as 100G and 200G coherent optical systems are being deployed, architectures for 400G, 1T, and beyond are being proposed and developed. Two important approaches include the “superchannel” and spatial-division multiplexing on few-mode or multi-core fibers. The configurations of superchannels vary, while optical MIMO systems are still in the research phase. Clearly, flexible test tools are needed for such next-generation systems.

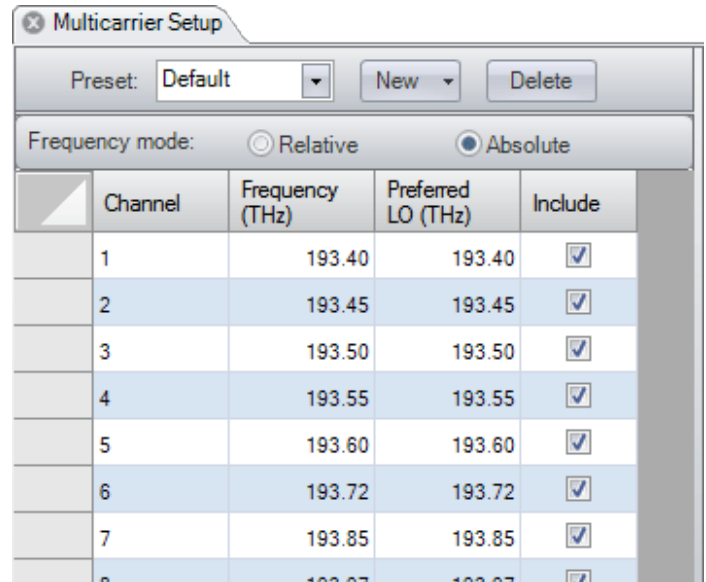

Multi-carrier setup.

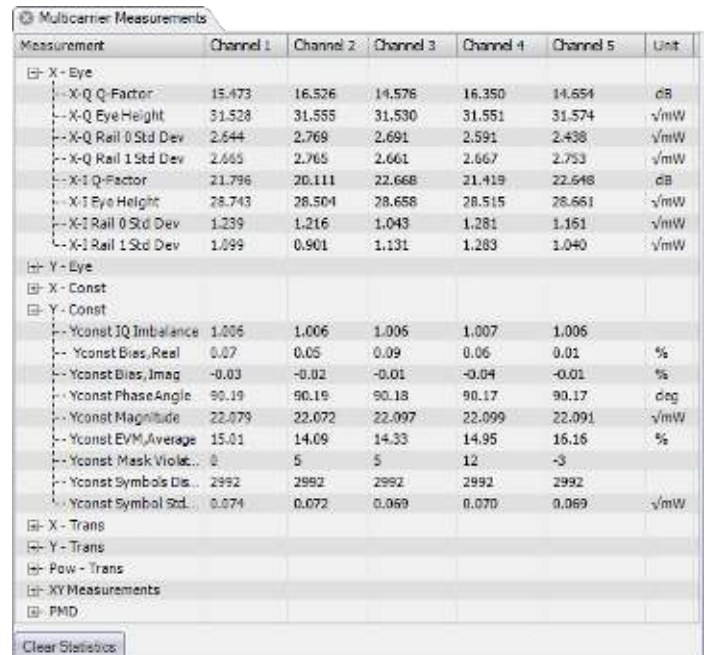

Multi-carrier measurements.



## User-definable superchannels

For manufacturers getting a jump on superchannels, or researchers investigating alternatives, user-definable superchannel configurations are a must. The multicarrier lets you set up as many carriers within the superchannel definition as necessary. Each carrier can have an arbitrary center frequency; no carrier grid spacing is imposed. The carrier center frequencies can be set as absolute values (in THz) or as relative values (in GHz).

Typically, the application software retunes the OM4245 local oscillator for each carrier. However, in cases where multiple carriers will fit within the oscilloscope bandwidth, multiple carriers can be demodulated in software from a common local oscillator frequency. This provides the flexibility to specify the preferred local oscillator frequency for each carrier.

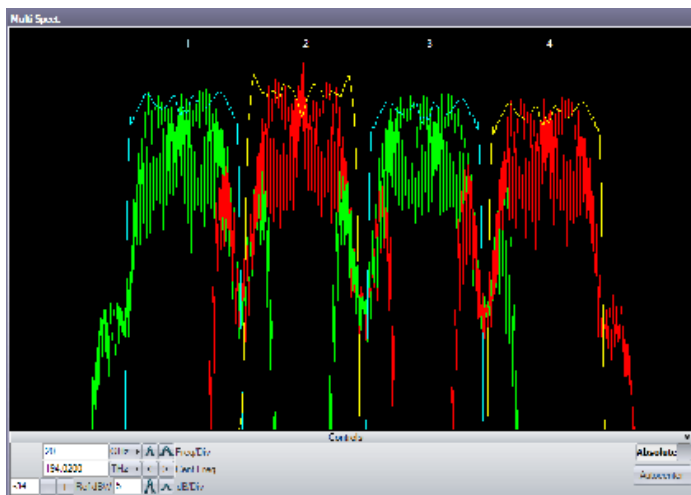

Superchannel spectrum.

For software version 3.x the channels may also span multiple Optical Modulation Analyzers. This facilitates simultaneous recovery of widely spaced carriers or separate spatial channels. The data is simultaneously acquired and analyzed from the OMAs and presented in the multi-channel analysis plots. The simultaneously collected data also resides in the Matlab Engine using cell-array variables. These data may be used by researchers to do their own multi-channel signal processing.

## Automated measurements

Once the superchannel is configured, the OMA software can take measurements on each channel without further intervention. The software automatically tunes the OM4245 local oscillator, takes measurements at that channel, re-tunes to the next channel, and so on, until measurements of the entire superchannel have been taken. Results of each channel are displayed in real-time and persist after all measurements are made for easy comparison.

## Integrated measurement results

All of the same measurement results that are made for single channels are also available for individual channels in a superchannel configuration. Additionally, multi-carrier measurement results are available side-by-side for comparison between channels. Visualizations such as eye diagrams, constellation diagrams, and optical spectrum plots can be viewed a single channel at a time, or with all channels superimposed for fast comparison.

For separating channels in a multi-carrier group, several different filters can be applied, including raised cosine, Bessel, Butterworth, Nyquist, and user-defined filters. These filters can be any order or roll-off factor and track the signal frequency.

## Coherent optical signal generation

Tektronix offers several signal generation instruments capable of generating coherent optical waveforms. The AWG70000 Series Arbitrary Waveform Generators (AWG) and the PPG3000 Series Programmable Pattern Generators offer the flexibility to choose the signal generator best suited to your test requirements.

The AWG70000 Series can reach sampling rates as high as 50 GS/s with 10 bits vertical resolution. This level of performance allows for the direct generation of IQ baseband signals required by modern coherent optical communication systems. The arbitrary waveform generation capabilities of the AWG70000 Series makes it possible to create multi-level signals such as 16QAM or 64QAM, add impairments to a signal, or create waveforms that are pre-compensated for the real-world effects of the test system.

Coherent optical signal generation is one of the more demanding applications for an AWG. The requirements in terms of number of channels, sampling rate, bandwidth, record length, and timing and synchronization quality can be only met by the highest performance instruments, such as the Tektronix AWG70000 series. The unique capability of generating ideal or distorted signals, and the ease to add new modulation schemes and signal processing algorithms without the need to add any extra hardware, make Tektronix AWGs an ideal tool for coherent optical communication research and development.

The PPG3000 Series can generate patterns up to 32 Gb/s and offers 1, 2, or 4 channels in a single instrument. The patterns can be standard PRBS patterns or user-defined. Using a 4-channel pattern generator makes creating dual-polarization I-Q waveforms very simple.

## Receiver test

The OMA software can perform many of the coherent receiver measurements specified in the OIF Implementation Agreements and elsewhere. These measurements include:

- Small signal bandwidth, including:
  - Absolute magnitude frequency response
  - Relative I/Q and X/Y magnitude response
  - Relative I/Q and X/Y phase response
- P/N, I/Q and X/Y skew
- Total harmonic distortion
- Image rejection ratio
- Quadrature phase error
- IQ; XY gain imbalance
- IQ phase error
- O/E frequency response

Relevant measurements are a function of wavelength. In order to optimize test time, you can specify the start and stop wavelengths, the step size, and a wide range of other parameters. The Wavelength Sweep can also produce a calibration file that is used by software to correct for coherent receiver impairments, when the receiver is part of a Tektronix Optical Modulation Analyzer system.

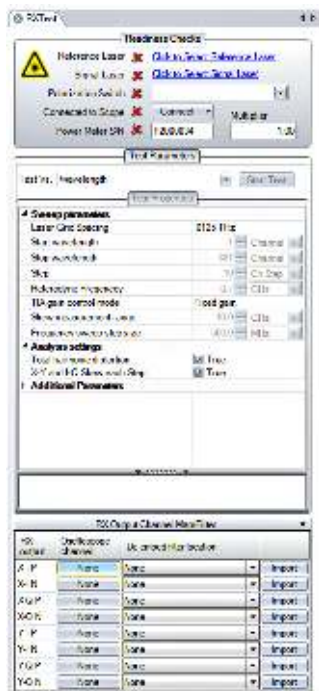

Test results are displayed both graphically and numerically based upon the user's preference. Some receiver test measurements require the use of the OM2210 Receiver Calibration Source. The new software version 3.0 software supports the faster tuning laser now available in the OM2210. With the fast tuning laser, coherent receiver characteristics can be measured in a matter of minutes.

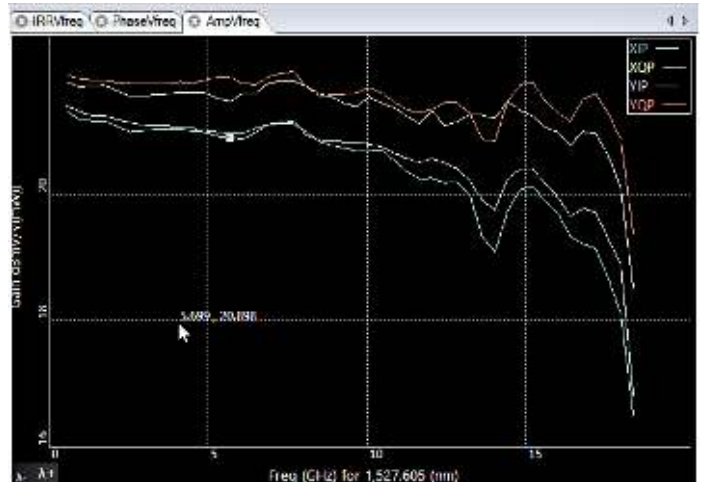

## Interaction between OMA and MATLAB

The OMA software takes information about the signal provided by the user together with acquisition data from the oscilloscope and passes them to the MATLAB workspace. A series of MATLAB scripts are then called to process the data and produce the resulting field variables. The software then retrieves these variables and plots them. Automated tests can be accomplished by connecting to the OMA software or by connecting directly to the MATLAB workspace.

You do not need any familiarity with MATLAB; the OMA software can manage all MATLAB interactions. However, advanced users can access the MATLAB interface internal functions to create user-defined demodulators and algorithms, or for custom analysis visualization.

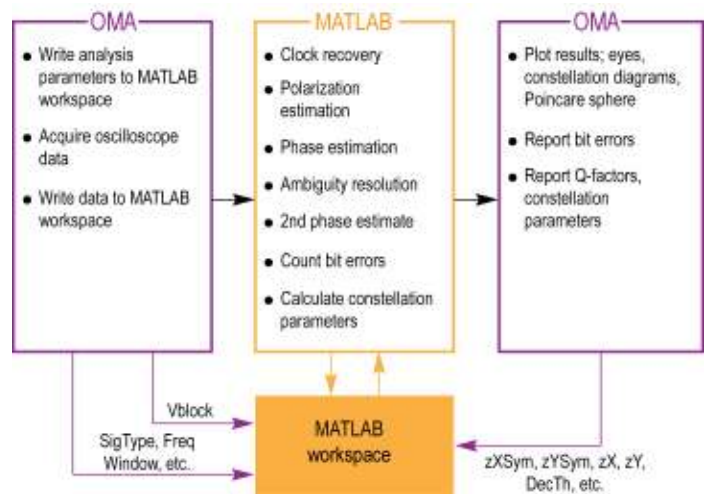

OMA software/MATLAB data flow

## Signal processing approach

For real-time sampled systems, the first step after data acquisition is to recover the clock and retime the data at 1 sample per symbol at the symbol center for the polarization separation and following algorithms (shown as upper path in the figure). The data is also re-sampled at 10X the baud rate (user settable) to define the traces that interconnect the symbols in the eye diagram or constellation (shown as the lower path).

The clock recovery approach depends on the specified signal type. Laser phase is then recovered based on the symbol-center samples. Once the laser phase is recovered, the modulation part of the field is available for alignment to the expected data for each tributary. At this point bit errors can be counted by looking for the difference between the actual and expected data after accounting for all possible ambiguities in data polarity. The software selects the polarity with the lowest BER. Once the actual data is known, a second phase estimate can be done to remove errors that may result from a laser phase jump. Once the field variables are calculated, they are available for retrieval and display by the OMA software.

At each step the best algorithms are chosen for the specified data type, requiring no user intervention unless desired.

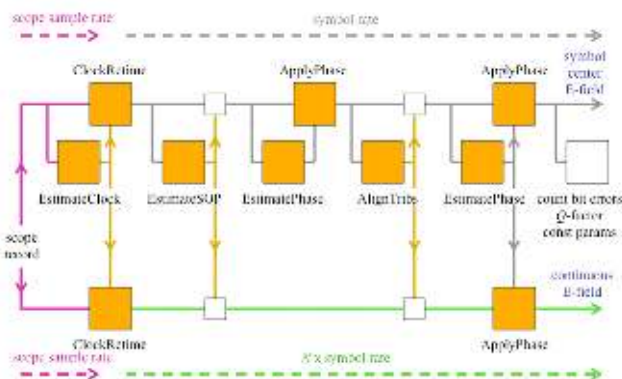

Data flow through the "Core Processing" engine.

## Signal processing customization

The OM1106 software includes the MATLAB source code for the "CoreProcessing" engine (certain proprietary functions are provided as compiled code). You can customize the signal processing flow, or insert or remove processes as desired. Alternatively, you can remove all Tektronix processing and completely replace it with your own. By using the existing variables defined for the data structures, you can then see the results of analysis processing using the rich visualizations provided by the OMA software. This lets you focus your time on algorithms rather than on tasks such as acquiring data from the oscilloscope or displaying constellation diagrams.

## Dynamic MATLAB integration

Customizing the CoreProcessing algorithms provides an excellent way to conduct signal processing research. In order to speed up development of signal processing the OM1106 software provides a dynamic Matlab integration window. Any Matlab code typed in this window is executed on every pass through the signal processing loop. This lets you quickly add or "comment out" function calls, write specific values into data structures, or modify signal processing parameters on the fly, without needing to stop the processing loop or modify the Matlab source code.

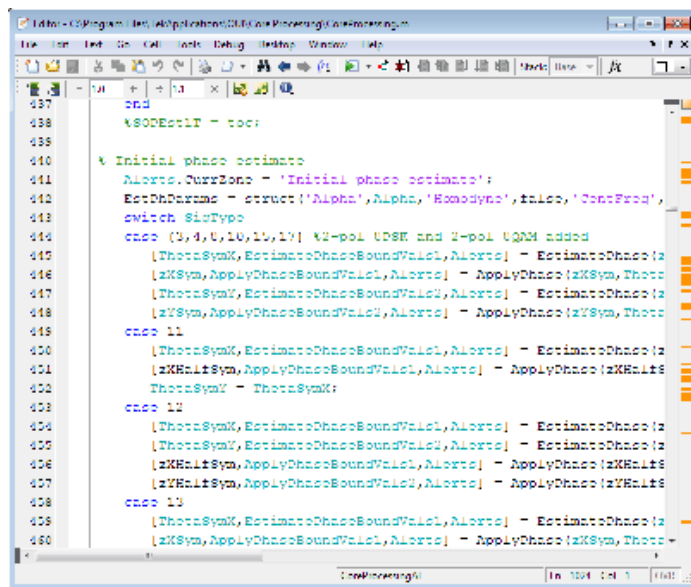

## CoreProcessing functions

The following are some of the CoreProcessing functions used to analyze the coherent signal. Full details on these functions, their use in the processing flow, and the MATLAB variable used, are available in the OM1106 user manual.

- **EstimateClock** determines the symbol clock frequency of a digital data-carrying optical signal based on oscilloscope waveform records. The scope sampling rate may be arbitrary (having no integer relationship) compared to the symbol rate.
- **ClockRetime** forms an output parameter p, representing a dual-polarization signal versus time, from four oscilloscope waveforms V. The output p is retimed to be aligned with the timing grid specified by Clock.
- **EstimateSOP** reports the state of polarization (SOP) of the tributaries in the optical signal. The result is provided in the form of an orthogonal (rotation) matrix RotM. For a polarization multiplexed signal the first column of RotM is the SOP of the first tributary, and the second column the SOP of the second tributary. For a single tributary signal, the first column is the SOP of the tributary, and the second column is orthogonal to it. The signal is transformed into its basis set (the tributaries horizontal vertical polarizations) by multiplying by the inverse of RotM.

- **EstimatePhase** estimates the phase of the optical signal. The algorithm used is known to be close to the optimal estimate of the phase. The algorithm first determines the heterodyne frequency offset and then estimates the phase. The phase reported in the .Values field is after the frequency offset has been subtracted.
- **ApplyPhase** multiplies the values representing a single or dual polarization parameters versus time by a phase factor to give a resulting set of values.
- **AlignTlibs** performs ambiguity resolution. The function acts on variable which is already corrected for phase and state of polarization, but for which the tributaries have not been ordered. AlignTlibs uses the data content of the tributaries to distinguish between them. AlignTlibs processes the data patterns in order according to the modulation format, starting with X-I. For each pattern it tries to match the given data pattern with the available tributaries of the signal. If the same pattern is used for more than one tributary, the relative pattern delays will be used to distinguish between them.

The use of delay as a secondary condition to distinguish between tributaries means that AlignTlibs will work with transmission experiments that use a single data pattern generator which is split several ways with different delays. The delay search is performed only over a limited range of 1000 bits in the case of PRBS patterns, so this method of distinguishing tributaries will not usually work when using separate data pattern generators programmed with the same PRBS.
- **Spect** estimates the power spectral density of the optical signal using a discrete Fourier transform. It can take any many of our time waveforms as input such as corrected oscilloscope input data, front-end processed data, polarization separated data, averaged data, and FIR data. It can also apply Hanning or Flat-Top window filters and produce the desired resolution bandwidth over a set frequency range.
- **GenPattern** generates a sequence of logical values, 0s and 1s, given an exact data pattern. The exact pattern specifies not only the form of the sequence but also the place it starts and the data polarity. The data pattern specified may be a pseudo-random bit sequence (PRBS) or a specified sequence.
- **LaserSpectrum** estimates the power spectral density of the laser waveform in units of dBc. The function LaserSpectrum takes ThetaSym, the estimated relative laser phase sampled at the symbol rate, as input and defines the frequency centered laser waveform. This waveform is then scaled by a hamming window, and the power spectral density of the waveform is estimated as the discrete Fourier transform of this signal.
- **QDecTh** uses the decision threshold method to estimate the Q-factor of a component of the optical signal. The method is useful because it quickly gives an accurate estimate of Q-factor (the output signal-to-noise ratio) even if there are no bit errors, or if it would take a long time to wait for a sufficient number of bit errors.

## Supported measurements and display tools

**Note:** Most features require a real-time oscilloscope.

Characteristic	Description
Multi-channel Eye	Displays coherent eye diagrams for each channel in a multi-channel measurement.
Multi-channel measurements	Displays all numerical measurements by channel.
Multi-carrier spectrum	Displays the spectra collected on each channel and each OMA of a multi-channel measurement.
EVM versus Channel and Q versus	Channel plots graphical display these measurements versus channel number.
Multi-channel Constellation	Displays the Constellation Diagram for each channel of a multi-channel measurement.
Constellation Diagram	Constellation diagram accuracy including intradyne and demodulation error can be measured by the RMS error of the constellation points divided by the magnitude of the electric field for each polarization signal
Constellation Elongation	Ratio of constellation height to width
Constellation Phase Angle	Measure of transmitter IQ phase angle
Constellation I and Q Bias	Measure of average symbol position relative to the origin
IQ Offset	The ratio between the carrier leakage power and the signal power in dB. This metric is impacted by Quadrature Error, Real and Imaginary bias
IQ Imbalance	The ratio of the real and imaginary constellation size in dB. It is related to the linear measure, Elongation
Quadrature Error	The deviation of the transmitter IQ phase from 90 degrees
Constellation Mask	User-settable allowed EVM level. Symbols violating the mask are counted
Eye Decision Threshold Q-factor	The actual Q achieved will depend on the quality of the data signal, the signal amplitude, and the oscilloscope used for digitalization
Decision Threshold Q-plot	Displays BER versus decision threshold for each eye opening. The Q value at optimum decision threshold is the Q-factor
Frequency response	The normalized power output from each receiver channel when excited by two optical fields with a given frequency difference (a given heterodyne frequency)
3-dB point	The frequency at which the response of a receiver channel has fallen by 3 dB relative to its response near zero frequency
Image rejection ratio	The ratio between the power in the negative (image) and positive frequency components in the receiver output when excited by a signal with positive frequency
Common mode rejection ratio	A measure of the departure from the ideal behavior of the differential, balanced photodetectors in a receiver
Channel skew	The relative time delay between the signals output from each channel of a receiver
Phase error	The departure of the phase angle between I and Q signals near zero frequency from the ideal value of 90°
Phase response	The I-Q phase difference as a function of frequency
Phase skew	The linear part of the phase response
Phase distortion	The phase response after subtracting the phase skew
Total harmonic distortion	The ratio between the power in higher harmonics of the output signal to the power in the fundamental frequency when excited by a sinusoidal input
Relative gain	Ratios between the frequency response of different channels
Amplitude	The peak-to-peak voltage of the signal output from each channel when excited by a sinusoidal input
Relative amplitude	Ratios between the amplitudes of the signals produced by different channels
Signal Spectrum and Laser Spectrum	Display of signal electric field versus time in the complex plane FFT of power signal or laser phase noise
MATLAB Window	Commands may be entered that execute each time signals are acquired and processed
Measurements versus Time	Pre-defined measurement versus time measurements include Optical field, symbol-center values, errors, and averaged waveforms. Any parameter can be plotted versus time using a custom-created MATLAB expression

Characteristic	Description
3D Measurements	3D Eye (complex field values versus time), and 3D Poincaré Sphere for symbol and tributary polarization display
Differential Eye Diagram Display	Balanced or single-ended balanced detection is emulated and displayed in the Differential Eye Diagram
Frequency Offset	Frequency offset between signal and reference lasers is displayed in Measurement panel
Poincaré Sphere	Polarizations of the Pol-muxed signal tributaries are tracked and displayed on the Poincaré Sphere. PER is measured
Signal Quality	EVM, Q-factor, and mask violations
Tributary Skew	A time offset for each tributary is reported in the Measurement panel
CD Compensation	No intrinsic limit for offline processing – FIR-based filter to remove CD in frequency domain based on a given dispersion value
PMD Measurement	PMD values are displayed in the Measurement panel for Polarization-multiplexed formats with a user-specified number of PMD orders
Oscilloscope and/or Cable Delay Compensation	The OMA software corrects cable, oscilloscope, and receiver skew through interpolation. Additional cable adjustment is available using the oscilloscope UI
Calibration Routines	Receiver Skew, Frequency response, DC Offset, and Path Gain Mismatch Hybrid angle and state of polarization. Receiver frequency response, SOP, gain, and phase angle are factory calibrated.
Data Export Formats	MATLAB (other formats available through MATLAB or ATE interface); PNG
Raw Data Replay with Different Parameter Setting	Movie mode and reprocessing
Bit Error Ratio Measurements	Number of counted bits/symbols
	Number of errors detected
	Bit error ratio
	Differential-detection errors
	Save acquisition on detected error
Offline Processing	Run software on a separate PC or on the oscilloscope
Coherent Eye Diagram	Shows the In-Phase or Quadrature components versus time modulo two bit periods.
Power Eye Diagram	Shows the computed power per polarization vs time modulo 2 bit periods.

## System requirements

Supported platforms for the OM1106 Optical Modulation Analysis (OMA) software:

- Computer with nVidia graphics card running US Windows 10 64-bit and MATLAB 2016a (64-bit)
- Computer with nVidia graphics card running US Windows 7 64-bit and MATLAB version 2011b (64-bit), 2014a (64-bit) or 2016a (64-bit)
- Computer with nVidia graphics card running US Windows XP 32-bit and MATLAB 2009a (32-bit)

The following platforms are supported but may not be able to use certain advanced graphics features such as color grade and 3D:

- Tektronix 70000 Series Oscilloscopes running Windows 7 64-bit and MATLAB 2011b (64-bit)
- Computer with non-nVidia graphics running US Windows 7 64-bit and MATLAB 2011b (64-bit)
- Computer with non-nVidia graphics running US Windows XP 32-bit and MATLAB 2009a (32-bit)

Please check with Tektronix when ordering for the most up-to-date requirements including support for the latest releases of MATLAB software.

Please contact Tektronix for a price quote or to arrange a demonstration. All product descriptions and specifications are subject to change without notice.

---

## Ordering information

### Signal analyzer software

OM1106                      Optical Modulation Analysis software

### OM1106 options

OM1106                      Optical Modulation Analysis (OMA) Software only

OM1106 QAM                Adds QAM and other software demodulators

OM1106 L0                 English manual

OM11UP                     Kits to upgrade existing Optical Modulation Analysis (OMA) Software:

    OM11UP QAM             Adds QAM and other software demodulators

    OM11UP SHIP            Customer Requests Shipment or Export Requirement

OMADDLSW                Adds additional seat of Optical Modulation Analysis (OMA) Software

### Related products

#### 45 GHz Optical Modulation Analyzer

OM4245                     45 GHz Optical Modulation Analyzer (requires choice of lasers):

    OM4245 CC                C-band lasers (receiver tested over C-band)

    OM4245 CL                Coupled C- and L-band lasers (receiver calibrated over C- and L-band)

    OM4245 EXT              Adds external connections for reference laser

    OM4245 MCS              Adds multi-carrier superchannel support

#### 25 GHz Optical Modulation Analyzer

OM4225                     25 GHz Optical Modulation Analyzer (requires choice of lasers)

    OM4225 CC                C-band lasers (receiver tested over C-band)

    OM4225 CL                Coupled C- and L-band lasers (receiver calibrated over C- and L-band)

    OM4225 EXT              Adds external connections for reference laser

    OM4225 MCS              Adds multi-carrier superchannel support

### Coherent optical transmitter

OM5110                     46 GBaud Dual-Polarization Coherent Optical IQ Transmitter

    OM5110 C                 C-band laser factory installed

    OM5110 L                 L-band laser factory installed

    OM5110 NL                No laser installed, requires external laser



## Coherent Receiver Calibration Source

<b>OM2210</b>	33 GHz Coherent Receiver Calibration Source (requires choice of lasers):
<b>OM2210 C</b>	C-Band Coherent Receiver Calibration Source (with single C-band laser)
<b>OM2210 CC</b>	C-Band Coherent Receiver Calibration Source (with two C-band lasers)
<b>OM2210 L</b>	L-Band Coherent Receiver Calibration Source (with single L-band laser)
<b>OM2210 LL</b>	L-Band Coherent Receiver Calibration Source (with two L-band lasers)
<b>OM2210 CL</b>	C + L-Band Coherent Receiver Calibration Source (with coupled C and L lasers)
<b>OM2210 NL</b>	Receiver calibrated over C+L

## C-Band & L-Band laser sources

<b>OM2012</b>	nLaser (requires choice of laser configuration):
<b>OM2012 CC</b>	C-Band nLaser (with two C-band lasers)
<b>OM2012 CL</b>	C + L-Band nLaser (with one C-band laser and one L-band laser)
<b>OM2012 LL</b>	L-Band nLaser (with two L-band lasers)



Tektronix is registered to ISO 9001 and ISO 14001 by SRI Quality System Registrar.



Product Area Assessed: The planning, design/development and manufacture of electronic Test and Measurement instruments.

**ASEAN / Australasia** (65) 6356 3900  
**Belgium** 00800 2255 4835\*  
**Central East Europe and the Baltics** +41 52 675 3777  
**Finland** +41 52 675 3777  
**Hong Kong** 400 820 5835  
**Japan** 81 (3) 6714 3086  
**Middle East, Asia, and North Africa** +41 52 675 3777  
**People's Republic of China** 400 820 5835  
**Republic of Korea** +822 6917 5084, 822 6917 5080  
**Spain** 00800 2255 4835\*  
**Taiwan** 886 (2) 2656 6688

**Austria** 00800 2255 4835\*  
**Brazil** +55 (11) 3759 7627  
**Central Europe & Greece** +41 52 675 3777  
**France** 00800 2255 4835\*  
**India** 000 800 650 1835  
**Luxembourg** +41 52 675 3777  
**The Netherlands** 00800 2255 4835\*  
**Poland** +41 52 675 3777  
**Russia & CIS** +7 (495) 6647564  
**Sweden** 00800 2255 4835\*  
**United Kingdom & Ireland** 00800 2255 4835\*

**Balkans, Israel, South Africa and other ISE Countries** +41 52 675 3777  
**Canada** 1 800 833 9200  
**Denmark** +45 80 88 1401  
**Germany** 00800 2255 4835\*  
**Italy** 00800 2255 4835\*  
**Mexico, Central/South America & Caribbean** 52 (55) 56 04 50 90  
**Norway** 800 16098  
**Portugal** 80 08 12370  
**South Africa** +41 52 675 3777  
**Switzerland** 00800 2255 4835\*  
**USA** 1 800 833 9200

\* European toll-free number. If not accessible, call: +41 52 675 3777

**For Further Information.** Tektronix maintains a comprehensive, constantly expanding collection of application notes, technical briefs and other resources to help engineers working on the cutting edge of technology. Please visit [www.tek.com](http://www.tek.com).

Copyright © Tektronix, Inc. All rights reserved. Tektronix products are covered by U.S. and foreign patents, issued and pending. Information in this publication supersedes that in all previously published material. Specification and price change privileges reserved. TEKTRONIX and TEK are registered trademarks of Tektronix, Inc. All other trade names referenced are the service marks, trademarks, or registered trademarks of their respective companies.

