



Product Specification

Skydel Wavefront

GNSS Simulator for CRPA
Processing Unit Testing

SKYDEL WAVEFRONT

Table of Contents

1. Introduction	3
2. Skydel Simulation Engine	3
1.1. Description	3
3. Wavefront Simulator.....	6
1.1. Architecture.....	6
2.2. Hardware.....	7
3.3. Software.....	11
4. Specification.....	17
5. Available Models.....	18

List of Figures

Figure 1 - Architecture of the Skydel Wavefront Simulator.....	6
Figure 2 - Example of Real-Time Monitor and Correction of the Phase for a Four-Element System.....	7
Figure 3 – Hardware components of the Skydel Wavefront simulator.....	7
Figure 4 - Ettus USRP N310.....	8
Figure 5 – Skydel Semi-Automatic Calibration Tool.....	9
Figure 6 – Simulator node.....	10
Figure 7 – Integration of the Simulator Node in the architecture of the simulator	10
Figure 8 – CRPA Antenna configuration.....	11
Figure 9 – Directional jammer configuration	13
Figure 10 – Illustration of a jammer spectrum and trajectory	13
Figure 11 – Spoofing simulation principle in CRPA testing	14
Figure 12 – Directional spoofer configuration	15
Figure 13 - Illustration of a spoofer spectrum and trajectory	16

1. Introduction

Controlled Reception Pattern Antennas (CRPAs) are becoming increasingly common, particularly in the Defense sector. CRPAs are an extremely effective anti-jam/spoof solution because they adapt dynamically in response to jamming or spoofing signals. It is important to know the direction from which the interference is coming, so that you do not receive that RF power into your GPS receiver. This is done by forming nulls in the direction of the interference, or by using beam forming techniques to isolate and track only the true satellite signals, ignoring the others.

When considering using any new device, it is important to test it prior to fielding – especially in applications like defense, where the stakes are high. It is critical to test these devices rigorously with a proper system that can achieve those testing capabilities.

The wavefront simulation method is the lowest cost option. Industry has only been able to say that for the past couple of years due to advances in simulation technology, thanks to the software defined approach. Previously, simulation testing for CRPAs required very expensive and complex phase matrix equipment. If you have ever considered a wavefront simulator in the past but found it to be too costly or too complicated, it is worth taking another look, because innovation now allows us to make it accessible, efficient and powerful. Simulation also provides the flexibility to cover multiple test cases quickly, and it is conducive to fast iteration speeds.

The purpose of this document is to present the architecture of the Skydel Wavefront simulator, focusing on some key features like Advanced Jamming and Spoofing, and on the Skydel Simulation Engine which is the core software powering the simulator. The last part of the document details the specification of the Skydel Wavefront simulator.

In complement of this specification, we recommend this reading on CRPA testing:

[An Engineering Guide to CRPA Testing](#)

2. Skydel Simulation Engine

This section describes the Skydel Simulation Engine which is the software at the heart of all the “Powered By Skydel” products. The features and performance described here are all part of the Skydel Wavefront simulator.

1.1. Description

Skydel Software

The Skydel GNSS Simulator is a standard computer application that can be used under Microsoft Windows 10 or (preferably) Linux Ubuntu 18.04 LTS. It was designed from the beginning to be very flexible and it can transmit in real-time GNSS digital signals to many kinds of Software-Defined Radios.

Skydel uses Graphics Processing Units (GPUs) to compute, in real-time, the digital GNSS signal of all simulated satellites. With this approach, the performance of the simulator is scalable and thus can be adapted from simple use-cases to the most complex ones. The signal generation engine inside Skydel was built with a focus on high-end performance and flexibility.

Skydel engine features:

- 1000Hz simulation iteration rate
- High-end performance (precision, resolution, ultra-high dynamic motion)
- Hundreds of satellites simulated in real time using off-the-shelf graphic card (GPU)
- GNSS satellite orbit modification and custom fixed position

- Unlimited pseudorange additive ramps
- Navigation message modification/corruption
- On-the-fly scenario re-configuration & raw data logging
- Antenna position, angular offset and patterns
- Hardware In the Loop (HIL) simulation
- Comprehensive and intuitive open source API for multiple Python, C# and C++
- Export user interactions as Python source code to create automated scripts in few clicks

GNSS Signals supported

Skydel can simulate civil signals from the 4 global navigation satellites systems and regional systems (SBAS, QZSS, NAVIC). Moreover, Skydel was designed with a plug-in architecture, which enables the simulation of encrypted or restricted GNSS signals, such as GPS P(Y)-Code, M-Code and PRS. The simulated GNSS signals can also be shaped to represent specific atmospheric models or multipath.

- Four constellations: GPS (open & encrypted), GLONASS, Galileo, BeiDou
- Regional constellations: SBAS, QZSS, NAVIC
- Differential GNSS (DGNSS) and multi-vehicle simulation
- Multipath simulation as well as ionospheric and tropospheric models

Trajectories simulated

Skydel can simulate many kinds of GNSS receiver trajectories. Those trajectories can contain very high dynamics and can be imported into Skydel in different formats.

- 6DoF receiver trajectories
- Import tools: CSV, KML, NMEA, etc.
- Scenario editor with integrated street maps
- Online/offline street maps
- Real-time definition of trajectory (Hardware-In-the-Loop)

Advanced Interference generation module

Generation of simple and complex interference signals is easy with Skydel's "advanced jammers" module. Using a dedicated RF output of an SDR, interference signals can then be mixed to the GNSS signals. The interference can either be in-band or out-of-band and be composed of many waveforms of different power levels.

- Multiple virtual transmitters with user defined trajectories and waveforms
- User-defined waveforms (Chirp, CW, BOC, BPSK, AWGN & pulse modulations combination)
- Transmit arbitrary IQ data from file
- Dynamics are applied to transmitted signals

Advanced Spoofing generation module

Advanced spoofing simulation is a powerful, intuitive tool that enables users to quickly create and automate a multitude of dynamic spoofing scenarios. Oroli's advanced GNSS simulators can simulate both spoofers and repeaters using the same equipment. Complicated test setups are history thanks to the innovative Skydel Advanced Spoofing option. It's no longer necessary to purchase and synchronize multiple simulators or try to use simulator echo functions that were designed for other purposes.

- Simulate multiple spoofers simultaneously

- Each spoofer can generate any GNSS signal
- Each spoofer has an independent trajectory & antenna pattern
- Skydel software automatically determines signal dynamics between each spoofer & receiver antenna
- Full control of navigation message, pseudoranges and time synchronization
- Control truth and spoofed constellations independently for increased flexibility and realism

Signal “store and analyze”

With the Skydel GNSS simulator, it is possible to record the simulated GNSS and interference signals onto a disk in the form of digital IQsample files. This functionality can be very useful to analyze the generated signal with external post-processing tool (ex: Matlab). The analysis can be done directly on the baseband signal, avoiding impairments introduced by the up/down conversion to/from RF (ex: increased noise floor, phase noise of the oscillator, etc..).

Custom Signal

Custom signal is another unique feature allowing the user to define and generate his own GNSS or non-GNSS signals. The signals are injected in real time through a DLL interface provided with Skydel. Main parameters of the signal like frequency, bandwidth, number of ranging code components, sub-carriers are defined in an XML file. The user writes their own C++ source code to generate navigation message, code chips and send this data to the simulator for the signal modulation. The user does not have to worry about the dynamics, the pseudorange, the doppler and the modulation of the signals, as they are managed in the simulator.

3. Wavefront Simulator

This section describes the Skydel Simulation Engine which is the software at the heart of all the “Powered By Skydel” products. The features and performance described here are all part of the Skydel Wavefront simulator.

1.1. Architecture

The system architecture can scale up and down depending on the number of elements and signals, which dictates the number of GPU's, computers, and so forth. The diagram below shows how this works with a Skydel Wavefront simulator.

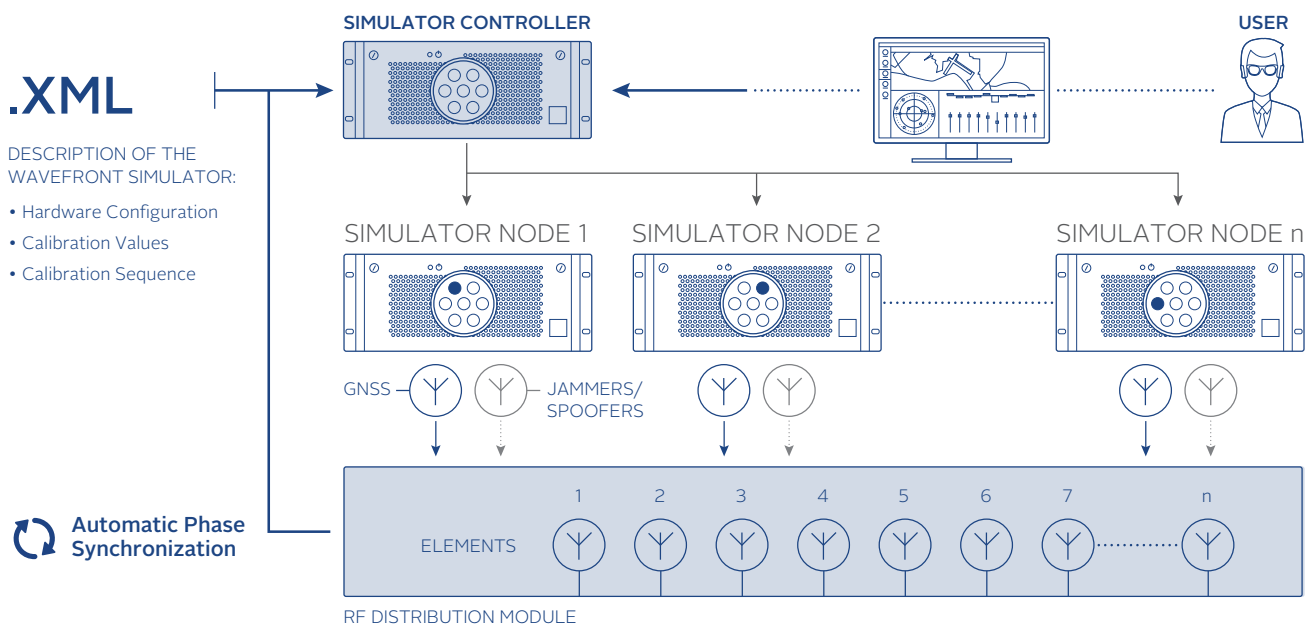

Figure 1 - Architecture of the Skydel Wavefront Simulator

The architecture starts with having simulator nodes. Each node corresponds to an element of the CRPA and is dedicated to simulating all the signals for that specific element. So, if you were to have a seven-element CRPA, you would use seven nodes to accomplish the simulation. Each node simulates the low power GNSS or “truth” signals, as well as the high-power signals such as jammers and spoofers. There are two different RF paths, which allows you to manage a huge dynamic range in power. Then the proper signals are sent to the RF distribution module at the bottom, where they are combined and brought to a specific element. The RF distribution module also provides a feedback loop to the simulator controller.

Simulator Controller and Phase Alignment

The simulator controller is the heart of the system. It controls all the nodes, coordinates them, synchronizes them, and sends commands to simulate the proper phase alignment and dynamics. It is monitoring the combined signal that feeds back to the controller. This allows the controller to measure the phase, compensate and make corrections, all in real-time, to ensure that the phase stays within the specifications of the system. Because this is done continuously during the entire duration of simulation, you can be sure that you stay within specifications regardless of the duration of the simulation.

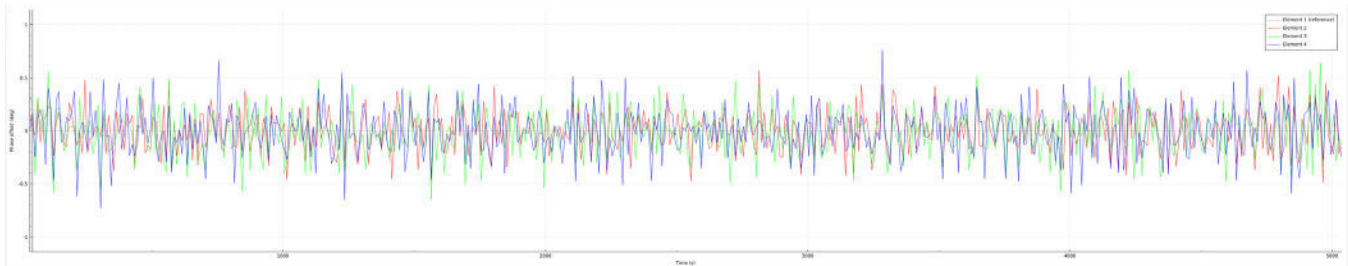

Figure 2 - Example of Real-Time Monitor and Correction of the Phase for a Four-Element System

The simulator controller is also the single point of user interface. All the complex calculations and sequences are happening under the hood, so you can concentrate on what needs to be achieved in terms of testing: defining the scenario, the jammers, spoofers, and so forth. Thanks to the automation, you will not waste any time waiting around. In seconds, special algorithms compute the phase difference between each pair of elements. In less than a minute, your entire system is calibrated and ready to go.

2.2. Hardware

Skydel Wavefront simulators are tailored solutions that are designed to fit the customer specifications. However, the building blocks are always the same and are described below.

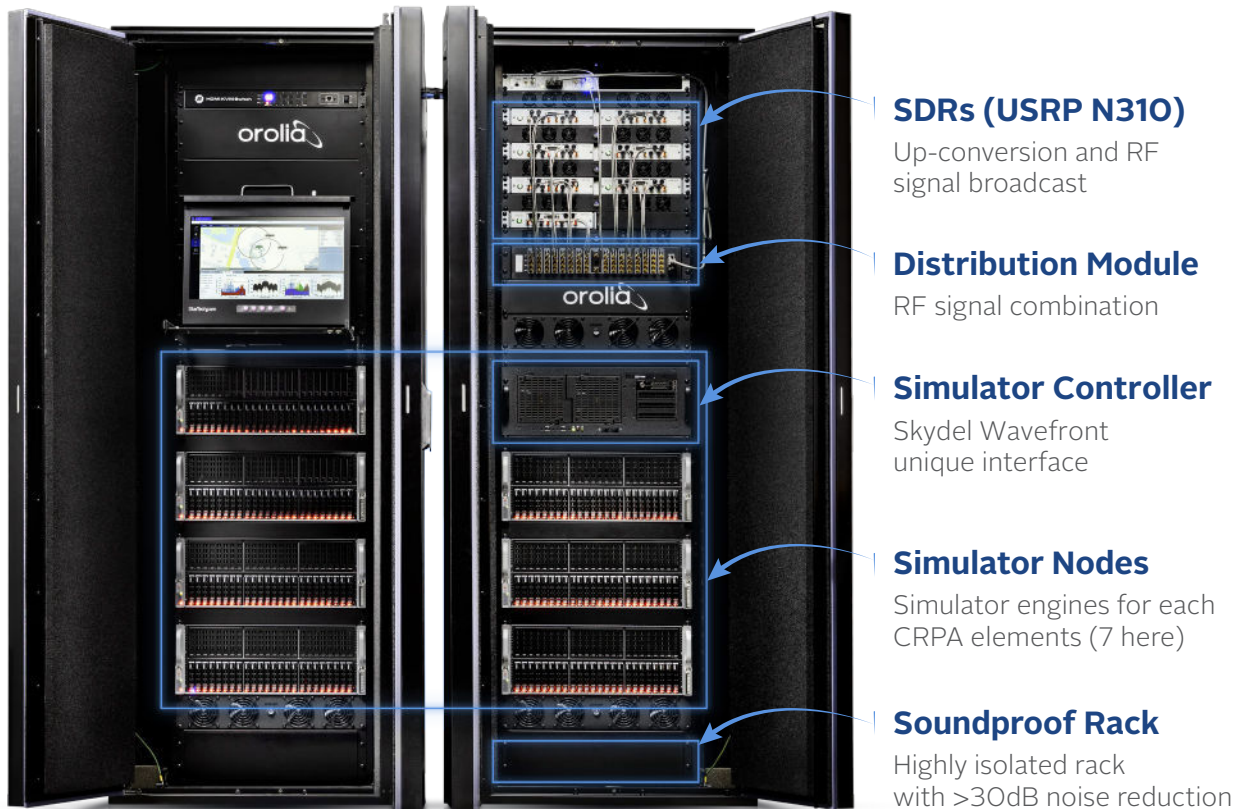

Figure 3 – Hardware components of the Skydel Wavefront simulator

For example, the following table describes a typical high-level BOM for a Skydel Wavefront simulator with:

- 4 bi-frequencies antenna elements
- All the GNSS constellations (GPS, Galileo, BeiDou, GLONASS)
- Hundreds of jammers and 2 spoofers

Item	Qty
Computer "Simulator Controller" including: <ul style="list-style-type: none"> • 1 medium-end GPU 	1
Computer "Simulator Node" including: <ul style="list-style-type: none"> • 2 high-end GPUs • 10Gb Ethernet cards 	4
N310 SDR	4
X300 SDR	2
EC20S reference clock	1
Wavefront Distribution Module	1
Acoustic rack	1

Software Defined Radios (ETTUS USRP N310)

The Wavefront simulator leverages the properties of the Ettus USRP radios. In Skydel, the USRP radios are used to upconvert the simulated baseband signal (IF = 0) to RF. The selected frequency can be an arbitrary frequency defined by the user (for example for Jammers simulation) or a frequency defined by selected GNSS signals. The N310 radio is composed of 2 pairs of Tx channels.

The time offset between all Tx channels of the radio is <

1ns. We monitor and align the phase offset between RFs outputs of different radios during the simulation.

The Ettus USRP radios have been used in Skydel simulators for many years now and these radios perform very well in GNSS band. It uses 16-bit DAC to ensure 80dB of dynamic range. The Ettus N310 radio has high-end RF quality, and 4 RF outputs which makes it very convenient for bi-frequency simulation.

Distribution Module

An important part of the WF simulator is the distribution module (DM). It contains all the active and passive RF elements (switches, splitters, and combiners) needed to separate the main RF path from the calibration RF path. The DM is designed to strongly isolate high power (interference) from low power signals (GNSS signals) between each element output. This isolation is higher than 100 dB which is necessary to avoid signal leakage between all the outputs.

The DM is built with the option to add as much as four different carrier frequencies per simulated antenna's element. One DM can output up to 8 antenna elements, and 2 DM can be combined for a total of 16 elements.



Figure 4 - Ettus USRP N310

Calibration

The DM is the only part of the system that must be calibrated. The difference between the main RF path and the calibration path is static and can be compensated with static biases. These biases are unique for each distribution module. This calibration is done thanks to a calibration tool and an additional X300 radio which are a part of the deliverable WF system. This semi-autocalibration process can be performed either by Orolia or a trained customer. A 1-year calibration period is recommended.

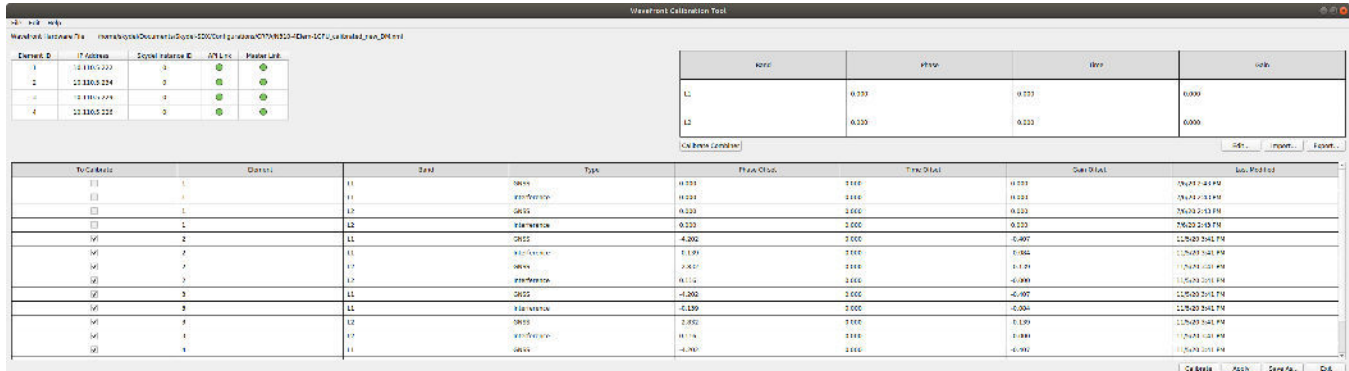

Figure 5 – Skydel Semi-Automatic Calibration Tool

Simulator Node

The Skydel simulation engine is designed to scale up (or down) to meet the specific user requirements. Using COTS hardware such as computer and graphics cards, the processing power can be elevated to unrivaled performance in the industry.

Each simulator node industrial computers with up to 2 high-end graphic cards to generate the GNSS and interference signals. Typically, this configuration is perfect to simulate all the main GNSS constellation signals, hundreds of jammers and 1 or 2 spoofers.

For very high-end requirements, the simulator node can be switched for a server computer with 2 CPUs and up to 8 GPUs, and can simulate over 1000 signals simultaneously per element. With this level of performance, it is possible to simulate multiple spoofers and repeaters with all the GNSS constellations and frequencies to stress the performance of the CRPA electronics to its limits.

The connection of the simulator node with the other equipment in the system is illustrated on the figure below.



Figure 6 – Simulator node

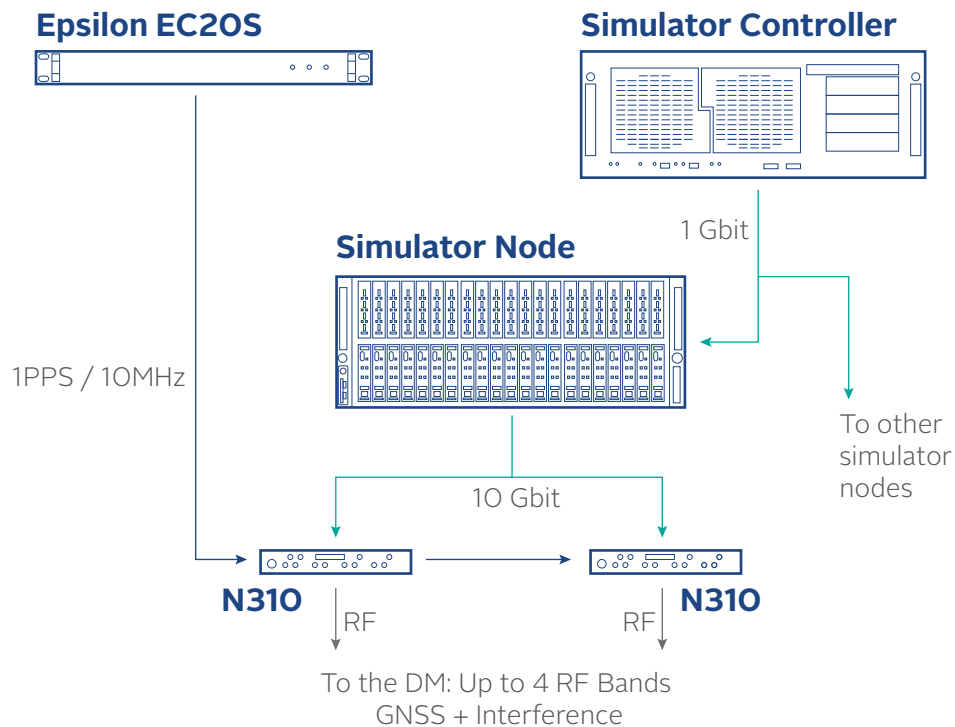

Soundproof rack

For the security and comfort of the engineers in the laboratory environment, the Skydel Wavefront simulator is delivered in a soundproof rack with high acoustic isolation (> 30 dB). The arrangement of the devices in the rack is thought for a simple and convenient daily use of the simulator, and all the decibels generated by the Skydel Wavefront simulator are captured inside the cabinet.

Temperature management is also optimized to have a uniform temperature in the rack and maintain it in an acceptable range.

Other options are possible on request (transportable rack, etc.).

3.3. Software

All the features and performance of the Skydel Simulation Engine are detailed in section 2 of the present document. This chapter describes some key features of the Skydel Wavefront simulator, especially designed for CRPA testing.

CRPA Antenna configuration

The first step is the configuration of the CRPA antenna. The maximum number of elements is defined by the hardware configuration and the XML configuration file in use. You can deactivate elements in the user interface if needed.

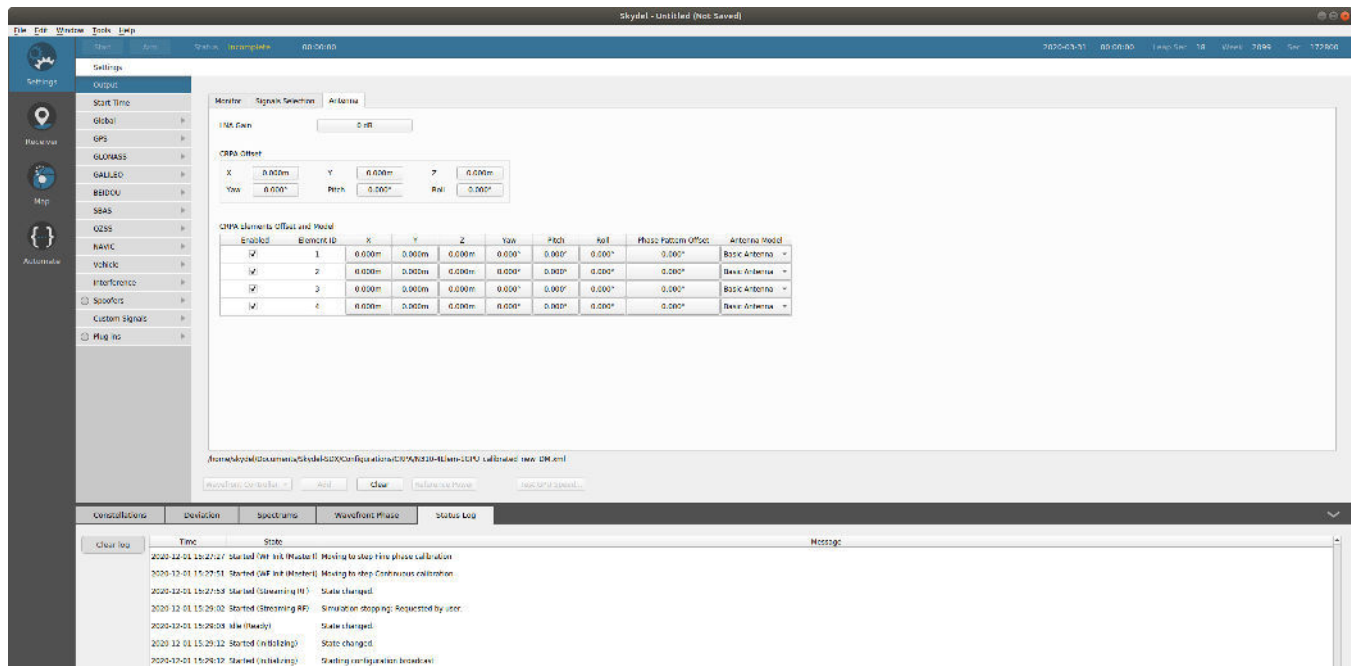

Figure 8 – CRPA Antenna configuration

The lever arm and attitude of the CRPA plate can be configured (CRPA Offset). Any reference point on the antenna can be chosen by the user.

All the antenna elements are positioned relatively to this reference point, in the geometric frame of the antenna. The antenna pattern (for each frequency) of each antenna element can be modified individually, and a fixed phase offset applied.

Directional jammer configuration

Transmitters can be added in a very simple way in the simulator. Skydel automatically calculates the propagation time for each element and adjusts the jammer phase delay consequently. Modern CRPA processing units can handle many jammers, which is supported by Skydel.

In Skydel, a transmitter is the physical device that will move around the simulated receiver, and with its own antenna pattern. Each transmitter can simulate a large number (hundreds) of signals, only limited by the size of the GPUs. The interference signals can be pre-defined waveforms (CW, AWGN, BPSK, etc.) or a custom IQ file. The process to add a jammer in the simulation is explained below:

Add a dynamic transmitter

Give a name and define the reference power

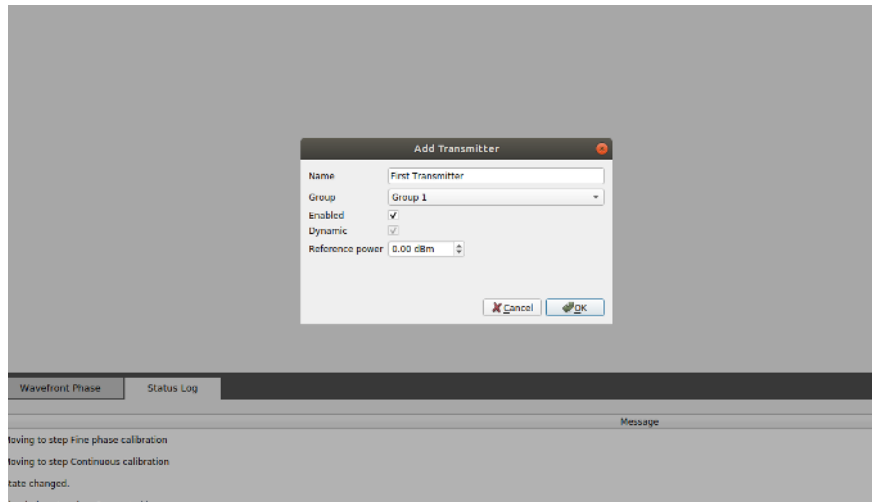

Define the trajectory of the transmitter

Can be fixed, circular, HIL (injected from remote) or a CSV file.

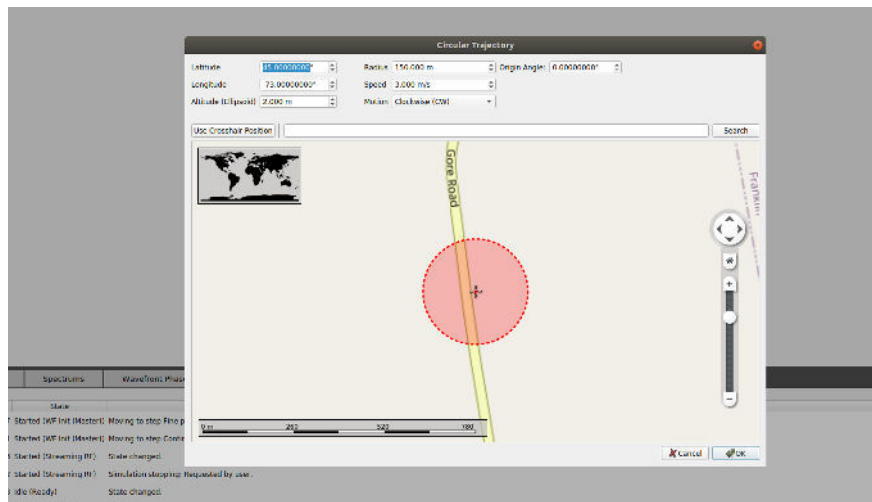

Define the power of the transmitter

Can be dynamically calculated (with antenna patterns and propagation loss) or fixed.

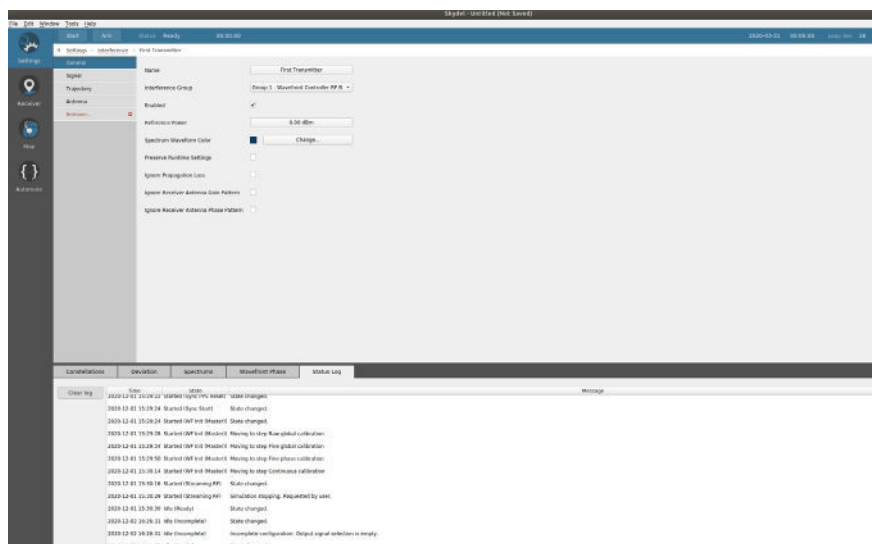

Add the waveforms to the transmitter

An unlimited number of waveforms can be added (in the limit of the GPU and the maximum power of the output)

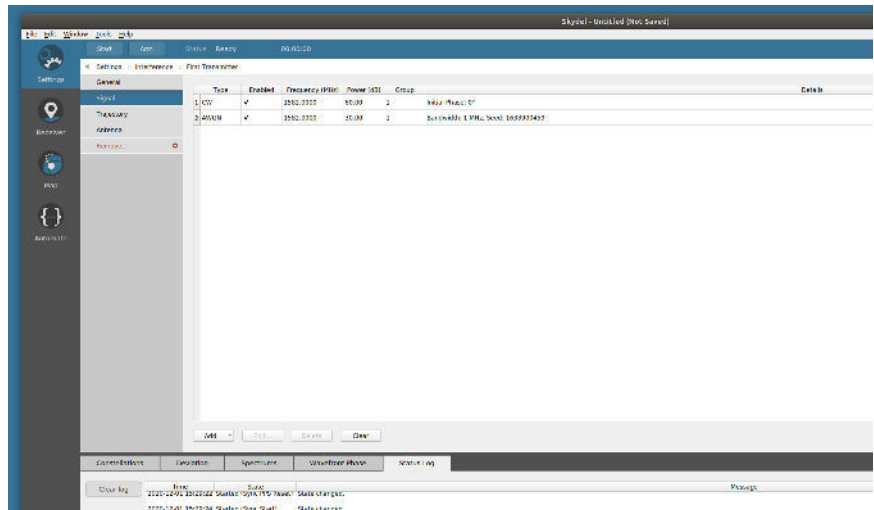

Figure 9 – Directional jammer configuration

Finally start the simulation, the resulting jamming spectrum is visible in the Spectrums window (each transmitter is represented with a different color). The position and power of the transmitter is visible on the Map window.

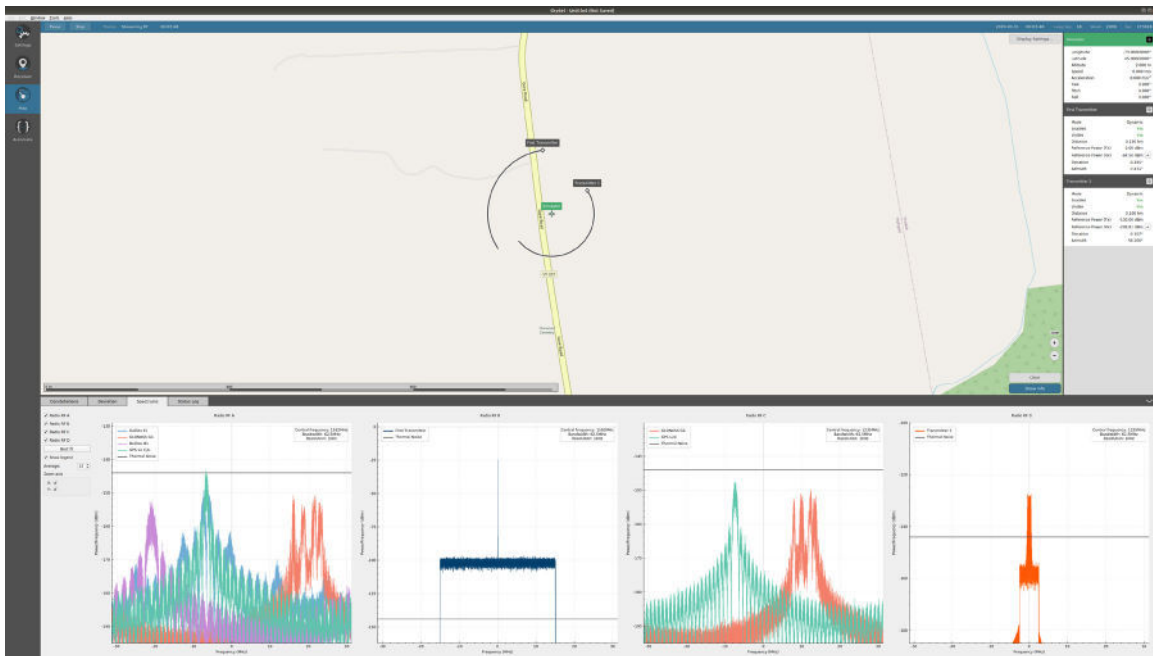

Figure 10 – Illustration of a jammer spectrum and trajectory

Directional spoofer configuration

Spoofers are a challenge for traditional CRPA GNSS simulators because each spoofer uses a lot of resources, with dedicated channel cards, and complicated hardware and software configuration. Indeed, each spoofer must simulate all the GNSS constellations for the spoofed position, with a different propagation delay for each antenna element.

In Skydel, the simulation of a spoofer is managed very simply and efficiently. Just like configuring a jammer, the physical location of the spoofing device is configured with the definition of a transmitter. The spoofing transmitter can be static or dynamic and simulates a new (or identical) GNSS constellation. The resulting signal is the signal from the spoofed location, plus the range from the transmitter to the simulated vehicle, as illustrated below:

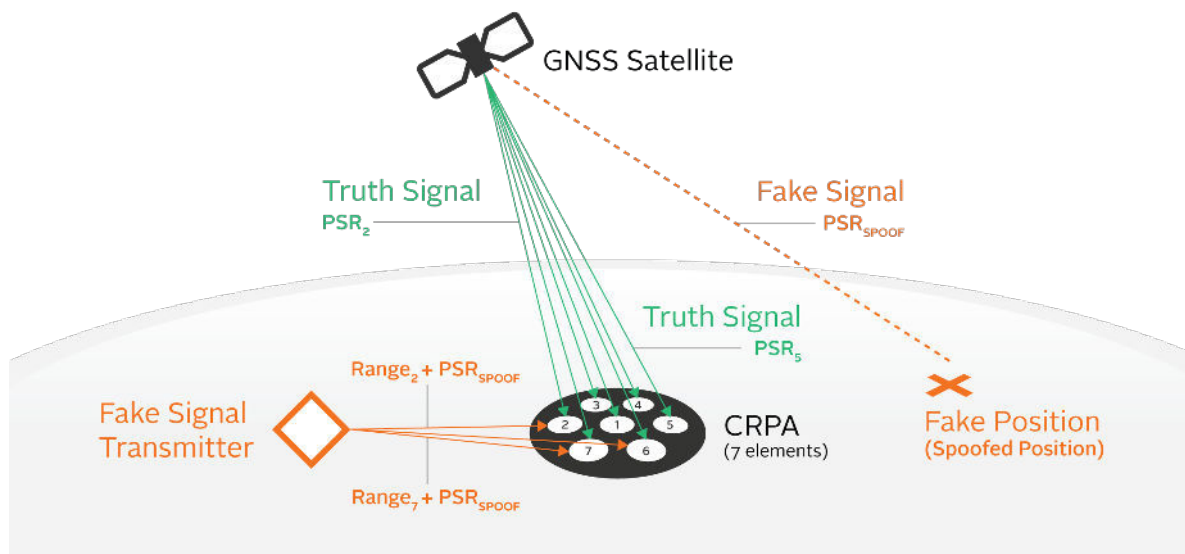
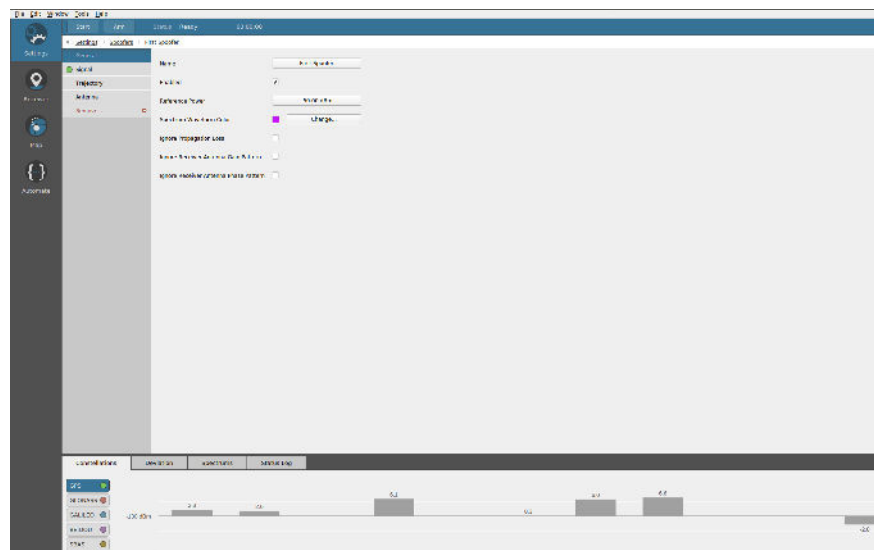

Figure 11 – Spoofing simulation principle in CRPA testing

The process to add a spoofer in the simulation is explained below:

Add a spoofing transmitter

Give a name and define the reference power. It can be dynamically calculated (with antenna patterns and propagation loss) or fixed.



Define the trajectory of the transmitter

Can be fixed, circular, HIL (injected from remote) or a CSV file.

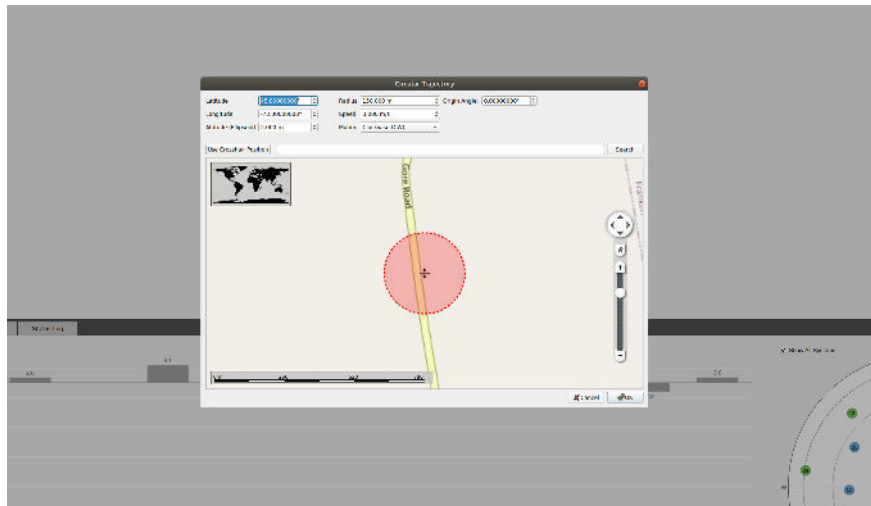

Define the spoofed simulation

In a spoofer instance of Skydel, create the scenario for the spoofed simulation. All the parameters of a normal Skydel scenario can be set (vehicle trajectory, GNSS constellations, impairments, etc.). Time or power ramps can be added too.

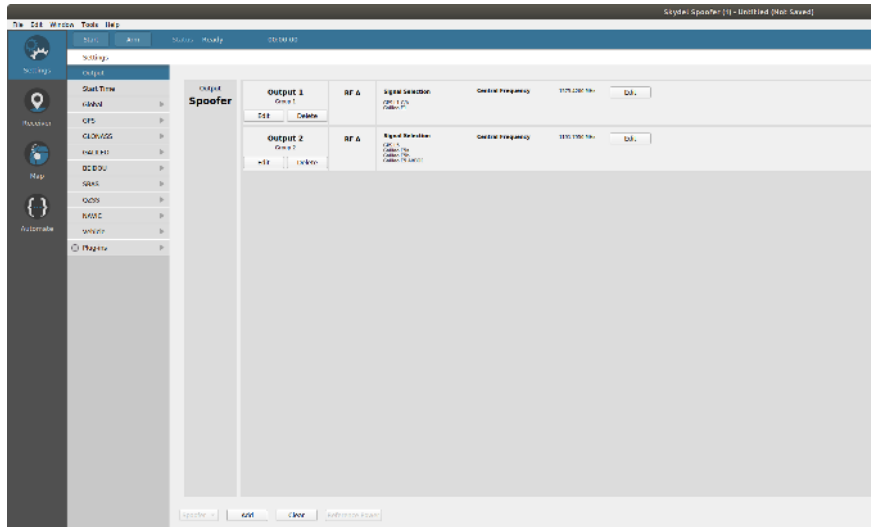

Connect to the spoofer

Set the IP address – usually 127.0.0.1 (local IP) - and instance Id of the spoofer to connect the main instance to the spoofer instance.

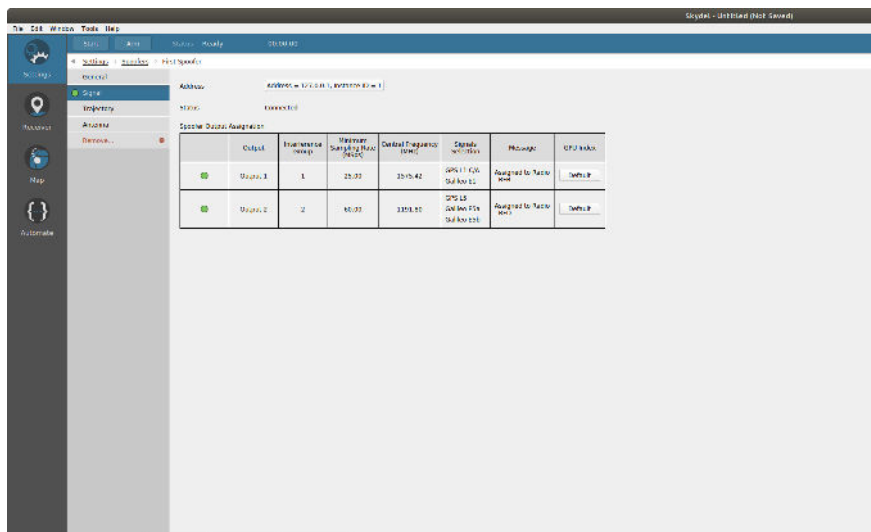

Figure 12 – Directional spoofer configuration

Connect to the spoofer

Set the IP address – usually 127.0.0.1 (local IP) - and instance Id of the spoofer to connect the main instance to the spoofer instance.

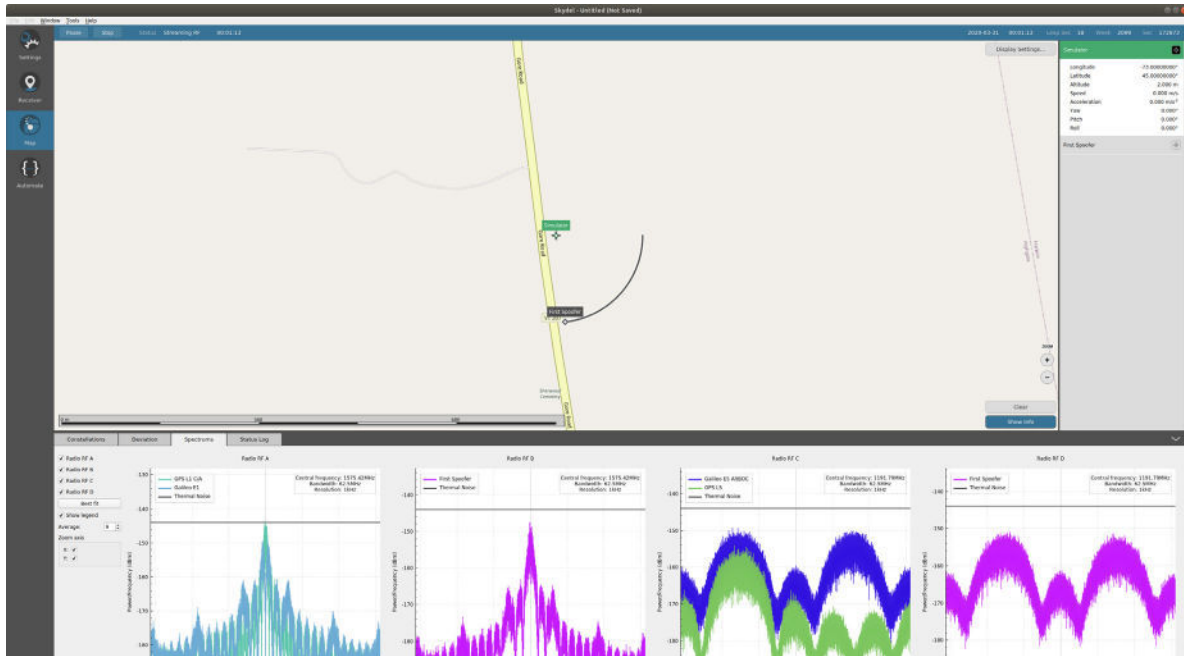

Figure 13 - Illustration of a spoofer spectrum and trajectory

4. Specification

Skydel Simulation Engine Key Features

- All-in-view satellites simulation
- 1000 Hz simulation iteration rate
- Low-latency HIL
- On-the-fly scenario reconfiguration
- 6 Degrees of Freedom (DoF) receiver trajectories
- Flexible licensing
- High-end performance (precision, resolution, ultra-high dynamic motion)
- Simulate hundreds of satellites in real time, using off-the-shelf graphics cards (GPU)
- Comprehensive and intuitive API (Python, C# and C++ open source client)
- IQ file generation and playback

Signal Propagation and Errors Simulation

- Multipath
- Additive pseudorange ramps
- Satellite clock error modification
- Navigation message errors
- Multiple ionospheric/tropospheric models
- Antenna pattern models
- Relativistic effects
- Pseudorange/ephemeris errors Signals
- GPS: L1-C/A, L1C, L1-P, L2-P, L2C, L5, M-Noise
- GPS: L1/L2-Y, L1/L2-AESM, L1/L2-MNSA*
- GLONASS: G1, G2
- Galileo: E1, E5a, E5b, E5AltBOC, PRS-Noise, HAS-Noise
- BeiDou-2: B1, B2
- BeiDou-3: B1C, B2a
- QZSS: L1-C/A, L5, L1C, L1S, L5S
- NAVIC: L5
- SBAS: WAAS, EGNOS, MSAS, GAGAN, SDCM
- Custom signals

Oscillator Performance (EC2OS Epsilon OCXO Clock)

- Medium Term Stability (without GPS): $< 2 \times 10^{-10}$ / day
- Temperature Stability: $< 1 \times 10^{-9}$ (from 0 to 60° C)

Vehicle Dynamics

- Max relative velocity: 1,500,000 m/s
- Max relative acceleration: No limits
- Maximum relative jerk: No limits
- Angular Rates $> 60\pi$ rad/s

Signal Specifications

- Pseudorange Accuracy - 0.3 mm RMS
- Deltarange Accuracy - ± 0.1 mm
- Inter-channel bias - zero
- GNSS Signals power: -175 dBm to -100 dBm
- Spurious transmission < -152 dBm
- Harmonics < -40 dBc
- Phase noise: < 0.003 rad RMS
- Absolute Power Accuracy: ± 0.5 dB
- Resolution: 0.1 dB

Antenna Elements

- 2 to 16 antenna elements
- Carrier Phase Alignment: < 1 -deg RMS
- Code Phase Alignment: ± 300 ps
- Power Alignment: ± 0.1 dB
- Power isolation: > 100 dB

Jamming & Spoofing Performance

- Jamming maximum power (single jammer):
 - CW, Swept, Pulsed, BPSK, BOC: 123 dB of J/S (S = -130 dBm)
 - AWGN: 113 dB of J/S (S = -130 dBm)
 - IQ File: Waveform dependent
- Jamming power range: > 130 dB
- Jammers number: > 100
- Spoofers number: 1 to 7+
- Spoofer GNSS Signals: Same as the truth signals
- Spoofer minimum power: < -150 dBm

* GPS encrypted signals available on certain Skydel Wavefront models



5. Available Models

There are two available options for purchasing a Skydel Wavefront simulator - Skydel GSG Wavefront and Skydel BroadSim Wavefront. See below to decide which option best suits you.

Skydel GSG Wavefront

- Includes all the features and benefits of Skydel
- Available through Orolia

Skydel BroadSim Wavefront

- Includes all the features and benefits of Skydel plus support for GPS encrypted signals
- Supports Y-Code, M-AES, and M-MNSA
- Available only through Orolia Defense & Security

www.oriolids.com
sales@oriolids.com