

GTEM CELLS

EMISSIONS AND IMMUNITY TESTING IN A SINGLE, SHIELDED ENVIRONMENT

FUNCTION

A **GTEM (Gigahertz Transverse Electro Magnetic)** cell is a test site for efficiently performing both radiated immunity and emissions testing in a single, controllable and shielded environment. Compared to other test sites, GTEM testing is faster with high accuracy and excellent reproducibility.

- Meets basic standard: IEC/EN 61000-4-20
- Meets standards for emissions testing: CISPR 14-1, IEC 61000-6-3 and IEC 61000-6-4 for EUTs without connected cables
- Meets standards for immunity testing: EN 60118-13
- Ideal for design qualification and pre-certification
- Fields generated are largely homogeneous and simple to calculate
- Efficient power conversion requires smaller power amplifier
- Excellent VSWR over the entire frequency range – no need for measurement of reflected power

GTEM stands for Gigahertz Transverse Electro Magnetic. This special type of cell has the advantage of having no cut-off frequency as do other types of TEM waveguides.

In principle, the GTEM cell is a coaxial line expanding pyramidally and having an impedance of 50Ω . At its end, the line is terminated by a combination of termination resistors and RF absorbers designed and constructed to match the above mentioned impedance.

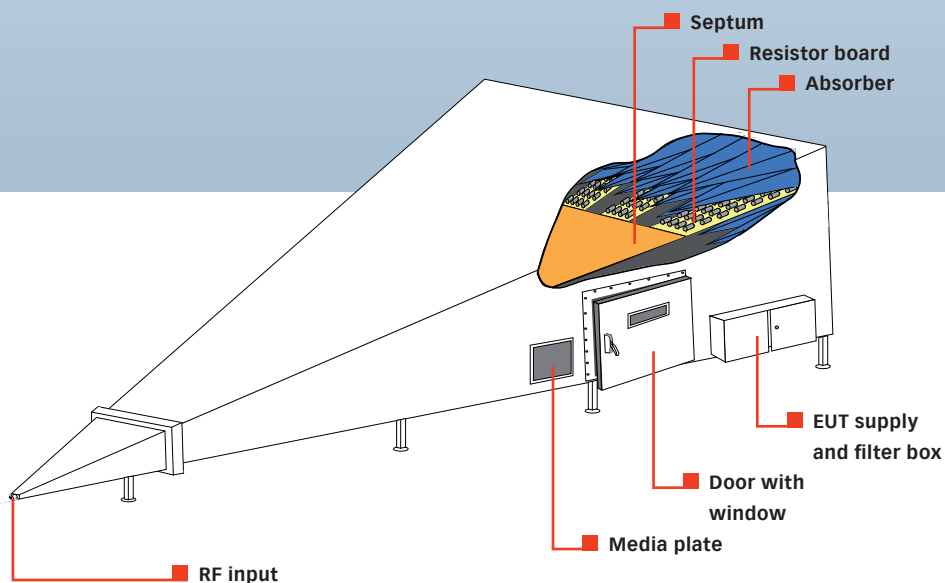



FIELD GENERATION

Electromagnetic fields can be generated by the connection of an RF generator and power amplifier to the feeding point of the GTEM. TEM waves start to propagate between the septum and outer conductor (cell body).

The electromagnetic field intensity is directly related to both the supplied input power and to the distance between septum and outer conductor.

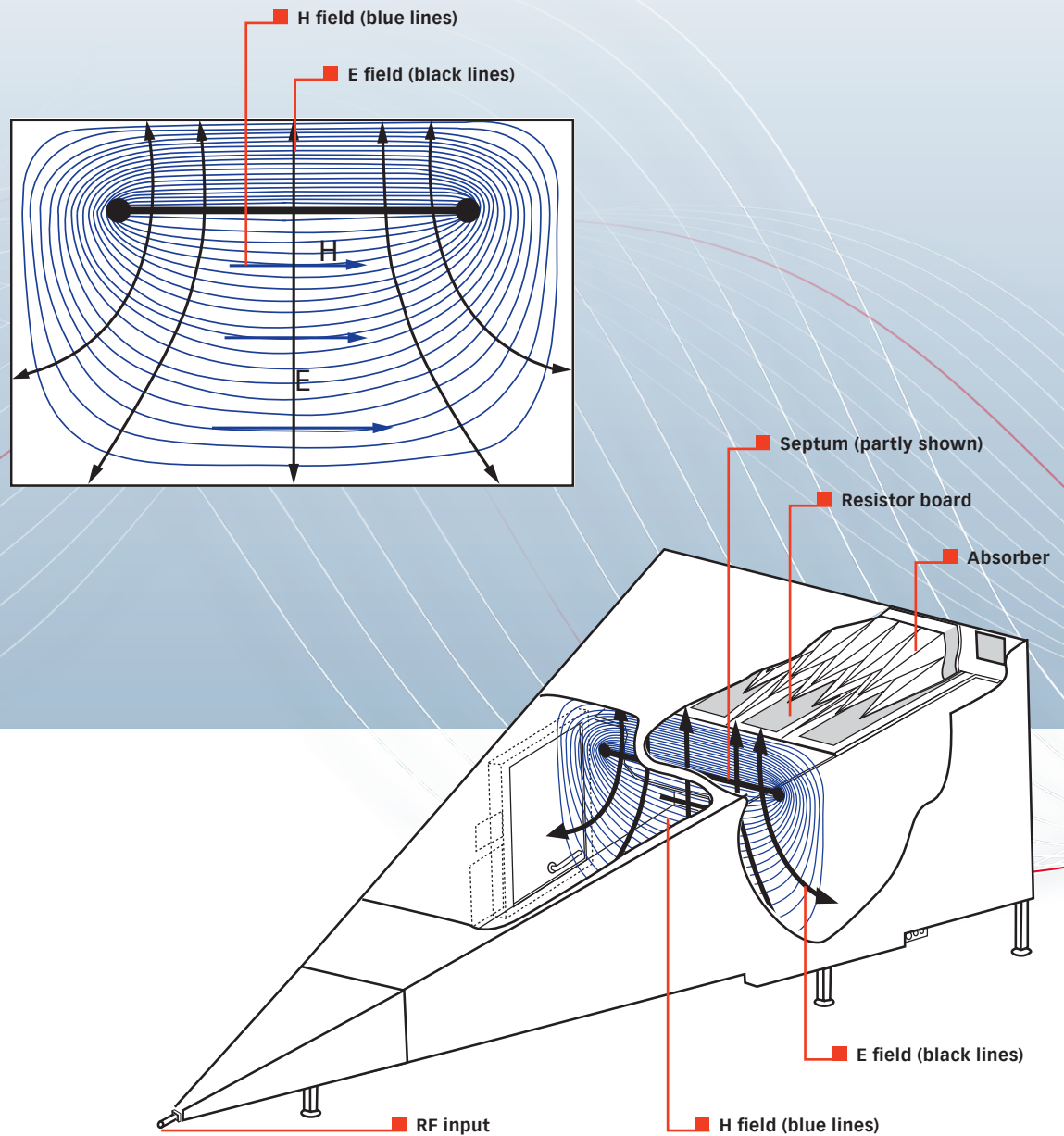



Calculation of required input power

- The field strength is typically independent from the frequency.
- The frequency range is from DC to 20 GHz. The best performance is achieved in the range 80 to 1000 MHz.
- FAR (Fully Anechoic Room) requires an amplifier with 100 W for 10 V/m. A GTEM 750 requires only 7.3 W.
- A decreased septum height provides higher field strength (applicable for small EUTs only).

Example of power requirement for 10 V/m at septum height 0.75 m

Field strength	E	= 10 V/m
Septum height	h	= 0.75 m
Input impedance	Z	= 50 Ω
Flatness	F	= 3 dB = 2
Modulation	M	= 3.24 (for AM 80% as required for IEC 61000-4-3)
	M	= 1 (for AM 80% as required for Automotive and MIL standards)

Power $P = (E \cdot h)^2 / Z \cdot F \cdot M$

Example $P = (10 \text{ V/m} \cdot 0.75 \text{ m})^2 / 50 \Omega \cdot 2 \cdot 3.24 = 7.3 \text{ W} = 38.6 \text{ dBm}$

Example of a generated field strength with 7.3 W input power at septum height 0.75 m

Field strength $E = \sqrt{(P / (M \cdot F) \cdot Z) / h}$

Example $E = \sqrt{(7.3 \text{ W} / (3.24 \cdot 2) \cdot 50 \Omega) / 0.75 \text{ m}} = 10 \text{ V/m}$

Example of required input power for 10 V/m in relation to the septum height

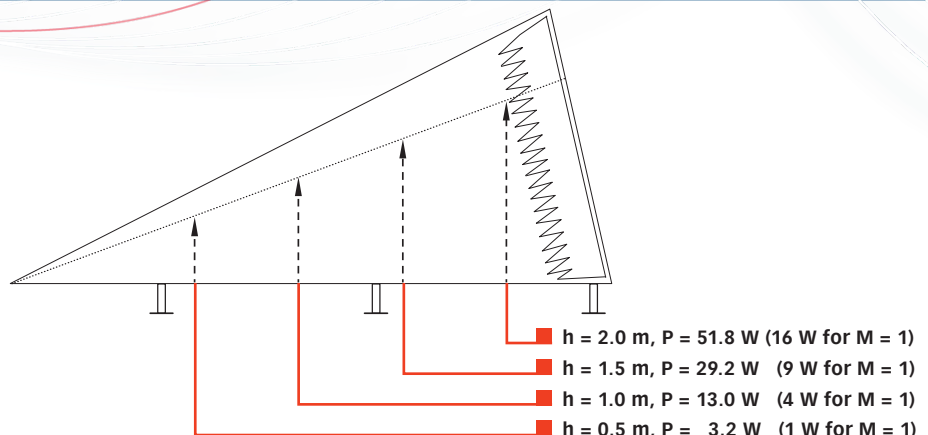



TEM MODE AND UNIFORM-AREA

IEC 61000-4-20 – Electromagnetic compatibility (EMC) – Part 4-20: Testing and measurement techniques – Emission and immunity testing in transverse electromagnetic (TEM) waveguides – is published as a basic standard which sets the requirements for performing EMC testing in waveguides. It describes the TEM mode verification as an elementary requirement for qualifying the waveguide. This procedure requires a field generating setup and an isotropic 3-axis field probe. The number and position of the points to be verified is related to the GTEM size as shown in the table below. The procedure verifies the TEM mode and also determines the size of the uniform area, maximum EUT size and the required power for a given field strength for immunity testing.

GTEM size, max. septum height	250	500	750	1000	1250	1500	1750	2000
Length d of one side of uniform area in mm	83	167	250	333	416	500	583	666
Septum height at marker position in mm (see also Figure on page 13)	217	433	650	866	1083	1299	1516	1732
Measuring points	1	5	5	5	5	9	9	9

GTEM cell, cross-section of the generated field and example of point positioning

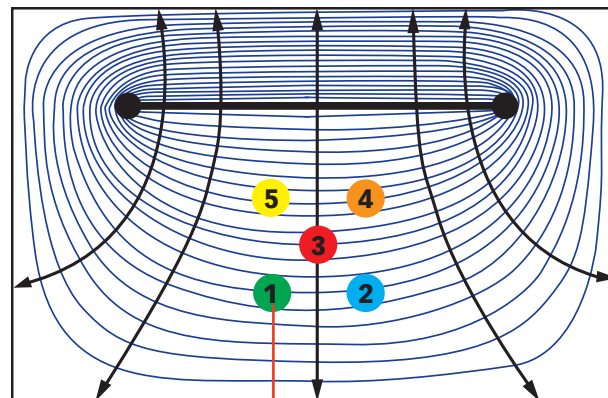

■ Calibration points (number in relation of the size of the area)

IMMUNITY TESTING

A typical setup for immunity testing consists of:

- Test House Software
- Signal generator
- Power amplifier
- Directional coupler
- Power meter
- GTEM
- Field probe (for calibration procedure only)

Example of setup 9 kHz to 1 GHz with one power amplifier

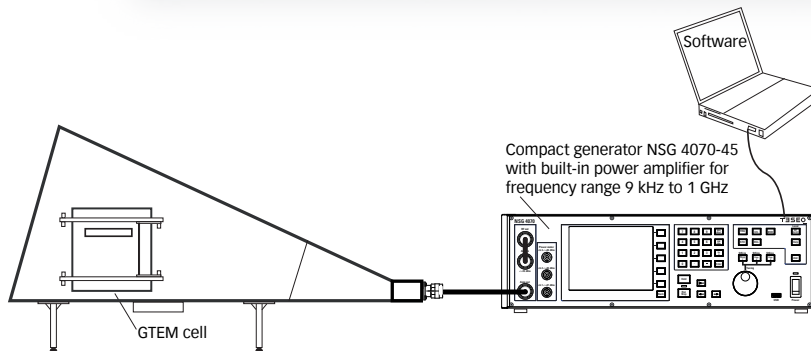

Example of setup 80 MHz to 3 GHz with two power amplifiers

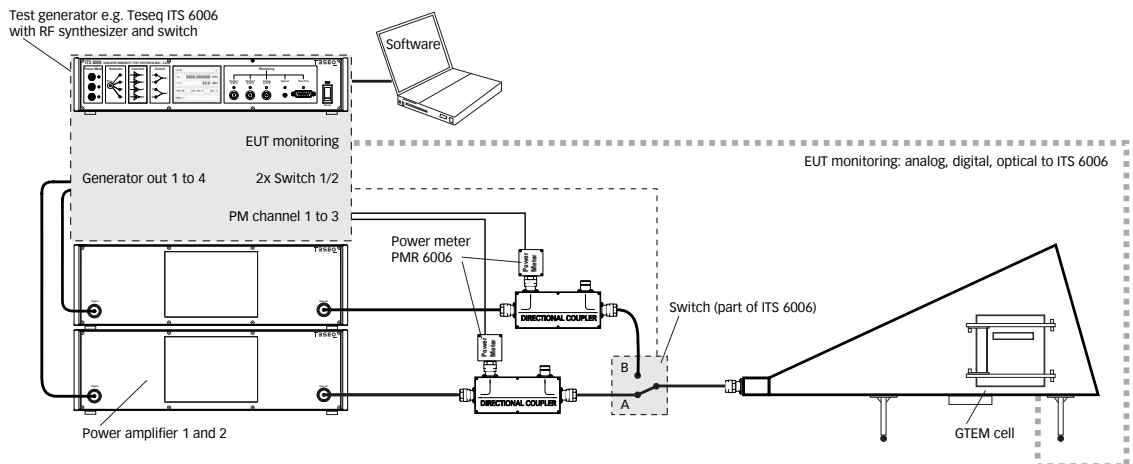

EMISSIONS MEASUREMENT

EUT radiated emissions are measured as a voltage at the feeding point of the GTEM. Measurements of at least three orthogonal EUT positions are required and the data is converted to a comparable field strength on an OATS (Open Area Test Site) by means of a GTEM correlation algorithm. Optional software offers this algorithm. Emissions measurements below 30 MHz as given in CISPR 25, RTCA DO 160C/D/E and MIL 461/462 can also be performed in a large GTEM cell. This alternative procedure is described in a Teseq application note.

Emissions measurement setup example

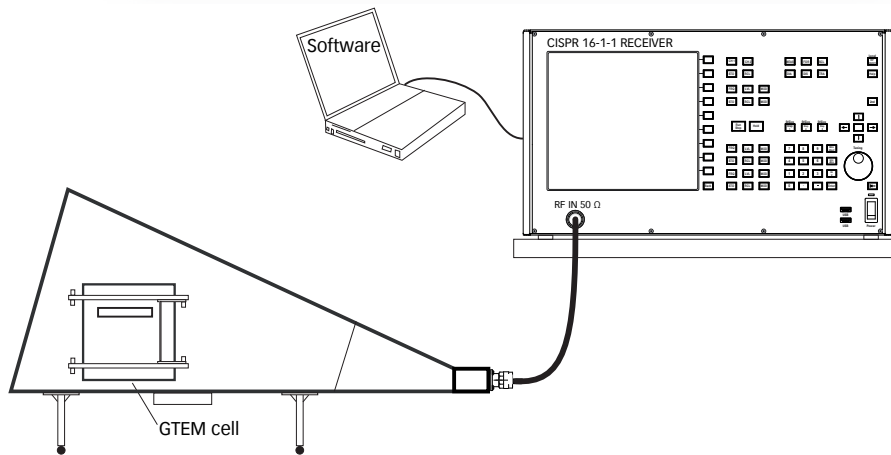



Simplified flow chart of the correlation procedure

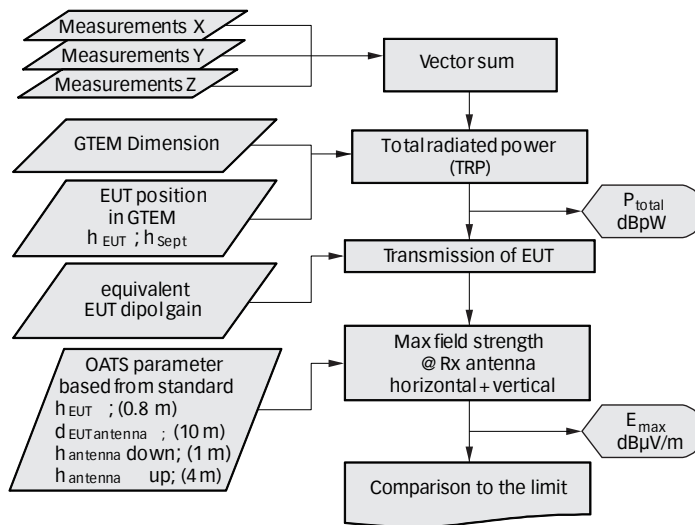

Comparison of Teseq VSQ 1000 reference source measured in four different test facilities:

- Semi-anechoic Chamber of the Federal Network Agency Germany, 10 m distance, maximum values in horizontal and vertical polarization
- Open Area Test Site Seibersdorf, Austria, 10 m distance, maximum values in horizontal and vertical polarization
- Open Area Test Site Capel, United Kingdom, 10 m distance, maximum values in horizontal and vertical polarization
- GTEM 1750, Teseq Berlin, Germany

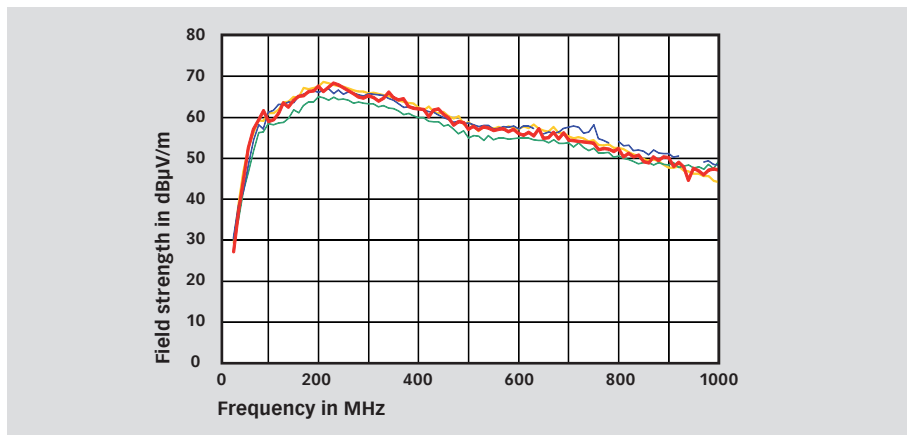

	Picture	Frequency range / frequency range according IEC/EN 61000-4-20	Immunity/emission testing	Max. septum height in mm	Max. RF input power inW	Input connector type N, 50 Ω	VSWR DC to 18 GHz	Dimension in m	Weight i kg/number of supports	Max. field strength in V/m with modulation (IEC 61000-4-3)	Max. field strength in V/m with modulation (Automotive, MIL)
GTEM 250, GTEM 250 SAE		DC to 20 GHz/ 30 MHz to 1000 MHz	■	250	50 (100)*	■	<1.45:1	L: 1.25 W: 0.65 H: 0.45	45 / 3	91 (128)*	163 (230)*
GTEM 250A SAE		DC to 20 GHz/ 30 MHz to 1000 MHz	■	250	100	■	<1.25:1	L: 1.25 W: 0.65 H: 0.45	45 / 3	128	230
GTEM 500		DC to 20 GHz/ 30 MHz to 1000 MHz	■	500	100 (400)*	■	<1.45:1	L: 2.95 W: 1.48 H: 1.61	242 / 3	64 (128)*	115 (230)*
GTEM 750		DC to 20 GHz/ 30 MHz to 1000 MHz	■	750	200 (500)*	■	<1.45:1	L: 3.95 W: 2.02 H: 1.95	390 / 6	60 (96)*	109 (172)*
GTEM 1000		DC to 20 GHz/ 30 MHz to 1000 MHz	■	1000	1000	■	<1.45:1	L: 4.95 W: 2.54 H: 2.30	790 / 8	101	183
GTEM 1250		DC to 20 GHz/ 30 MHz to 1000 MHz	■	1250	1000	■	<1.45:1	L: 5.95 W: 3.06 H: 2.52	1150 / 16	81	146
GTEM 1500		DC to 20 GHz/ 30 MHz to 1000 MHz	■	1500	1000	■	<1.6:1 (typ. <1.45:1)	L: 6.95 W: 3.58 H: 2.55	1470 / 25	68	122
GTEM 1750		DC to 20 GHz/ 30 MHz to 1000 MHz	■	1750	1000	■	<1.8:1 (typ. <1.45:1)	L: 7.95 W: 4.10 H: 2.90	1800 / 28	58	104
GTEM 2000		DC to 20 GHz/ 30 MHz to 1000 MHz	■	2000	1000	■	<1.8:1 (typ. <1.45:1)	L: 8.95 W: 4.62 H: 3.24	2500 / 34	51	91

■ standard

*) option

□ on request, see also next page

- not applicable

	Max. EUT size in m	Def. 0 to 6 dB EUT size in m	Door size in m	Door switch	Shielded window size in m	Number of fans	Shielding effectiveness (30 MHz to 3 GHz)	2 AC filter 16 A, 1 AC socket, line safety switch, earth leakage circuit breaker	Switchable illumination	Feed through panel with 3x N and optical feed through tube	Optional filter solutions for AC, DC and data	Type of optional XYZ Manipulator
GTEM 250, GTEM 250 SAE	L: 0.20 W: 0.20 H: 0.15	L: 0.083 W: 0.083 H: 0.083	L: 0.20 H: 0.13	-	optional L: 0.12 H: 0.07	1	>60 dB, typ. >80 dB	-	-	-	□	-
GTEM 250A SAE	L: 0.20 W: 0.20 H: 0.15	L: 0.083 W: 0.083 H: 0.083	L: 0.20 H: 0.13	-	optional L: 0.12 H: 0.07	1	90 dB	-	-	-	□	-
GTEM 500	L: 0.41 W: 0.41 H: 0.31	L: 0.167 W: 0.167 H: 0.167	L: 0.44 H: 0.38	■	L: 0.3 H: 0.1	(2)*	>60 dB, typ. >80 dB	■	■	■	□	MPH 500
GTEM 750	L: 0.62 W: 0.62 H: 0.49	L: 0.25 W: 0.25 H: 0.25	L: 0.65 H: 0.50	■	L: 0.3 H: 0.1	(2)*	>60 dB, typ. >80 dB	■	■	■	□	MPH 600A, MPC 600A
GTEM 1000	L: 0.74 W: 0.74 H: 0.66	L: 0.333 W: 0.333 H: 0.333	L: 0.48 H: 0.68	■	L: 0.3 H: 0.1	5	>60 dB, typ. >80 dB	■	■	■	□	MPH 1000, MPC 1000
GTEM 1250	L: 0.93 W: 0.93 H: 0.83	L: 0.416 W: 0.416 H: 0.416	L: 0.85 H: 0.85	■	L: 0.3 H: 0.1	5	>60 dB, typ. >80 dB	■	■	■	□	MPH 1250A, MPC 1250A
GTEM 1500	L: 1.11 W: 1.11 H: 0.99	L: 0.5 W: 0.5 H: 0.5	L: 0.99 H: 1.29	■	L: 0.3 H: 0.1	5	>60 dB, typ. >80 dB	■	■	■	□	MPH 1500A, MPC 1500A
GTEM 1750	L: 1.32 W: 1.32 H: 1.16	L: 0.583 W: 0.583 H: 0.583	L: 1.03 H: 1.54	■	L: 0.3 H: 0.1	5	>60 dB, typ. >80 dB	■	■	■	□	MPH 1750A, MPC 1750A
GTEM 2000	L: 1.50 W: 1.50 H: 1.32	L: 0.666 W: 0.666 H: 0.666	L: 1.03 H: 1.54	■	L: 0.3 H: 0.1	6	>60 dB, typ. >80 dB	■	■	■	□	-

■ standard

*) option

□ on request, see also next page

- not applicable

	Option for GTEM 250	Option for GTEM 500, GTEM 750	Option for GTEM 1000-2000	2 AC filter 16 A, 1 AC socket, line safety switch, earth leakage circuit breaker	4 AC filter 32 A, 1 AC socket 3 phase, line safety switch, earth leakage circuit breaker	Number of AC filters 63 A, 250 VAC 6/4 mm banana sockets	Number of DC filters 10 A, 130 VDC banana sockets	Number of AC filters 16 A, 250 V, banana sockets	Number of filters 15 A, 200 VDC, banana sockets	Number of AC filters 6 A, 250 V, IEC C14 and banana sockets	Number of filters 5 A, 200 VDC/ Sub-D connector type	Special filter	Optical feed through	Integrated in EUT BOX-1/-3/-31	Placed on Media S	Placed on Media 3	Placed on Media 4	Additional 2 sockets inside and 2 sockets outside, emergency switch, pilot lamps
SIA 250	■			-	-	-	-	-	10	-	4 / 9 pins	-	-	-	-	-	-	-
SIB 250	■			-	-	-	-	-	2	-	37 / 37 pins	-	-	-	-	-	-	-
SIC 250	■			-	-	-	-	-	6	2	9 / 9 pins	-	-	-	-	-	-	-
SID 250	■			-	-	-	-	-	2	2	15 / 15 pins	-	-	-	-	-	-	-
EUT BOX-250, EUT BOX-251	■			-	-	-	-	4	-	-	-	-	-	-	-	-	-	-
OPL 250	■			-	-	-	-	-	-	-	-	-	■	-	-	-	-	-
EUT BOX-1	-	-	■	■	-	-	-	-	-	-	-	-	-	-	-	-	-	-
DC 1	-	■	■	-	-	-	2	-	-	-	-	-	-	■	-	-	-	-
EUT BOX-3	-	-	■	-	■	-	-	-	-	-	-	-	-	-	-	-	-	-
EUT BOX-31	-	■	■	-	■	-	-	-	-	-	-	-	-	-	-	-	-	-
EUT BOX-4	-	■	■	-	-	-	4	-	-	-	-	-	-	-	-	-	-	-
EUT BOX-5	-	-	■	-	-	2	-	-	-	-	-	-	-	-	-	-	■	-
EUT BOX-6	-	-	■	-	-	10	-	-	-	-	-	-	-	-	-	■	-	-
EUT MG-1	-	-	■	■	-	-	-	-	-	-	-	-	-	-	-	-	■	■
EUT MG-3	-	-	■	-	■	-	-	-	-	-	-	-	-	-	-	-	■	■
SIF	-	■	■	-	-	-	-	-	-	-	25 / 25 pins	-	-	-	■	□	□	-
RS232 Filter	-	■	■	-	-	-	-	-	-	-	9 / 9 pins	-	-	-	■	□	□	-
ITE Filter	-	■	■	-	-	-	-	-	-	-	-	■	-	-	■	□	□	-
USB Filter	-	■	■	-	-	-	-	-	-	-	-	■	-	-	■	□	□	-
CAN BUS Filter	-	■	■	-	-	-	-	-	-	-	-	■	-	-	■	□	□	-

■ applicable □ on request - not applicable



XYZ MANIPULATOR



XYZ Manipulators are ideal for easily rotating the EUT into the three required orthogonal axis positions. The manual versions (MPH) are installed inside the cell while the remote controlled versions (MPC) have a motor underneath the floor of the cell. GTEMs can be supplied with removable panels to allow the future installation of XYZ Manipulators. The MPC requires factory installation. See also the XYZ Manipulator datasheet for more details.

XYZ Manipulator, example MPH 600A,

example MPH 1000

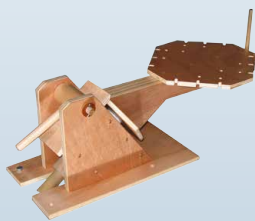

Position of XYZ Manipulator inside the GTEM cell

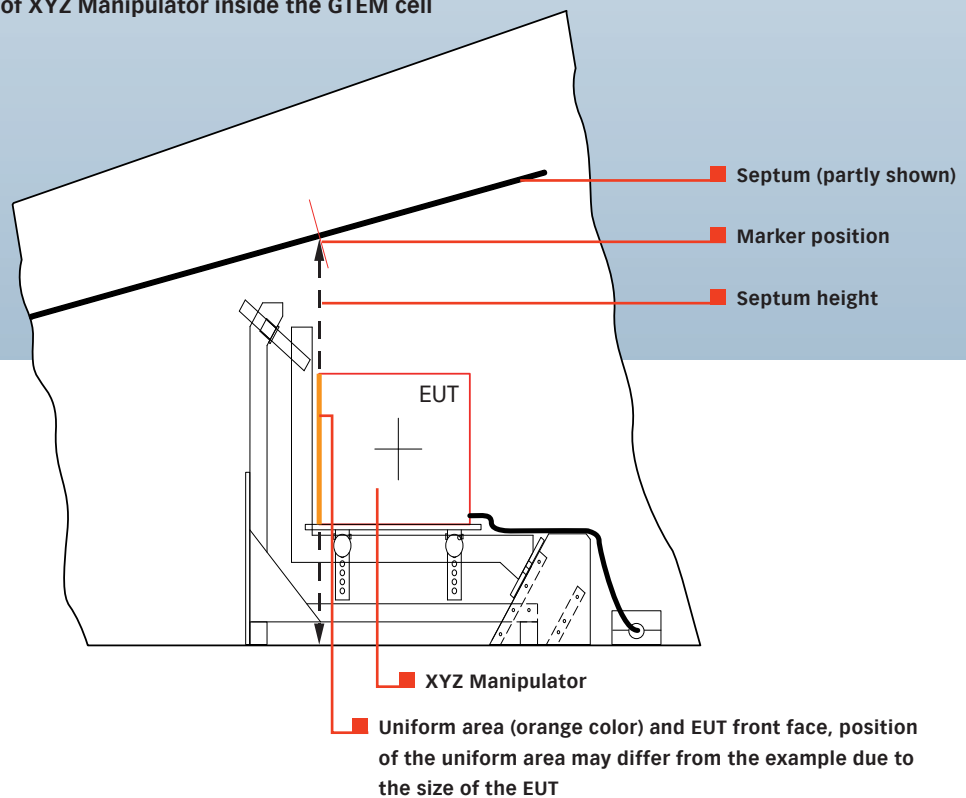



INTEGRATED CIRCUIT (IC) TESTING





Emissions measurements

The standards SAE J1752/3 and IEC 61967-2 define a method for measuring the electromagnetic radiation from an IC (integrated circuit) in the frequency range 150 kHz to 1 GHz. The IC itself is mounted on a shielded test board that is clamped to a special hole in the top of the TEM cell. Except for the IC, all the interface wiring and other required components are placed on the outside of the test board which becomes part of the cell wall. A spectrum analyzer or measurement receiver is connected to the GTEM and measures the RF emissions from the integrated circuit.

Immunity testing

The test board described above can also be used for IC immunity testing with a GTEM cell. The standard IEC 62132-2 specifies the immunity test method for integrated circuits in the frequency range 150 kHz to 1 GHz.

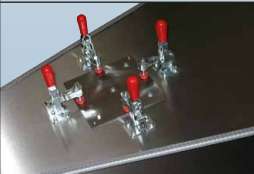
Product range for IC testing

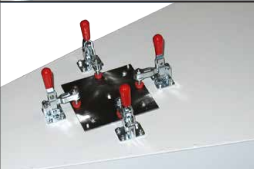
GTEM type	Picture	Description
GTEM 250-SAE		GTEM 250-SAE, 50 W RF input power, special opening for IC testing with approx. 45 mm septum height, meets SAE 1752/3, IEC 62132-2 and IEC 61967-2
GTEM 250A-SAE		GTEM 250A-SAE, 100 W RF input power, low VSWR, special opening for IC testing with approx. 45 mm septum height, meets SAE 1752/3, IEC 62132-2 and IEC 61967-2
GTEM 500 to GTEM 2000		Option for GTEM 500 to GTEM 2000, special opening for IC testing with approx. 45 mm septum height, meets SAE 1752/3, IEC 62132-2 and IEC 61967-2

GTEM 250
GTEM 250-SAE
GTEM 250A-SAE



GTEM 500

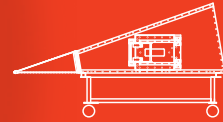

GTEM 750

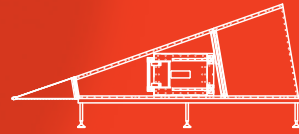

GTEM 1000

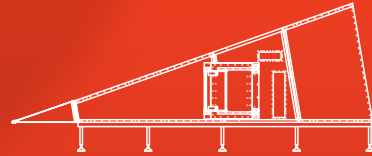

GTEM 1250

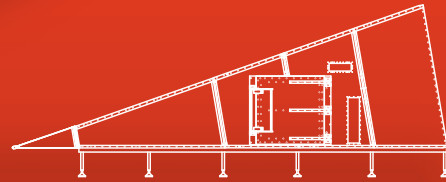

GTEM 1500

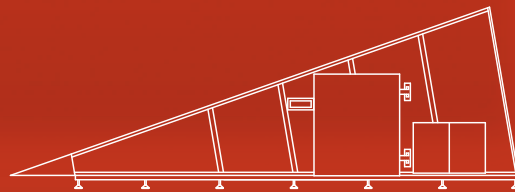

GTEM 1750

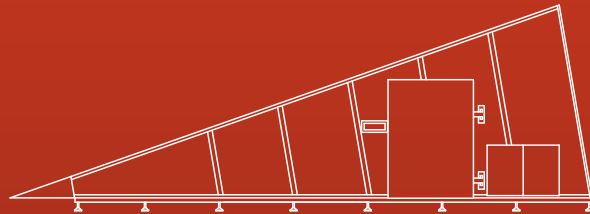

GTEM 2000

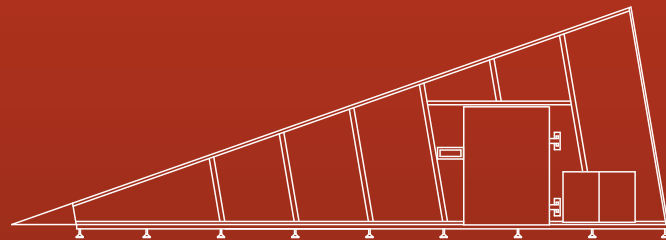

ON-SITE CALIBRATION



ON-SITE TRAINING



FACTORY TRAINING





EMC INSTRUMENTATION AND SYSTEMS FOR ANY BUDGET

Teseq® offers the world's most comprehensive range of EMC systems for immunity and emissions testing. We take great pride in our world-class research and development program, backed by state-of-the-art global manufacturing. Our membership in the relevant international committees demonstrates our commitment to the industry. Our network of direct sales offices, representatives and distributors offers market leading EMC expertise tailored to local needs in more than 30 different countries.

Our unique "modular" approach to EMC is focused on our customers' business needs. By breaking down the barriers between traditionally separate test functions we can optimize the test process to help you bring products to market more quickly.

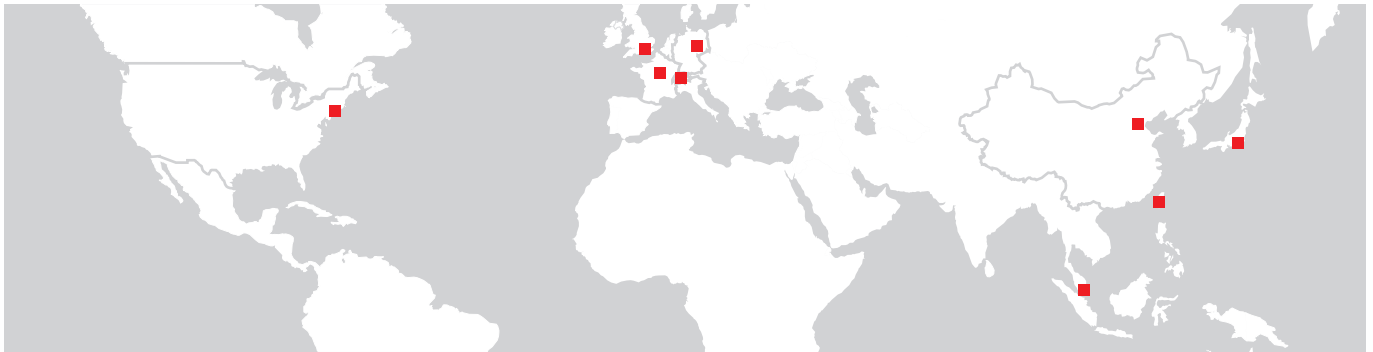

China

AMETEK Commercial Enterprise (Shanghai) Co., Ltd. Beijing Branch
T +8610 8526 2111
F +8610 8526 2141
chinasales@teseq.com

France

AMETEK SAS
T +33 1 30 68 89 00
F +33 1 30 68 89 99
info.france@ametek.com

Germany

Teseq GmbH
T +49 30 5659 8835
F +49 30 5659 8834
deinfo.teseq@ametek.com

Japan

AMETEK CO., Ltd. Nagoya Office
T +81 52 709 5501
F +81 52 709 5502
cts-japan.sales@ametek.co.jp

Singapore

AMETEK Singapore Pte Ltd (C/o Teseq Pte Ltd)
T +65 6484 2388
F +65 6481 6588
singaporesales@teseq.com

Switzerland

Teseq AG
T +41 32 681 40 50
F +41 32 681 40 48
chsales.teseq@ametek.com

Taiwan

Teseq (Taiwan) Ltd.
T +886 2 2917 8080
F +886 2 2917 2626
taiwansales@teseq.com

UK

Teseq Ltd.
T +44 845 074 0660
F +44 845 074 0656
uksales@teseq.com

USA

Teseq Inc.
T +1 732 417 0501
F +1 732 417 0511
Toll free +1 888 417 0501
usasales.cts@ametek.com

To find your local partner within Teseq's global network, please go to www.teseq.com

Teseq® is an ISO-registered company. Its products are designed and manufactured under the strict quality and environmental requirements of the ISO 9001.

81-250000 E03 November 2016
© 2016 Teseq®
Specifications subject to change without notice.

This document has been carefully checked. However, Teseq® does not assume any liability for errors, inaccuracies or changes due to technical developments.