



# CBL 6112D BILOG® ANTENNA 30 MHz to 2 GHz



CBL 6112D vertical onto tripod  
BTP 6020A

- Ideal for compliance emission testing
- VHF radio approval applications
- Immunity testing to 300W CW
- Excellent balance < 1dB
- No rotational offsets
- Easily transportable

### Three Antennas In One

The CBL 6112D operates over the unprecedented, wide range 30 MHz to 2 GHz. It effectively combines the performance of three standard EMC antennas, the Biconical, the Log Periodic and the Waveguide Horn. Considerable savings in the order of 40 - 50% can be made in expensive test time, plus the added benefit of improved repeatability and reliability by not having to laboriously disconnect and reconnect antennas during testing.

### Optimized for Emission Measurements

The CBL 6112D is primarily an emission measuring antenna but can handle CW powers up to 300 watts, making it suitable for most immunity measurements requiring fields up to 10 V/m, or even greater. The CBL 6112D is linearly polarized and exhibits excellent balance.

### Technical specifications

Frequency range:	30 MHz to 2 GHz
Typical gain:	6 dB (200 MHz to 700 MHz), 8 dB (700 MHz to 2000 MHz)
Impedance (nominal):	50 Ω
Maximum continuous power:	300 W (80 - 2000 MHz)
Connector:	N type female
VSWR:	Average 2:1
Size antenna (L x H x W in mm):	approx. 1530 X 1390 X 630 (see drawing)
Weight:	approx. 4.2 kg
Recommended tripod:	BTP 6020A

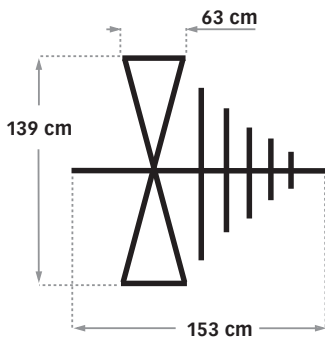

### Typical E field polar patterns for - - 30 MHz, .....1000 MHz and — 2000 MHz

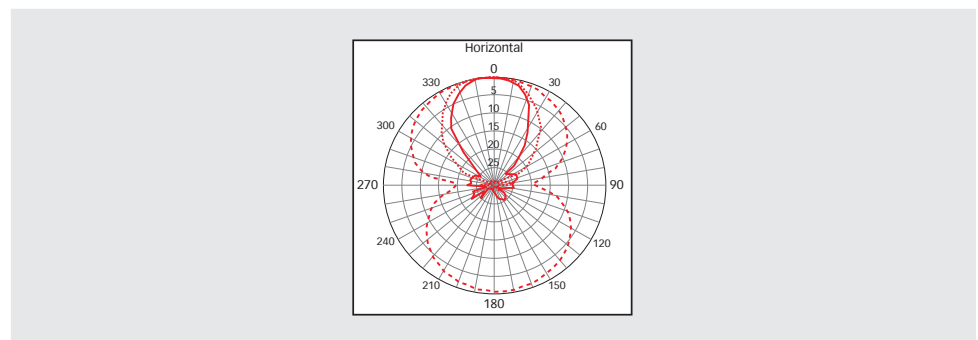

Advanced Test Solutions for EMC

# CBL 6112D BILOG<sup>®</sup> ANTENNA 30 MHz to 2 GHz

Typical VSWR

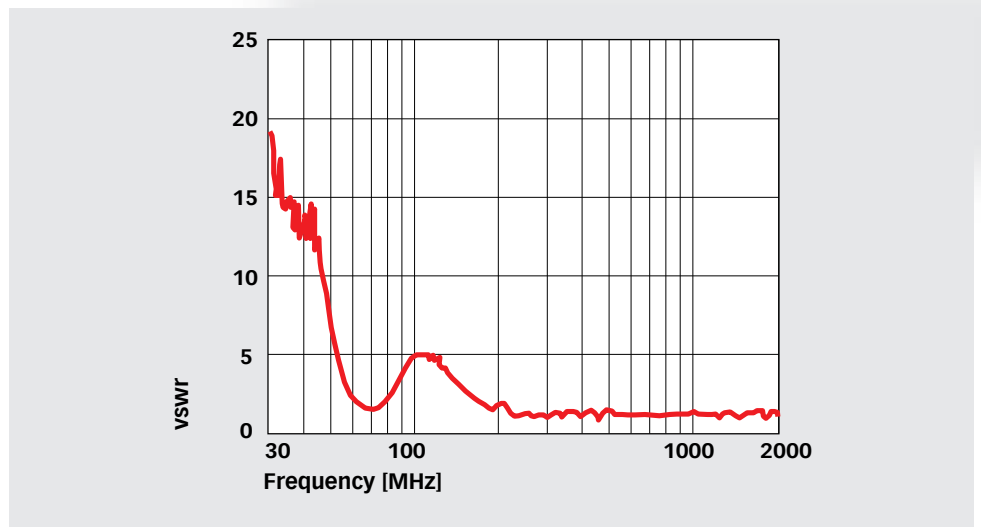

Typical drive power for 10 V/m at 3 m, - - - CW power, — power with 80% modulation

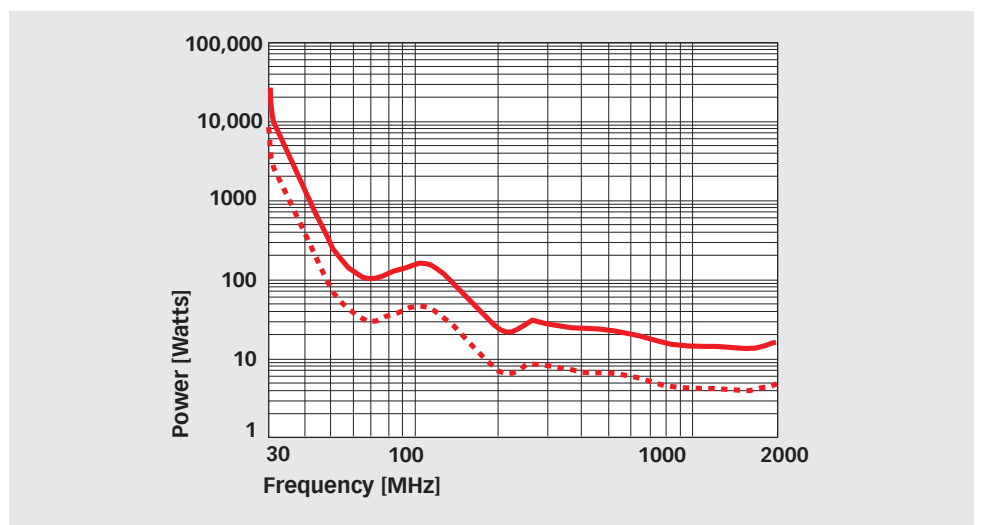



# **CBL 6112D** **BILOG® ANTENNA 30 MHz to 2 GHz**



Typical antenna factor

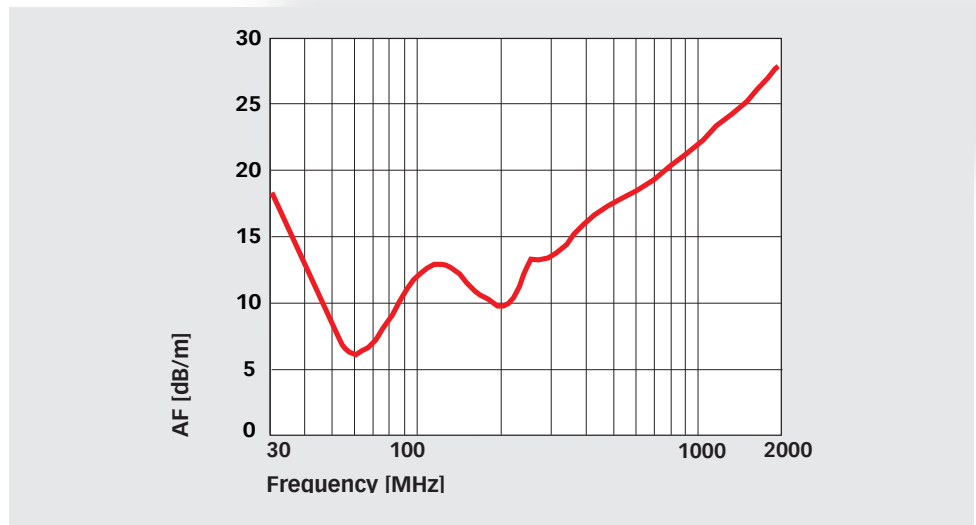

Typical gain

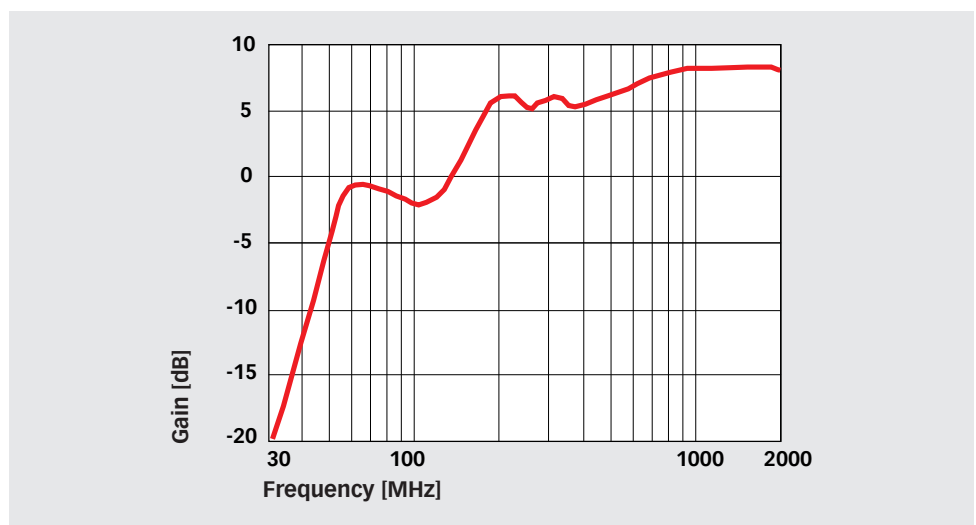

# **CBL 6112D** **BILOG® ANTENNA 30 MHz to 2 GHz**

Typical gain ratio

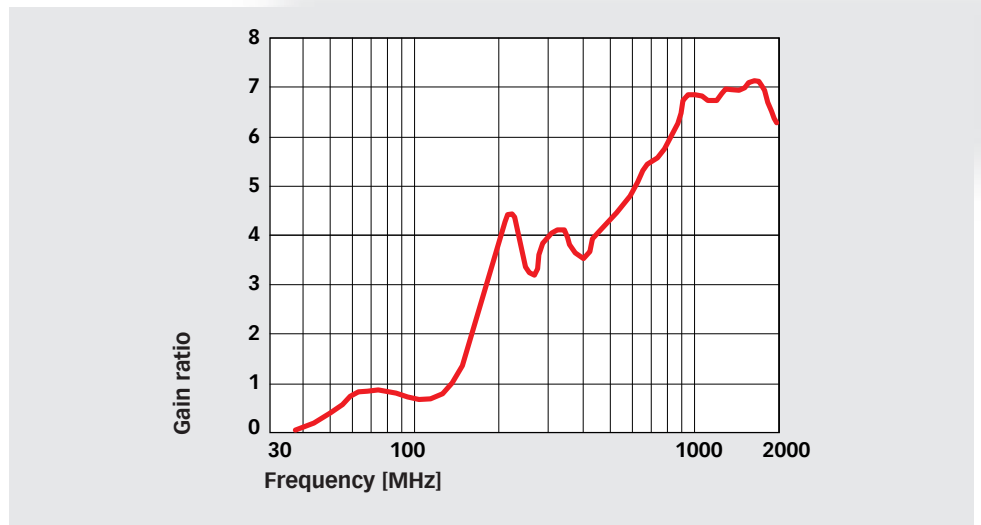

Typical cross polarisation

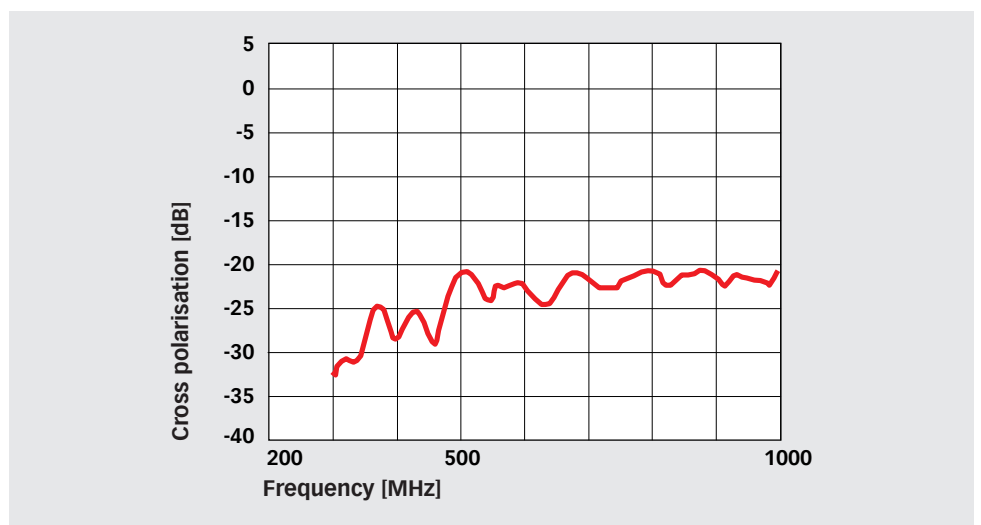



# CBL 6112D BILOG® ANTENNA 30 MHz to 2 GHz



CBL 6112D horizontal onto tripod  
BTP 6020A

### Typical balance

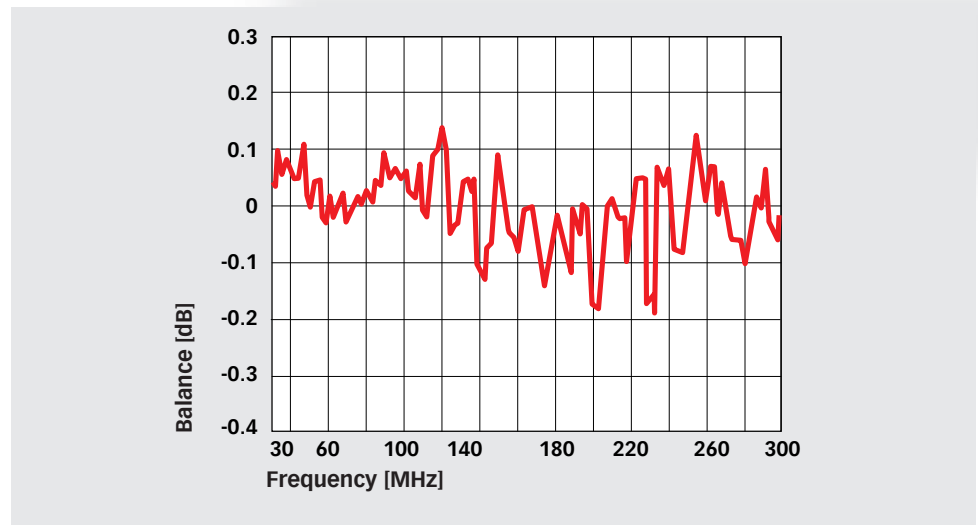

### Delivery information

Part number	Description
346-100	CBL 6112D BiLog antenna 30 MHz - 2 GHz
97-244570	Ant Cert-TC Traceable calibration (ISO17025), order only with the antenna, free space calibration (horizontal), other calibrations on request
248504	BTP 6020A-0880 EMC Tripod with tube 880 mm and mounting head for antennas with 22 mm tube
248505	BTP 6020A-0680 EMC Tripod with tube 680 mm and mounting head for antennas with 22 mm tube
248523	BTP 6020A-1370 EMC Tripod with tube 1370 mm and mounting head for antennas with 22 mm tube
346-199	MTC 9011 Metal transit case for CBL 6111, 6112, 6141 or 6143