

User Manual
SMA CLUSTER CONTROLLER

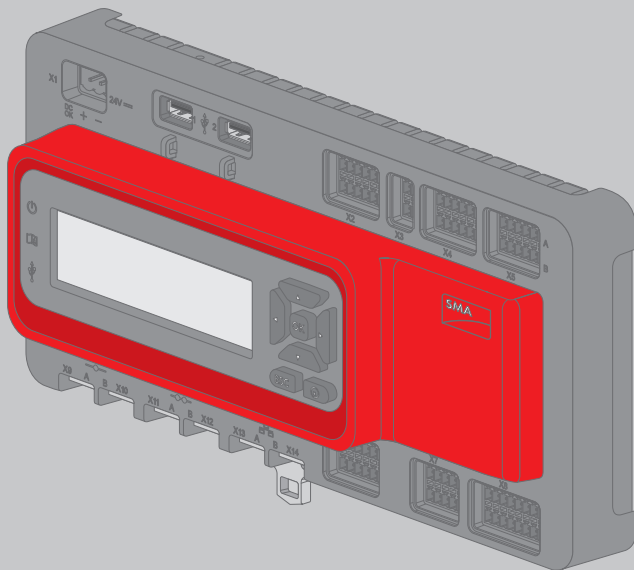

Legal Provisions

The information contained in these documents is property of SMA Solar Technology AG. Any publication, whether in whole or in part, requires prior written approval by SMA Solar Technology AG. Internal reproduction used solely for the purpose of product evaluation or other proper use is allowed and does not require prior approval.

SMA Warranty

You can download the current warranty conditions from the Internet at www.SMA-Solar.com.

Software Licenses

The licenses for the software modules used with this product can be found on the supplied CD.

Trademarks

All trademarks are recognized, even if not explicitly identified as such. A lack of identification does not mean that a product or symbol is not trademarked.

The BLUETOOTH® word mark and logos are registered trademarks of Bluetooth SIG, Inc. and any use of these marks by SMA Solar Technology AG is under license.

Modbus® is a registered trademark of Schneider Electric and is licensed by the Modbus Organization, Inc.

QR Code is a registered trademark of DENSO WAVE INCORPORATED.

Phillips® and Pozidriv® are registered trademarks of Phillips Screw Company.

Torx® is a registered trademark of Acument Global Technologies, Inc.

SMA Solar Technology AG

Sonnenallee 1

34266 Niestetal

Germany

Tel. +49 561 9522-0

Fax +49 561 9522-100

www.SMA.de

E-mail: info@SMA.de

© 2004 to 2015 SMA Solar Technology AG. All rights reserved.

Table of Contents

1	Information on this Document	8
1.1	Validity	8
1.2	Target group.....	8
1.3	Additional Information	8
1.4	Symbols	8
1.5	Typographies.....	9
1.6	Nomenclature.....	9
2	Safety.....	10
2.1	Intended Use	10
2.2	Safety Information	10
2.3	Operating Information	11
2.4	System Requirements	11
3	Product Description.....	12
3.1	Cluster Controller	12
3.1.1	Functions	12
3.1.2	Type Label	17
3.1.3	LEDs.....	18
3.1.4	Display.....	19
3.1.5	Keypad	20
3.2	Sunny Portal.....	21
4	User Interface of the Cluster Controller	22
4.1	User Groups and User Rights.....	22
4.2	Overview of the User Interface	23
4.2.1	Structure.....	23
4.2.2	Toolbar	24
4.2.3	System Tree	24
4.2.4	Device Menu	26
4.2.4.1	Overview Menu	26
4.2.4.2	Instantaneous Values Menu	27
4.2.4.3	Settings Menu	27
4.2.4.4	Updates Menu	27
4.2.4.5	Grid Management Services Menu	28

4.2.4.6	Events Menu.....	31
4.2.4.7	Update and Save Menu	32
4.2.4.8	Parameter Groups of the Menus	32
4.2.5	Symbols	33
5	Logging Into or Out of the Cluster Controller.....	35
6	System Settings	36
6.1	Display Settings.....	36
6.1.1	Setting the Display Language	36
6.1.2	Adjusting the Display Contrast.....	36
6.2	Setting the User Interface Language.....	36
6.3	Setting the Date Format	37
6.4	Setting the Number Format	37
6.5	Setting the Time Format	37
6.6	Setting the Temperature Unit.....	38
6.7	Settings for System Time	38
6.7.1	Information on System Time	38
6.7.2	Synchronizing System Time via the Internet	38
6.7.3	Manually Setting the System Time	39
7	Device Configuration.....	40
7.1	Setting the Characteristic Curve of the Irradiation Sensor.....	40
7.2	Parameter Settings	40
7.2.1	Setting Parameters for a Device Class.....	40
7.2.2	Setting the Parameters of an Individual Device	41
7.3	Deactivating the Webconnect Function of the Inverters	41
7.4	Saving and Restoring the Device Configuration of the Cluster Controller.....	42
8	Exporting System Data.....	44
8.1	Export Options	44
8.2	Export Formats.....	44
8.2.1	CSV Format	44
8.2.2	XML Format	45
8.3	Setting the Measured Value Name	47
8.4	Exporting System Data to a USB Data Carrier	47

8.5	Exporting System Data to the Integrated FTP Server	48
8.5.1	Setting the Export Format for System Data.....	48
8.5.2	Activating or Deactivating the Integrated FTP Server	48
8.5.3	Accessing the Integrated FTP Server via the Web Browser	48
8.6	Additionally Exporting System Data to an External FTP Server (FTP Push).....	49
8.6.1	Activating or Deactivating the FTP Push Function.....	49
8.6.2	Testing the FTP Push Function	50
9	System Monitoring.....	51
9.1	Displaying Events	51
9.2	Setting Alarms	51
10	System Management and Replacing Components.....	53
10.1	Changing System Names or Device Names.....	53
10.2	Use of SMA Energy Meters in the System	53
10.3	Reading Off the Type, Serial Number and Firmware Version of the Devices	53
10.4	IP Addresses of the Devices.....	54
10.4.1	Reading Off the IP Address of the Cluster Controller.....	54
10.4.2	Reading Off the IP Address of the Inverter.....	54
10.5	Adding an Inverter	55
10.6	Replacing the Cluster Controller or an Inverter.....	55
11	Sunny Portal.....	56
11.1	Registering the Cluster Controller in Sunny Portal.....	56
11.2	Setting Data Transmission to Sunny Portal	57
11.3	Setting Communication Monitoring	57
11.4	Setting the Upload Frequency.....	58
11.5	Testing the Connection to Sunny Portal	58
11.6	Adjusting the System Identifier for Sunny Portal.....	59
12	Modbus Configuration	60
12.1	Activating the Modbus Server.....	60
12.2	Saving or Updating the Modbus Profile and System Configuration.....	60

13	Grid Management Services	62
13.1	Options for Implementing Grid Management Service Setpoints	62
13.2	Setting Parameters for Grid Management Services in the Inverters	63
13.3	Settings for Active Power Limitation	64
13.3.1	Controlling Active Power Limitation	64
13.3.2	Regulating Active Power Limitation at the Grid-Connection Point	65
13.4	Settings for Reactive Power Setpoint	68
13.4.1	Controlling Reactive Power via the Setpoint "Reactive Power in %"	68
13.4.2	Controlling Reactive Power via the Setpoint "cos Phi"	69
13.5	Making Settings for Fallback.....	70
14	Update	73
14.1	Automatic Update (Recommended)	73
14.1.1	Setting the Automatic Update for Cluster Controller	73
14.1.2	Setting the Automatic Update for Connected SMA Devices	73
14.2	Manual Update.....	75
14.2.1	Carrying Out a Manual Update for Cluster Controller.....	75
14.2.2	Performing a Manual Update for Connected SMA Devices	76
15	Passwords and SMA Grid Guard	79
15.1	Requirements for a Secure System Password.....	79
15.2	Changing the System Password.....	79
15.3	Adapting the Device Password to the System Password.....	80
15.4	Procedure on Loss of System Passwords	81
15.4.1	Requesting a PUK	81
15.4.2	Unlocking Inverters with PUKs.....	81
15.5	Setting SMA Grid Guard Mode	83
16	Setting Up Access via the Internet	84
17	Network Configuration	86
17.1	Configuration for Static LAN	86
17.1.1	Configuring the Cluster Controller for Static LAN.....	86
17.1.2	Configuring the Inverter for a Static LAN	87

- 17.2 Making the Proxy Configuration 87
- 17.3 Making the DHCP Configuration 88
- 17.4 Changing the HTTP Port..... 88
- 17.5 Changing the NAT Port 88
- 18 Troubleshooting 90**
 - 18.1 LED States 90
 - 18.1.1 Operation LEDs 90
 - 18.1.2 Network Port LEDs 95
 - 18.2 Errors in the Cluster Controller or the Connected Devices 96
 - 18.3 Restarting the Cluster Controller via the User Interface108
 - 18.4 Resetting the Cluster Controller109
- 19 Accessories110**
- 20 Contact.....111**

1 Information on this Document

1.1 Validity

This document is valid for the SMA Cluster Controller (models "CLCON-10" and "CLCON-S-10") from hardware version A1 and from firmware version 1.03.xx.R.

1.2 Target group

The tasks described in this document must only be performed by qualified persons. Qualified persons must have the following skills:







- Training in the installation and configuration of IT systems
- Knowledge of how an inverter works and is operated
- Training in how to deal with the dangers and risks associated with installing and using electrical devices and installations
- Training in the installation and commissioning of electrical devices and installations
- Knowledge of the applicable standards and directives
- Knowledge of and compliance with this document and all safety information

1.3 Additional Information

Links to additional information can be found at www.SMA-Solar.com:

Document title	Document type
"Replacement of SMA Devices in Systems with Communication Products"	Installation Manual

1.4 Symbols

Symbol	Explanation
	Indicates a hazardous situation which, if not avoided, will result in death or serious injury
	Indicates a hazardous situation which, if not avoided, can result in death or serious injury
	Indicates a hazardous situation which, if not avoided, can result in minor or moderate injury
	Indicates a situation which, if not avoided, can result in property damage
	Information that is important for a specific topic or goal, but is not safety-relevant
	Indicates a requirement for meeting a specific goal

Symbol	Explanation
☑	Desired result
✘	A problem that might occur

1.5 Typographies

Typography	Use	Example
bold	<ul style="list-style-type: none"> • Display texts • Elements on a user interface • Terminals • Elements to be selected • Elements to be entered 	<ul style="list-style-type: none"> • The value can be found in the field Energy. • Select Settings. • Enter 10 in the field Minutes.
>	<ul style="list-style-type: none"> • Connects several elements to be selected 	<ul style="list-style-type: none"> • Select Settings > Date.
[Button] [Key]	<ul style="list-style-type: none"> • Button or key to be selected or pressed 	<ul style="list-style-type: none"> • Select [Next].

1.6 Nomenclature

Complete designation	Designation in this document
Large-scale PV power plant	PV system
PV inverter	Inverter
SMA Cluster Controller	Cluster Controller
SMA Energy Meter	Energy Meter

2 Safety

2.1 Intended Use

The Cluster Controller is a device for monitoring and controlling SMA inverters with Speedwire/ Webconnect interfaces in decentralized PV systems and large-scale PV power plants.

The Cluster Controller is an ITE class A device as per EN 55022 and is designed for industrial use. The product is designed for indoor use only.

Use this product only in accordance with the information provided in the enclosed documentation and with the locally applicable standards and directives. Any other application may cause personal injury or property damage.

Alterations to the product, e.g. changes or modifications, are only permitted with the express written permission of SMA Solar Technology AG. Unauthorized alterations will void guarantee and warranty claims and in most cases terminate the operating license. SMA Solar Technology AG shall not be held liable for any damage caused by such changes.

Any use of the product other than that described in the Intended Use section does not qualify as appropriate.

The enclosed documentation is an integral part of this product. Keep the documentation in a convenient place for future reference and observe all instructions contained therein.

The type label must remain permanently attached to the product.

2.2 Safety Information

This section contains safety information that must be observed at all times when working on or with the product.

To prevent personal injury and property damage and to ensure long-term operation of the product, read this section carefully and observe all safety information at all times.

DANGER

Danger to life due to electric shock from touching an ungrounded product

Touching an ungrounded product can cause a lethal electric shock.

- Ensure that the product is integrated in the existing overvoltage protection.
- Ground the enclosure of the product.

NOTICE

Damage to the product due to moisture

The product is not splash-proof (IP20). Moisture can penetrate the product and damage it.

- Only use the product in a dry, indoor environment.

2.3 Operating Information

NOTICE

High costs possible due to inappropriate Internet tariffs

Depending on use, the data volume of the Cluster Controller transferred via the Internet can be more than 1 GB per month. The data volume depends, among other things, on the number of connected inverters, the frequency of device updates, the frequency of data transfer to Sunny Portal and the use of FTP push.

- SMA Solar Technology AG recommends using an Internet flat rate.

2.4 System Requirements

Supported web browsers:

- Microsoft Internet Explorer from version 8
- Mozilla Firefox from version 3.6

Recommended display resolution:

- Minimum 1,024 pixels x 768 pixels

3 Product Description

3.1 Cluster Controller

3.1.1 Functions

The Cluster Controller is a device for monitoring and controlling SMA inverters with Speedwire/ Webconnect interfaces in decentralized PV systems and large-scale PV power plants.

The Cluster Controller primarily performs the following tasks:

- Set-up of the Speedwire network
- Reading out, provision and administration of PV system data
- Configuring device parameters
- Feedback on current total active power of the system
- Implementation and feedback of grid operator setpoints for active power limitation and reactive power operation under grid management services
- Implementation and feedback of setpoints for active power limitation when PV electricity is directly marketed
- Sending e-mail alarms in the event of critical system statuses
- Sending the system data to an FTP server and/or the Sunny Portal Internet portal
- Performing updates for the Cluster Controller and the inverters

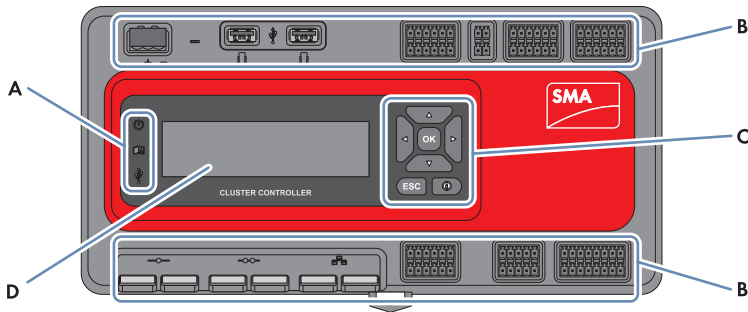

Figure 1: Design of the Cluster Controller

Position	Designation
A	LEDs
B	Connection areas
C	Keypad
D	Display

Reading out, provision and administration of PV system data

The Cluster Controller is the central communication unit for the system and continuously reads out the data of the devices in the system (e.g. inverters, sensors). The Cluster Controller then makes this system data available via the display, user interface and Modbus data interface. In addition, the PV system data can be displayed, evaluated and managed using Sunny Portal.

Configuring device parameters

You can configure specific parameters of individual devices or entire device classes via the user interface of the Cluster Controller. You must be logged into the user group **Installer** on the Cluster Controller. The device parameters that can be configured, if any, depend on the device and the rights of the user group. You may only change grid-sensitive device parameters (SMA Grid Guard parameters) with the approval of the grid operator and using your personal SMA Grid Guard code.

Sending e-mail alarms in the event of critical system statuses

You have the option of receiving prompt information on critical system statuses via e-mail. The Cluster Controller automatically sends a notification if alarm-related events occur in the system.

Feedback on current total active power of the system

You have the option of being informed of the total active power currently generated by the system via an analog current output signal.

Implementation and feedback of grid operator setpoints for active power limitation and reactive power operation under grid management services

With the Cluster Controller, as part of grid management services you can implement different grid operator setpoints for active power limitation and reactive power operation of your system. The Cluster Controller can implement the setpoints using open-loop control or closed-loop control.

For Cluster Controller systems without self-consumption and with direct limitation of active power feed-in, the operating mode **Open-loop control** is used. In this operating mode, the Cluster Controller can receive the setpoints either in the form of digital or analog signals, or via Modbus. The different types of signal source can be combined so that, for example, the setpoints for the active power limitation are received as digital signals and the reactive power setpoints are received as analog signals: For Cluster Controller systems with self-consumption, the operating mode **Closed-loop control** is used. In this operating mode, you can regulate the active power fed in by the system at the grid-connection point and limit it e.g. to a fixed percentage value. In agreement with your grid operator, you can use the user interface of the Cluster Controller to configure which setpoints of the Cluster Controller are to be transmitted to the connected inverters depending on the respective signal. In addition, you can use a digital response contact or an analog current output signal to inform the grid operator of the setpoints (if any) for active power limitation and reactive power operation that are currently being used in the system.

Implementation and feedback of setpoints for active power limitation when PV electricity is directly marketed

The PV current generated by your system can be directly marketed. The Cluster Controller can receive setpoints for active power limitation from the direct marketer as digital or analog signals or via Modbus. The "CLCON-S-10" model provides a Modbus register for sending setpoints via Modbus. The model "CLCON-10" provides two Modbus registers.

The Cluster Controller can provide feedback about the current feed-in power of the system to the direct marketer via digital or analog signals. To avoid conflicts when different setpoints are used by the grid operator and the direct marketer, the Cluster Controller always implements the setpoint that more strongly limits the active power of the system.

Sending the system data to an FTP server and/or the Sunny Portal Internet portal

The Cluster Controller can automatically send the system data that has been read out to an arbitrary FTP server and/or the Sunny Portal Internet portal via the Internet. The Cluster Controller establishes the connection to the FTP server and/or Sunny Portal e.g. via a router.

Performing updates for the Cluster Controller and the inverters

You have the option of performing updates for the Cluster Controller and the inverters in the system. You can perform the updates automatically or manually. The update source can be the SMA Update Portal or a USB data carrier with update files downloaded from the Internet. Alternatively, you can also upload the update files directly from the computer via the user interface of the Cluster Controller.

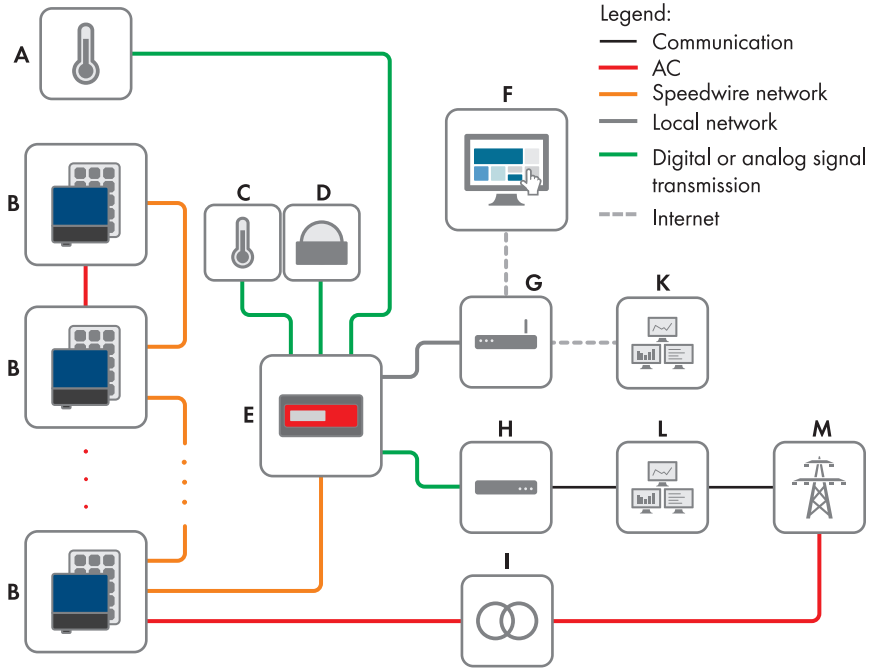

Figure 2: Decentralized large-scale PV power plant with Cluster Controller and implementation of grid operator setpoints via open-loop control (example)

Position	Designation
A	PV Modules
B	Module temperature sensor
C	Inverter
D	Outside temperature sensor
E	Irradiation sensor
F	Cluster Controller
G	Sunny Portal
H	Router
I	Ripple control receiver or remote terminal unit
K	Grid station
L	Control room
M	Grid control room
N	Utility grid

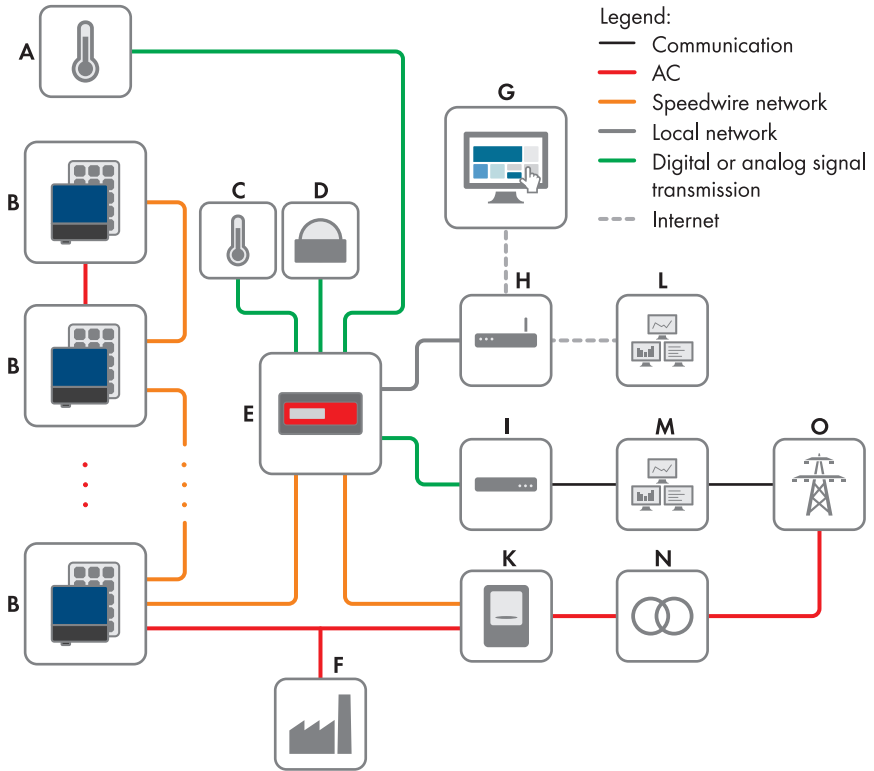

Figure 3: Decentralized large-scale PV power plant with Cluster Controller and implementation of grid operator setpoints via closed-loop control (example)

Position	Designation
A	PV Modules
B	Module temperature sensor
C	Inverter
D	Outside temperature sensor
E	Irradiation sensor
F	Cluster Controller
G	Industrial load
H	Sunny Portal
I	Router
K	Ripple control receiver or remote terminal unit

Position	Designation
L	Energy meter
M	Control room
N	Grid control room
O	Grid station
P	Utility grid





3.1.2 Type Label



The type label clearly identifies the product. The type label can be found on the back of the enclosure. You can read off the following data from the type label:

- Device type (Type)
- Serial Number
- Hardware version (Version)
- Model
- Device-specific characteristics

You will require the information on the type label to use the product safely and when seeking customer support from Service (see Section 20 "Contact", page 111).



Symbols on the Type Label

Symbol	Designation	Explanation
	C-Tick	The product complies with the requirements of the applicable Australian EMC standards.
CAN ICES-3 (A)/ NMB-3(A)	IC marking	The product complies with the requirements of the applicable Canadian EMC standards.
	Indoors	The product is only suitable for indoor installation.
	FCC designation	The product complies with the requirements of the applicable FCC standards.
	CE marking	The product complies with the requirements of the applicable EU directives.

Symbol	Designation	Explanation
	WEEE designation	Do not dispose of the product together with household waste but in accordance with the locally applicable disposal regulations for electronic waste.
	Data matrix code	2D code for device-specific characteristics

3.1.3 LEDs

Operation LEDs

LED	Designation	Explanation
	Power LED	Shows whether the Cluster Controller is starting or is in operation (see Section 18.1 "LED States", page 90)
	Status LED	Shows the status of the Cluster Controller and the connected devices as well as the communication status of the system and the status of the grid management services (see Section 18.1 "LED States", page 90)
	Data carrier status LED	Shows the status of the connected USB data carrier (see Section 18.1 "LED States", page 90)

Network Port LEDs

i Colors and functionality of the network port LEDs are not standardized

The colors and functionalities of the network port LEDs are not standardized. The colors used by SMA for the link/activity LED and the speed LED as well as the corresponding functionalities can deviate in products supplied by third-party manufacturers.

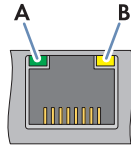

Figure 4: Network port LEDs

Position	Designation	Color	Explanation
A	Link/activity LED	Green	Shows the status and the activity of the network connection (see Section 18.1.2 "Network Port LEDs", page 95)
B	Speed LED	Yellow	Shows the network connection speed (see Section 18.1.2 "Network Port LEDs", page 95)

3.1.4 Display

The display shows information on the Cluster Controller and the connected devices as well as the system status and the system configuration. The display contrast can be configured. The display languages are "German" and "English". You can change the display language via the Cluster Controller user interface.

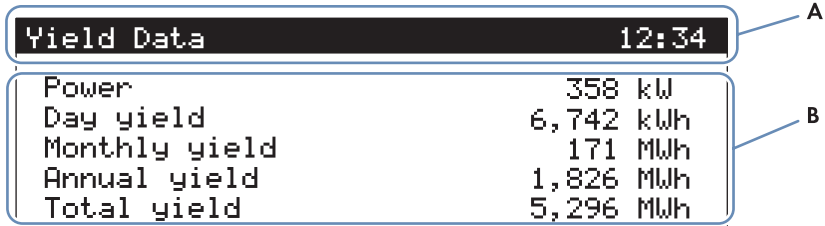

Figure 5: Cluster Controller display (example)

Position	Designation	Explanation
A	Title line	Displays the title of the display view The system time is always displayed.
B	Data lines	Displays text and numeric values The numeric values for measurement or yield data are displayed with units.

Overview of the Display Views

Display view	Explanation
Start view	Displayed when the Cluster Controller starts up; includes the current firmware version of the Cluster Controller

Display view	Explanation
System overview	Displays the system status, the current daily yield, the nominal system power and the current setpoints for active power and reactive power If no button on the keypad is pressed within five minutes, the Cluster Controller switches to the display view System overview .
Yield data	Displays the yield data of the system
System status	Displays the current system status The number of inverters detected by the Cluster Controller and the status of the inverters is displayed here.
Cluster Controller	Displays the status and device information of the Cluster Controller When a USB data carrier is inserted into USB port 1 , information on the current memory usage of the USB data carrier will be displayed.
Sunny Portal settings	Displays the configured upload frequency and the date of the last successful data upload to Sunny Portal
Analog inputs	Displays the analog inputs with the current level value and unit
Digital inputs	Displays the digital inputs in binary form The digital inputs are summarized in two groups here.
Meteorology	Displays the measured values of the connected irradiation sensor and the connected temperature sensors
Active power limitation	Displays the current setpoint for active power limitation with the setpoint size and the date of the last configuration change
Reactive power setpoint	Displays the current reactive power setpoint and the date of the last configuration change
Grid management services	Displays the setpoint type and the signal sources selected via the Cluster Controller user interface for the grid management services
External communication	Displays the settings for the LAN
Speedwire	Displays the settings for the Speedwire network
Modbus settings	Displays the Modbus settings with the activated network protocols and the corresponding network ports
Settings	Enables the display contrast to be changed and the Cluster Controller to be partially or fully reset (see Section 18.4, page 109)

3.1.5 Keypad

Designation	Explanation
Any button	Activates the display illumination
Arrow buttons (◀ ▶ ▲ ▼)	Changes display views and selects specific display lines

Designation	Explanation
[OK]	Confirms the selected action
[ESC]	Cancels the selected action
ⓘ	Opens the display view System status

3.2 Sunny Portal

Sunny Portal (www.SunnyPortal.com) is an Internet portal which allows you to monitor systems and to visualize and present system data.

Sunny Portal visualizes data and energy balances of selected loads in the household.

Sunny Portal serves as the user interface for configuring the Sunny Home Manager and the loads. Sunny Portal transmits the configurations to the Sunny Home Manager. The Sunny Home Manager transmits the configuration to the radio-controlled sockets. In this way, the loads are able to be switched on and off via Sunny Portal.

Sunny Portal supports both SMA radio-controlled sockets and Plugwise radio-controlled sockets.

Sunny Portal visualizes data from components of the SMA Smart Home, the SMA Flexible Storage System and the SMA Integrated Storage System. In addition, data from battery management systems such as Sunny Island and Sunny Boy Smart Energy can be displayed in clearly arranged diagrams.

In order to use Sunny Portal, you will need an SMA product that can record your system data and send it to Sunny Portal, e.g. the Cluster Controller. Depending on the SMA product that sends the data, various functions are available in Sunny Portal.

In order to use Sunny Portal, the Cluster Controller must be registered in Sunny Portal. You can access the Cluster Controller via the Internet using Sunny Portal (see Section 16, page 84). In addition, Sunny Portal can monitor the operation of the Cluster Controller. For this communication monitoring, the Cluster Controller sends a signal to Sunny Portal at a time interval specified by the user. If the signal fails to arrive, Sunny Portal alerts the user via e-mail depending on the strictness of the communication monitoring configured in Sunny Portal (see user manual of the Cluster Controller in Sunny Portal).

4 User Interface of the Cluster Controller

4.1 User Groups and User Rights

The Cluster Controller distinguishes between the user groups **User** and **Installer**. To prevent two users from making changes at the same time via the user interface, only one user can ever be logged into the Cluster Controller at a time.

The user groups have the following rights:

Right	User group	
	User	Installer
Making system settings in the Cluster Controller	✓	✓
Configuring the Cluster Controller for the local area network (see Section 17.1.1, page 86)	✓	✓
Changing the HTTP port (see Section 17.4, page 88) or the NAT port (see Section 17.5, page 88)	✓	✓
Reading off the inverter power and the inverter parameter settings via the device menu (see Section 4.2.4, page 26)	✓	✓
Setting the inverter parameters (see Section 7, page 40)	–	✓
Changing the SMA Grid Guard parameters of devices (see Section 15.5, page 83)	–	Only with SMA Grid Guard code: ✓
Adding devices to the system or replacing devices in the system (see Section 10, page 53)	–	✓
Changing the system password for the user group User (see Section 15.2, page 79)	✓	✓
Changing the system password for the user group Installer (see Section 15.2, page 79)	–	✓
Restarting the Cluster Controller via the user interface (see Section 18.3, page 108)	–	✓

4.2 Overview of the User Interface

4.2.1 Structure

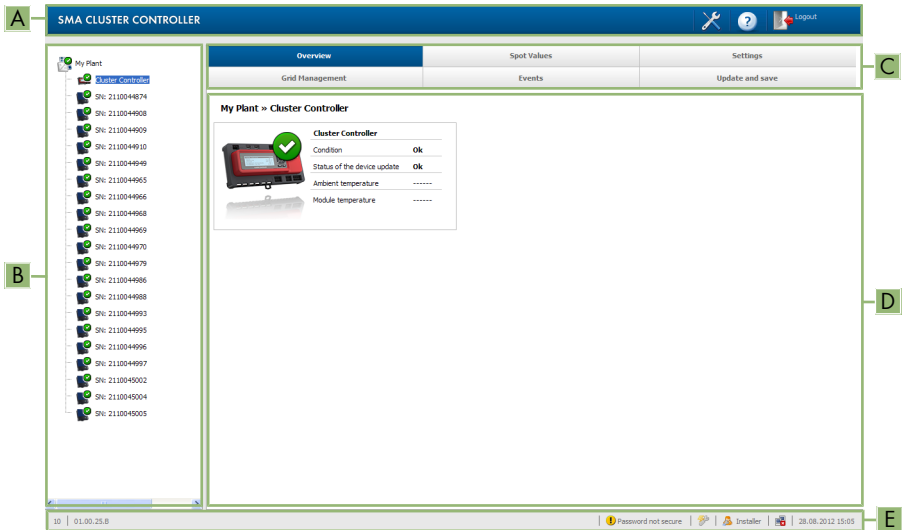





Figure 6: User interface of the Cluster Controller (example)

Position	Designation	Explanation
A	Toolbar	Provides access to the main functions of the Cluster Controller
B	System tree	Presents all devices in the system in a tree structure
C	Device menu	Provides various device information and configuration options for the selected devices in the system tree (B) via individual menus

Position	Designation	Explanation
D	Content area	Displays the content of the selected menu
E	Status bar	<p>Displays the following information:</p> <ul style="list-style-type: none"> Serial number of the Cluster Controller Firmware version of the Cluster Controller* <p>After login to the user interface, the following additional information is displayed:</p> <ul style="list-style-type: none"> System password security Update information For the user group Installer with SMA Grid Guard code: SMA Grid Guard symbol (🔑) User group Status of connection to system Date and time

* If the automatic update of the Cluster Controller is activated (see Section 14.1.1, page 73) and a new firmware version is available, the new firmware version is displayed in brackets after the current firmware version.

4.2.2 Toolbar

Symbol	Designation	Explanation
	Settings	Opens the menu Settings for the Cluster Controller
	Help	Opens a dialog box with information on the Cluster Controller product documentation (user manual and installation manual)
	Logout	Logs the user out of the user interface

4.2.3 System Tree

In the system tree, all devices in a system are represented in a tree structure. The system tree is divided into the hierarchy levels, "System View" and "Device View".

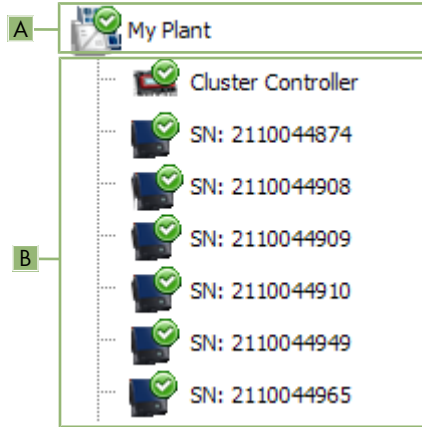



Figure 7: Layout of the system tree (example)

Position	Designation	Explanation
A	System view	Depicts the first hierarchy level of the system tree and summarizes all devices in the system The system name is displayed on this hierarchy level.
B	Device view	Depicts the hierarchy level subordinate to the system view The communication product is displayed first, followed by the inverters in the system. The serial number of the device is displayed as the default device name. You can change the device name (see Section 10.1, page 53).

Status symbols in the system tree

Symbol	Designation	Explanation
–	Neutral	The system status or the device status is unknown and is currently being updated.
	OK	The device is operating properly.
	Warning	At least one device in the system has the status Warning . The affected device is currently not operating properly. It may be possible to remedy this status automatically.

Symbol	Designation	Explanation
	Error	At least one device in the system has the status Fault . There is a problem with this device that could not be eliminated yet.
	Communication error	The device cannot communicate at present. This can happen at night, for example, when the inverter is not feeding in. This symbol will also be displayed if you have decommissioned the device, e.g. for replacement. To remove the device from the system tree, select [Remove] (for information on replacing the Cluster Controller or an inverter in the Cluster Controller system, see the Installation Manual ""Replacement of SMA Devices in Systems with Communication Products"" at www.SMA-Solar.com).



4.2.4 Device Menu

4.2.4.1 Overview Menu

Depending on whether you have selected the system view or the device view in the system tree, the menu **Overview** displays the most important information on the overall system or on the selected device.

When a device is selected in the system tree, the yield and output values of that device are also displayed in four diagrams on the overview page.

Selecting power values for specific times or intervals

Action, button or symbol	Explanation
Use the mouse to point at or click on a part of the diagram sequence	Display the exact power value of the selected part, the corresponding time and the date
	Browse to the previous time period for power values
	Browse to the next time period for power values
	Directly select the time period for the power values

4.2.4.2 Instantaneous Values Menu

Instantaneous values are measured or calculated values for the device, such as temperature and power. Different information is displayed depending on whether the system view or the device view is selected in the system tree. The values that are displayed depend on the user group and the selected device. All values are summarized in expandable parameter groups (see Section 4.2.4.8, page 32).

Selected view in the system tree	Explanation
System view	Displays values for complete device classes These values are partly compiled from the individual values of the respective devices. These values are indicated using the arrow symbol ► and can be expanded in order to display additional information on the value. When you click on the parameter group, the device classes are displayed separately (e.g. System communication (Communication products)).
Device view	Displays values for the individual device

4.2.4.3 Settings Menu

Depending on whether the system view or the device view is selected in the system tree, the menu **Settings** displays all configurable parameters of the selected system or of the device selected in the system tree. The parameters that are displayed depend on the user group and the selected device. All parameters are summarized in expandable parameter groups (see Section 4.2.4.8, page 32). For numerical values, the permissible parameter limits are displayed in brackets after the value.

Selected view in the system tree	Displayed information
System view	List of all parameters of a device class When you click on the parameter group, the device classes are displayed separately (e.g. PV inverters and Communication products).
Device view	List of all parameters of the selected device

4.2.4.4 Updates Menu

The menu **Updates** is only displayed if the system view is selected in the system tree. In the menu **Updates**, you can display the current firmware version of the devices in your system and make settings for the device updates. All available devices in the system are listed grouped by device type. You can also view available device updates, download them, and transmit them to the devices.

Update status of the devices

Update status	Explanation
Ok	No update files are available or the update function is not activated.

Update status	Explanation
Update available	The update file is ready for sending to the devices in the system.
Update in process	The update process is running.
Update failed	The update process was not successful. The update file could not be sent to all devices in the system.

Status of the update file

Status	Explanation
Download available	The update file is available for downloading.
Ready	The update file has been downloaded and can be sent to the devices in the system.
Sending	The update file is being sent to the devices in the system.
Waiting	The update file is in the queue and will be sent to the devices in the system as soon as possible.

4.2.4.5 Grid Management Services Menu

In the menu **Grid management services**, you can make settings for grid management services (e.g. setpoints for active power limitation or the reactive power setpoint). The menu **Grid management services** is only displayed if the Cluster Controller is selected in the system tree.

Configurable parameters for digital and analog inputs

Parameter	Explanation
Time interval for the output value	Indicates the time interval at which the control command with the current output value is to be sent to the inverters providing that the setpoint sent by the signal generator has not changed

Configurable parameters for digital inputs

Parameter	Explanation
Failure tolerance time	Indicates the time as of which an invalid input status is recorded as a fault.

Configurable parameters for analog inputs

Parameter	Explanation
Failure tolerance time	Indicates the time as of which an invalid input status is recorded as a fault.
Initial value input signal	Initial value for the input signal
Final value input signal	Final value for the input signal

Parameter	Explanation
Start setpoint active power limitation	Lower limit for the setpoint for the active power limitation related to the inverter parameter Set active power limit or Pmax
End setpoint active power limitation	Upper limit for the setpoint for the active power limitation related to the inverter parameter Set active power limit or Pmax
For reactive power setpoint in %: Start setpoint reactive power	Lower limit for the setpoint for the reactive power setpoint related to the inverter parameter Set active power limit or Pmax
For reactive power setpoint in %: End setpoint reactive power	Upper limit for the setpoint for the reactive power setpoint related to the inverter parameter Set active power limit or Pmax
For setpoint cos Phi: Cos Phi start setpoint	Lower limit for the setpoint of the displacement power factor $\cos \varphi$
For setpoint cos Phi: Cos Phi end setpoint	Upper limit for the setpoint of the displacement power factor $\cos \varphi$
For setpoint cos Phi: Excitation type	Direction of phase shift

Example of the importance of lower and upper limits for setpoints

4 mA is set as the initial value for the active power limitation setpoint and 16 mA is set as the end value for the active power limitation setpoint. If the grid operator sends a signal of 3.5 mA to the Cluster Controller, the Cluster Controller then classifies this signal as 4 mA because the value of 4 mA is set as the lower limit for the active power limitation setpoint. If the grid operator sends a signal of 17 mA to the Cluster Controller, the Cluster Controller then classifies this signal as 16 mA because the value of 16 mA is set as the upper limit for the active power limitation setpoint.

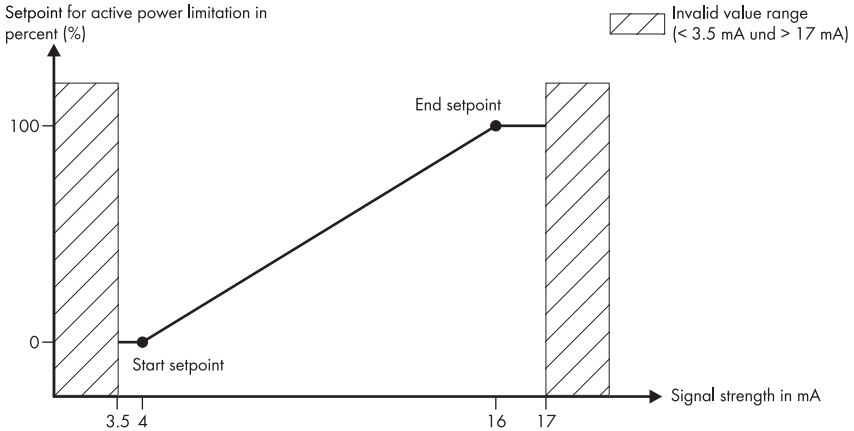



Figure 8: Example of the importance of the lower and upper limits for setpoints related to the inverter parameter **Set active power limit** or **Pmax**

Configurable parameters for active power control

Parameter	Explanation
Activated	<p>Switches the active power control on or off</p> <p>When the active power control is switched on, the active power setpoint is being implemented gradually in accordance with your additional settings in the group Settings for active power control.</p> <p>When the active power control is switched off, the active power setpoint is implemented immediately.</p>
Time interval in the event of a changed setpoint	<p>Indicates the time interval at which the control command with the new output value is to be sent to the inverters once the setpoint sent by the signal generator changes</p> <p>The first output value is sent to the inverter immediately after the setpoint is changed. If additional output values are required in order to reach the setpoint, these will be sent at the specified time interval. This enables, for example, an incremental increase in the active power.</p>
Max. change in case of power increase	<p>Indicates the maximum change in percentage points per time interval that occurs once an active power limitation setpoint has been canceled</p>
Max. change in case of power reduction	<p>Indicates the maximum change in percentage points per time interval that occurs once an active power limitation setpoint has been received</p>









Status configuration

Symbol	Explanation
	Corresponds to the value "Logical 1" (= 24 V)
	Corresponds to the value "Logical 0" (= 0 V)



4.2.4.6 Events Menu

In the menu **Events**, Cluster Controller events or inverter events in the system are displayed in the form of an event log. The Cluster Controller requests the events list from the inverters directly. The events displayed in each case depend on the inverter that is selected in the system tree, on the user group, and on the filter settings for the event types (**Information**, **Warning**, **Error**).

Event Types

Symbol	Designation	Explanation
	Error	The Error event has existed for some time and could not yet be remedied.
	Incoming error	An Error event has occurred.
	Outgoing error	The Error event no longer exists.
	Warning	The Warning event has existed for some time and could not yet be automatically remedied.
	Incoming warning	The Warning event has occurred.
	Outgoing warning	The Warning event no longer exists.
	Information	The Information event has existed for some time.
	Incoming information	The Information event has occurred.
	Outgoing information	The Information event no longer exists.

Severity of the Event

Symbol	Explanation
	This event can only be rectified by a user with Installer rights (see Section 9.1, page 51).
	This event can only be rectified by SMA Service (see Section 9.1, page 51).









4.2.4.7 Update and Save Menu











In the menu **Update and save**, you have the following options:

Parameter group	Option
Update	Perform an update for the Cluster Controller via the user interface (see Section 14, page 73).
Device configuration	Save or restore the device configuration of the Cluster Controller (see Section 7.4, page 42)
Modbus	Update or save the Modbus profiles or system configurations (see Section 12.2, page 60)

4.2.4.8 Parameter Groups of the Menus



Depending on whether you have selected the system view or the device view in the system tree, either the parameters of entire device classes or the parameters of the selected device will be displayed in the parameter groups. The parameter groups that are displayed in the menu and the information contained in the parameter groups depend on the devices available in the system or the device selected in the system tree.

Symbol	Designation	Explanation
	Status	General information on device status
	Type label	All values that identify the device/system
	Settings	Update settings
	Device	Values that directly affect the device and that cannot be assigned to any of the other parameter groups (e.g. DC side)
	User rights	All values that affect access to the device or the system
	DC side	Values that affect the DC side of the inverter or the system
	AC side	Values that affect the AC side of the inverter or the system
	Grid monitoring	Information that affects the utility grid and is partially protected by the personal SMA Grid Guard code
	System communication	Values that define the communication between the communication devices and the system, as well as information on the update status of the device







Symbol	Designation	Explanation
	External communication	Values that define the communication between the system, the local network and the Internet
	Data logging	Values that affect data logging for the device (e.g. the storage format)
	Sunny Portal	Values for Sunny Portal communication
	Further Applications	Values that cannot be assigned to any of the other groups (e.g. alarm)
	Meteorology	All measured values from the connected sensors (e.g. irradiation values)
	Device components	All parameters and measured values that affect the components of a device (e.g. the version numbers of the components)
	System and device control	Includes parameters for inverters that must fulfill special requirements for grid feed-in at the medium voltage level. These parameters are protected by the personal SMA Grid Guard code.
	Grid connection	Definition of measurement source for system active power at the grid-connection point
	General settings	Contains parameters for system control within the scope of grid management services
	Active power	All values that affect the active power limitation setpoints
	Reactive power	All values that affect the reactive power setpoints

4.2.5 Symbols









Symbols for access rights

Symbol	Designation	Explanation
	Padlock symbol	Not possible to access the device The device password does not match the system password.
	SMA Grid Guard symbol	Indicates that the logged in user has the right to change grid-sensitive device parameters (SMA Grid Guard parameters)

Device symbols

Symbol	Explanation
	Complete system
	Cluster Controller
	Energy Meter
	Inverter (example)
	Unknown inverter
	Unknown device If necessary, update the firmware of the Cluster Controller (see Section 14, page 73) so that the device is displayed with the correct symbol.

Other symbols

Symbol	Designation	Explanation
	Hourglass	Indicates that values are currently being saved in the device
	Average value	Displays the average value
	Total	Displays aggregated values
	Maximum	Displays the maximum value
	Minimum	Displays the minimum value
	Update	Indicates that an action is currently being performed or that device values are currently being read out
	Stopwatch	Indicates that a value is from more than ten minutes ago
	Calendar function	Opens a calendar for selecting a date or a start and end date

5 Logging Into or Out of the Cluster Controller

Logging Into the Cluster Controller

1. If the IP address of the Cluster Controller is unknown, read off the IP address of the Cluster Controller from the display and write it down. Select the display view **External communication** and read off and write down the IP address.

2. Call up the IP address of the Cluster Controller via the web browser.

The login page opens:

The login page does not open?

Possible error cause: you have not written down the IP address correctly or you have not entered it correctly.

- Enter the correct IP address and confirm the entry with the enter key.
- If the problem persists, rectify the error (see Section 1.8.2, page 96).

3. If required, select the desired language in the upper area of the login page.

4. Log in either as **User** or as **Installer** with the respective system password of the user group.

- When logging in for the first time, log in as User or Installer with the respective default system password of the user group:

User group	Default system password
User	0000
Installer	1111

- If you have not yet changed the default system password of your user group, you should change the default system password of both user groups as quickly as possible to prevent unauthorized access to the user interface of the Cluster Controller and the inverters in your system (see Section 1.5.2, page 79).
- If you have already changed the default system password of your user group, log in with the changed system password.

The user interface opens.

The user interface does not open?

Error cause: You have not entered the system password of the selected user group correctly.

- On the login page, enter the correct system password for the selected user group and confirm the entry with the enter key.

Logging Out of the Cluster Controller

Protect your system against unauthorized access by directly logging out of the Cluster Controller user interface. If you simply close your web browser, you will not be logged out of the Cluster Controller until ten minutes have passed.

Procedure:

- Select [**Logout**] in the toolbar.

6 System Settings

6.1 Display Settings

6.1.1 Setting the Display Language

Available display languages

The display languages of the Cluster Controller are German and English. The default language is English.

Procedure:

1. Call up the login page of the Cluster Controller in the web browser.
2. Select the desired language in the upper area of the login page.
3. Log in either as **User** or as **Installer** with the respective system password of the user group. This implements the language change on the user interface and on the display of the Cluster Controller.
- The display language and the user interface language of the Cluster Controller are changed. If you have selected a language other than German via the user interface, the display language will be English.

6.1.2 Adjusting the Display Contrast

1. Call up the display view **Settings**. To do this, simultaneously press and hold the [OK] and [ESC] buttons on the keypad for two seconds.
 - The display view **Settings** opens.
2. Select the line **Display Contrast** and use the arrow buttons to adjust the desired display contrast:

Arrow button	Explanation
▶	Increases the display contrast
◀	Reduces the display contrast

3. To exit the display view **Settings**, press [ESC].

6.2 Setting the User Interface Language

1. Select the Cluster Controller in the system tree and select the menu **Settings** in the device menu.
2. Select the parameter group **Device > Country settings**.
3. Select [Edit].
4. In the drop-down list **Language**, select the desired language. This changes the display language to English if you choose a user interface language other than German.
5. Select [Save].

6.3 Setting the Date Format

i No effect on data exports

The changes to the format only affect the display on the user interface and the Cluster Controller display. The format change has no effect on data exports.

Procedure:

1. Select the Cluster Controller in the system tree and select the menu **Settings** in the device menu.
2. Select the parameter group **Device > Country settings**.
3. Select **[Edit]**.
4. In the drop-down list **Date format**, select the desired date format.

Abbreviation	Explanation
DD	Day
MM	Month
YYYY	Year

5. Select **[Save]**.

6.4 Setting the Number Format

i No effect on data exports

The changes to the format only affect the display on the user interface and the Cluster Controller display. The format change has no effect on data exports.

Procedure:

1. Select the Cluster Controller in the system tree and select the menu **Settings** in the device menu.
2. Select the parameter group **Device > Country settings**.
3. Select **[Edit]**.
4. In the drop-down list **Number format**, select the desired number format.
5. Select **[Save]**.

6.5 Setting the Time Format

i No effect on data exports

The changes to the format only affect the display on the user interface and the Cluster Controller display. The format change has no effect on data exports.

Procedure:

1. Select the Cluster Controller in the system tree and select the menu **Settings** in the device menu.
2. Select the parameter group **Device > Country settings**.
3. Select **[Edit]**.

- In the drop-down list **Time format**, select the desired time format.

Abbreviation	Explanation
HH	24-hour format
hh	12-hour format
mm	Minutes
ss	Seconds

- Select [**Save**].

6.6 Setting the Temperature Unit

- Select the Cluster Controller in the system tree and select the menu **Settings** in the device menu.
- Select the parameter group **Device > Country settings**.
- Select [**Edit**].
- In the drop-down list **Unit of temperature**, select the desired unit of temperature.
- Select [**Save**].

6.7 Settings for System Time

6.7.1 Information on System Time

The system time refers to the date and time of a system. The system time is set via the Cluster Controller and transmitted to all inverters in the system.

If additional communication products are added to the system, the new communication products automatically adopt the existing system time.

If you change the system time, the inverters will adopt the new system time immediately. Additional communication products in the system do not adopt the system time for some time, but a maximum of seven hours later.

You can either set the system time manually on the Cluster Controller or have it synchronized via the Internet using a time server.

Potential loss of system data due to changing the system time

Changing the system time can influence previously recorded system data. If you put back the time or the date, for example, the Cluster Controller may overwrite previously recorded system data.

- Only change the system time if it is necessary to do so.

6.7.2 Synchronizing System Time via the Internet

You can synchronize the system time automatically or manually via the Internet. For this purpose, either Sunny Portal or an NTP server acts as the source. You do not need to register in Sunny Portal.

Procedure:

1. Select the Cluster Controller in the system tree and select the menu **Settings** in the device menu.
2. Select the parameter group **Device > Time settings**.
3. Select [**Edit**].
4. If required, use the drop-down list **Standard/daylight saving time conversion on** to set automatic conversion between standard and daylight saving time.
5. If necessary, set the automatic time synchronization using the drop-down list **Automatic time synchronization**.
6. In the drop-down list **Time synchronization source**, select the desired time synchronization source.
7. If an NTP server is to be used as a time synchronization source, enter the name or the IP address of the desired NTP server in the field **NTP server**.
8. In the drop-down list **Time zone**, select the desired time zone.
9. Select [**Save**].
 - For automatic time synchronization, the Cluster Controller synchronizes the date and the time with Sunny Portal or the NTP server once a day at around 9 p.m.
10. To trigger time synchronization manually, select the button [**Execute**] in the field **Trigger time synchronization**.
 - For manual time synchronization, the Cluster Controller synchronizes the date and the time with the time synchronization source. The time synchronization was successful if the time is displayed in the field **Set system time**.
 - The result of the manual time synchronization attempt is logged in the event log (see Section 9.1, page 51).

6.7.3 Manually Setting the System Time

1. Select the Cluster Controller in the system tree and select the menu **Settings** in the device menu.
2. Select the parameter group **Device > Time settings**.
3. Select [**Edit**].
4. If required, use the drop-down list **Standard/daylight saving time conversion on** to set automatic conversion between standard and daylight saving time.
5. In the field **Set system time**, set the current date and time of the system.
6. In the drop-down list **Time zone**, select the desired time zone.
7. Select [**Save**].

7 Device Configuration

7.1 Setting the Characteristic Curve of the Irradiation Sensor

If you have connected an irradiation sensor to the Cluster Controller, you must also set the characteristic curve of the irradiation sensor via the user interface of the Cluster Controller. As a result, the current signals in mA provided by the irradiation sensor are converted by the Cluster Controller into the proportional irradiation values in W/m^2 and displayed.

Requirement:

- An irradiation sensor must be connected to the Cluster Controller (see the Cluster Controller installation manual).

Procedure:

1. Select the Cluster Controller in the system tree and select the menu **Settings** in the device menu.
2. Select the parameter group **Meteorology > Environment > Irradiation sensor > Characteristic curve**.
3. Select **[Edit]**.
4. Set the characteristic curve depending on the connected irradiation sensor (see manual from manufacturer).
5. Select **[Save]**.

7.2 Parameter Settings

7.2.1 Setting Parameters for a Device Class

A device class refers to all devices of the same type. You can configure all the devices in a device class simultaneously. However, it is not possible to configure different device classes at the same time. Therefore, save the changes made to one device class before processing another device class.

The parameters that you are able to set for a device class depend on the rights of your user group (see Section 4.1, page 22).

Procedure:

1. Select the system in the system tree and select the menu **Settings** in the device menu.
2. Select the parameter group that contains the parameter which is to be configured.
 - The individual device classes are displayed in brackets after the name of the parameter group, e.g. **Device (Communication products)**. It may take a moment for all the data to be read out from the devices.
3. Select **[Edit]** in the parameter group of the desired device class.

4. Set the desired parameters.
 5. Select [**Save**].
- The settings are saved in the Cluster Controller and are then transmitted to all devices of the affected device class. The save process is displayed on the user interface of the Cluster Controller via an hourglass symbol and may take several hours if the DC input voltage in the inverter is too low (e.g. at night).

7.2.2 Setting the Parameters of an Individual Device

The parameters that you are able to set for a device depend on the rights of your user group (see Section 4.1, page 22).

Procedure:

1. Select the desired device in the system tree and select the menu **Settings** in the device menu.
 2. Select the parameter group that contains the parameter which is to be configured. Note that it may take a moment to read off the values since they are retrieved directly from the device.
 3. Select [**Edit**].
 4. Set the desired parameter.
 5. Select [**Save**].
- The settings are saved in the Cluster Controller and are then transmitted to the affected device. The save process is displayed on the user interface of the Cluster Controller via an hourglass symbol and may take several hours if the DC input voltage in the inverter is too low (e.g. at night).

7.3 Deactivating the Webconnect Function of the Inverters

If the Webconnect function is activated for the inverters in the system, you should deactivate the Webconnect function of the inverters to avoid unnecessary attempts by the inverters to connect with Sunny Portal. The Webconnect function of the inverters is activated by default.

You have the following options:

- Disabling the Webconnect function for multiple inverters simultaneously
- Disabling the Webconnect function for an individual inverter

Disabling the Webconnect Function for Multiple Inverters Simultaneously

1. Select the system in the system tree and select the menu **Settings** in the device menu.
 - The individual device classes are displayed in brackets after the name of the parameter group, e.g. **Device (Communication products)**. It may take a moment for all the data to be read out from the devices.
2. Select the parameter group **External communication > Webconnect**.
3. Select [**Edit**].

4. In the drop-down list **Activated**, select the entry **No**.
 5. Select [**Save**].
- The settings are saved in the Cluster Controller and are then transmitted to all devices of the affected device class. The save process is displayed on the user interface of the Cluster Controller via an hourglass symbol and may take several hours if the DC input voltage in the inverter is too low (e.g. at night).

Disabling the Webconnect Function for an Individual Inverter

1. In the system tree, select the desired inverter and select the menu **Settings** in the device menu.
2. Select the parameter group **External communication > Webconnect**.
3. Select [**Edit**].
4. In the drop-down list **Activated**, select the entry **No**.
5. Select [**Save**].

7.4 Saving and Restoring the Device Configuration of the Cluster Controller

Saving the device configuration

1. Select the Cluster Controller in the system tree and select the menu **Update and save** in the device menu.
 2. Select the parameter group **Device configuration** and select [**Save device configuration**].
 3. If required, change the saving location and the file name for the save file.
 4. Select [**Save**].
- The device configuration is downloaded and saved.

Restoring the device configuration

Note the firmware version of the configuration file

Only configuration files with a firmware version that is the same as or older than that of the Cluster Controller can be used to restore the device configuration.

Procedure:

1. Log into the Cluster Controller as **Installer**.
2. Select the Cluster Controller in the system tree and select the menu **Update and save** in the device menu.
3. Select the parameter group **Device configuration** and select [**Browse...**] in the field **Restore device configuration (*.bak)**.
 - The file selection window opens.

4. Select the desired configuration file and select [**Open**].
 - The file name of the selected configuration file is displayed in the field **Restore device configuration (*.bak)**.
5. Select [**Execute**].
 - The configuration file is uploaded and the device configuration is restored. The Cluster Controller restarts.

8 Exporting System Data

8.1 Export Options

The instantaneous values and the parameters of the devices in the system can be saved, displayed and prepared for further processing by the Cluster Controller. The system data can be saved to the internal memory of the Cluster Controller and to an external storage medium. The storage capacity of the internal memory is limited. If the free storage capacity of the internal memory is 10% or below, the older system data will be deleted until a free storage capacity of 20% is reached. Therefore, save the system data to an external storage medium at regular intervals. You have the following options for exporting the system data:

Option	Explanation
Export to USB data carrier	The system data is exported to a USB data carrier that is connected to the Cluster Controller (see Section 8.4, page 47).
Export to integrated FTP server	The system data is exported to the FTP server integrated in the Cluster Controller (see Section 8.5, page 48). You can access the exported system data directly via the integrated FTP server. The integrated FTP server is protected via the system password of the respective user group.
Export to external FTP server	The system data is exported to an external FTP server via FTP push function (see Section 8.6, page 49).
Export to Sunny Portal	The system data is sent to the Sunny Portal Internet portal at a configurable time interval (see Section 11.2, page 57).

8.2 Export Formats

8.2.1 CSV Format

If the CSV format is selected, the Cluster Controller creates a CSV file for each day and saves the collected system data to this file every five minutes. Individual data records are always separated by a semicolon in the CSV file. The decimal separator and the time format within the CSV file depend on the country settings of the Cluster Controller (see Section 6.3, page 37).

Directory path and structure of the file name

Directory path: .../CSV/[YYYY]/[MM]/

File name structure: [YYYYMMDD].csv

Example: daily report file from 2012-10-15

.../CSV/2012/10/20121015.csv

File structure (example)

Line	Explanation
1	CSV file metadata

Line	Explanation	
2	Empty line	
3		Name of device (serial number or changed device name)
4		Device type
5		Serial number of the device
6		Name of the values
7		Type of the values
8	Date and time format	Value unit
9	Time (= date and time) when the device generated the value.	Value
10

8.2.2 XML Format

If the XML format is selected, the Cluster Controller creates a directory for each day and saves the collected system data to this directory every five minutes as XML files. Every 15 minutes, the XML files are packaged to a ZIP file containing three XML files.

Directory path and structure of the file name

Directory path: .../XML/[YYYY]/[MM]/[YYYYMMDD]/

Structure of the file name for an individual XML file: [HHMMSS].xml

Structure of the file name for a ZIP file: [HHMMSS].zip

Example: daily report file from 2012-10-15, 09:48:02 a.m.

.../XML/2012/10/20121015/094802.xml

File structure (example)

```
<?xml version="1.0" encoding="utf-8"?>
<ClusterController>
  <Info>
    <Created>2012-02-10T01:37:04</Created>
    <Culture>de</Culture>
    <UtcOffset>60</UtcOffset>
    <DST>True</DST>
  </Info>
  <MeanPublic>
    <Key>Cluster Controller 1:155000234:Metering.TotWhOut</Key>
    <Mean>761.858</Mean>
    <Base>1</Base>
    <Period>300</Period>
    <Timestamp>2012-02-09T10:55:52</Timestamp>
  </MeanPublic>
  <MeanPublic>
    (...)
  </MeanPublic>
</ClusterController>
```

Designation	Explanation
Info	Information
Created	Date of creation
Culture	Language
UtcOffset	Offset in minutes to UTC
DST	Daylight saving time/standard time adjustment
MeanPublic	Data of the mean values
CurrentPublic	Data of the instantaneous values
Key	Name of the element, made up of device name, serial number of the device and the parameter name Individual values are separated by a colon. Example: D <Key>SENS0700:5141:TpmMdul C</Key>
Min	Minimum value in the measurement interval, calculated by all devices connected to the Cluster Controller
Max	Maximum value in the measurement interval, calculated by all devices connected to the Cluster Controller
Mean	Mean value in the measurement interval, calculated by all devices connected to the Cluster Controller
Base	Number of measured values in the interval/number of calculated values

Designation	Explanation
Period	Length of the measurement interval in seconds
TimeStamp	Time stamp at which the average was calculated

8.3 Setting the Measured Value Name

You can have the measured values displayed as follows:

- Technical name of the measured values; example: **Metering.TotWhOut**
- Name of the measured values as a term; example: **Total yield**

Procedure:

1. Select the Cluster Controller in the system tree and select the menu **Settings** in the device menu.
2. Select the parameter group **Data logging > Export**.
3. Select [**Edit**].
4. Set the measured value name:
 - In the drop-down list **Measured value name in local language**, select **Yes** in order to display the measured values as a term.
 - In the drop-down list **Measured value name in local language**, select **No** in order to display the technical name of the measured values.
5. Select [**Save**].

8.4 Exporting System Data to a USB Data Carrier

Depending on the available storage capacity of the USB data carrier and the configuration of your system, the following approximate archival periods for the system data are possible:

Number of connected inverters	Approximate archival period	
	4 GB storage capacity	8 GB storage capacity
5	10 years	20 years
10	5 years	10 years
25	2 years	4 years
50	1 year	2 years
75	9 months	18 months

Requirements:

- Maximum storage capacity: 2 TB
- The USB data carrier must be formatted in the file system FAT16 or FAT32.

Procedure:

- Connect the USB data carrier to the Cluster Controller at USB port 1.
 - Depending on the available storage capacity of the USB data carrier, the Cluster Controller exports the system data to the USB data carrier in the selected export format (see Section 8.1, page 44).

8.5 Exporting System Data to the Integrated FTP Server

8.5.1 Setting the Export Format for System Data

1. Select the Cluster Controller in the system tree and select the menu **Settings** in the device menu.
2. Select the parameter group **Data logging > Export**.
3. Select [**Edit**].
4. Select the export format for the system data:
 - To export the system data in CSV format, select the entry **Yes** in the drop-down list **Data export in CSV format** (default setting).
 - To export the system data in XML format, select the entry **Yes** in the drop-down list **Data export in XML format**.
5. Select [**Save**].

8.5.2 Activating or Deactivating the Integrated FTP Server

1. Select the Cluster Controller in the system tree and select the menu **Settings** in the device menu.
2. Select the parameter group **Device > FTP server**.
3. Select [**Edit**].
4. Make the setting for the integrated FTP server:
 - To activate the integrated FTP server, select the entry **Yes** in the drop-down list **Activated**.
 - To deactivate the integrated FTP server, select the entry **No** in the drop-down list **Activated** (default setting).
5. Select [**Save**].

8.5.3 Accessing the Integrated FTP Server via the Web Browser

Requirement:

- The integrated FTP server must be activated (see Section 8.5.2, page 48).

Example: Entering the IP address, user ID and system password

If you wish to use the password "1111" to log into the Cluster Controller as an installer with the IP address 192.169.4.2, enter the following:

```
ftp://installer:1111@192.169.4.2
```

Procedure:

1. The IP address of the Cluster Controller, the user ID and the system password are to be entered in the address bar of the web browser as follows:

ftp://[UserID]:[Password]@[IP-address]

Use the following user ID:

User ID	Explanation
Installer	User ID for the user group Installer
User	User ID for the user group User

2. Press the enter key.
 - The web browser displays the directory structure of the integrated FTP server. You can now display the saved data or download the desired data.
3. Delete the web browser cache. This removes your login data from the cache and prevents unauthorized access to the integrated FTP server.

8.6 Additionally Exporting System Data to an External FTP Server (FTP Push)

8.6.1 Activating or Deactivating the FTP Push Function

Activating the FTP Push Function

Via the FTP push function, the Cluster Controller can upload the collected system data to any arbitrary external FTP server. For FTP Push, port 21 is set by default. The collected system data is uploaded to the given directory and in the selected data format every 15 minutes.

Requirements:

- Port 21 must be approved in the router firewall settings.
- In the FTP server, the "Append" function must be activated. New data is appended to a file already on the FTP server and the data volume to be transferred is reduced.

Procedure:

1. Select the Cluster Controller in the system tree and select the menu **Settings** in the device menu.
2. Select the parameter group **Further Applications > FTP Push**.
3. Select **[Edit]**.
4. Select the export format for the system data:
 - To export the data in CSV format, select **Yes** in the field **Data export in CSV format**.
 - To export the data in XML format, select **Yes** in the field **Data export in XML format**.
5. In the field **Login**, enter the login name of the external FTP server.
6. In the field **Port**, enter the network port of the external FTP server.
7. In the field **Password**, enter the password of the external FTP server.

8. In the field **Server path**, enter the subdirectory to which the Cluster Controller is to save the data on the external FTP server.
 9. In the field **Server**, enter the name or the IP address of the external FTP server.
 10. Select [**Save**].
 11. Perform a connection test. Select [**Execute**] in the field **Connection test**.
- The Cluster Controller performs the connection test. **OK** is displayed in the field **Result of the last connection test**.
 - The connection test has failed?
 - Rectify the error (see Section 18.2, page 96).

Deactivating the FTP Push Function

1. Select the Cluster Controller in the system tree and select the menu **Settings** in the device menu.
2. Select the parameter group **Further Applications > FTP Push**.
3. Select [**Edit**].
4. Deactivate the export of system data:
 - In the field **Data export in CSV format**, select the entry **No**.
 - In the field **Data export in XML format**, select the entry **No**.
5. Select [**Save**].

8.6.2 Testing the FTP Push Function



1. Select the Cluster Controller in the system tree and select the menu **Settings** in the device menu.
 2. Select the parameter group **Further Applications > FTP Push**.
 3. In the field **Connection test**, select [**Execute**].
- The Cluster Controller performs the connection test. **OK** is displayed in the field **Result of the last connection test**.
 - The connection test has failed?
 - Rectify the error (see Section 18.2, page 96).

9 System Monitoring

9.1 Displaying Events

You can have an event log displayed for each device in the system. All events for the device are logged in the event log (for information on the event types in the menu **Events**, see Section 4.2.4.6, page 31). Up to 500 events are displayed.

Procedure:

1. To display events for a device, select the desired device in the system tree and select the menu **Events** in the device menu.
2. For events with the wrench symbol () , contact the user with **Installer** rights and inform them of the serial number of the device and the event number.
3. For events with the telephone receiver symbol () , contact the user with the **Installer** rights and inform them of the serial number of the device and the event number. The user with **Installer** rights contacts the Service.

9.2 Setting Alarms

You can use the alarm function to be informed via e-mail of alarm-related events in the system. The Cluster Controller takes into account the events of the last 24 hours. Alarm-related events include **Fault** type events that can lead to yield loss.

Procedure:

1. Log into the Cluster Controller as **Installer**.
2. Select the Cluster Controller in the system tree and select the menu **Settings** in the device menu.
3. Make the settings for the SMTP server:
 - Select the parameter group **External communication > SMTP**.
 - Select **[Edit]**.
 - In the drop-down list **Encryption**, select the desired password encryption type.
 - In the field **Login**, enter the login name for the SMTP server.
 - If required, enter an alternative e-mail address in the field **Alternative e-mail sender address (optional)** that is to be displayed in the e-mail as the sender. If you do not enter an alternative e-mail address, the e-mail address in the field **Login** is displayed as the e-mail sender address.
 - In the field **Port**, enter the network port at which the SMTP server can be accessed. Tip: The normal ports for SMTP servers are ports 25, 465 and 587. When using port 465, an encrypted connection is always established regardless of the selected encryption type.
 - In the field **Password**, enter the password for the SMTP server.
 - In the field **Server**, enter the name or the IP address of the SMTP server.
 - Select **[Save]**.
4. Make the settings for e-mail alarms:
 - Select the parameter group **Further Applications > Alarm > E-mail**.

- Select **[Edit]**.
 - In the field **Activated**, select the entry **Yes**.
 - If the e-mail is to be displayed in a language other than the currently configured language, select the desired e-mail language in the drop-down list **Language**.
 - In the field **E-mail address(es)**, enter the recipient's e-mail address. If more than one e-mail address is to be entered, separate each of the e-mail addresses with a comma or a semicolon.
5. If required, set a filter for the alarm:
- Select the group **Filter settings**.
 - If there is to be no alarm for reactive power setpoint events, select the entry **No** in the drop-down list **Alarm at reactive power setpoint**.
 - If there is to be no alarm for active power limitation events, select the entry **No** in the drop-down list **Alarm at active power limitation**.
6. Select **[Save]**.
7. Test the alarm via e-mail:
- Select the group **E-mail**.
 - In the field **Send test e-mail**, select **[Execute]**.
- The Cluster Controller sends a test e-mail to the given e-mail address. **OK** is displayed in the field **Result of the last e-mail dispatch**.
- The test e-mail could not be sent?
- Possible error cause: You have entered the e-mail address incorrectly, there is no Internet connection or the Cluster Controller network settings are faulty.
- Correct the e-mail address entered.
 - Establish an Internet connection.
 - Ensure that the SMTP settings of the Cluster Controller are correct.
 - If there is a proxy server in your LAN, ensure that the proxy settings of the Cluster Controller are correct.
- You did not receive the test e-mail?
- Check the spam folder of your e-mail inbox.
 - Check the local network settings and adjust if required.

10 System Management and Replacing Components

10.1 Changing System Names or Device Names

1. Select the Cluster Controller in the system tree and select the menu **Settings** in the device menu.
2. Select the parameter group **Type label > Type label**.
3. Select [**Edit**].
4. To change the system name, enter the desired name in the field **System name**.
5. To change the device name, enter the desired name in the field **Device name**.
6. Select [**Save**].

10.2 Use of SMA Energy Meters in the System

Currently, the Cluster Controller supports a maximum of one Energy Meter. The Energy Meter must be used as the measuring device for the active power feed-in at the grid-connection point. The Cluster Controller automatically detects the Energy Meter. If there is more than one Energy Meter in your system, make sure that the automatically detected Energy Meter is the Energy Meter installed as the measuring device at the grid-connection point. You will require the serial number of the Energy Meter. Note: The serial number can be found on the type label of the Energy Meter.

Procedure:

1. Select the Cluster Controller in the system tree and select the menu **Settings** in the device menu.
 2. Select the parameter group **system communication > Measured values > Meter on Speedwire**.
 3. Select [**Edit**].
 4. Check whether the serial number of the Energy Meter installed at the grid-connection point is displayed in the field **Serial Number**. If the correct serial number is not displayed, delete the serial number shown and enter the serial number of the required Energy Meter instead.
 5. Select [**Save**].
- The desired Energy Meter is now used as the Speedwire meter. The meter reading of the previously used Energy Meter is adopted.

10.3 Reading Off the Type, Serial Number and Firmware Version of the Devices

1. Select the device in the system tree and select the menu **Settings** in the device menu. Tip: The serial number and the firmware version of the Cluster Controller are also displayed at the bottom left in the status bar.
2. To read off the serial number of the device, select the parameter group **Type label > Type label**.

3. To read off the firmware version of the integrated communication interface (e.g. SMA Speedwire/Webconnect data module), select the parameter group **Type label > Type label**. Here, the firmware version of the communication interface is displayed in the field **Software package**.
4. To read off the firmware version of the inverter, select the parameter group **Device components > Type label > Central assembly**. Here, the firmware version is displayed in the field **Software version**.

10.4 IP Addresses of the Devices

10.4.1 Reading Off the IP Address of the Cluster Controller

You have two options for reading off the IP address of the Cluster Controller:

- Reading off the IP address from the display
- Reading off the IP address from the user interface

Reading off the IP address from the display

- On the Cluster Controller, select the display view **External communication** and read off the IP address.

Reading off the IP address from the user interface

1. Select the Cluster Controller in the system tree and select the menu **Settings** in the device menu.
2. Select the parameter group **External communication** and read off the IP address:
 - If the Cluster Controller automatically receives its IP address via DHCP, read off the IP address in the group **DHCP**.
 - If the Cluster Controller has received a static IP address, read off the IP address in the group **Ethernet**.

10.4.2 Reading Off the IP Address of the Inverter

You have two options for reading off the IP address of the inverter:

- Reading off the IP address from the inverter display
- Reading off the IP address from the user interface of the Cluster Controller

Reading off the IP address from the inverter display

- Tap twice on the enclosure lid.
 - The display alternates automatically between the firmware version, the serial number of the inverter, the NetID, IP address, subnet mask, the configured country data set, and the display language.

Reading off the IP address from the user interface of the Cluster Controller

1. In the system tree, select the desired inverter and select the menu **Instantaneous values** in the device menu.
2. Select the parameter group **System communication > Speedwire** and read off the IP address.

10.5 Adding an Inverter

1. Connect the new inverter to the Cluster Controller (see the Cluster Controller installation manual).
2. Log into the Cluster Controller as **Installer**.
 - The new inverter is displayed with a padlock symbol in the system tree.
3. Adjust the device password of the inverter marked with the padlock symbol to the system password (see Section 1.5.3, page 80).
4. If you are using Sunny Portal, activate the inverter in Sunny Portal (see the user manual of the Cluster Controller in Sunny Portal).

10.6 Replacing the Cluster Controller or an Inverter

For information on replacing the Cluster Controller or an inverter in the Cluster Controller system, see the Installation Manual ""Replacement of SMA Devices in Systems with Communication Products"" at www.SMA-Solar.com.

11 Sunny Portal

11.1 Registering the Cluster Controller in Sunny Portal

i No combination of Cluster Controller and Sunny WebBox in one Sunny Portal system

In a Sunny Portal system, the Cluster Controller must not be used in combination with the Sunny WebBox.

- If there is already a Sunny WebBox in the Sunny Portal system where you want to integrate the Cluster Controller, delete the Sunny WebBox from the Sunny Portal system before registering the Cluster Controller (see user manual of the Cluster Controller in Sunny Portal).

Procedure:

1. Select the Cluster Controller in the system tree and select the menu **Settings** in the device menu.
2. If there is a proxy server in your LAN, make the proxy settings on the user interface of the Cluster Controller (see Section 17.2, page 87). This ensures that the Cluster Controller can establish a connection to Sunny Portal via the proxy server.
3. Select the parameter group **Sunny Portal > Basic settings**.
4. Select **[Edit]**.
5. Activate data transmission to Sunny Portal. Select the entry **Yes** in the drop-down list **Use Sunny Portal**.
6. Make the user settings in the group **User settings**:
 - In the field **E-mail**, enter the e-mail address to which Sunny Portal is to send the access data.
 - The system identifier is automatically entered in the field **ID of PV system**. Together with the e-mail address and the system name, the system identifier is a unique identifier of the system in Sunny Portal.
 - In the field **PV system name**, enter the name under which the system is to be displayed in Sunny Portal.
7. Select **[Save]**.
8. Perform the registration in Sunny Portal. Select **[Execute]** in the field **Register** in the group **Status and Actions**.
 - The Cluster Controller synchronizes the system time with Sunny Portal and carries out the registration. **OK** is displayed in the field **Result of the last registration** and Sunny Portal sends the access data to the specified e-mail address.
 - The registration of the other devices in the system is performed automatically.
 - The result of the registration attempt is logged in the event log (see Section 9.1, page 51).
 - The registration has failed?
 - Rectify the error (see Section 18.2, page 96).

11.2 Setting Data Transmission to Sunny Portal

Requirement:

- You must already be registered in Sunny Portal (see Section 11.1, page 56).

Procedure:

1. Select the Cluster Controller in the system tree and select the menu **Settings** in the device menu.
2. Select the parameter group **Sunny Portal > Basic settings**.
3. Select **[Edit]**.
4. Select the desired entry in the drop-down list **Use Sunny Portal**:

Entry	Explanation
Yes	Activates data transmission to Sunny Portal
No	Deactivates data transmission to Sunny Portal

5. Select **[Save]**.

11.3 Setting Communication Monitoring

For communication monitoring, the Cluster Controller sends a signal to Sunny Portal at a configurable time interval. If the signal fails to arrive, Sunny Portal alerts you via e-mail depending on the strictness of the communication monitoring configured in Sunny Portal (see the user manual of the Cluster Controller in Sunny Portal).

Example: Setting communication monitoring

The time interval **every 8 hours** is selected in the Cluster Controller for sending the communication monitoring signal, and the communication monitoring setting **Sharp** is selected in Sunny Portal. If Sunny Portal has not received a signal from the Cluster Controller after eight hours and 15 minutes, Sunny Portal sends an e-mail alarm. After the alarm e-mail, Sunny Portal sends a reminder e-mail up to three days later stating that the communication error is still present.

Failed send attempts are logged in the event log

If the send attempt fails (e.g. if Sunny Portal is not available or in the event of network problems), the Cluster Controller logs this in the event log (see Section 9.1, page 51).

Requirement:

- You must already be registered in Sunny Portal (see Section 11.1, page 56).

Procedure:

1. Select the Cluster Controller in the system tree and select the menu **Settings** in the device menu.
2. Select the parameter group **Sunny Portal > Basic settings**.
3. Select **[Edit]**.
4. In the drop-down list **Communication monitoring signal**, select the desired time interval (default setting: **every 8 hours**).

5. Select [**Save**].
6. Adjust the strictness of communication monitoring in Sunny Portal if required (see the user manual of the Cluster Controller in Sunny Portal).

11.4 Setting the Upload Frequency

i Delay in data upload possible

To prevent excessive data volume for Sunny Portal at specific times, the Cluster Controller delays the start of the data upload by up to ten minutes if required.

If a data upload is still in progress and the Cluster Controller is to start a new data upload (e.g. at a configured time interval of 15 minutes), then the Cluster Controller will not perform the new data upload and instead transmits the data at the next time interval.

Requirement:

- You must already be registered in Sunny Portal (see Section 11.1, page 56).

Procedure:

1. Select the Cluster Controller in the system tree and select the menu **Settings** in the device menu.
2. Select the parameter group **Sunny Portal > Basic settings**.
3. Select [**Edit**].
4. In the drop-down list **Upload frequency**, select the desired time interval.

Time interval	Explanation
Every 15 minutes	Data upload takes place every 15 minutes.
Hourly	Data upload takes place every 60 minutes.
Daily	Data upload takes place daily at around 1:30 a.m.

5. Select [**Save**].

11.5 Testing the Connection to Sunny Portal

1. Select the Cluster Controller in the system tree and select the menu **Settings** in the device menu.
 2. Select the parameter group **Sunny Portal > Status and Actions**.
 3. In the field **Portal connection test**, select [**Execute**].
- The Cluster Controller performs the connection test. **OK** is displayed in the field **Result of the last connection test**.
 - The connection test has failed?
 - Rectify the error (see Section 18.2, page 96).

11.6 Adjusting the System Identifier for Sunny Portal

In the following cases, you must adjust the system identifier for Sunny Portal in the Cluster Controller:

- Another communication device (e.g Sunny WebBox) has already sent system data of the affected system to Sunny Portal.
- You have reset the Cluster Controller to the default settings.
- You have replaced the Cluster Controller with another Cluster Controller.

Procedure:

1. Log into Sunny Portal using the available access data (see the user manual of the Cluster Controller in Sunny Portal).
2. If there is already a Sunny WebBox in the Sunny Portal system where you wish to integrate the Cluster Controller, delete the Sunny WebBox from the Sunny Portal system (see user manual of the Cluster Controller in Sunny Portal).
3. In Sunny Portal, copy the system identifier:
 - Select **Configuration > System properties**.
 - Select the tab **System data**.
 - Select **[Edit]**.
 - Copy the system identifier to the clipboard.
4. Log into the Cluster Controller.
5. Select the Cluster Controller in the system tree and select the menu **Settings** in the device menu.
6. Select the parameter group **Sunny Portal > User settings**.
7. Select **[Edit]**.
8. In the field **System identifier**, delete the current content and insert the content of the clipboard.
9. Select **[Save]**.

12 Modbus Configuration

12.1 Activating the Modbus Server

When using a Modbus client, you must activate the required Modbus server via the user interface of the Cluster Controller.

Procedure:

1. Log into the Cluster Controller as **Installer**.
2. Select the Cluster Controller in the system tree and select the menu **Settings** in the device menu.
3. Select the parameter group **External communication > Modbus**.
4. Select [**Edit**].
5. To use the TCP server, make the following settings in the group **TCP server**:
 - In the drop-down list **Activated**, select the entry **Yes**.
 - If necessary, change the port in the field **Port** (default setting: 502).
6. To use the UDP server, make the following settings in the group **UDP server**:
 - In the drop-down list **Activated**, select the entry **Yes**.
 - If necessary, change the port in the field **Port** (default setting: 502).
7. Select [**Save**].
8. If required, make additional Modbus settings (see the Technical Description "SMA CLUSTER CONTROLLER Modbus® Interface").

12.2 Saving or Updating the Modbus Profile and System Configuration

Saving the Modbus Profile

1. Select the Cluster Controller in the system tree and select the menu **Update and save** in the device menu.
2. Select the parameter group **Modbus**.
3. Select [**Save user-defined Modbus profile (usrprofile.xml)**] and save the file to the desired storage location with the desired file name.

Updating the Modbus Profile

1. Log into the Cluster Controller as **Installer**.
2. Select the Cluster Controller in the system tree and select the menu **Update and save** in the device menu.
3. Select the parameter group **Modbus**.
4. To update the SMA Modbus profile, perform the following steps:
 - In the field **Update SMA Modbus profile (*.xml)**, select [**Browse...**].
 - The file selection window opens.

- Select the desired SMA Modbus profile and select [**Open**].
 - The file name of the SMA Modbus profile is displayed in the field **Update SMA Modbus profile (*.xml)**.
 - Select [**Refresh**].
5. To update the user-defined Modbus profile, perform the following steps:
- In the field **Update user-defined Modbus profile (*.xml)**, select [**Browse...**].
 - The file selection window opens.
 - Select the desired Modbus profile and select [**Open**].
 - The file name of the user-defined Modbus profile is displayed in the field **Update user-defined Modbus profile (*.xml)**.
 - Select [**Refresh**].

Saving the System Configuration

1. Select the Cluster Controller in the system tree and select the menu **Update and save** in the device menu.
2. Select the parameter group **Modbus**.
3. To save the automatically created system configuration, select [**Save automatically generated system configuration (sysplant.xml)**].
4. To save the user-defined system configuration file, select [**Save user-defined system configuration (usrplant.xml)**].

Updating the System Configuration

1. Log into the Cluster Controller as **Installer**.
2. Select the Cluster Controller in the system tree and select the menu **Update and save** in the device menu.
3. Select the parameter group **Modbus**.
4. In the field **Update user-defined system configuration (*.xml)**, select [**Browse...**].
 - The file selection window opens.
5. Select the desired system configuration file and select [**Open**].
 - The file name of the system configuration file is displayed in the field **Update user-defined system configuration (*.xml)**.
6. Select [**Update**].

13 Grid Management Services

13.1 Options for Implementing Grid Management Service Setpoints

You can have the Cluster Controller implement the grid management service setpoints by using open-loop or closed-loop control.

In the event that the Cluster Controller evaluates a setpoint as invalid or does not receive a setpoint within a configurable interval, you can make additional settings for the fallback (see Section 13.5, page 70).

The setpoint for active power limitation is specified in percent. The total system power is taken as the reference value. By default, the system inverter power determined by the Cluster Controller is set as the value for the total system power. If necessary, you can adjust the value when configuring the active power limitation.

Open-loop control

For Cluster Controller systems without self-consumption and with direct limitation of active power feed-in, the operating mode **Open-loop control** is used. In this operating mode, the Cluster Controller can receive the grid management service setpoints from three different types of signal source. The different signal sources can be combined:

Type of setpoint signal	Explanation
Digital signals	The setpoints are transmitted to the Cluster Controller as digital signals in the form of binary values. Up to four relay contacts can be used for the active power limitation and the reactive power setpoint.
Analog signals	The setpoints are transmitted to the Cluster Controller as analog current signals. Current signals from 0 mA to 20 mA can be transmitted for the active power limitation and the reactive power setpoint.
Setpoint signal via Modbus client	The setpoints are transmitted via a Modbus client to the network port X13 or X14 on the Cluster Controller (for information on Modbus configuration, see Section 12, page 60).

Closed-loop control

For Cluster Controller systems with self-consumption, the operating mode **Closed-loop control** is used. In this operating mode, you can regulate the active power fed in by the system at the grid-connection point and limit it e.g. to a fixed percentage value. In addition to the total system power, the Cluster Controller needs the measured actual value of the active power fed in at the grid-connection point.

13.2 Setting Parameters for Grid Management Services in the Inverters

To enable the inverters in the system to implement the grid management service setpoints of the Cluster Controller, you will first need to set the corresponding parameters in the inverters.

Requirement:

- You must have received a personal SMA Grid Guard code (application form for the SMA Grid Guard code available at www.SMA-Solar.com, for further information on the SMA Grid Guard code, see Section 15.5, page 83).

Procedure:

1. Log in to the Cluster Controller as **Installer**.
2. Select the SMA Grid Guard symbol () in the status bar.
 - This opens the SMA Grid Guard dialog.
3. In the field **Individual access code**, enter the personal SMA Grid Guard code.
4. Select **[OK]**.
 - The SMA Grid Guard mode is activated. In the system tree, updating the symbols for access rights (SMA Grid Guard symbol and padlock symbol) can take up to two minutes.
5. Select the system in the system tree and select the menu **Settings** in the device menu.
6. Select the parameter group **System & device control**.
7. Select **[Edit]**.
8. To enable the inverters to receive and implement setpoints for active power limitation from the Cluster Controller, proceed as follows:
 - Select the group **Configuration of feed-in management**.
 - In the dropdown list **Operating mode Active power**, select **Act. power lim. via PV system ctrl.**
9. To enable the inverters to receive and implement setpoints for reactive power from the Cluster Controller, proceed as follows:
 - Select the group **Conf. of the static voltage maint. at Q on demand**.
 - Select the desired entry in the dropdown list **Operating mode of static voltage stabilisation**.

Setting	Explanation
cosPhi, specified by PV system control	The inverter only implements cos Phi setpoints.
Q specified by PV system control	The inverter only implements Reactive power in % setpoints.
cos Phi or Q specification through optimum PV system control	The inverter implements cos Phi setpoints as well as Reactive power in percent setpoints.

10. Select **[Save]**.

13.3 Settings for Active Power Limitation

13.3.1 Controlling Active Power Limitation

i Input signals up to 21 mA possible

For an analog signal source, the Cluster Controller classifies input signals as valid up to a maximum of 21 mA. This enables intentional overload to ensure that the maximum setpoint is reached.

Requirements:

- The configuration for the active power limitation must be agreed upon with the responsible grid operator.
- The necessary parameter for the active power limitation must be set in the inverter (see Section 13.2, page 63).

Procedure:

1. Log into the Cluster Controller as **Installer**.
2. In the system tree, select the Cluster Controller and select the menu **Grid management services** in the device menu.
3. Make the general settings:
 - Select the parameter group **General settings > System control**.
 - Select **[Edit]**.
 - In the drop-down list **Operating mode**, select the entry **Open-loop control**.
 - If you are using digital or analog inputs, enter the desired time interval in the field **Time interval for the output value**.
 - If necessary, adjust the value for the total system power. By default, the nominal inverter power available in the system is used as the value for total system power.
 - In the drop-down list **Total system power** select the entry **User-defined**.
 - In the field **Save user-defined total system power**, enter the desired value.
4. Select the parameter group **Active power** and select **[Edit]**.
5. Activate the checkboxes for the desired signal sources in the group **Basic settings > Signal source**. Note that the desired Modbus server must be activated in the Cluster Controller when you are using Modbus (see Section 12.1, page 60).
6. When using the digital inputs, make the settings for the digital inputs:
 - Select the group **Settings of digital inputs**.
 - In the field **Failure tolerance time**, enter a value above 1 second if possible. This prevents e.g. a brief, simultaneous activation of two relays of a ripple control receiver during a Cluster Controller status change being classified as an invalid status.
7. When using the analog inputs, make the settings for the analog inputs:
 - Select the group **Settings of analog inputs**.
 - In the field **Failure tolerance time**, enter the desired time interval.
 - In the field **Initial value input signal**, enter the desired value.

- In the field **Final value input signal**, enter the desired value.
 - In the field **Start setpoint active power limitation**, enter the desired value.
 - In the field **End setpoint active power limitation**, enter the desired value.
8. Select the group **Settings for active power control** and select the desired setting in the field **Active power control switched on** in the drop-down list.

Setting	Explanation
Yes	The active power setpoint is implemented gradually in accordance with your additional settings in the group Settings for active power control
No	The active power setpoint is implemented immediately.

9. If you have activated active power control, make the following additional settings:
- In the field **Time interval in the event of a changed setpoint**, enter the desired time interval.

Example: Time interval in the event of a changed setpoint is 60 seconds

Immediately after the setpoint sent by the signal generator is changed, the Cluster Controller sends a control command with a corresponding output value to the inverters. If additional output values are required in order to reach the setpoint, and you have entered a value of 60 seconds for the parameter **Time interval in case of a changed setpoint**, the Cluster Controller sends each of these additional output values at intervals of 60 seconds. Once the modified setpoint has been reached, the Cluster Controller once again sends the current output value at the time interval you entered for the parameter **Time interval for the output value** in the parameter group **General settings**.

- In the field **Max. change in case of power increase**, enter the desired value.
 - In the field **Max. change in case of power reduction**, enter the desired value.
10. When using the digital inputs, set the status configuration:
- Select the group **Status configuration**.
 - Depending on the number of digital inputs used in the column **Active**, activate the selection field of the status to be configured in each case.
 - In the column **Active power**, enter the desired value for the status to be configured in each case.
11. Make the settings for the fallback (see Section 13.5, page 70).

13.3.2 Regulating Active Power Limitation at the Grid-Connection Point

Possibly the grid operator has stipulated closed-loop control of active power feed-in at the grid-connection point for your system. If you are not sure about this, contact your grid operator. If your grid operator requires the system not to feed in any active power, you must limit the active power feed-in to a fixed value of 0% and additionally adjust the preset value for the active power gradient. Thus, it is possible to reduce the active power to 0% within a few seconds.

To regulate active power feed-in at the grid-connection point, perform the following actions in the specified order. The exact procedure is described in the following sections.

- Adjusting the settings for the active power gradient
- Selecting measurement source of active power feed-in at the grid-connection point
- Making settings for active power limitation

Adjusting the Settings for the Active Power Gradient

This setting is only required if the grid operator requires the system not to feed in active power.

Requirement:

- You must have received a personal SMA Grid Guard code (application form for the SMA Grid Guard code available at www.SMA-Solar.com, for further information on the SMA Grid Guard code, see Section 15.5, page 83).

Procedure:

1. Log in to the Cluster Controller as **Installer**.
2. Select the SMA Grid Guard symbol () in the status bar.
 - This opens the SMA Grid Guard dialog.
3. In the field **Individual access code**, enter the personal SMA Grid Guard code.
4. Select [**OK**].
 - The SMA Grid Guard mode is activated. In the system tree, updating the symbols for access rights (SMA Grid Guard symbol and padlock symbol) can take up to two minutes.
5. Select the system in the system tree and select the menu **Settings** in the device menu.
6. Select the parameter group **System & device control**.
7. Select [**Edit**].
8. Select the group **Inverter**.
9. Enter the value **200** in the field **Active power gradient**.
10. Select [**Save**].

Selecting Measurement Source of Active Power Feed-In at the Grid-Connection Point

Requirement:

- A measurement source (e.g., Energy Meter) must be available at the grid-connection point.

Procedure:

1. Log into the Cluster Controller as **Installer**.
2. Select the Cluster Controller in the system tree.
3. Select **Settings** in the device menu.
4. Select the parameter group **Grid connection > Measured values > Measurements at grid-connection point**.
5. Select [**Edit**].

6. In the drop-down list **Source for system active power** select the measurement source used at the grid-connection point. If you are using an Energy Meter as measurement source, make sure that the serial number of the Energy Meter used as the measurement source is displayed under **PV system communication > Measured values > Meter on Speedwire** in the field **Serial Number**. If the correct serial number is not displayed, enter the serial number of the required Energy Meter in the field.
7. Select [**Save**].
8. If you are using one of the analog current inputs of the Cluster Controller as measurement source, configure the characteristic curve of this analog current input. By this means, the current signals measured at the analog current input are converted into the corresponding percentages for active power feed-in:
 - Select the parameter group **Device > Inputs/outputs > Analog input**.
 - Select [**Edit**].
 - Set the characteristic curve depending on the connected sensor (see manual from manufacturer).
 - Select [**Save**].

Making settings for active power limitation

Requirements:

- The configuration for the active power limitation must be agreed upon with the responsible grid operator.
- The necessary parameter for the active power limitation must be set in the inverter (see Section 13.2, page 63).

Procedure:

1. Log into the Cluster Controller as **Installer**.
2. In the system tree, select the Cluster Controller and select the menu **Grid management services** in the device menu.
3. Make the general settings:
 - Select the parameter group **General settings > System control**.
 - Select [**Edit**].
 - In the drop-down list **Operating mode**, select the entry **Closed-loop control**.
 - If you are using digital or analog inputs, enter the desired time interval in the field **Time interval for the output value**.
 - If necessary, adjust the value for the total system power. By default, the nominal inverter power available in the system is used as the value for total system power.
 - In the drop-down list **Total system power** select the entry **User-defined**.
 - In the field **User-defined total system power**, enter the desired value.
 - Select [**Save**].
4. Select the parameter group **Active power** and select [**Edit**].
5. In the group **Basic settings > Signal source** activate the checkbox **Manual specification**.
6. Select the group **Settings for manual specification**.

7. In the field **Active power** enter the desired value for the fixed active power limitation.
8. Make the settings for the fallback (see Section 13.5, page 70).

13.4 Settings for Reactive Power Setpoint

13.4.1 Controlling Reactive Power via the Setpoint "Reactive Power in %"

If you have selected **Reactive power in %** as reactive power setpoint, the reactive power is used as a percentage value based on the maximum possible active power.

Input signals up to 21 mA possible

For an analog signal source, the Cluster Controller classifies input signals as valid up to a maximum of 21 mA. This enables intentional overload to ensure that the maximum setpoint is reached.

Requirements:

- The configuration for the reactive power setpoint must be agreed upon with the responsible grid operator.
- The required parameter for the reactive power setpoint must be configured in the inverter (see Section 13.2, page 63).

Procedure:

1. Log into the Cluster Controller as **Installer**.
2. In the system tree, select the Cluster Controller and select the menu **Grid management services** in the device menu.
3. Make the general settings:
 - Select the parameter group **General settings > System control**.
 - Select **[Edit]**.
 - In the drop-down list **Operating mode**, select the entry **Open-loop control**.
 - If you are using digital or analog inputs, enter the desired time interval in the field **Time interval for the output value**.
4. Select the parameter group **Reactive power** and select **[Edit]**.
5. Make the basic settings in the group **Basic settings**:
 - In the field **Signal source** in the drop-down list, select the desired signal source. Note that the desired Modbus server must be activated in the Cluster Controller when you are using the Modbus (see Section 12.1, page 60).
 - In the drop-down list **Predefined Quantity**, select the setpoint **Reactive power in %**.
6. When using the digital inputs, make the settings for the digital inputs:
 - Select the group **Settings of digital inputs**.
 - In the field **Failure tolerance time**, enter a value above 1 second if possible. This prevents e.g. a brief, simultaneous activation of two relays of a ripple control receiver during a Cluster Controller status change being classified as an invalid status.
7. When using the analog inputs, make the settings for the analog inputs:

- Select the group **Settings of analog inputs**.
 - In the field **Failure tolerance time**, enter the desired time interval.
 - In the field **Initial value input signal**, enter the desired value.
 - In the field **Final value input signal**, enter the desired value.
 - In the field **Start setpoint reactive power**, enter the desired value.
 - In the field **End setpoint reactive power**, enter the desired value.
8. When using the digital inputs, set the status configuration:
- Select the group **Status configuration**.
 - Depending on the number of digital inputs used in the column **Active**, activate the selection field of the status to be configured in each case.
 - In the column **Reactive power**, enter the desired value for the status to be configured in each case.
9. Make the settings for the fallback (see Section 13.5, page 70).

13.4.2 Controlling Reactive Power via the Setpoint "cos Phi"

If you select the displacement power factor $\cos \varphi$ as the reactive power setpoint, the cosine function of the phase shift angle between the current and the voltage is used as setpoint.

Input signals up to 21 mA possible

For an analog signal source, the Cluster Controller classifies input signals as valid up to a maximum of 21 mA. This enables intentional overload to ensure that the maximum setpoint is reached.

Requirements:

- The configuration for the reactive power setpoint must be agreed upon with the responsible grid operator.
- The required parameter for the reactive power setpoint must be configured in the inverter (see Section 13.2, page 63).

Procedure:

1. Log into the Cluster Controller as **Installer**.
2. In the system tree, select the Cluster Controller and select the menu **Grid management services** in the device menu.
3. Make the general settings:
 - Select the parameter group **General settings > System control**.
 - Select **[Edit]**.
 - In the drop-down list **Operating mode**, select the entry **Open-loop control**.
 - If you are using digital or analog inputs, enter the desired time interval in the field **Time interval for the output value**.
4. Select the parameter group **Reactive power** and select **[Edit]**.
5. Make the basic settings in the group **Basic settings**:

- In the drop-down list **Signal source**, select the desired signal source. Note that the desired Modbus server must be activated in the Cluster Controller when you are using the Modbus (see Section 12.1, page 60).
 - In the drop-down list **Predefined Quantity**, select the setpoint **cos Phi**.
6. When using the digital inputs, make the settings for the digital inputs:
- Select the group **Settings of digital inputs**.
 - In the field **Failure tolerance time**, enter a value above 1 if possible. This prevents e.g. a brief, simultaneous activation of two relays of a ripple control receiver during a Cluster Controller status change being classified as an invalid status.
7. When using the analog inputs, make the settings for the analog inputs:
- Select the group **Settings of analog inputs**.
 - In the field **Failure tolerance time**, enter the desired time interval.
 - In the field **Initial value input signal**, enter the desired value.
 - In the field **Final value input signal**, enter the desired value.
 - In the field **Cos Phi start setpoint**, enter the desired value.
 - In the drop-down list **Excitation type**, select the desired excitation type.
 - In the field **Cos Phi end setpoint**, enter the desired value.
 - In the drop-down list **Excitation type**, select the desired excitation type.
8. When using the digital inputs, set the status configuration:
- Select the group **Status configuration**.
 - The columns **cos Phi** and **Excitation type** are also displayed.
 - Depending on the number of digital inputs used in the column **Active**, activate the selection field of the status to be configured in each case.
 - In the column **cos Phi**, enter the desired value.
 - In the drop-down list **Excitation type**, select the desired excitation type.
9. Make the settings for the fallback (see Section 13.5, page 70).

13.5 Making Settings for Fallback

Fallback is an operating mode in the Cluster Controller used for grid management services.

There are two types of fallback.

- Fallback in case of missing or invalid external setpoint
- Fallback in case of failure of Speedwire communication between Cluster Controller and inverters

Fallback in Case of Missing or Invalid External Setpoint

This type of fallback is an operating mode containing setpoints which are implemented by the Cluster Controller if it classifies a setpoint as invalid or does not receive a setpoint within a configurable time. The Cluster Controller classifies a setpoint as invalid if there is no configuration for the setpoint available in the Cluster Controller or if the setpoint is not within the value range configured in the Cluster Controller. In the event of an invalid or missing setpoint, the fallback prevents the Cluster Controller from continuing to transmit to the inverter setpoints which may no

longer be up to date. This prevents potential yield loss. The fallback must be activated and configured via the user interface of the Cluster Controller. In the event of an invalid or missing setpoint and configured fallback, the Cluster Controller only retains the last valid setpoint for a limited, configurable time. Once this fallback time has elapsed, the Cluster Controller implements the setpoints that were assigned to the fallback. As soon as a valid setpoint is available again, the fallback is reset and the Cluster Controller implements the current setpoint.

Requirement:

- The activation and the configuration of the fallback must be agreed upon with the grid operator.

Procedure:

1. Log into the Cluster Controller as **Installer**.
2. In the system tree, select the Cluster Controller and select the menu **Grid management services** in the device menu.
3. Select the parameter group for which the fallback settings are to be made:
 - To configure the fallback for the active power limitation, select the parameter group **Active power > Fallback settings**.
 - To configure the fallback for the reactive power setpoint, select the parameter group **Reactive power > Fallback settings**.
4. Select [**Edit**].
5. Make the desired settings for the fallback:
 - In the drop-down list **Fallback activated**, select the entry **Yes**.
 - In the field **Fallback activates after**, enter the desired time after which the fallback is to be activated.
 - Depending on the parameter group and the selected setpoint, enter the desired value in the field **Active power** or **Reactive power** or **cos Phi**.
 - If **cos Phi** is selected as setpoint, select the desired excitation type in the drop-down list **Excitation type**.
6. Select [**Save**].

Fallback in Case of Failure of Speedwire Communication between Cluster Controller and Inverters

i In inverters with Speedwire Webconnect Piggy-Back, fallback in case of failure of Speedwire communication is not configurable

It is not possible to configure fallback in case of failure of Speedwire communication in inverters with Speedwire Webconnect Piggy-Back. This kind of fallback is designed for inverters with Speedwire/Webconnect data module and inverters of the type Sunny Boy Smart Energy.

With this kind of fallback, you can configure which setpoints the inverters in the system are to implement if the Speedwire communication between the Cluster Controller and the inverters fails and the inverters do not receive any setpoints within a configurable time interval.

Requirement:

- The inverters in the system must be equipped with the latest inverter firmware version (see product page of the inverter at www.SMA-Solar.com).

Procedure:

1. Log into the Cluster Controller as **Installer**.
2. Select the system in the system tree and select the menu **Settings** in the device menu.
3. Select the parameter group **System & device control system (Solar Inverters)**.
4. Select [**Edit**].
5. Select the group **Configuration of system control via communication**.
6. To set the fallback for reactive power setpoint to the setpoint **cos Phi**, select the group **cos Phi, specified by PV system control**.
7. To set the fallback for reactive power setpoint to the setpoint **Reactive power in %**, select the group **Q specified by PV system control**.
8. To set the fallback for active power limitation, select the group **Act. power lim. via PV system ctrl.**
9. Select [**Edit**].
10. Make the desired settings.
11. Select [**Save**].

14 Update

14.1 Automatic Update (Recommended)

14.1.1 Setting the Automatic Update for Cluster Controller

In the automatic update of the Cluster Controller, only update files for the Cluster Controller are taken into account. The update files are downloaded via the Internet from the SMA Update Portal. The Cluster Controller checks once a day whether a new update is available. If a new update is available, the Cluster Controller downloads the update. The update process starts automatically the following night at 11 p.m. Settings already made for the Cluster Controller and the system data are retained after the update. If an automatic update process for the Cluster Controller is interrupted, e.g. due to a power outage, the Cluster Controller restarts the update process at the next possible time.

Requirement:

- The Cluster Controller must be connected to the Internet.

Procedure:

1. Select the Cluster Controller in the system tree and select the menu **Settings** in the device menu.
2. Select the parameter group **Device > Update**.
3. Select **[Edit]**.
4. Select the desired entry in the drop-down list **Automatic update**:

Entry	Explanation
Yes	Activates the automatic update
No	Deactivates the automatic update

5. Select **[Save]**.

14.1.2 Setting the Automatic Update for Connected SMA Devices

i No update is performed for inverters with communication errors

No update is performed for inverters that are not connected to the Cluster Controller as a result of a communication error.

- Using the inverter event log, determine the cause for the communication error and rectify the error so that the inverter is no longer displayed with the  symbol in the system tree.

i Sufficient DC input voltage is required for update

For some inverters, updates are only possible above a specific DC input voltage. Depending on the time of day, the weather, or the condition of the PV modules (e.g. affected by pollution or covered with snow), the DC input voltage may be too low for the update. The affected inverters do not feed in during the update. This can result in temporary yield losses.

i Do not change the update source during the automatic update process

If the update source is changed during the automatic update process, the update process does not continue. Update files that have already been sent to the inverters cannot be withdrawn.

- Do not change the update source during the automatic update process.

As update sources for the automatic update of SMA devices, you can select the SMA Update Portal or a USB data carrier connected to the Cluster Controller. When updating via the SMA Update Portal, the Cluster Controller checks once a day whether a new update is available. If a new update is available, the Cluster Controller downloads the update. When updating via the USB data carrier, available update files are copied directly to the Cluster Controller. For both update sources, the sending of the update files starts automatically the following night at 4 a.m. If an automatic update process for the inverters in the system is interrupted by a power outage, for example, the Cluster Controller restarts the update process the following day.

Procedure:

1. In the system tree, select the system and select the menu **Updates** in the device menu.
2. Select the parameter group **Settings**.
3. Select [**Edit**].
4. To deactivate the automatic update, select the entry **No** in the drop-down list **Activated**.
5. To activate the automatic update, make the following settings:
 - In the drop-down list **Activated**, select the entry **Yes** (default setting).
 - In the drop-down list **Operating mode**, select the entry **Automatic update**.
 - In the drop-down list **Update source**, select the desired update source:

Update source	Explanation
Update portal	The update files are downloaded from the SMA Update Portal on the Internet.
USB port 2	The update files are downloaded from the USB data carrier that is connected to USB port 2 .

6. Select [**Save**].
 7. If a USB data carrier is to be used as an update source, prepare the USB data carrier:
 - Select the desired update file and download onto the computer (update files are available at www.SMA-Solar.com).
 - Connect the USB data carrier to the computer.
 - In the first partition of the USB data carrier, create a file folder in the root directory with the title **UPDATE**. If there is more than one partition on the USB data carrier, the Cluster Controller only searches the first partition for update files.
 - Copy the downloaded update file (*.up2) to the **UPDATE** folder.
 - Connect the USB data carrier to USB port **2** of the Cluster Controller.
- The Cluster Controller copies the update file from the USB data carrier and displays the update file status as **Ready** in the area **Available updates** after the download has been completed successfully.

14.2 Manual Update

14.2.1 Carrying Out a Manual Update for Cluster Controller

You can always perform a manual update, even if the automatic update is activated for the Cluster Controller. Settings already made for the Cluster Controller and the system data are retained after the update.

You have the following options for performing the manual update:

- Performing a manual update via the Internet
- Performing a manual update via the user interface
- Performing a manual update via the USB data carrier

Performing a Manual Update via the Internet

Requirement:

- The Cluster Controller must be connected to the Internet.

Procedure:

1. Select the Cluster Controller in the system tree and select the menu **Settings** in the device menu.
2. Select the parameter group **Device > Update**.
3. In the field **Check for update and install it**, select **[Execute]**.
- The Cluster Controller checks whether a new update is available. If a new update is available, the Cluster Controller downloads the update from the SMA Update Portal and starts the update process.

Performing a Manual Update via the User Interface

1. Select the desired update file and download onto the computer (update files are available at www.SMA-Solar.com).
2. Log into the Cluster Controller as **Installer**.
3. Select the Cluster Controller in the system tree and select the menu **Update and save** in the device menu.
4. Select the parameter group **Update**.
5. In the field **Upload update file (*.up2)**, select **[Browse...]**.
 - The file selection window opens.
6. Select the desired update file and select **[Open]**.
 - The name of the update file is displayed in the field **Upload update file (*.up2)**.
7. Select **[Execute]**.
- The update file is uploaded and executed.

Performing a Manual Update via the USB Data Carrier

1. Prepare the USB data carrier:
 - Select the desired update file and download onto the computer (update files are available at www.SMA-Solar.com).

- Connect the USB data carrier to the computer.
 - In the first partition of the USB data carrier, create a file folder in the root directory with the title **UPDATE**. If there is more than one partition on the USB data carrier, the Cluster Controller only searches the first partition for update files.
 - Copy the downloaded update file (*.up2) to the **UPDATE** folder, then remove the USB data carrier from the computer.
2. Connect the USB data carrier to USB port **2** of the Cluster Controller.
- The update file is uploaded and executed.

14.2.2 Performing a Manual Update for Connected SMA Devices

You have the following options for performing the manual update for connected devices:

- Performing a Manual Update via the Internet
- Performing a Manual Update via the User Interface
- Performing a Manual Update via the USB Data Carrier

Settings already made for the Cluster Controller and the system data are retained after the update.

i Sufficient DC input voltage is required for update

For some inverters, updates are only possible above a specific DC input voltage. Depending on the time of day, the weather, or the condition of the PV modules (e.g. affected by pollution or covered with snow), the DC input voltage may be too low for the update. The affected inverters do not feed in during the update. This can result in temporary yield losses.

Performing a Manual Update via the Internet

i Do not change the update source during the automatic update process

If the update source is changed during the automatic update process, the update process does not continue. Update files that have already been sent to the inverters cannot be withdrawn.

- Do not change the update source during the automatic update process.

Requirement:

- The Cluster Controller must be connected to the Internet.

Procedure:

1. Activate the manual update:
 - In the system tree, select the system and select the menu **Updates** in the device menu.
 - Select the parameter group **Settings** and select [**Edit**].
 - In the drop-down list **Activated**, select the entry **Yes**.
 - In the drop-down list **Operating mode**, select the entry **Manual update**.
 - In the drop-down list **Update source**, select the entry **Update portal**.
 - Select [**Save**].
2. Select the desired device type, e.g. SB 5000TL-21.

3. In the area **Available updates**, highlight the desired update file and select [**Download**].

The Cluster Controller downloads the update file from the Internet and displays the update file status as **Ready** in the area **Available updates** after the download has been completed successfully.

The update file has not been downloaded?

Possible error cause: The Internet connection has been interrupted

- Restore the Internet connection.

4. Select [**Send**].

The Cluster Controller checks the saved files.

The Cluster Controller sends the update file once a day on up to five sequential days to the devices in the system. The update process was successful if the version number of the sent update file is displayed for all affected devices.

No device, or not all affected devices, report back with the version number of the sent update file?

- Rectify the error (see Section 18.2, page 96).

Performing a Manual Update via the User Interface

1. Select the desired update file and download onto the computer (update files are available at www.SMA-Solar.com).

2. Log into the Cluster Controller as **Installer**.

3. In the system tree, select the system and select the menu **Updates** in the device menu.

4. Select the parameter group **Update**.

5. In the field **Upload update file (*.up2)**, select [**Browse...**].

The file selection window opens.

6. Select the desired update file and select [**Open**].

The name of the update file is displayed in the field **Upload update file (*.up2)**.

7. Select [**Execute**].

The update file is uploaded and executed.

Performing a Manual Update via the USB Data Carrier

1. Prepare the USB data carrier:

- Select the desired update file and download onto the computer (update files are available at www.SMA-Solar.com).
- Connect the USB data carrier to the computer.
- In the first partition of the USB data carrier, create a file folder in the root directory with the title **UPDATE**. If there is more than one partition on the USB data carrier, the Cluster Controller only searches the first partition for update files.
- Copy the downloaded update file (*.up2) to the **UPDATE** folder, then remove the USB data carrier from the computer.

2. Connect the USB data carrier to USB port **2** of the Cluster Controller.

3. Start the update process:

- In the system tree, select the system and select the menu **Updates** in the device menu.
 - Select the desired device type, e.g. SB 5000TL-21.
 - In the area **Available updates**, highlight the desired update file and select [**Download**].
 - The Cluster Controller copies the update file from the USB data carrier and displays the update file status as **Ready** in the area **Available updates** after the download has been completed successfully.
4. Remove the USB data carrier from the Cluster Controller.
 5. Select [**Send**].
 - The Cluster Controller checks the saved files.
 - The Cluster Controller sends the update file once a day on up to five sequential days to the devices in the system. The update process was successful if the version number of the sent update file is displayed for all affected devices.
 - No device, or not all affected devices, report back with the version number of the sent update file?
 - Rectify the error (see Section 18.2, page 96).

15 Passwords and SMA Grid Guard

15.1 Requirements for a Secure System Password

From the perspective of system communication, all devices with the same password form a system. For this reason, a password used for all devices in a system is called a system password. You can only access all devices in your system with the Cluster Controller if all devices have the same system password.

The system password that you enter for your respective user group when logging into the Cluster Controller user interface for the first time is a default system password. For security reasons, you should change the default system password as soon as possible following commissioning (see Section 15.2, page 79).

You can increase the security of your system password with the following measures:

- Select system passwords containing at least eight characters.
- Use combinations of upper-case and lower-case letters, special characters and numbers.
- Do not use names or common words (e.g. "dog", "cat", "house").
- For the system password, avoid using words that have any personal relevance to you such as the names of persons or pets, personnel numbers, identification numbers or car license plates.
- Do not repeat names or words (e.g. "househouse" or "catcat").
- Do not use combinations of numbers or letters in the same order as they appear on your keyboard (e.g. "12345", "qwert").

15.2 Changing the System Password

Requirement:

- If you wish to change the system password for the user group **Installer**, you must be an **Installer** yourself (see Section 4.1, page 22).

System password requirements:

- The system password can be a maximum of twelve characters.
- Permissible special characters: ? _ ! -

Procedure:

1. Select the Cluster Controller in the system tree and select the menu **Settings** in the device menu.
 2. Select the parameter group **User rights > Access control**.
 3. Select **[Edit]**.
 4. Enter the new system password:
 - Depending on the rights of the user group, enter a new system password in the field **Set installer password** or **Set user password**.
 - In the field **Confirm password**, enter the new system password again.
 5. Select **[Save]**.
- The Cluster Controller changes the system password for all devices in the system.

15.3 Adapting the Device Password to the System Password

If the password of a device is different from the system password, the device will be displayed with a padlock symbol in the system tree. This is the case, for example, when adding new inverters to an existing system.

Procedure:

To adapt the device password to the system password, perform the following actions in the specified order. The exact procedure is described in the following sections.

- Adapting the system password to the device password
- Resetting the system password

Adapting the System Password to the Device Password

In order to access the device marked with the padlock symbol, you must first adapt the system password to the device password. For new devices, the device password corresponds to the default system password. The default system password of the user group **User** is "0000"; the default system password of the user group **Installer** is "1111".

Procedure:

1. Log into the Cluster Controller as **Installer**.
2. Select the Cluster Controller in the system tree and select the menu **Settings** in the device menu.
3. Adapt the system password to the device password:
 - Select the parameter group **User rights > Access control**.
 - Select **[Edit]**.
 - In the field **Set installer password**, enter the default system password **1111**.
 - In the field **Confirm password**, confirm the default system password.
 - In the field **Set user password**, enter the default system password **0000**.
 - In the field **Confirm password**, confirm the default system password.
 - Select **[Save]**.
 - The Cluster Controller changes the device password for all approved devices in the system.
4. Restart the Cluster Controller via the user interface (see Section 18.3, page 108).

Resetting the System Password

1. Log into the Cluster Controller as **Installer**.
2. Select the Cluster Controller in the system tree and select the menu **Settings** in the device menu.
3. Reset the system password to the previous system password:
 - Select the parameter group **User rights > Access control**.
 - Select **[Edit]**.

- In the field **Set installer password**, enter the previous system password for the user group **Installer**.
 - In the field **Confirm password**, confirm the system password.
 - In the field **Set user password**, enter the previous system password of the user group **User**.
 - In the field **Confirm password**, confirm the system password.
 - Select [**Save**].
 - The Cluster Controller changes the device password for all approved devices in the system. All devices have now been reset to the previous system passwords.
4. Select [**Save**].
 5. Restart the Cluster Controller via the user interface (see Section 18.3, page 108).
- After a maximum of two minutes, the new device is displayed without a padlock symbol in the system tree.

15.4 Procedure on Loss of System Passwords

15.4.1 Requesting a PUK

If you have forgotten the system passwords for both user groups, then you can unlock the inverters using a PUK (Personal Unlocking Key). For every inverter, there is one PUK for each user group (**User** and **Installer**).

Procedure:

1. Download the PUK application form (application form available at www.SMA-Solar.com).
2. Complete the application form and sign it.
3. Send the application form to the Service by e-mail, fax or mail (see Section 20, page 111).

15.4.2 Unlocking Inverters with PUKs

Unlocking several inverters using a PUK

Each PUK is only valid for one inverter and one user group.

- If you have requested PUKs for several inverters, you must unlock each inverter individually with the corresponding PUK.

Communication connection required between the Cluster Controller and the inverter during the unlocking process

In order for the changed password settings to become effective, there must be a communication connection between the Cluster Controller and the respective inverter during the unlocking process.

- Only unlock the inverter with PUK if there is a communication connection to the inverter. The inverter must not be displayed with a communication error (.

Procedure:

1. Reset the password settings of the Cluster Controller via the display:
 - Select the display view **Settings**. To do this, simultaneously press and hold the **[OK]** and **[ESC]** buttons on the keypad for two seconds.
 - The display view **Settings** opens.
 - Select the **Reset password** line and press **[OK]**.
 - The display view **Confirm the resetting** appears.
 - Select **OK** and confirm with **[OK]**.
 - The user password and the installer password are reset.
 2. Log into the Cluster Controller as **Installer** with the default system password **1111**.
 - The inverters are each displayed with a padlock symbol in the system tree.
 3. Adapt the installer password of the Cluster Controller to the PUK of the desired inverter. As a result, the inverter can be accessed again:
 - Select the Cluster Controller in the system tree and select the menu **Settings > User rights > Access control** in the device menu.
 - Select **[Edit]**.
 - In the field **Set installer password**, enter the PUK of the desired inverter as the new system password.
 - In the field **Confirm password**, enter the new system password again.
 - Select **[Save]**.
 - The Cluster Controller changes the system password for the user group **Installer** and the inverter is no longer displayed with a padlock symbol in the system tree.
 4. To unlock additional inverters, repeat step 3 for the desired inverters.
 5. Adapt the installer password and the user password of the Cluster Controller to the desired system passwords:
 - Select the Cluster Controller in the system tree and select the menu **Settings > User rights > Access control** in the device menu.
 - Select **[Edit]**.
 - In the field **Set installer password**, enter the desired system password for the user group **Installer** as a new system password.
 - In the field **Confirm password**, enter the new system password again.
 - In the field **Set user password**, enter the desired system password for the user group **User**.
 - In the field **Confirm password**, enter the new system password again.
 - Select **[Save]**.
- The Cluster Controller changes the system passwords of both user groups and transmits the changed system passwords to the inverters.

15.5 Setting SMA Grid Guard Mode

When the inverters are delivered, the SMA Grid Guard parameters have a default setting depending on the country. Changes to the SMA Grid Guard parameters must always be agreed upon with the grid operator and are recorded in the event logs of the inverters. To change SMA Grid Guard parameters, the SMA Grid Guard mode must be activated on the Cluster Controller user interface. For this purpose, you require a personal SMA Grid Guard code. You can request your personal SMA Grid Guard code from SMA Solar Technology AG (application for the SMA Grid Guard code available at www.SMA-Solar.com).

Requirements:

- The responsible grid operator must approve changes to grid-relevant parameters.
- The SMA Grid Guard code for changing the grid-relevant parameters must be available (application for the SMA Grid Guard code available at www.SMA-Solar.com).

Procedure:

1. Log into the Cluster Controller as **Installer**.
 2. Select the SMA Grid Guard symbol () in the status bar.
 - The SMA Grid Guard dialog window opens.
 3. Set the SMA Grid Guard mode:
 - To activate the SMA Grid Guard mode, enter the personal SMA Grid Guard code in field **Individual access code**.
 - To deactivate the SMA Grid Guard mode, enter the blocking code **54321** in field **Individual access code**.
 4. Select [**OK**].
- The SMA Grid Guard mode is set. In the system tree, updating the symbols for access rights (SMA Grid Guard symbol and padlock symbol) can take up to two minutes.

16 Setting Up Access via the Internet

If the Cluster Controller is integrated in a LAN with a router, you can also access the user interface of the Cluster Controller via the Internet. You have the following options:

- Access via Sunny Portal
- Access via WAN IP Address
- Access via DynDNS

i Ensuring data security in Ethernet networks

When accessing via the Internet, there is a risk that unauthorized users may access and manipulate the data or devices in your system.

- Take suitable protective measures (e.g. set up a firewall, close network ports that are not required, only enable remote access via VPN tunnel).

Access via Sunny Portal

Requirements:

- The Cluster Controller must be registered in Sunny Portal (see Section 11.1, page 56).
- Corresponding port forwarding must be set up in the router (see router manual). The Cluster Controller is set to HTTP port 80 and NAT port 80 by default.

Procedure:

- In Sunny Portal, select the Cluster Controller on the page **Configuration > Device overview**.
 - The login page of the Cluster Controller opens.

Access via WAN IP Address

Requirement:

- Corresponding port forwarding must be set up in the router (see router manual). The Cluster Controller is set to HTTP port 80 and NAT port 80 by default.

Procedure:

1. Select the Cluster Controller in the system tree and select the menu **Settings** in the device menu.
2. Select the parameter group **External communication > Nat**.
3. The WAN IP address is shown in the field **WAN IP**.
4. In order to call up the Cluster Controller user interface later on via the Internet, enter the previously noted WAN IP address in the address line of the web browser. If you have changed the port, you must also specify the port.

Example: Entering the WAN IP address and the port

The WAN IP address is "83.246.95.22" and the port is "81".

- Enter **http://83.246.95.22:81** in the address line of the web browser.
-

Access via DynDNS

1. Set up the desired Internet address with a DynDNS service, e.g. at dyndns.com.
2. Set up the router for DynDNS (see router manual).
3. Set up corresponding port forwarding in the router (see router manual). The Cluster Controller is set to HTTP port 80 and NAT port 80 by default.

17 Network Configuration

17.1 Configuration for Static LAN

17.1.1 Configuring the Cluster Controller for Static LAN

i Different IP address ranges required for Speedwire network and LAN

In order for an unambiguous assignment of the IP addresses in the Speedwire network and in the LAN to be possible from the perspective of the Cluster Controller, the IP address ranges of both networks must be different. By default, the Cluster Controller uses address range 172.22/16 (172.22.0.1 to 172.22.255.255) for the Speedwire network.

- Ensure that different IP address ranges are used for the Speedwire network and the LAN.

i Observe the configuration of the router and the network switch

For the Speedwire connection, the product uses IP addresses from the Unicast range and also IP addresses from the Multicast range 239/8 (239.0.0.0 to 239.255.255.255).

- When using a router or network switch, ensure that the router and the network switch forward the Multicast telegrams required for the Speedwire connection to all nodes in the Speedwire network (for further information on how to configure the router or network switch, see the manual from the manufacturer).

Procedure:

1. Write down the previous IP address, subnet mask and gateway address of the computer.
2. Connect the computer to port **X13** or **X14** on the Cluster Controller.
3. Read off and write down the IP address of the Cluster Controller from the display:
 - Select the display view **External communication**.
 - Read off the IP address from the **IP address** line and write it down.
4. Adapt the network settings of the computer:
 - Adapt the IP address.

Example: adapting the IP address of the computer to the address range of the Cluster Controller

The IP address of the Cluster Controller is "169.254.0.3" and the IP address of the computer is "10.4.33.105".

- Change the IP address of the computer to **169.254.0.4**.
-
- Change the subnet mask to **255.255.0.0**.
 - Ensure that no gateway address is entered.
5. Call up the Cluster Controller via the IP address read off from the display and log in.
 6. Select the Cluster Controller in the system tree and select the menu **Settings** in the device menu.
 7. Disable DHCP if it has not yet been disabled.
 - Select the parameter group **External communication > Ethernet > DHCP**.
 - Select **[Edit]**.

- In the drop-down list **Activated**, select the entry **No**.
8. In the group **Ethernet**, make the desired settings for the static LAN and select [**Save**].
 - The Cluster Controller saves the network settings and can no longer be accessed via the old IP address.
 9. Adapt the network settings of the computer back to the previous network settings that were written down.
 10. Check whether the Cluster Controller can be accessed via the new IP address.

If the Cluster Controller cannot be accessed via the new IP address, it is likely that the Cluster Controller network settings are incorrect.

 - Check the network settings and adjust if required.
 11. Connect the Cluster Controller and the computer to the desired node in the static local area network.

17.1.2 Configuring the Inverter for a Static LAN

You have the option of assigning static IP addresses to the inverters in the system. The inverters are configured for automatic address allocation via DHCP by default.

Procedure:

1. Log into the Cluster Controller.
2. Select the desired inverter in the system tree.
3. Select the menu **Settings > System communication** in the device menu.
4. Select [**Edit**].
5. In the drop-down list **Automatic configuration switched on**, select the entry **No**. This deactivates the automatic assignment of the IP address for the inverter.
6. In the field **IP address**, enter the desired static IP address.
7. Select [**Save**].

17.2 Making the Proxy Configuration

When using a proxy server, you must make a corresponding proxy configuration in order to be able to access the Cluster Controller user interface within the LAN or to enable the Cluster Controller to access the Internet, e.g. for connecting to Sunny Portal.

Enabling access to the user interface of the Cluster Controller

- In the web browser, include the IP address of the Cluster Controller in the list of proxy exceptions.

Enabling Cluster Controller access to the Internet

1. Log into the Cluster Controller.
2. Select the Cluster Controller in the system tree and select the menu **Settings** in the device menu.

3. Select the parameter group **External communication > Proxy settings** and make the desired proxy configuration. Tip: The proxy settings for the web browser can usually be adopted for the Cluster Controller.
4. Select [**Save**].

17.3 Making the DHCP Configuration

1. Select the Cluster Controller in the system tree and select the menu **Settings** in the device menu.
2. Select the parameter group **External communication > Ethernet > DHCP**.
3. Select [**Edit**].
4. Make the desired DHCP settings:
 - To activate DHCP, select the entry **Yes** in the drop-down list **Activated**.
 - To deactivate DHCP, select the entry **No** in the drop-down list **Activated**.
5. Select [**Save**].

17.4 Changing the HTTP Port

i When calling up the Cluster Controller, specify the IP address and the changed HTTP port

If you have changed the default HTTP port configured in the Cluster Controller, you must specify this changed HTTP port together with the IP address of the Cluster Controller when calling up the user interface.

Example: Calling up the user interface of the Cluster Controller after changing the HTTP port

The IP address of the Cluster Controller is 192.168.0.168 and you have changed the HTTP port to 8080.

- To call up the Cluster Controller user interface, enter **http://192.168.0.168:8080** in the address line of the web browser.
-

Procedure:

1. Select the Cluster Controller in the system tree and select the menu **Settings** in the device menu.
2. Select the parameter group **External communication > HTTP**.
3. Select [**Edit**].
4. In the field **Port**, enter the desired port (default setting: port 80).
5. Select [**Save**].

17.5 Changing the NAT Port

1. Select the Cluster Controller in the system tree and select the menu **Settings** in the device menu.
2. Select the parameter group **External communication > Ethernet > Nat**.

3. Select [**Edit**].
4. In the field **Port**, enter the desired port (default setting: port 80).
5. Select [**Save**].

18 Troubleshooting

18.1 LED States



18.1.1 Operation LEDs

Assignment of the Status LED ():



The status LED can display the following statuses:

- Status of the Cluster Controller
- Status of the connected inverters
- Status of the system communication
- Status of the grid management services



If the status LED is not glowing green after commissioning, refer also to the event log of the Cluster Controller to determine the precise cause of the error. The details of each error are logged in the event log (see Section 9.1, page 51).

LED	Status	Cause and corrective measure
All	off	<p>The Cluster Controller is not connected to the voltage supply.</p> <p>Corrective measures:</p> <ul style="list-style-type: none"> • Connect the Cluster Controller to the voltage supply (see the Cluster Controller installation manual). <hr/> <p>The voltage supply is reverse-connected or the power supply unit is defective.</p> <p>Corrective measures:</p> <ul style="list-style-type: none"> • Ensure that the voltage supply is correctly connected (see the Cluster Controller installation manual). • If the voltage supply is connected correctly, replace the power supply unit.
Power () and status ()	Power glowing red, status glowing yellow or red	<p>The voltage supply is too low.</p> <p>Corrective measures:</p> <ul style="list-style-type: none"> • Ensure that the connected voltage supply is sufficient (see the Cluster Controller installation manual). • If the problem persists, contact the Service (see Section 20, page 111).
Power ()	glowing green	<p>The start procedure is complete. The Cluster Controller is ready for operation.</p>

LED	Status	Cause and corrective measure
Status ()	glowing green	Normal operation
	glowing yellow	<p>At least one device has the status Warning.</p> <p>Corrective measures:</p> <ul style="list-style-type: none"> • Check the Cluster Controller event log (see Section 9.1, page 51). • Refer to the device documentation.
		<p>Communication with at least one device is disturbed. There may be a disturbance in the device.</p> <p>Corrective measures:</p> <ul style="list-style-type: none"> • Check the Cluster Controller event log (see Section 9.1, page 51). • Refer to the device documentation.
		<p>Communication with at least one device is disturbed. The Cluster Controller may not be connected to the device.</p> <p>Corrective measures:</p> <ul style="list-style-type: none"> • Ensure that the network cables are correctly connected (see the Cluster Controller installation manual). • Check whether the network components, network cables or connectors are defective or damaged. Replace defective or damaged network components, network cables or connectors. • Check whether the network settings of the individual network components are correct. Adapt the network settings if required. • If the problem persists, contact the network administrator.

LED	Status	Cause and corrective measure
Status ()	flashing yellow	<p>An update of the Cluster Controller or the connected devices is currently taking place.</p> <hr/> <p>The active power limitation is active and the default value is above 0% and below 100%.</p> <hr/> <p>The reactive power setpoint is active. The default value is not 0% or the displacement power factor $\cos \varphi$ is below 1.</p>
	glowing red	<p>The active power limitation is active and the default value is 0%.</p> <hr/> <p>At least one device has the status Error.</p> <p>Corrective measures:</p> <ul style="list-style-type: none"> • Check the Cluster Controller event log (see Section 9.1, page 51). • Refer to the device documentation.
Status ()	glowing red	<p>Communication with all devices is disturbed. There is a problem in the LAN.</p> <p>Corrective measures:</p> <ul style="list-style-type: none"> • Ensure that the network cables are correctly connected (see the Cluster Controller installation manual). • Check whether the network components, network cables or connectors are defective or damaged. Replace defective or damaged network components, network cables or connectors. • Check whether the network settings of the individual network components are correct. Adapt the network settings if required. • Restart the Cluster Controller if required. Disconnect the Cluster Controller from the voltage supply and reconnect it to the voltage supply. • If required, assign a fixed IP address for the Cluster Controller (see Section 17.1.1, page 86). • If the problem persists, contact the network administrator.

LED	Status	Cause and corrective measure
Status ()	glowing red	<p>The SD memory card in the Cluster Controller may be defective.</p> <p>Corrective measures:</p> <ul style="list-style-type: none"> • Check the Cluster Controller event log (see Section 9.1, page 51). • If the SD memory card is defective, contact the Service (see Section 20, page 111).
	flashing red	<p>The Cluster Controller could not start correctly. A system error has occurred.</p> <p>Corrective measures:</p> <ul style="list-style-type: none"> • Contact the Service (see Section 20, page 111).

LED	Status	Cause and corrective measure
Data carrier status ( off)	off	<p>The Cluster Controller is starting and no information is yet available for data export or for the USB data carrier.</p> <p>Corrective measures:</p> <ul style="list-style-type: none"> Wait until the Cluster Controller has completed the start process and is ready for operation. Once the start process is complete, the power LED () will glow green.
		<p>No USB data carrier was detected. It is possible that no USB data carrier is connected or the USB data carrier is not compatible.</p> <p>Corrective measures:</p> <ul style="list-style-type: none"> Ensure that a compatible USB data carrier is connected (see the Cluster Controller installation manual).
	glowing green	<p>The USB data carrier is compatible. The free storage capacity is above 10%.</p>
	glowing yellow	<p>The USB data carrier connected to USB port 1 is compatible but the free storage capacity is no more than 10%.</p> <p>Corrective measures:</p> <ul style="list-style-type: none"> Delete files that are no longer required from the USB data carrier. <p>or</p> <ul style="list-style-type: none"> Replace the USB data carrier with a USB data carrier that has sufficient free storage capacity.
Data carrier status ( glowing red)	glowing red	<p>The USB data carrier connected to USB port 1 is full or write-protected.</p> <p>Corrective measures:</p> <ul style="list-style-type: none"> If the USB data carrier is full, replace the USB data carrier. If the USB data carrier is write-protected, remove the write protection or use a USB data carrier without write protection.
	flashing green or yellow or red	<p>Write/read access is currently being performed on the USB data carrier.</p> <ul style="list-style-type: none"> Only remove the USB data carrier once the data carrier status LED is no longer flashing.

18.1.2 Network Port LEDs

LED	Status	Cause and corrective measure
Link/activity (green)	off	<p>No network connection established. The Cluster Controller is not connected to the voltage supply.</p> <p>Corrective measures:</p> <ul style="list-style-type: none"> Connect the Cluster Controller to the voltage supply (see the Cluster Controller installation manual).
		<p>No network connection established. The network cable is not correctly connected to the Cluster Controller, the router or the network switch.</p> <p>Corrective measures:</p> <ul style="list-style-type: none"> Ensure that the network cables are correctly connected (see the Cluster Controller installation manual).
		<p>No network connection established. One or more network components, network cables or connectors are defective or damaged.</p> <p>Corrective measures:</p> <ul style="list-style-type: none"> Replace the defective or damaged network components, network cables or connectors.
	flashing	<p>Network connection established. Data is being sent or received.</p>
Speed (yellow)	off	<p>Network connection established. The data transfer rate is up to 10 Mbit/s.</p>
	on	<p>Network connection established. The data transfer rate is up to 100 Mbit/s.</p>

18.2 Errors in the Cluster Controller or the Connected Devices

General information

Problem	Cause and corrective measure
The Cluster Controller does not start. The LEDs and the display are off.	<p>The Cluster Controller is not connected to the voltage supply.</p> <p>Corrective measures:</p> <ul style="list-style-type: none"> • Ensure that the three-pole plug for the voltage supply is connected to terminal X1 of the Cluster Controller.
	<p>The voltage supply is reverse-connected or the power supply unit is defective.</p> <p>Corrective measures:</p> <ul style="list-style-type: none"> • Ensure that the voltage supply is correctly connected (see the Cluster Controller installation manual). • If the voltage supply is connected correctly, replace the power supply unit.

User Interface and Display

Problem	Cause and corrective measure
The user interface is not displayed properly.	<p>JavaScript is deactivated in the web browser.</p> <p>Corrective measures:</p> <ul style="list-style-type: none"> • Activate JavaScript in the web browser.
The parameters of a device class or of an individual device cannot be edited.	<p>You do not have the necessary rights to edit the parameters (see Section 4.1, page 22).</p> <p>Corrective measures:</p> <ul style="list-style-type: none"> • Change the user group.

Problem	Cause and corrective measure
<p>An incorrect total number of connected inverters is shown on the user interface or the display.</p>	<p>Communication with at least one inverter is disturbed. Either the Cluster Controller has not yet registered with one or more inverters or the connection to one or more inverters has been interrupted.</p> <p>Corrective measures:</p> <ul style="list-style-type: none"> • Wait six minutes and check again whether the correct number of all connected inverters is displayed. <p>If the incorrect number of connected inverters is still displayed:</p> <ul style="list-style-type: none"> - Ensure that the inverters are in operation (see inverter installation manual). - Ensure that the network cables that connect the inverters with one another are correctly connected (depending on the inverter equipment, see the inverter installation manual or the installation manual of the Speedwire/ Webconnect interface). - Ensure that the network cable of the inverter connected directly to the Cluster Controller is connected to network port X9 or X10 of the Cluster Controller. - Ensure that no network components, network cables or connectors are defective.
<p>The expected binary values for the digital signal source are not shown on the display.</p>	<p>The digital signal source is not correctly connected.</p> <p>Corrective measures:</p> <ul style="list-style-type: none"> • Ensure that the digital signal source is correctly connected (see the Cluster Controller installation manual).
<p>No current signal for the analog signal source or the sensor is shown on the display.</p>	<p>The analog signal source or the sensor is probably not correctly connected.</p> <p>Corrective measures:</p> <ul style="list-style-type: none"> • Ensure that the analog signal source is correctly connected (see the Cluster Controller installation manual). • Ensure that the sensor is correctly connected (see the Cluster Controller installation manual).

Problem	Cause and corrective measure
No measured values for the connected temperature sensor are shown on the display.	<p>The temperature sensor is not correctly connected.</p> <p>Corrective measures:</p> <ul style="list-style-type: none"> • Ensure that the temperature sensor is correctly connected (see the Cluster Controller installation manual).
No measured values for the connected irradiation sensor are shown on the display.	<p>If no measured values are displayed for the irradiation sensor, either the characteristic curve of the irradiation sensor is not configured or the irradiation sensor is not correctly connected.</p> <p>Corrective measures:</p> <ul style="list-style-type: none"> • Ensure that the characteristic curve of the irradiation sensor is configured (see Section 7.1, page 40). • Ensure that the irradiation sensor is correctly connected (see the Cluster Controller installation manual).
Though it is not connected, a measured value of up to 2.2 V for pin group Analog voltage input 4 is shown on the display and the user interface.	<p>If no sensor is connected to the pin group Analog voltage input 4, a measured value for this pin group of up to 2.2 V will nevertheless be shown on the display and the user interface of the Cluster Controller.</p> <p>Corrective measures:</p> <ul style="list-style-type: none"> • In order for a measured value of 0 V to be displayed for the pin group Analog voltage input 4 when it is not connected, place a jumper wire between pins B5 and B7 in terminal X8.



Login

Problem	Cause and corrective measure
The login page does not open and the status LED () is flashing red.	<p>The Cluster Controller could not start correctly. A system error has occurred.</p> <p>Corrective measures:</p> <ul style="list-style-type: none"> • Disconnect the Cluster Controller from the voltage supply and reconnect it to the voltage supply. Note that this can lead to loss of system data. • If the problem persists, contact the Service .

Problem	Cause and corrective measure
The login page does not open.	<p>The Cluster Controller is not connected to the voltage supply.</p> <p>Corrective measures:</p> <ul style="list-style-type: none"> • Ensure that the three-pole plug for the voltage supply is connected to terminal X1 of the Cluster Controller.
	<p>The voltage supply is reverse-connected or the power supply unit is defective.</p> <p>Corrective measures:</p> <ul style="list-style-type: none"> • Ensure that the voltage supply is correctly connected (see the Cluster Controller installation manual). • If the voltage supply is connected correctly, replace the power supply unit.
	<p>A firewall is blocking the connection.</p> <p>Corrective measures:</p> <ul style="list-style-type: none"> • Adjust the firewall settings in order to allow the required connection.
	<p>If the Cluster Controller is connected to the LAN via DHCP and the voltage supply of the Cluster Controller was briefly interrupted, it is possible that the DHCP server has assigned the Cluster Controller a new IP address.</p> <p>Corrective measures:</p> <ul style="list-style-type: none"> • Select the display view External communication and read out the current IP address of the Cluster Controller. • Call up the IP address via the web browser.

Problem	Cause and corrective measure
The login page does not open.	<p data-bbox="464 177 750 209">There is a problem in the LAN.</p> <p data-bbox="464 209 688 240">Corrective measures:</p> <ul data-bbox="487 240 1012 742" style="list-style-type: none"> <li data-bbox="487 240 918 336">• Ensure that the network cables are correctly connected to the Cluster Controller (see the Cluster Controller installation manual). <li data-bbox="487 336 1012 456">• Check whether the network components, network cables or connectors are defective or damaged. Replace defective or damaged network components, network cables or connectors. <li data-bbox="487 456 1012 552">• Check whether the network settings of the individual network components are correct. Adapt the network settings if required. <li data-bbox="487 552 1012 671">• Restart the Cluster Controller. Disconnect the Cluster Controller from the voltage supply and reconnect it to the voltage supply. Note that this can lead to loss of system data. <li data-bbox="487 671 912 742">• If the problem persists, contact the network administrator.
The login page does not open.	<p data-bbox="464 742 1012 861">If the Cluster Controller is accessed via the Internet, there may not currently be an Internet connection or the port forwarding to the Cluster Controller from the router may be missing or may have been set up incorrectly.</p> <p data-bbox="464 861 688 893">Corrective measures:</p> <ul data-bbox="487 893 1012 1093" style="list-style-type: none"> <li data-bbox="487 893 1012 957">• In the event of interrupted Internet connection, restore the Internet connection. <li data-bbox="487 957 974 1021">• If port forwarding has not been set up, set up port forwarding to the Cluster Controller on the router. <li data-bbox="487 1021 974 1093">• If port forwarding has already been set up on the router, ensure that it is correct.
Login to the user interface has failed.	<p data-bbox="464 1093 1012 1189">The system password has been entered incorrectly four times. Access to the Cluster Controller is suspended for 15 minutes.</p> <p data-bbox="464 1189 688 1220">Corrective measures:</p> <ul data-bbox="487 1220 1012 1286" style="list-style-type: none"> <li data-bbox="487 1220 1012 1286">• Wait 15 minutes, then log in with the correct system password.

Events and Device Status

Problem	Cause and corrective measure
<p>In the event log, the wrench symbol () is displayed next to the event type.</p>	<p>This event can only be rectified by a user with "Installer" rights.</p> <p>Corrective measures:</p> <ul style="list-style-type: none"> • Contact the user with "Installer" rights and inform them of the serial number of the device and the event number.
<p>In the event log, the telephone receiver symbol () is displayed next to the event type.</p>	<p>This event can only be rectified by SMA Service.</p> <p>Corrective measures:</p> <ul style="list-style-type: none"> • Contact the user with "Installer" rights and inform them of the serial number of the device and the event number. The user with "Installer" rights contacts the Service (see Section 20, page 111).
<p>At least one device has the status Warning or Error.</p>	<p>There may be a disturbance in the device.</p> <p>Corrective measures:</p> <ul style="list-style-type: none"> • Check the Cluster Controller event log (see Section 9.1, page 51). • Refer to the device documentation.

Communication

Problem	Cause and corrective measure
<p>Communication with at least one device is disturbed.</p>	<p>There may be a disturbance in the device.</p> <p>Corrective measures:</p> <ul style="list-style-type: none"> • Check the Cluster Controller event log (see Section 9.1, page 51). • Refer to the device documentation. <hr/> <p>The Cluster Controller may not be connected to the device.</p> <p>Corrective measures:</p> <ul style="list-style-type: none"> • Ensure that the network cables are correctly connected (see the Cluster Controller installation manual). • Check whether the network components, network cables or connectors are defective or damaged. Replace defective or damaged network components, network cables or connectors. • Check whether the network settings of the individual network components are correct. Adapt the network settings if required. • If the problem persists, contact the network administrator.
<p>Communication with all devices is disturbed.</p>	<p>There is a problem in the LAN.</p> <p>Corrective measures:</p> <ul style="list-style-type: none"> • Ensure that the network cables are correctly connected (see the Cluster Controller installation manual). • Check whether the network components, network cables or connectors are defective or damaged. Replace defective or damaged network components, network cables or connectors. • Check whether the network settings of the individual network components are correct. Adapt the network settings if required. • Restart the Cluster Controller. Disconnect the Cluster Controller from the voltage supply and reconnect it to the voltage supply. • If the problem persists, contact the network administrator.

USB and Update

Problem	Cause and corrective measure
The update via the USB data carrier does not start.	<p>There are no update files on the USB data carrier or the update files on the USB data carrier are not located in the UPDATE directory.</p> <p>Corrective measures:</p> <ul style="list-style-type: none"> • Save the desired update files onto the USB data carrier in the UPDATE directory and connect the USB data carrier to USB port 2 of the Cluster Controller.
The Cluster Controller does not write any data to the USB data carrier.	<p>The USB data carrier is connected to USB port 2. The Cluster Controller only writes data to USB data carriers that are connected to USB port 1.</p> <p>Corrective measures:</p> <ul style="list-style-type: none"> • Connect the USB data carrier to USB port 1. Note that the USB data carrier must not be write-protected.
No inverters or not all inverters report back with the version number of the sent update file.	<p>If you have configured the automatic update and the Internet connection was interrupted or is interrupted, the update file may not have been correctly downloaded from the Internet.</p> <p>Corrective measures:</p> <ul style="list-style-type: none"> • Ensure that an Internet connection is established. The automatic update for the inverters starts again on the following day. • To start the update directly, perform a manual update (see Section 14.2.2, page 76).
	<p>The USB data carrier was removed from the Cluster Controller during the update process.</p> <p>Corrective measures:</p> <ul style="list-style-type: none"> • Reconnect the USB data carrier to USB port 2 and perform a manual device update (see Section 14.2.2, page 76).

Problem	Cause and corrective measure
No inverters or not all inverters report back with the version number of the sent update file.	<p>Due to missing DC input voltage to the inverters, an update file has been sent and saved in the inverter but has not yet been run. The DC input voltage can vary depending on the time of day, the weather or the condition of the PV modules (e.g. pollution or covered with snow).</p> <p>Corrective measures:</p> <ul style="list-style-type: none"> To start the update directly, perform a manual update (see Section 14.2.2, page 76).
	<p>After five attempts, the update file could not be sent to the inverters in the system.</p> <p>Corrective measures:</p> <ul style="list-style-type: none"> Check the status of the Speedwire connection of the inverters via the menu Instantaneous values > System communication. Note that the Speedwire connection may also be interrupted due to lack of DC input voltage to the inverters. The DC input voltage can vary depending on the time of day, the weather or the condition of the PV modules (e.g. pollution or covered with snow). To start the update directly, perform a manual update (see Section 14.2.2, page 76).

Energy Meter

Problem	Cause and corrective measure
The Energy Meter is not displayed by the Cluster Controller.	<p>The network cable has not been correctly connected to the Energy Meter.</p> <p>Corrective measures:</p> <ul style="list-style-type: none"> Make sure that the network cable is correctly connected to the network terminal of the Energy Meter (see installation manual of Energy Meter).
	<p>The Energy Meter is not located in the Speedwire network.</p> <p>Corrective measures:</p> <ul style="list-style-type: none"> Depending on the network topology of the system, connect the Energy Meter either to the router or network switch of the Speedwire network, or directly to terminal X9 or X10 of the Cluster Controller.
The Energy Meter is supplying unrealistic measured values.	<p>The Energy Meter has been installed the wrong way round.</p> <p>Corrective measures:</p> <ul style="list-style-type: none"> Reconnect and recommission the Energy Meter (see installation manual of the Energy Meter).

External FTP Server

Problem	Cause and corrective measure
<p>The Cluster Controller does not send any data to the external FTP server.</p>	<p>An error has occurred in the FTP server.</p> <p>Corrective measures:</p> <ul style="list-style-type: none"> • Make sure that there is enough storage space available on the FTP server. • Ensure that the login data for the FTP server are correct. • Ensure that the "Append" function is activated in the FTP server. <hr/> <p>An error has occurred in the LAN.</p> <p>Corrective measures:</p> <ul style="list-style-type: none"> • Check whether the network settings of the individual network components are correct. Adapt the network settings if required. • Check whether the network components are defective or damaged. Replace defective or damaged network components.
<p>The connection test to the external FTP server failed.</p>	<p>The data transmission is incorrectly configured.</p> <p>Corrective measures:</p> <ul style="list-style-type: none"> • Ensure that you have write authorization on the FTP server. • Test the FTP push function (see Section 8.6.2, page 50). <hr/> <p>An error has occurred in the LAN.</p> <p>Corrective measures:</p> <ul style="list-style-type: none"> • Check whether the network settings of the individual network components are correct. Adapt the network settings if required. • Check whether the network components are defective or damaged. Replace defective or damaged network components.
<p>After an FTP download, Internet Explorer shows old system data.</p>	<p>There is a problem with the cache properties of Internet Explorer.</p> <p>Corrective measures:</p> <ul style="list-style-type: none"> • Use a different web browser for the FTP download.

Modbus

Problem	Cause and corrective measure
The Cluster Controller cannot be accessed by the Modbus client.	<p>The required Modbus server is not activated.</p> <p>Corrective measures:</p> <ul style="list-style-type: none"> • Activate the required Modbus server (see Section 12.1, page 60).
	<p>The correct IP address for the Cluster Controller is not set in the Modbus client.</p> <p>Corrective measures:</p> <ul style="list-style-type: none"> • Read off the IP address of Cluster Controller (see Section 10.4.1, page 54). • Ensure that the correct IP address for the Cluster Controller is set in the Modbus client (see manual from manufacturer).
The Modbus profile contains measured values that are not supported by the SMA device.	<p>The Modbus configuration may be incorrect.</p> <p>Corrective measures:</p> <ul style="list-style-type: none"> • Check the Modbus configuration using the assignment tables and adjust if required (see the Technical Description "SMA CLUSTER CONTROLLER Modbus® Interface").
The Cluster Controller does not respond within the response time specified by the Modbus client.	<p>The Modbus configuration may be incorrect.</p> <p>Corrective measures:</p> <ul style="list-style-type: none"> • Check the Modbus configuration using the assignment tables and adjust if required (see the Technical Description "SMA CLUSTER CONTROLLER Modbus® Interface").
The Cluster Controller does not transmit a value specified in the Modbus profile to the devices in the system.	<p>The Modbus configuration may be incorrect.</p> <p>Corrective measures:</p> <ul style="list-style-type: none"> • Check the Modbus configuration using the assignment tables and adjust if required (see the Technical Description "SMA CLUSTER CONTROLLER Modbus® Interface").

Sunny Portal

Problem	Cause and corrective measure
<p>The registration of the Cluster Controller in Sunny Portal failed.</p>	<p>Sunny Portal cannot currently be accessed due to maintenance.</p> <p>Corrective measures:</p> <ul style="list-style-type: none"> • Call up www.SunnyPortal.com and check for any messages regarding maintenance. <hr/> <p>The Cluster Controller is already registered in another Sunny Portal system, for example, if you have replaced the Cluster Controller.</p> <p>Corrective measures:</p> <ul style="list-style-type: none"> • Adjust the system identifier for Sunny Portal in the Cluster Controller (see Section 11.6, page 59).
<p>The registration of another device in Sunny Portal failed.</p>	<p>There may be a firmware problem in the affected device.</p> <p>Corrective measures:</p> <ul style="list-style-type: none"> • Contact the Service (see Section 20, page 111).
<p>The connection test to Sunny Portal has failed.</p>	<p>The data transmission is incorrectly configured.</p> <p>Corrective measures:</p> <ul style="list-style-type: none"> • If the Cluster Controller is not yet registered in Sunny Portal, register the Cluster Controller in Sunny Portal (see Section 11.1, page 56). • Test the connection to Sunny Portal (see Section 11.5, page 58). • Check the settings for Sunny Portal (see Section 11, page 56). <hr/> <p>An error has occurred in the LAN.</p> <p>Corrective measures:</p> <ul style="list-style-type: none"> • Check whether the network settings of the individual network components are correct. Adapt the network settings if required. • Check whether the network components are defective or damaged. Replace defective or damaged network components.

Problem	Cause and corrective measure
<p>The Cluster Controller does not send any data to Sunny Portal.</p>	<p>The data transmission is incorrectly configured.</p> <p>Corrective measures:</p> <ul style="list-style-type: none"> • If the Cluster Controller is not yet registered in Sunny Portal, register the Cluster Controller in Sunny Portal (see Section 11.1, page 56). • Test the connection to Sunny Portal (see Section 11.5, page 58). • Check the settings for Sunny Portal (see Section 11, page 56). <hr/> <p>An error has occurred in the LAN.</p> <p>Corrective measures:</p> <ul style="list-style-type: none"> • Check whether the network settings of the individual network components are correct. Adapt the network settings if required. • Check whether the network components are defective or damaged. Replace defective or damaged network components.
<p>After replacement of the Cluster Controller, two systems with the same system name appear in Sunny Portal.</p>	<p>The system has been registered twice in Sunny Portal. The new Cluster Controller logs into Sunny Portal with a new system identifier. Sunny Portal creates a new system for this system identifier, even if you have given the system the same name.</p> <p>Corrective measures:</p> <ul style="list-style-type: none"> • Assign the system identifier of the old system to the replacement device (see Section 11.6, page 59). • In the replacement device, enter the e-mail address of a user who has administrator rights for the system in Sunny Portal. • In Sunny Portal, delete the new system created by the replacement device.

18.3 Restarting the Cluster Controller via the User Interface

1. Log into the Cluster Controller as **Installer**.
2. Select the Cluster Controller in the system tree and select the menu **Settings** in the device menu.
3. Select the parameter group **Device > System**.
4. In the field **Initiate device restart**, select [**Execute**].
 - The Cluster Controller is restarted. The start-up procedure can take up to two minutes.

18.4 Resetting the Cluster Controller

You can reset the Cluster Controller via the keypad.

Procedure:

1. Call up the display view **Settings**. To do this, simultaneously press and hold the **[OK]** and **[ESC]** buttons on the keypad for two seconds.

The display view **Settings** opens.

2. Select the settings that are to be reset:

Settings to be reset	Explanation
Reset password	The user password and the installer password are reset.
Reset network settings	The network settings of the Cluster Controller are reset.
Reset to default settings	The Cluster Controller is reset to the default settings. Stored system data is deleted.

3. To exit the display view, press **[ESC]**.

4. To confirm the settings that are to be reset, perform the following steps:

- Press **[OK]**.

The display view **Confirm the resetting** appears.

- Select **OK** and confirm with **[OK]**.

The selected settings are reset.

If the network settings were reset or the Cluster Controller was reset to default settings, the Cluster Controller restarts.

5. If you are using Sunny Portal and the Cluster Controller has been reset to default settings, adjust the PV system identifier for Sunny Portal in the Cluster Controller (see Section 11.6, page 59).

19 Accessories

You will find the accessories for your product in the following overview. If required, these can be ordered from SMA Solar Technology AG or your distributor.

Designation	Short description	SMA order number
Top-hat rail power supply unit*	Top-hat rail power supply unit for SMA Cluster Controller	CLCON-PWRSUPPLY
USB flash drive 4 GB	USB flash drive with storage capacity of 4 GB	USB-FLASHDRV4GB
USB flash drive 8 GB	USB flash drive with storage capacity of 8 GB	USB-FLASHDRV8GB

* Not available in all countries. For information on whether an accessory is available in your country, visit the website of your country's SMA subsidiary at www.SMA-Solar.com or contact your distributor.

20 Contact

If you have technical problems with our products, please contact the SMA Service Line. We need the following information in order to provide you with the necessary assistance:

- Cluster Controller:
 - Serial number
 - Firmware version
- Inverters:
 - Type
 - Serial number
 - Firmware version
- When using a retrofitted Speedwire/Webconnect interface:
 - Serial number and firmware version of the Speedwire/Webconnect interface

You can read off the required information from the Cluster Controller user interface. Or you can find the serial number on the type label of the respective product (see the respective product manual). You can also find the serial number and the firmware version of the Cluster Controller in the display view **Cluster Controller**.

Danmark	SMA Solar Technology AG	Belgien	SMA Benelux BVBA/SPRL
Deutschland	Niestetal	Belgique	Mechelen
Österreich	SMA Online Service Center:	België	+32 15 286 730
Schweiz	www.SMA.de/Service	Luxemburg	
	Sunny Boy, Sunny Mini Central, Sunny Tripower: +49 561 9522-1499	Luxembourg	
	Monitoring Systems (Kommunikationsprodukte): +49 561 9522-2499	Nederland	
	Fuel Save Controller (PV-Diesel-Hybridsysteme): +49 561 9522-3199	Česko	SMA Central & Eastern Europe s.r.o.
	Sunny Island, Sunny Backup, Hydro Boy: +49 561 9522-399	Magyarország	Praha
	Sunny Central: +49 561 9522-299	Polska	+420 235 010 417
France	SMA France S.A.S. Lyon +33 472 22 97 00	România	
		Slovensko	
		Ελλάδα	SMA Hellas AE
		Κύπρος	Αθήνα +30 210 9856666

España Portugal	SMA Ibérica Tecnología Solar, S.L.U. Barcelona +34 935 63 50 99	United King- dom	SMA Solar UK Ltd. Milton Keynes +44 1908 304899
Italia	SMA Italia S.r.l. Milano +39 02 8934-7299	France	SMA France S.A.S. Lyon +33 472 22 97 00
United Arab Emirates	SMA Middle East LLC Abu Dhabi +971 2 234-6177	India	SMA Solar India Pvt. Ltd. Mumbai +91 22 61713888
ไทย	SMA Solar (Thailand) Co., Ltd. ประเทศไทย +66 2 670 6999	대한민국	SMA Technology Korea Co., Ltd. 서울 +82-2-520-2666
South Africa	SMA Solar Technology South Africa Pty Ltd. Cape Town 08600SUNNY (78669) International: +27 (0)21 826 0600	Argentina Brasil Chile Perú	SMA South America SPA Santiago +562 2820 2101
Australia	SMA Australia Pty Ltd. Sydney Toll free for Australia: 1800 SMA AUS (1800 762 287) International: +61 2 9491 4200	Other countries	International SMA Service Line Niestetal Toll free worldwide: 00800 SMA SERVICE (+800 762 7378423)

SMA Solar Technology

www.SMA-Solar.com

