

SEC A-A

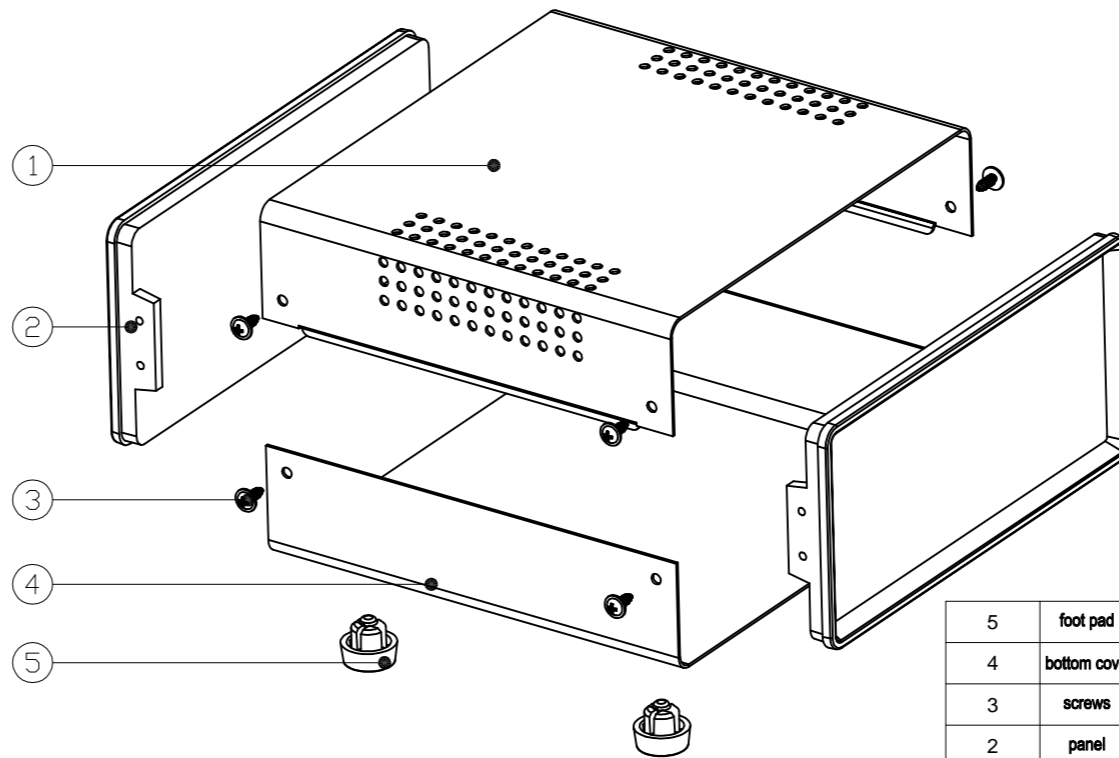

5	foot pad	TPE	4	BP-16	
4	bottom cover	Electrolytic sheet	1	40004-W140-C1	0.8MM
3	screws	STD	8	PWA3X8	
2	panel	ABS	2	40004-A1	
1	Uppre cover	Electrolytic sheet	1	40004-W140-B1	0.8MM
Drawing	Auditing	Confirm	Product Name	Metal Enclosure	Project View
			Product Type	BDA 40004 (W140)	Drawing Scale
					1:1 (MM)

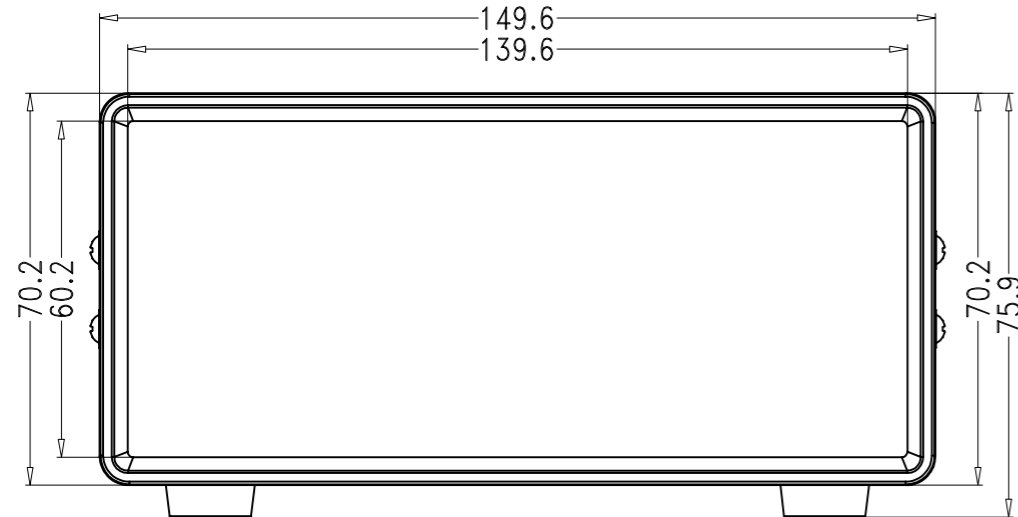

BAHAR ENCLOSURE GmbH