

SECTION B-B

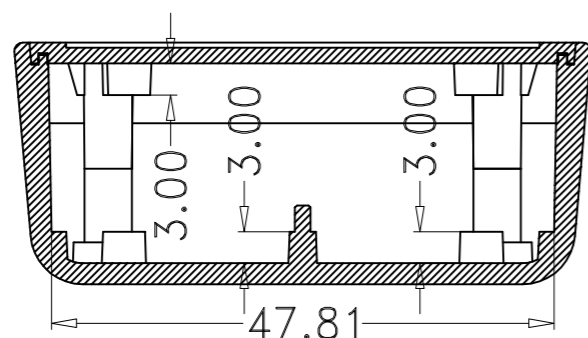

SECTION A-A

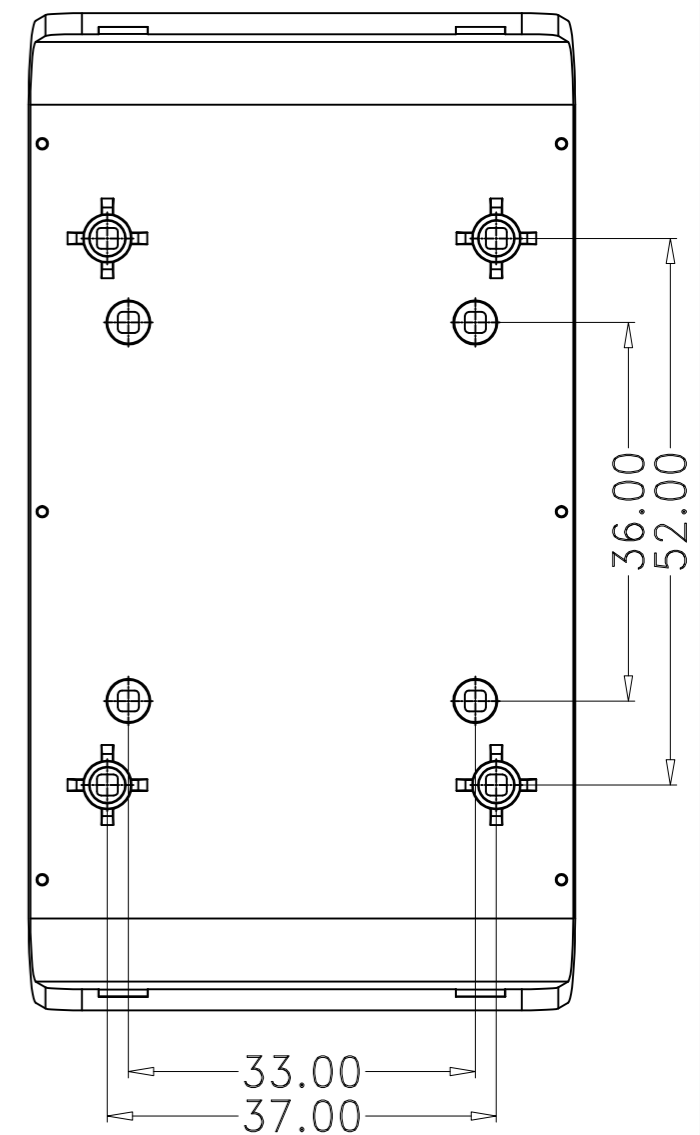
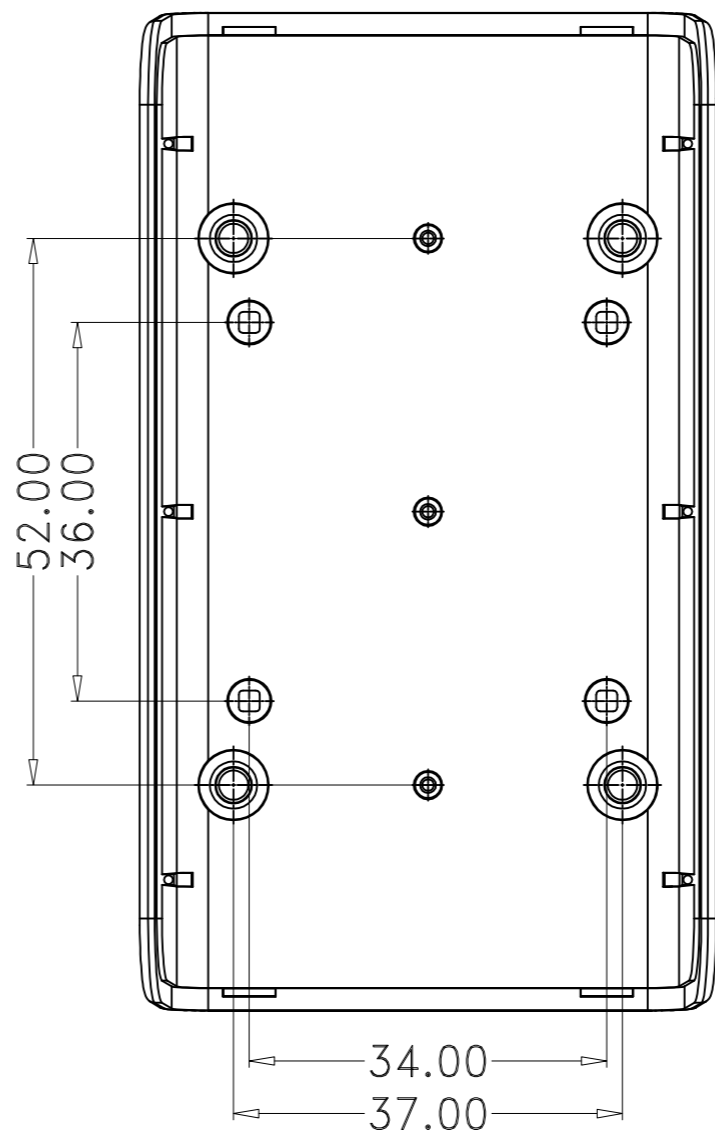
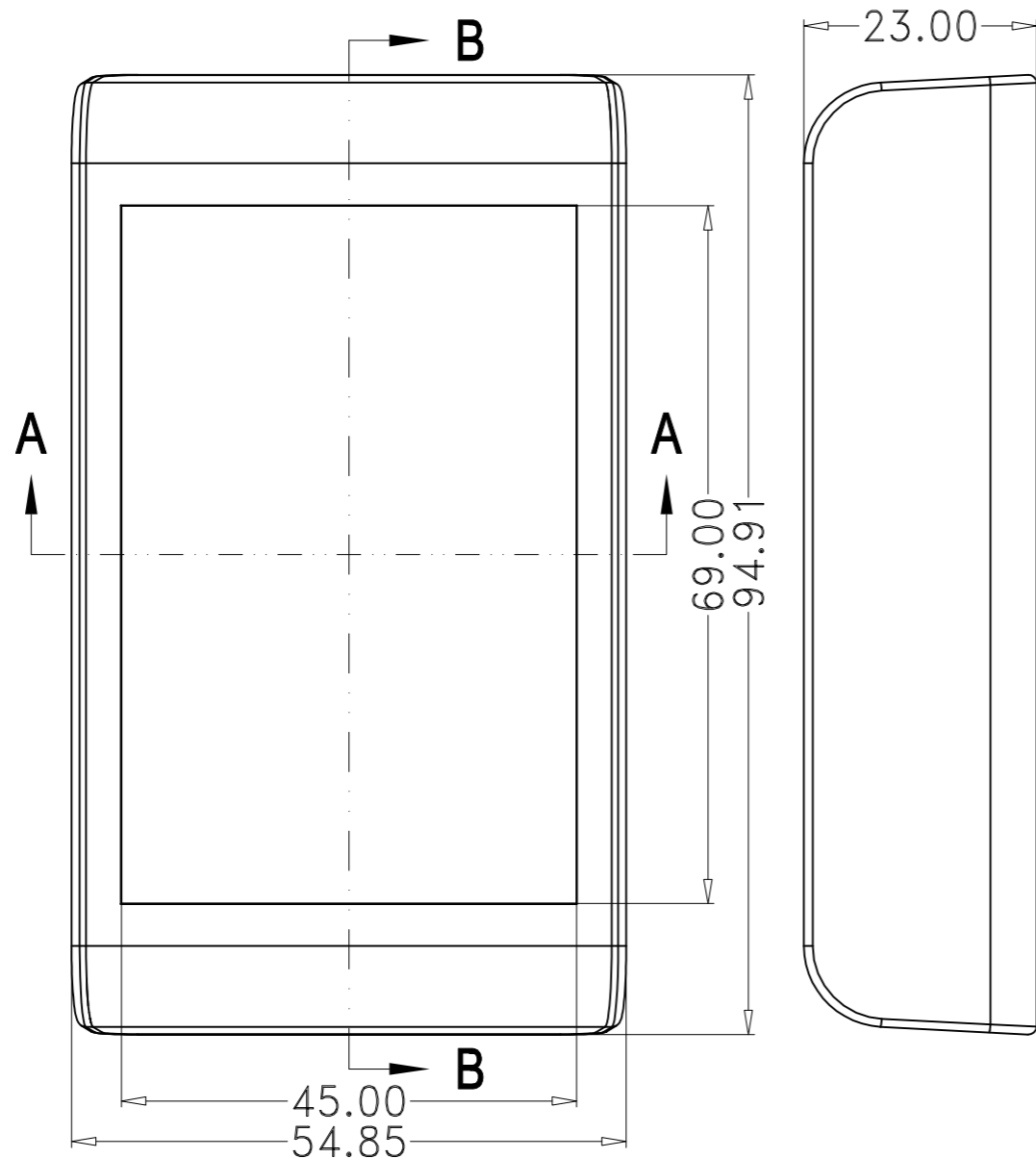
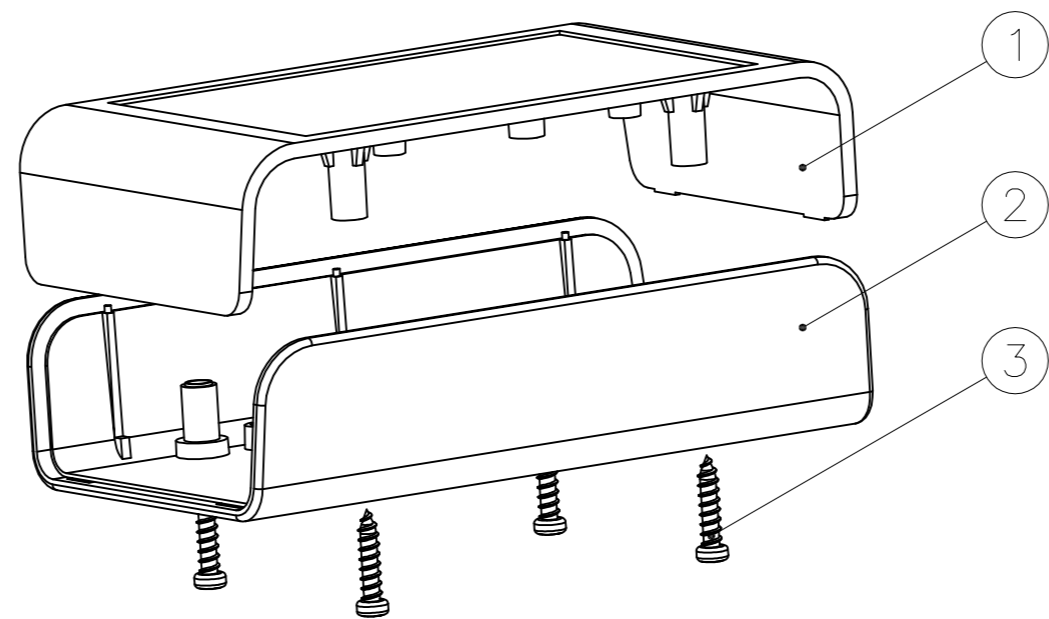

3	screws	STD	4	PA2.5X16			
2	bottom cover	ABS	1	60002-B1			
1	Uppre cover	ABS	1	60002-A1			
Drawing	Auditing	Confirm	Product Name	Desk-top Enclosure	Project View		A
			Product Type	BMD 60002	Drawing Scale	1:1 (MM)	