

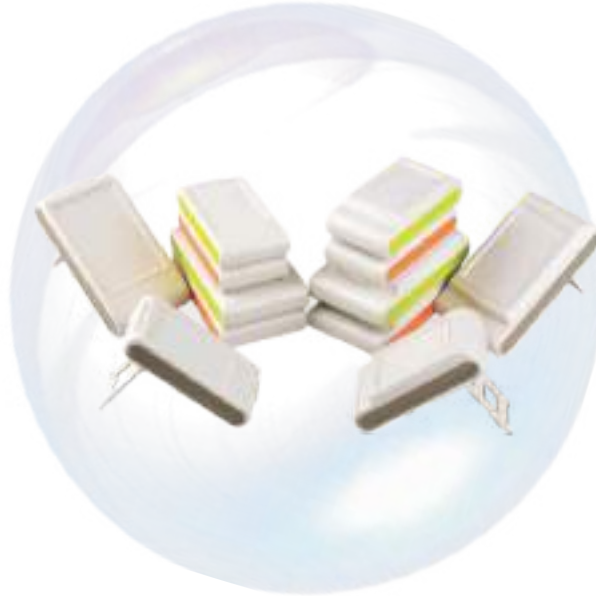

巴哈尔壳体

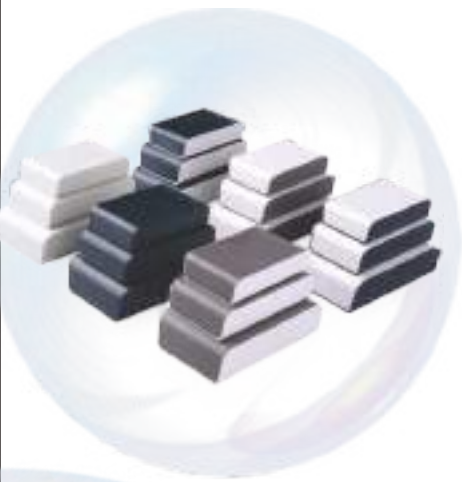

PRODUCTS

Mould Making
Enclosure





Bahar Enclosure GmbH

Hindenburgstraße 165
22297 Hamburg-GERMANY
Tel: +49 (0) 40 2260 55 - 90
Fax: +49 (0) 40 2260 55 - 92
Salesmanager (Hamburg)E-mail:
sales@bahar.asia

巴哈尔壳体（深圳）有限公司

Bahar Enclosure (shen zhen) Co.,Ltd

工厂地址：

广东深圳市宝安区沙井街道新玉路北侧
圣佐治工业园7A

Factory address:

7A Building, ShengZuoZhi Industrial
Park,Xin Yu North Road,Sha Jing Street,
Bao'an District,Shen Zhen,Guang Dong
Province,China

Tel:+86 755 36650823-820 33262000

Fax:+86 755 33262020

E-mail:info@bahar.asia

店铺地址：

广东深圳市福田区华强北路1002号赛格
广场2楼2242号

Shop address:

No.2242 2F SEG Plaza,1002 HuaQiang
North Road,Futian District,ShenZhen,
Guang Dong Province,China

Tel:+86 4000000941

北京地址：

北京市海淀区知春路118号知春大厦C座
3层30178室

Room 30178, Block C, Zhichun Tower, 118
ZhiChunLu, Haidian District, Beijing, China

Tel:+86 400 000 1093 (010)64787103

www.bahar.asia

公司简介

巴哈尔壳体有限公司成立于2010年1月，厂房占地面积6千多平方米，巴哈尔壳体是一家集模具设计、产品研发、生产、销售为一体的德国设计中国制造的外资企业。致力于各类电子产品外壳的设计与制造，为广大客户提供领先的模具制造、五金、塑胶、铝合金壳体等解决方案。产品主要包括：塑料防水盒、台式仪表盒、壁挂式仪表盒、便携式仪表盒、工控盒、铝外壳、铁外壳和塑料密封箱等。

一直以来，公司把产品质量视为企业生存的根本，以技术创新求发展。现已拥有一个良好的管理和销售团队及一批精良的机械设备，为开发高精度模具和高档次产品提供了有力保证。凭借不断增强的行业技术创新、高效的供应链和强大的团队合作精神，产品已行销至国内外并赢得全球不同行业客户的信赖与合作。在此诚挚地欢迎国内外客商与我们携手合作，共同发展。

Bahar Enclosure Co.,Ltd was founded in January 2010, plant covers an area of 6 thousand square meters, Bahar Enclosure is a mold design, product development, production, sales for the integration of German design and manufactured in china of foreign enterprises. It is dedicated to the design and manufacture of various electronic product covers, we provide our customers with leading solution in mold manufacturing, metal, plastic, aluminum case etc. Products mainly include: plastic waterproof enclosure, desk type instrument enclosure, wall mounted instrument enclosure, portable instrument enclosure, industrial control enclosure, aluminum housings, iron housings and plastic seal enclosure, etc.

The Company has always regarded product quality as the fundamental of the survival, strives for development by technical innovation. Currently, the Company boasts a good management and sales team and a lot of sophisticated machinery and equipment for the development of high-precision and high-grade products to provide a strong guarantee. Relying on the ever-increasing technical in the industry, efficient supply chain and strong team spirit, our products have been sold around the world and won the trust and cooperation of customers in different industries. Here, we sincerely welcome domestic and foreign businessmen to cooperate with us, common development.



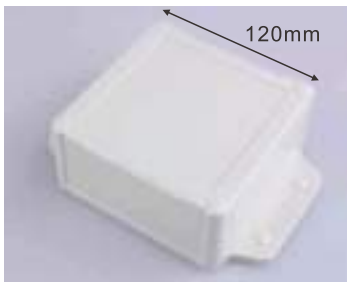

BWP 10001-A1
120*168*55mm



BWP 10001-A2
120*168*55mm



BWP 10002-A1
200*94*45mm

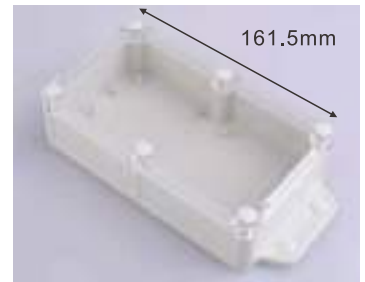

BWP 10002-A2
200*94*45mm



BWP 10003-A1
200*94*60mm



BWP 10003-A2
200*94*60mm

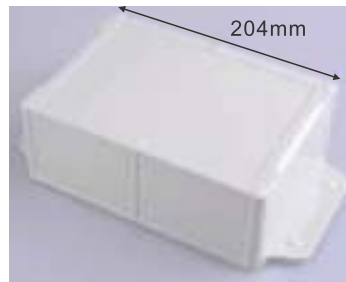

BWP 10008-A1
260*143*75mm



BWP 10008-A2
260*143*75mm

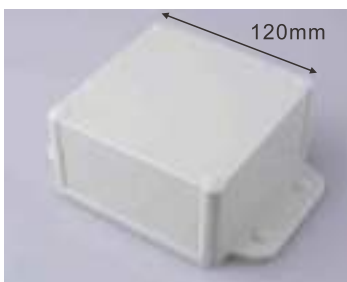

BWP 10011-A1
168*120*61mm



BWP 10011-A2
168*120*61mm



BWP 10012-A1
200*94*51mm



BWP 10012-A2
200*94*51mm



162mm

BWP 10013-A1
200*94*66mm



162mm

BWP 10013-A2
200*94*66mm



102mm

BWP 10014-A1
128*70*52mm



102mm

BWP 10014-A2
128*70*52mm

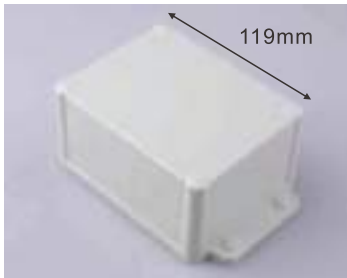

119mm

BWP 10015-A1
148*94*60mm

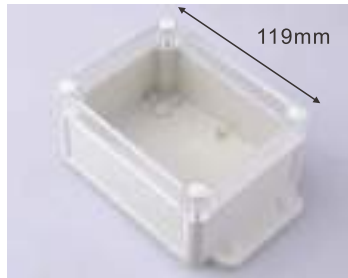

119mm

BWP 10015-A2
148*94*60mm



144mm

BWP 10016-A1
173*85*51mm



144mm

BWP 10016-A2
173*85*51mm

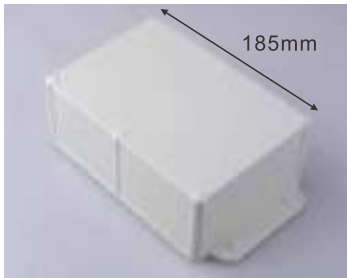

185mm

BWP 10017-A1
224*129*70mm



185mm

BWP 10017-A2
224*129*70mm

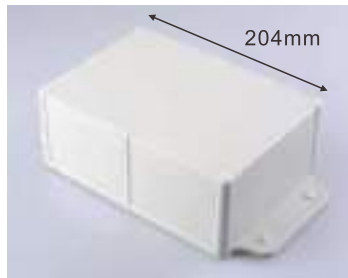

204mm

BWP 10018-A1
260*143*78mm



204mm

BWP 10018-A2
260*143*78mm

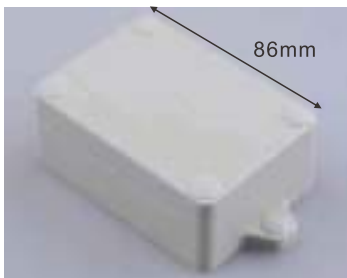

86mm

BWP 10019-A1
111*62*33mm

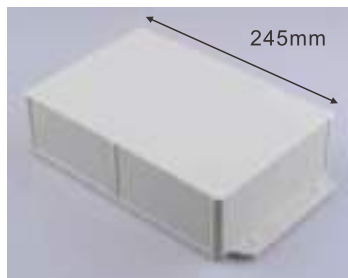

245mm

BWP 10020-A1
283*165*66mm



245mm

BWP 10020-A2
283*165*66mm

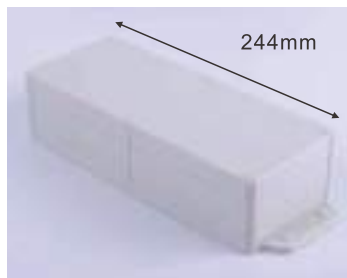

244mm

BWP 10021-A1
283*100*59mm

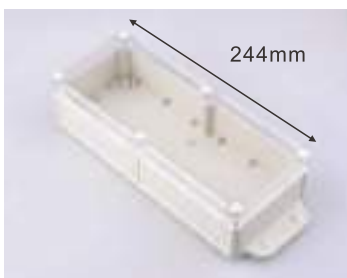

244mm

BWP 10021-A2
283*100*59mm

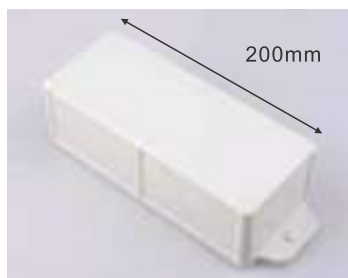

200mm

BWP 10022-A1
238*84*60mm

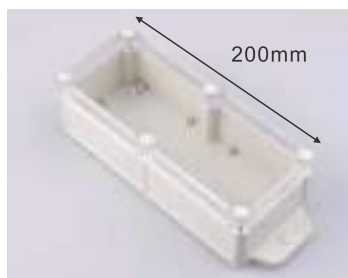

200mm

BWP 10022-A2
238*84*60mm

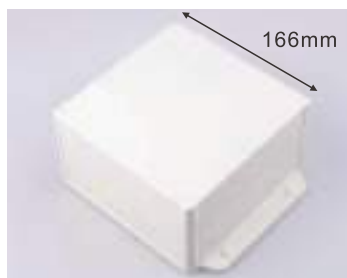

166mm

BWP 10023-A1
204*166*91mm



BWP 10023-A2
204*166*91mm

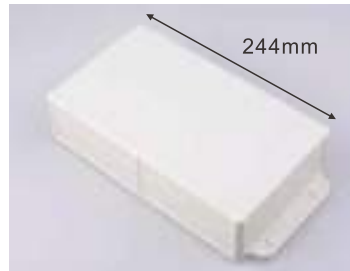

BWP 10024-A1
282*142*59mm



BWP 10024-A2
282*142*59mm

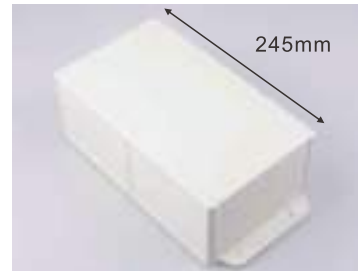

BWP 10025-A1
283*143*89mm

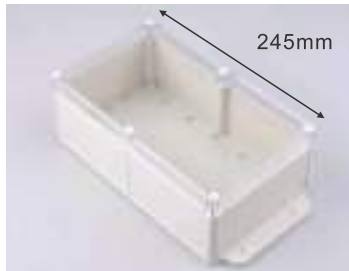

BWP 10025-A2
283*143*89mm



BWP 10501-A1
120*120*55mm



BWP 10501-A2
120*120*55mm



BWP 10502-A1
161.5*94*45mm



BWP 10502-A2
161.5*94*45mm



BWP 10503-A1
162*94*60mm



BWP 10503-A2
162*94*60mm



BWP 10508-A1
204*143*75mm



BWP 10508-A2
204*143*75mm



BWP 10511-A1
120*120*61mm



BWP 10511-A2
120*120*61mm



BWP 10512-A1
161.5*94*51mm



BWP 10512-A2
161.5*94*51mm



BWP 10513-A1
162*94*66mm



BWP 10513-A2
162*94*66mm



BWP 10514-A1
102*70*52mm



BWP 10514-A2
102*70*52mm



BWP 10515-A1
119*94*60mm



BWP 10515-A2
119*94*60mm



BWP 10516-A1
144*85*51mm



BWP 10516-A2
144*85*51mm



BWP 10517-A1
185*129*70mm



BWP 10517-A2
185*129*70mm



BWP 10518-A1
204*143*78mm



BWP 10518-A2
204*143*78mm



BWP 10520-A1
245*165*66mm



BWP 10520-A2
245*165*66mm



BWP 10521-A1
244*100*59mm



BWP 10521-A2
244*100*59mm



BWP 10522-A1
200*84*60mm



BWP 10522-A2
200*84*60mm



BWP 10523-A1
166*166*91mm



BWP 10523-A2
166*166*91mm



BWP 10524-A1
244*142*59mm



BWP 10524-A2
244*142*59mm



BWP 10525-A1
245*143*89mm



BWP 10525-A2
245*143*89mm

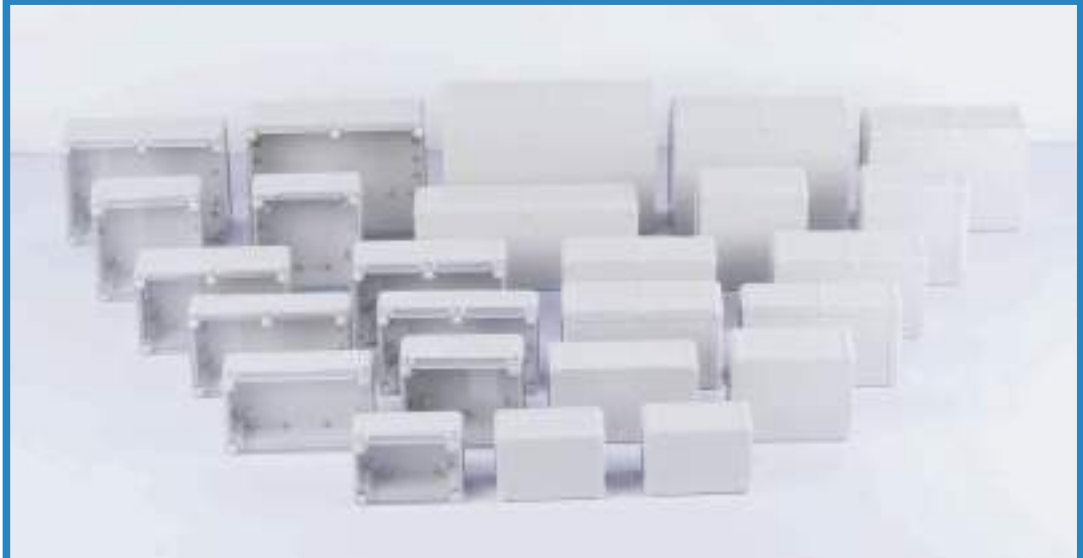

BWP 10601-A1
251*177*100mm



BWP 10601-A2
251*177*100mm



BWP 10602-A1
268*198*102mm



BWP 10602-A2
268*198*102mm



BWP 10603-A1
331*256*77mm



BWP 10603-A2
331*256*77mm



BWP 10604-A1
331*256*109mm



BWP 10604-A2
331*256*109mm

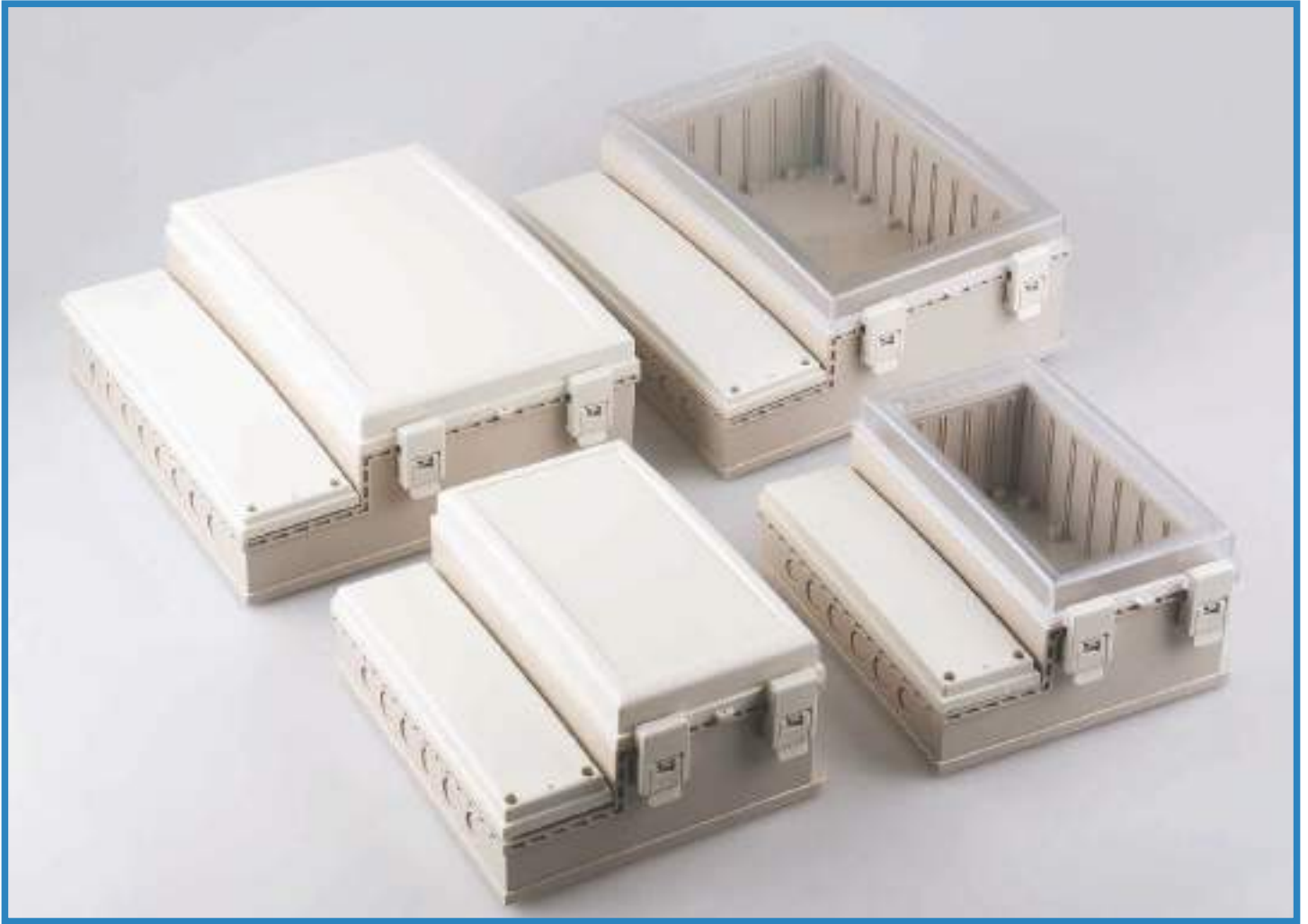

BWP 10801-A1
291*301*120mm

BWP 10801-A2
291*301*120mm

BWP 10802-A1
228*206*113mm

BWP 10802-A2
228*206*113mm



BDH 20001-A1
105*75*36mm



BDH 20001-A2
105*75*36mm



BDH 20002-A1
135*90*45mm



BDH 20002-A2
135*90*45mm



BDH 20003-A1
164*100*50mm



BDH 20003-A2
164*100*50mm



BDH 20005-A1
105*75*36mm



BDH 20005-A2
105*75*36mm



BDH 20006-A1
135*90*45mm



BDH 20006-A2
135*90*45mm



BDH 20007-A1
164*100*50mm



BDH 20007-A2
164*100*50mm



BDH 20009-A1
140*170*60mm



BDH 20009-A2
140*170*60mm



BDH 20010-A1
160*130*48mm



BDH 20010-A2
160*130*48mm



BDH 20011-A1
175*210*65mm



BDH 20011-A2
175*210*65mm



BDH 20012-A1
180*140*60mm



BDH 20012-A2
180*140*60mm



BDH 20013-A1
200*190*76mm



BDH 20013-A2
200*190*76mm



BDH 20014-A1
230*210*86mm



BDH 20014-A2
230*210*86mm



BDH 20015-A1
260*220*80mm



BDH 20015-A2
260*220*80mm



BDH 20016-A1
290*260*80mm



BDH 20016-A2
290*260*80mm



BDH 20009-A1



BDH 20016-A1



BDC 30001-A1
156*114*77mm



BDC 30001-A2
156*114*77mm



BDC 30001-A3
156*114*77mm



BDC 30002-A1
200*145*60mm



BDC 30003-A1
200*145*60mm



BDC 30004-A1
218*144*59mm



BDC 30005-A1
200*145*70mm



BDC 30006-A1
121*140*35mm



BDC 30007-A1
121*140*35mm



BDC 30007-A2
121*140*35mm



BDC 30008-A1
275*204*97mm



BDC 30009-A1
108*152*54mm

BDC 30009-A2
108*152*54mm



BDC 30010-A1
108*152*54mm



BDC 30010-A2
108*152*54mm



70*33mm

BDC 30011-A1
108*152*52mm



BDC 30012-A1
210*140*42mm



BDC 30013-A1
210*140*42mm



BDC 30013-A2
210*140*42mm



BMW 50001-A1
110*70*38mm



BMW 50001-A2
110*70*38mm



BMW 50002-A1
200*145*60mm



BMW 50003-A1
145*200*60mm



BMW 50004-A1
200*145*56mm



BMW 50005-A1
210*139*55mm



BMW 50006-A1
168*107*42mm



BMW 50007-A1
130*89*31mm



BMW 50008-A1
155*80*45mm



BMW 50008-A2
155*80*45mm



BMW 50009-A1
145*85*40mm



BMW 50009-A2
145*85*40mm



BMW 50010-A1
120*60*35mm



BMW 50010-A2
120*60*35mm



BMW 50011-A1
110*70*40mm



BMW 50011-A2
110*70*40mm



BMW 50012-A1
105*65*40mm



BMW 50012-A2
105*65*40mm



BMW 50013-A1
85*55*35mm



BMW 50013-A2
85*55*35mm



BMW 50014-A1
80*75*45mm



BMW 50014-A2
80*75*45mm



BMW 50015-A1
70*50*40mm



BMW 50015-A2
70*50*40mm



BMW 50016-A1
275*204*64mm



BMW 50017-A1
108*152*54mm



BMW 50017-A2
108*152*54mm



BMW 50018-A1
108*152*36mm



BMW 50018-A2
108*152*36mm



BMW 50019-A1
104*210*44mm



BMW 50020-A1
125*67*40mm



BMW 50020-A3
125*67*40mm



BMW 50021-A1
36*36*15mm



BMW 50021-A2
36*36*15mm



BMW 50022-A1
36*36*20mm



BMW 50022-A2
36*36*20mm



BMW 50023-A1
41*41*15mm



BMW 50023-A2
41*41*15mm



BMW 50024-A1
41*41*20mm



BMW 50024-A2
41*41*20mm



BMW 50025-A1
51*36*15mm



BMW 50025-A2
51*36*15mm



BMW 50026-A1
51*36*20mm



BMW 50026-A2
51*36*20mm



BMW 50027-A1
51*51*15mm



BMW 50027-A2
51*51*15mm



BMW 50028-A1
51*51*20mm



BMW 50028-A2
51*51*20mm



BMW 50029-A1
61*36*15mm



BMW 50029-A2
61*36*15mm



BMW 50030-A1
61*36*20mm



BMW 50030-A2
61*36*20mm



BMW 50031-A1
81*41*15mm



BMW 50031-A2
81*41*15mm



BMW 50032-A1
81*41*20mm



BMW 50032-A2
81*41*20mm



BMD 60001-A1
80*50*19mm



BMD 60001-A2
80*50*19mm



BMD 60001-A6
80*50*19mm

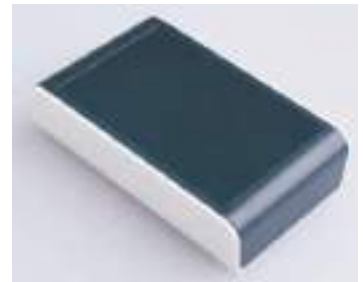

BMD 60001-A8
80*50*19mm



BMD 60001-A9
80*50*19mm



BMD 60001-A11
80*50*19mm



BMD 60002-A1
95*55*23mm

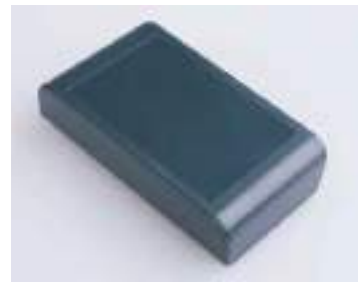

BMD 60002-A2
95*55*23mm



BMD 60002-A6
95*55*23mm

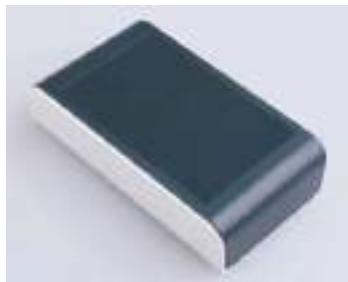

BMD 60002-A8
95*55*23mm



BMD 60002-A9
95*55*23mm



BMD 60002-A11
95*55*23mm

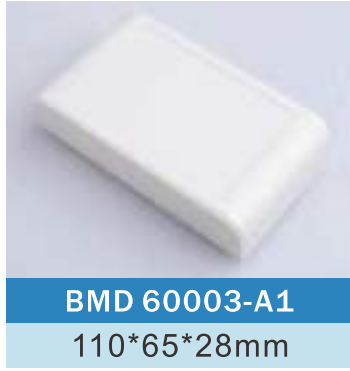

BMD 60003-A1
110*65*28mm

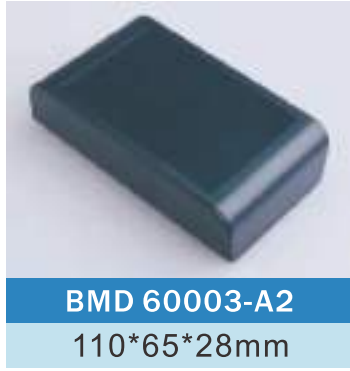

BMD 60003-A2
110*65*28mm

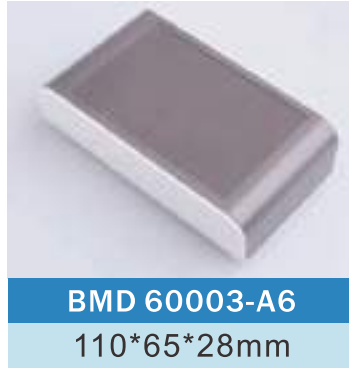

BMD 60003-A6
110*65*28mm

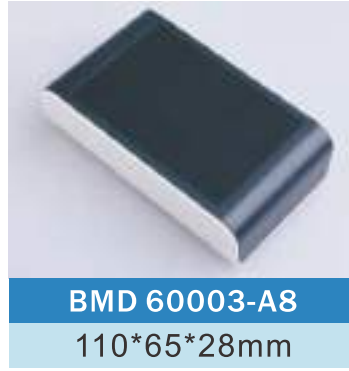

BMD 60003-A8
110*65*28mm

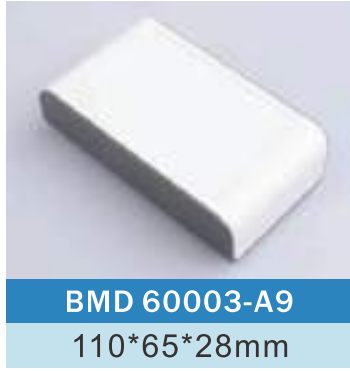

BMD 60003-A9
110*65*28mm

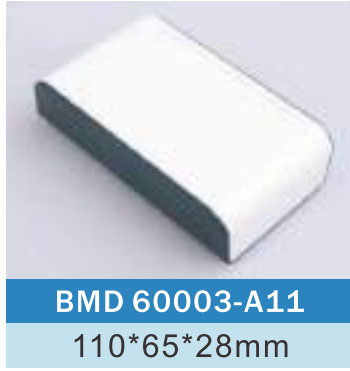

BMD 60003-A11
110*65*28mm



BMD 60004-A1
155*80*45mm



BMD 60004-A2
155*80*45mm



BMD 60005-A1
145*85*40mm

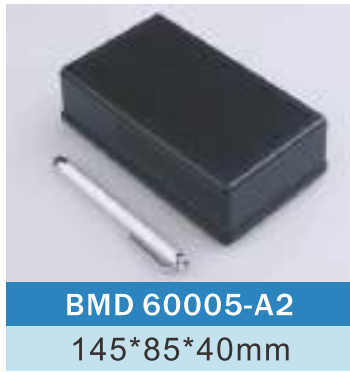

BMD 60005-A2
145*85*40mm



BMD 60006-A1
120*60*35mm



BMD 60006-A2
120*60*35mm



BMD 60007-A1
110*70*40mm



BMD 60007-A2
110*70*40mm



BMD 60008-A1
105*65*40mm



BMD 60008-A2
105*65*40mm



BMD 60009-A1
85*55*35mm



BMD 60009-A2
85*55*35mm



BMD 60010-A1
80*75*45mm



BMD 60010-A2
80*75*45mm

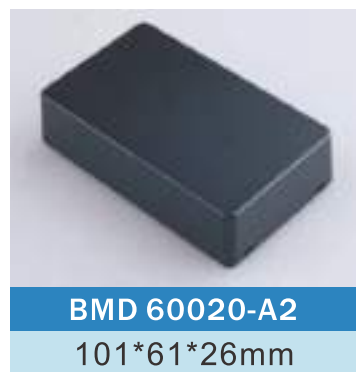
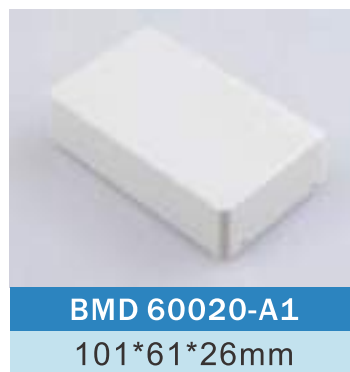
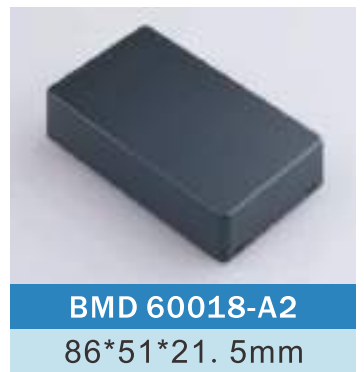
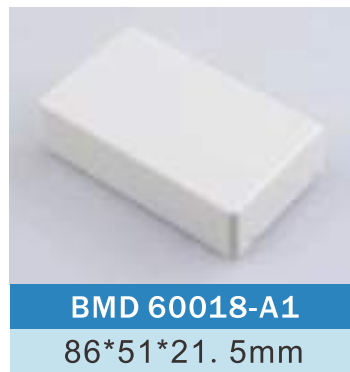
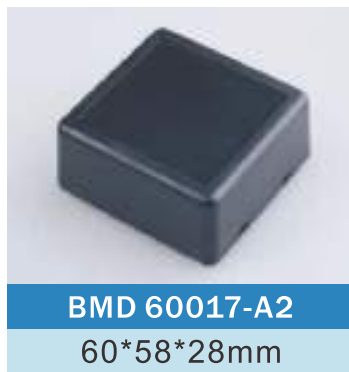
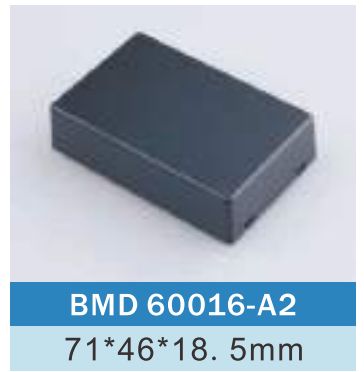
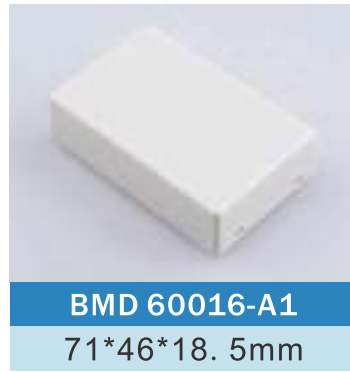
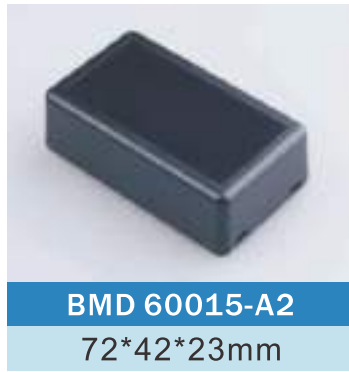
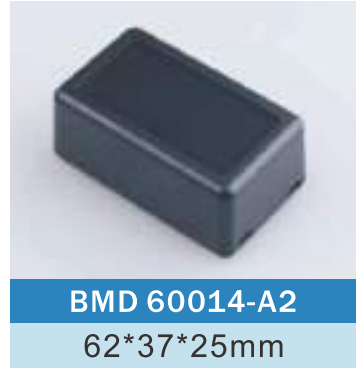
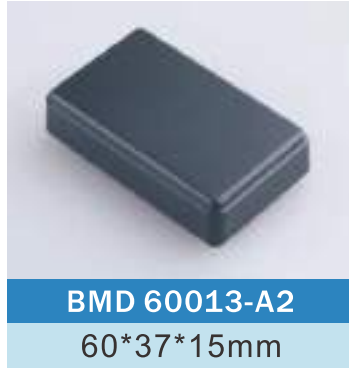
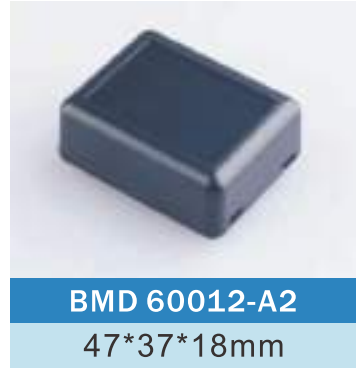



BMD 60021-A1
121*58*32mm



BMD 60021-A2
121*58*32mm



BMD 60022-A1
36*36*15mm



BMD 60022-A2
36*36*15mm



BMD 60023-A1
36*36*20mm



BMD 60023-A2
36*36*20mm



BMD 60024-A1
41*41*15mm



BMD 60024-A2
41*41*15mm



BMD 60025-A1
41*41*20mm



BMD 60025-A2
41*41*20mm



BMD 60026-A1
51*36*15mm



BMD 60026-A2
51*36*15mm



BMD 60027-A1
51*36*20mm



BMD 60027-A2
51*36*20mm



BMD 60028-A1
51*51*15mm



BMD 60028-A2
51*51*15mm



BMD 60029-A1
51*51*20mm



BMD 60029-A2
51*51*20mm



BMD 60030-A1
61*36*15mm



BMD 60030-A2
61*36*15mm



BMD 60031-A1
61*36*20mm



BMD 60031-A2
61*36*20mm



BMD 60032-A1
81*41*15mm



BMD 60032-A2
81*41*15mm



BMD 60033-A1
81*41*20mm



BMD 60033-A2
81*41*20mm



BMD 60034-A1
37*112*25mm



BMD 60034-A2
37*112*25mm



BMD 60035-A1
68*90*28mm



BMD 60035-A2
68*90*28mm



BMD 60036-A1
77*110*25mm



BMD 60036-A2
77*110*25mm



BMD 60037-A1
68*139*28mm



BMD 60037-A2
68*139*28mm





BMC 70001-A1
72*38.5*15mm



BMC 70001-A2
72*38.5*15mm



BMC 70001-A3
72*38.5*15mm



BMC 70001-A4
72*38.5*15mm



BMC 70001-A5
72*38.5*15mm



BMC 70001-A6
72*38.5*15mm



BMC 70001-A7
72*38.5*15mm



BMC 70001-A8
72*38.5*15mm



BMC 70001-A9
72*38.5*15mm



BMC 70001-A10
72*38.5*15mm





BMC 70002-A1
238*134*58mm



BMC 70002-B1
238*134*58mm



BMC 70002-C1
238*134*58mm



BMC 70005-A1
152*108*36mm



BMC 70002



BMC 70005-A2
152*108*36mm



BMC 70006-A2
220*118*101mm



BMC 70009-A1
238*134*50mm



BMC 70010-A1
210*104*44mm



BMC 70007-A1
171*98*31mm



BMC 70007-A3
171*98*31mm



BMC 70007-A4
171*98*31mm



BMC 70008-A1
171*98*41mm



BMC 70008-A3
171*98*41mm



BMC 70008-A4
171*98*41mm



BMC 70011-A1
141*76*28mm



BMC 70011-A3
141*76*28mm



BMC 70011-A4
141*76*28mm



BMC 70012-A1
141*76*36mm



BMC 70012-A3
141*76*36mm



BMC 70012-A4
141*76*36mm



BMC 70019-A1
80*60*24mm



BMC 70019-A2
80*60*24mm



BMC 70020-A1
105*60*24mm



BMC 70020-A2
105*60*24mm



BMC 70021-A1
130*60*24mm



BMC 70021-A2
130*60*24mm





BMC 70022-A1
160*60*24mm



BMC 70022-A2
160*60*24mm



BMC 70019-B1+BT
80*60*24mm



BMC 70019-B2+BT
80*60*24mm



BMC 70020-B1+BT
105*60*24mm



BMC 70020-B2+BT
105*60*24mm



BMC 70021-B1+BT
130*60*24mm



BMC 70021-B2+BT
130*60*24mm



BMC 70022-B1+BT
160*60*24mm



BMC 70022-B2+BT
160*60*24mm





BMC 70019-B1

80*60*24mm



BMC 70019-B2

80*60*24mm



BMC 70020-B1

105*60*24mm



BMC 70020-B2

105*60*24mm



BMC 70021-B1

130*60*24mm



BMC 70021-B2

130*60*24mm



BMC 70022-B1

160*60*24mm



BMC 70022-B2

160*60*24mm







BRT 80001-A1
36*87*60mm



BRT 80002-A1
53*87*60mm



BRT 80001-B1
36*87*60mm



BRT 80002-B1
53*87*60mm





BRT 80003-A1
72*87*60mm



BRT 80003-A2
72*87*60mm



BRT 80003-B1
72*87*60mm



BRT 80003-A3
72*87*60mm





BRT 80003-B2
72*87*60mm



BRT 80004-A1
106*87*60mm



BRT 80003-B3
72*87*60mm



BRT 80004-B1
106*87*60mm





BRT 80005-A1
158*87*60mm



BRT 80005-A2
158*87*60mm



BRT 80005-B1
158*87*60mm



BRT 80005-A3
158*87*60mm





BRT 80005-B2
158*87*60mm



BRT 80005-B3
158*87*60mm

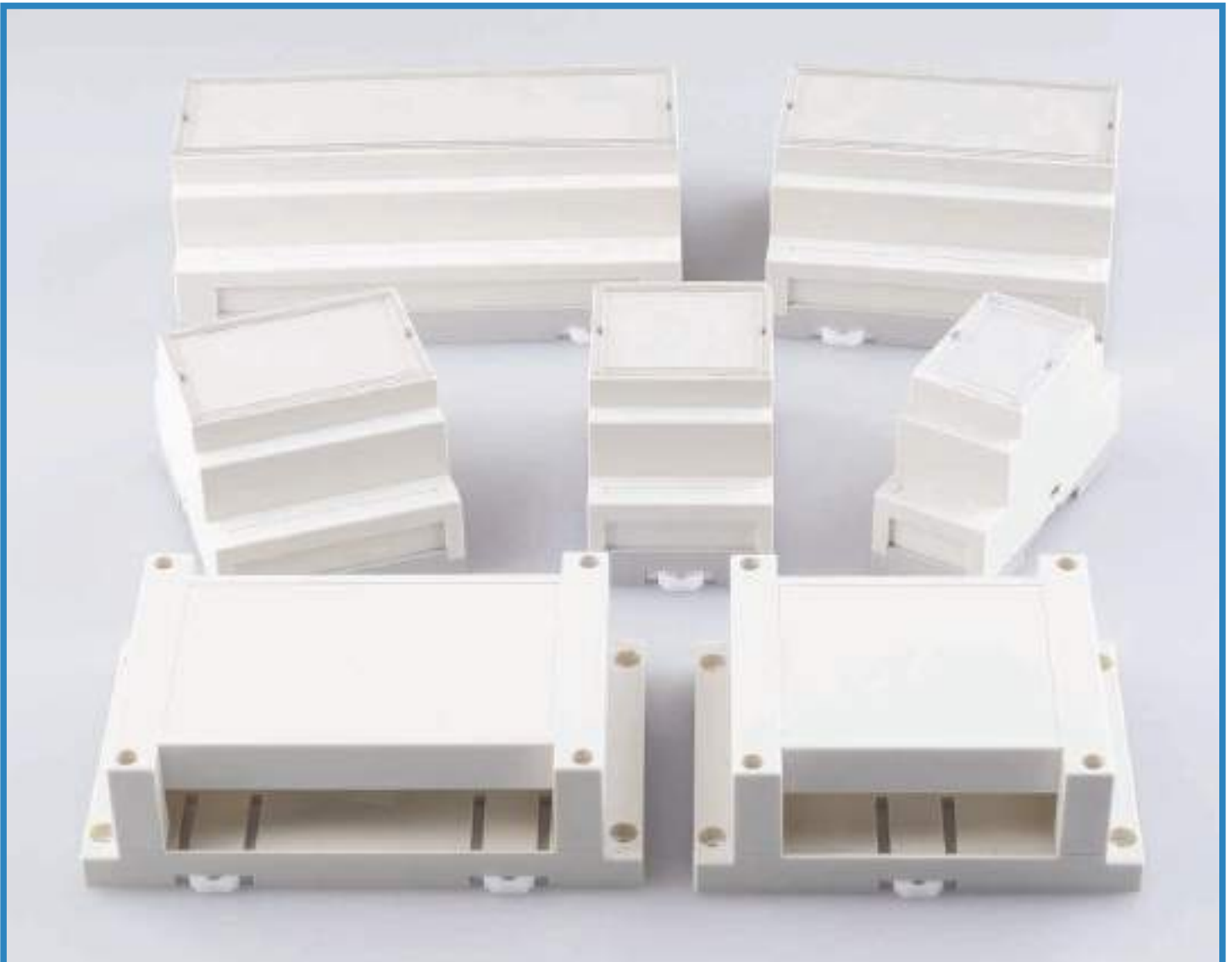



BRT 80006-A1
115*90*40mm



BRT 80007-A1
145*90*40mm



BRT 80008-A1
173.8*138.5*57mm





BRT 80009-A1

108*112*74.8mm



BRT 80010-A1

108*112*55.8mm



BRT 80011-A1

108*112*61.8mm



BEC 18003-A2

341*249*130mm



BEC 18003-A3

341*249*130mm



BEC 18003-A4

341*249*130mm



BEC 18004-A2

341*249*180mm



BEC 18004-A3

341*249*180mm



BEC 18004-A4

341*249*180mm



BAD 11001-A1(W140)

96*33*140mm



BAD 11001-A2(W140)

96*33*140mm



BAD 11001-A3(W140)

96*33*140mm



BAD 11001-A4(W140)

96*33*140mm



BAD 11001-A5(W140)

96*33*140mm



BAD 11001-A6(W140)

96*33*140mm



BAD 11001-A1(W160)

96*33*160mm



BAD 11002-B1(W140)

96*33*140mm

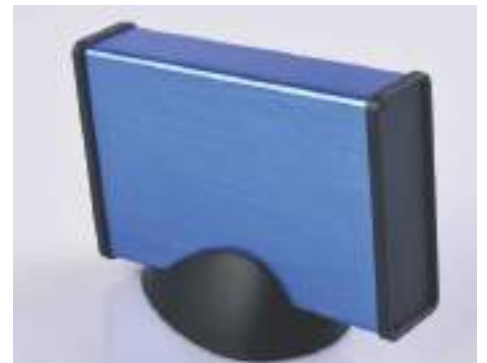

BAD 11002-B3(W140)

96*33*140mm



BAD 11002-B7(W140)

96*33*140mm



BAD 11002-B8(W140)

96*33*140mm



BAD 11003-B1(W120)

76*33*120mm

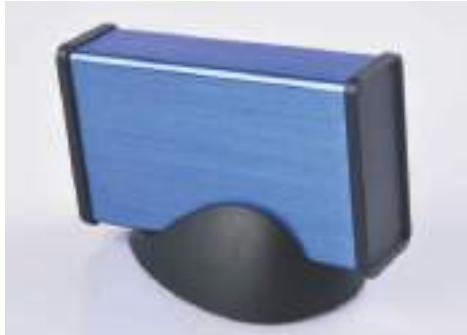

BAD 11003-B3(W120)

73*33*120mm



BAD 11003-B7(W120)

73*33*120mm



BAD 11003-B8(W120)

73*33*120mm



BAD 11004-B1(W160)

124.5*33*160mm



BAD 11004-B7(W160)

124.5*33*160mm



BAD 11004-B8(W160)

124.5*33*160mm



BAD 11005-B1(W90)

61.5*20*90mm



BAD 11005-B3(W90)

61.5*20*90mm



BAD 11005-B7(W90)

61.5*20*90mm



BAD 11005-B8(W90)

61.5*20*90mm



BAD 11006-B1(W100)

63.5*25*100mm

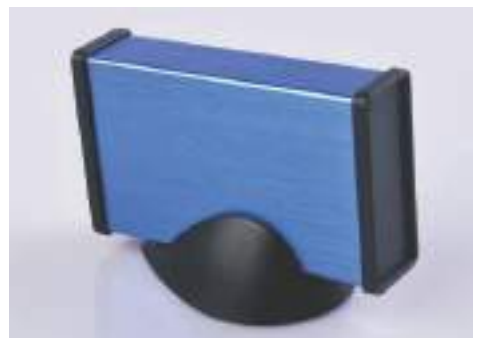

BAD 11006-B3(W100)

63.5*25*100mm



BAD 11006-B7(W100)

63.5*25*100mm



BAD 11006-B8(W100)

63.5*25*100mm



BAD 11007-B1(W140)

84*44*140mm



BAD 11007-B7(W140)

84*44*140mm



BAD 11007-B8(W140)

84*44*140mm



BAD 11008-B1(W180)

124.6*54.5*180mm



BAD 11008-B7(W180)

124.6*54.5*180mm



BAD 11008-B8(W180)

124.6*54.5*180mm



BAD 11009-B1(W160)

110.5*50*160mm



BAD 11009-B7(W160)

110.5*50*160mm



BAD 11009-B8(W160)

110.5*50*160mm



BAD 11010-B1(W160)

96*50*160mm



BAD 11010-B7(W160)

96*50*160mm



BAD 11010-B8(W160)

96*50*160mm



BAD 11011-B1(W220)

165*51*220mm



BAD 11011-B7(W220)

165*51*220mm



BAD 11011-B8(W220)

165*51*220mm



BAD 11012-B1(W220)
165*70*220mm



BAD 11012-B7(W220)
165*70*220mm



BAD 11012-B8(W220)
165*70*220mm



BAD 11013-B1(W220)
185.5*60.5*220mm



BAD 11013-B7(W220)
185.5*60.5*220mm



BAD 11013-B8(W220)
185.5*60.5*220mm



BAD 11014-B1(W180)
124.5*44.5*180mm



BAD 11014-B7(W180)
124.5*44.5*180mm



BAD 11014-B8(W180)
124.5*44.5*180mm



BAD 11015-B1(W200)
145*44.5*200mm



BAD 11015-B7(W200)
145*44.5*200mm



BAD 11015-B8(W200)
145*44.5*200mm



BAD 11017-B1(W275)

200*100*275mm



BAD 11017-B7(W275)

200*100*275mm



BAD 11017-B8(W275)

200*100*275mm



BAD 11017-B1+BTS(W275)

200*100*275mm



BAD 11017-B7+BTS(W275)

200*100*275mm



BAD 11017-B8+BTS(W275)

200*100*275mm



BAD 11018-B1(W220)

100*100*220mm



BAD 11018-B7(W220)

100*100*220mm



BAD 11018-B8(W220)

100*100*220mm



BAD 11019-B1(W220)

126*96*220mm



BAD 11019-B7(W220)

126*96*220mm



BAD 11019-B8(W220)

126*96*220mm



BAD 11020-B7

120*120*275mm

BAD 11020-B8

120*120*275mm



BAD 11020-B1+BTS

120*120*275mm

BAD 11020-B7+BTS

120*120*275mm

BAD 11020-B8+BTS

120*120*275mm



BAD 11021-B1

140*140*275mm

BAD 11021-B7

140*140*275mm

BAD 11021-B8

140*140*275mm



BAD 11021-B1+BTS

140*140*275mm

BAD 11021-B7+BTS

140*140*275mm

BAD 11021-B8+BTS

140*140*275mm



BAD 11022-B7
96*126*220mm



BAD 11022-B8
96*126*220mm



BAD 11023-B1
100*200*275mm



BAD 11023-B7
100*200*275mm



BAD 11023-B8
100*200*275mm



BAD 11023-B1+BTS
100*200*275mm





BAW 12001-A1(W140)

96*33*140mm



BAW 12001-A2(W140)

96*33*140mm



BAW 12001-A3(W140)

96*33*140mm



BAW 12001-A4(W140)

96*33*140mm



BAW 12001-A5(W140)

96*33*140mm



BAW 12001-A6(W140)

96*33*140mm



BAW 12002-B1(W140)

96*33*140mm



BAW 12002-B7(W140)

96*33*140mm



BAW 12002-B8(W140)

96*33*140mm



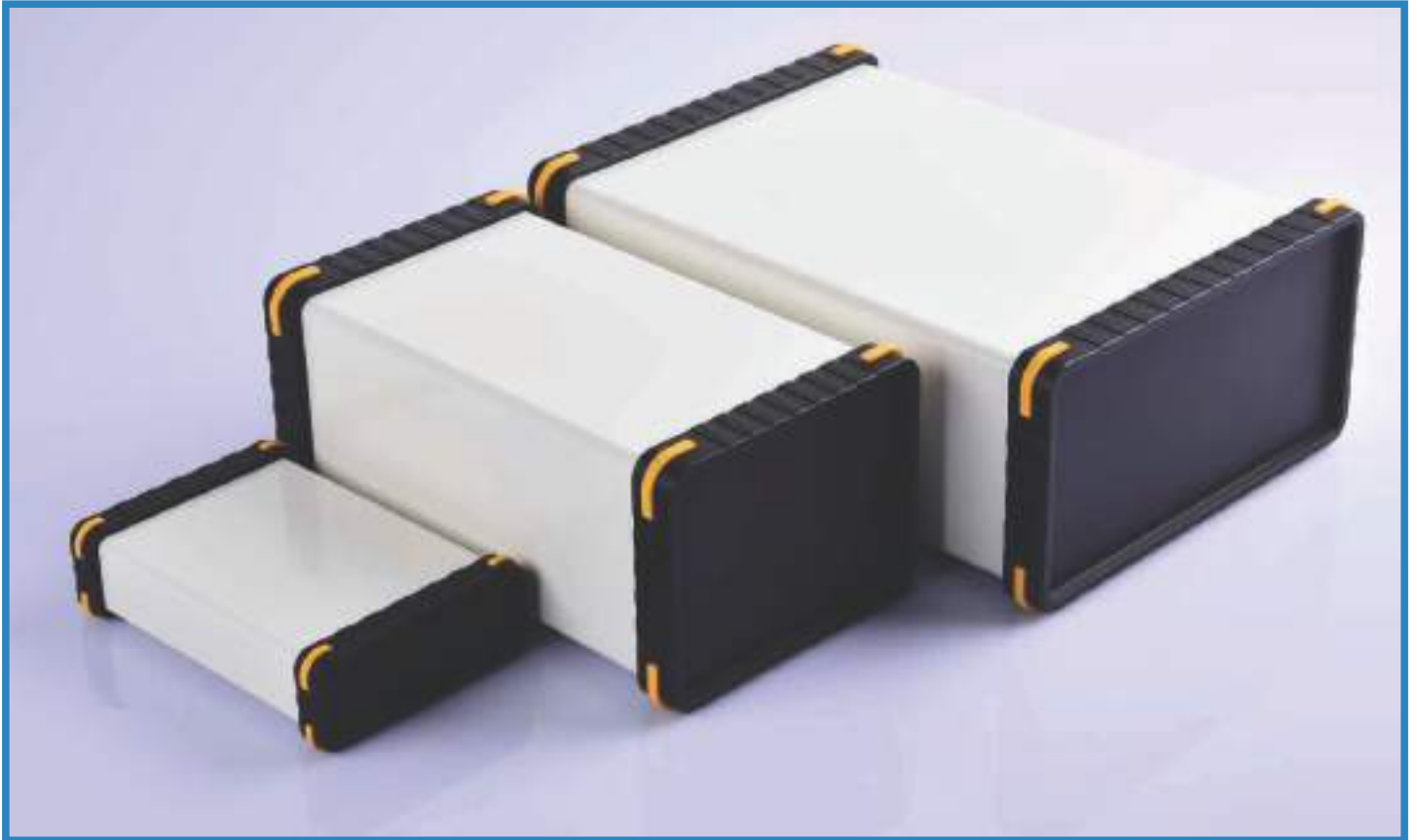

BAD 11002-C1 (W140)

96*33*140mm

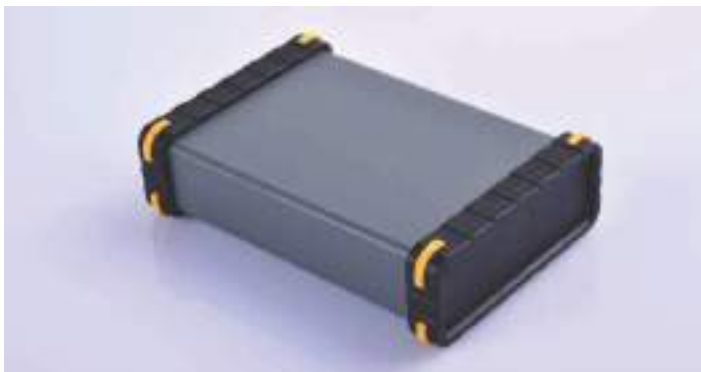

BAD 11002-C7(W140)

96*33*140mm



BAD 11002-C6(W140)

96*33*140mm



BAD 11002-C5(W140)

96*33*140mm

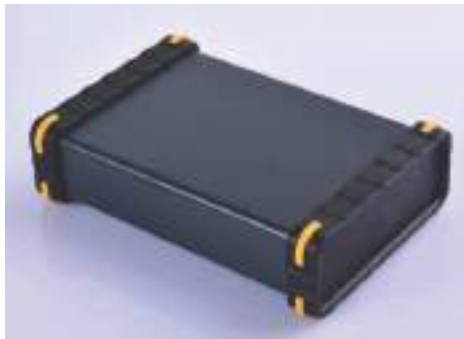

BAD 11002-C2(W140)

96*33*140mm

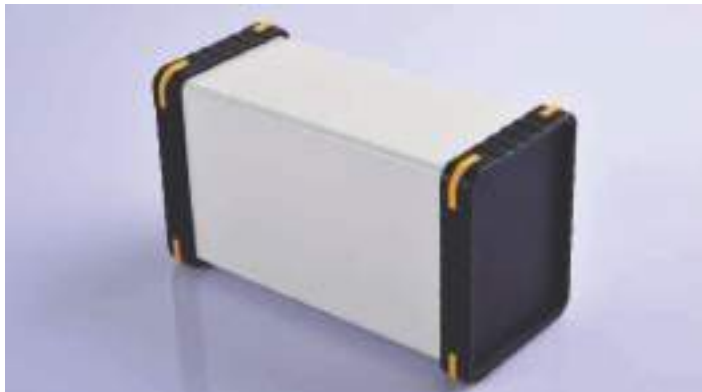

BAD 11019-C1 (W220)

126*96*220mm

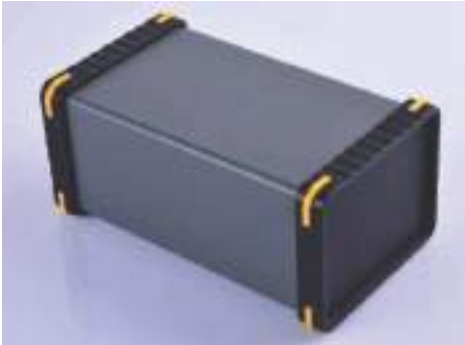

BAD 11019-C7(W220)

126*96*220mm

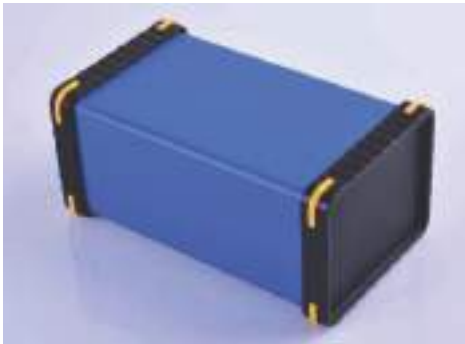

BAD 11019-C6(W220)

126*96*220mm

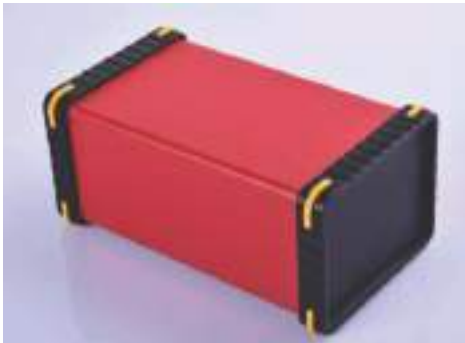

BAD 11019-C5(W220)

126*96*220mm

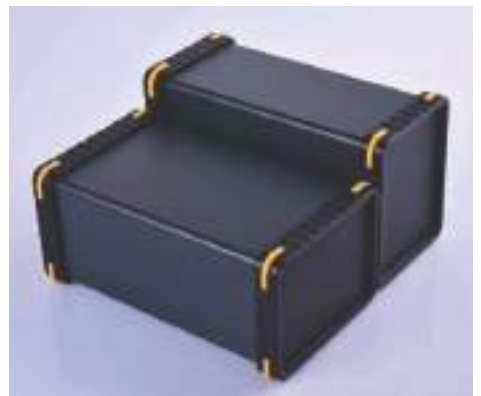
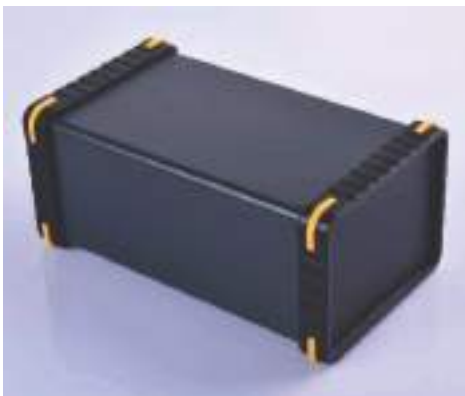

BAD 11019-C2(W220)

126*96*220mm



BAD 11017-C1 (W275)

200*100*275mm

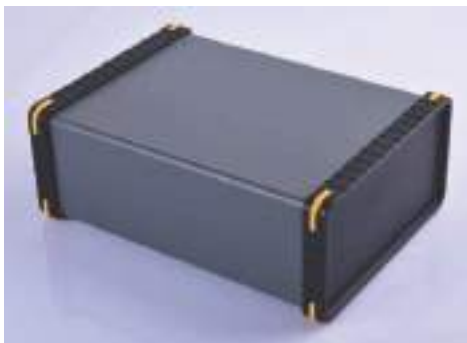

BAD 11017-C7(W275)

200*100*275mm

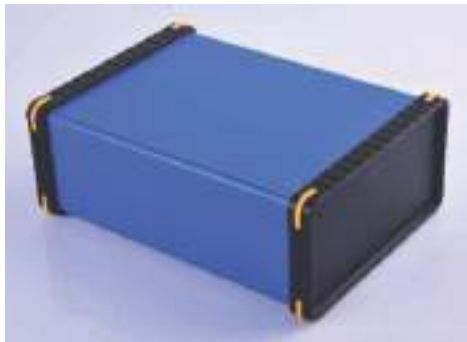

BAD 11017-C6(W275)

200*100*275mm



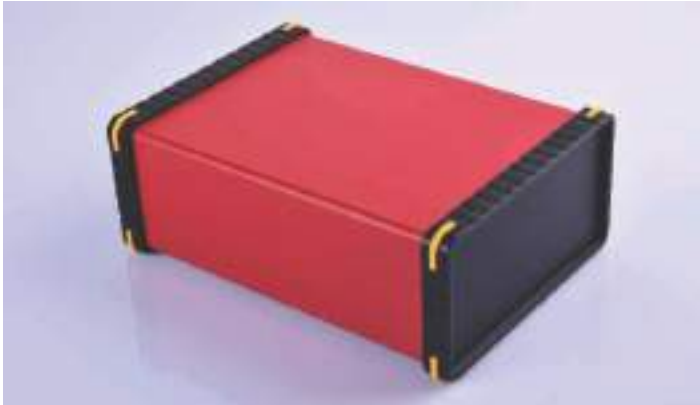

BAD 11017-C5(W275)

200*100*275mm

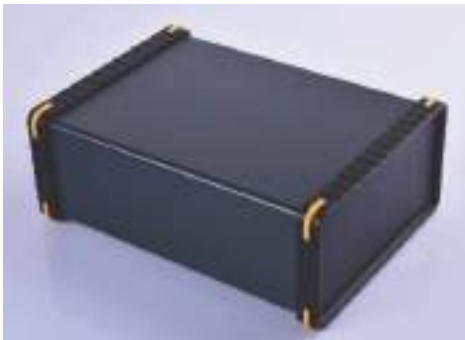

BAD 11017-C2(W275)

200*100*275mm



BAD 11017-C1 (W275)+BTS

200*100*275mm



BAD 11023-C1 (W275)+BTS

200*100*275mm



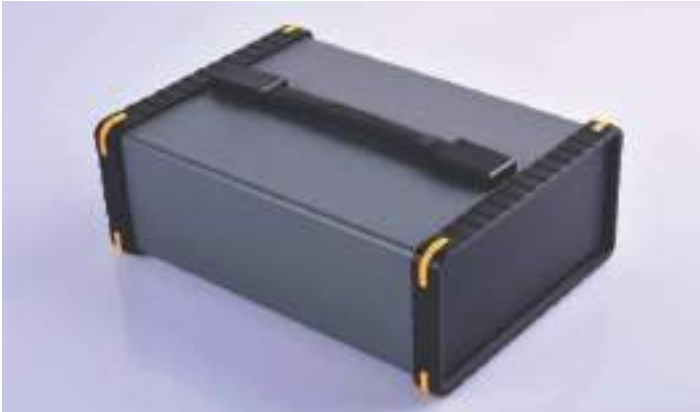

BAD 11017-C7(W275)+BTS 200*100*275mm



BAD 11023-C7(W275)+BTS 200*100*275mm

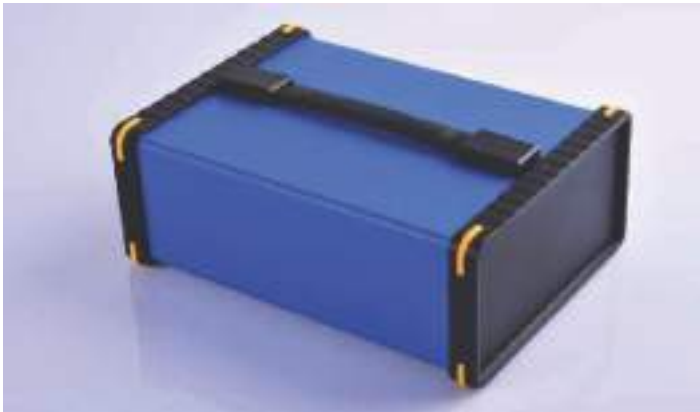

BAD 11017-C6(W275)+BTS 200*100*275mm



BAD 11023-C6(W275)+BTS 200*100*275mm

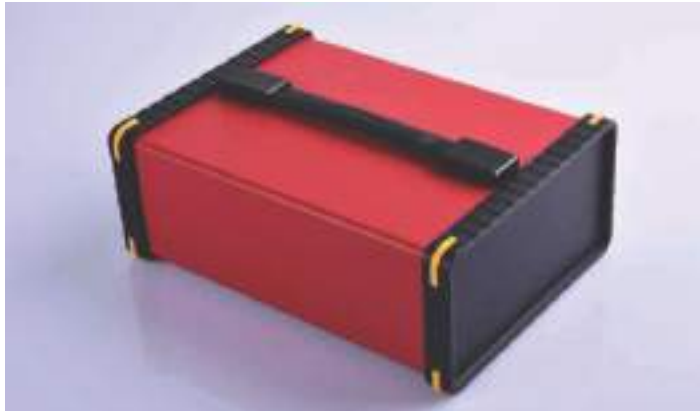

BAD 11017-C5(W275)+BTS 200*100*275mm



BAD 11023-C5(W275)+BTS 200*100*275mm

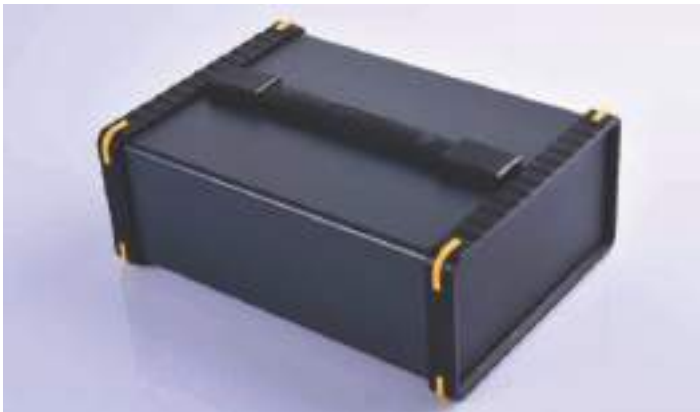

BAD 11017-C2(W275)+BTS 200*100*275mm



BAD 11023-C2(W275)+BTS 200*100*275mm



BAD 11011-C1 (W220)

165*51*220mm



BAD 11011-C2 (W220)

165*51*220mm



BAD 11011-C6 (W220)

165*51*220mm



BAD 11011-C5 (W220)

165*51*220mm



BAD 11012-C1 (W220)

165*70*220mm

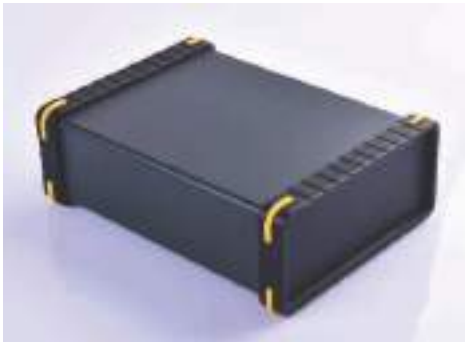

BAD 11012-C2 (W220)

165*70*220mm

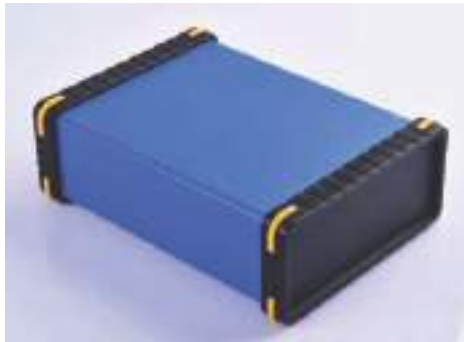

BAD 11012-C6 (W220)

165*70*220mm



BAD 11012-C5 (W220)

165*70*220mm



BAD 11013-C1 (W220)

185.5*60.5*220mm

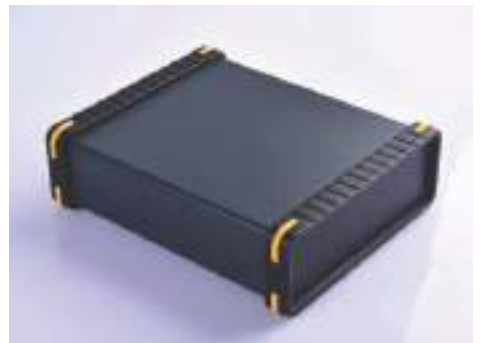

BAD 11013-C2 (W220)

185.5*60.5*220mm

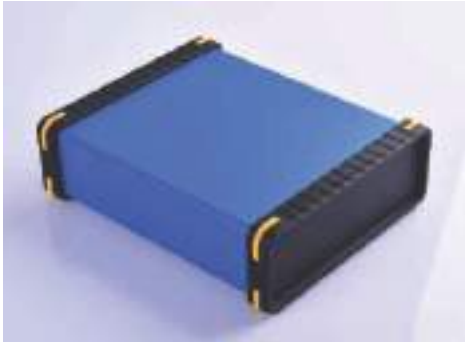

BAD 11013-C6(W220)
185.5*60.5*220mm



BAD 11013-C5(W220)
185.5*60.5*220mm



BAD 11018-C1 (W220)
100*100*220mm



BAD 11018-C2(W220)
100*100*220mm

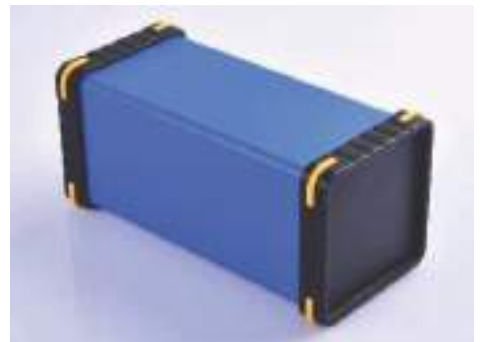

BAD 11018-C6(W220)
100*100*220mm

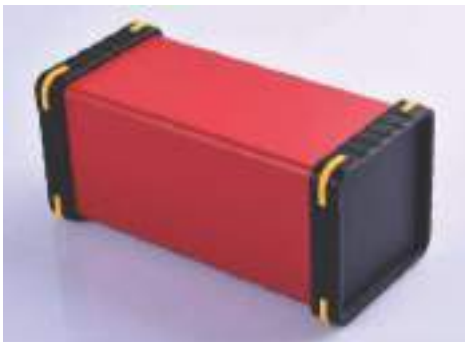

BAD 11018-C5(W220)
100*100*220mm

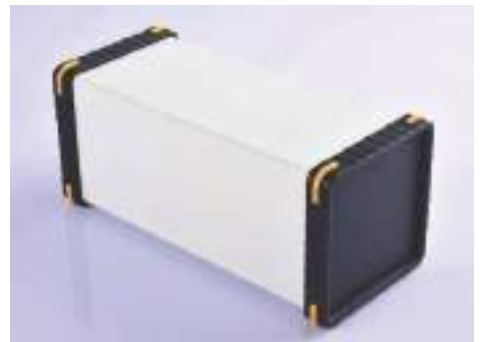

BAD 11020-C1 (W275)
120*120*275mm



BAD 11020-C2(W275)
120*120*275mm

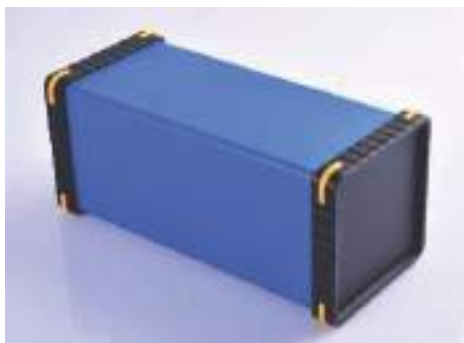

BAD 11020-C6(W275)
120*120*275mm

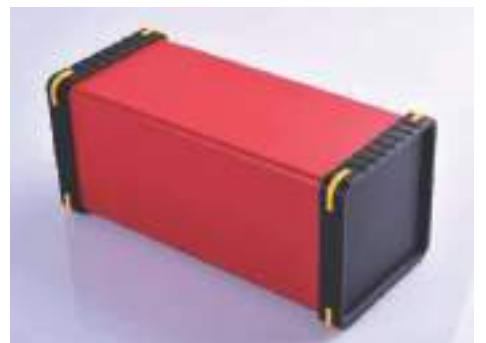

BAD 11020-C5(W275)
120*120*275mm



BAD 11020-C1 (W275)+BTS
120*120*275mm



BAD 11020-C2(W275)+BTS
120*120*275mm



BAD 11020-C6(W275)+BTS
120*120*275mm



BAD 11020-C5(W275)+BTS
120*120*275mm



BAD 11021-C1 (W275)
140*140*275mm



BAD 11021-C2(W275)
140*140*275mm



BAD 11021-C6(W275)
140*140*275mm



BAD 11021-C5(W275)
140*140*275mm



BAD 11021-C1 (W275)+BTS
140*140*275mm



BAD 11021-C2(W275)+BTS

140*140*275mm



BAD 11021-C6(W275)+BTS

140*140*275mm



BAD 11021-C5(W275)+BTS

140*140*275mm

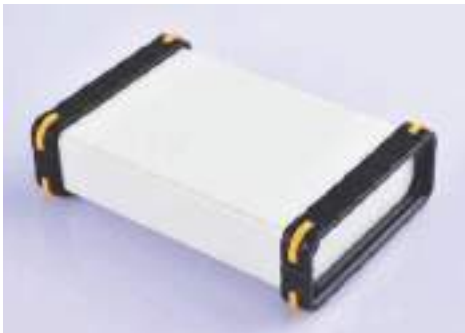

BAD 11002-T1 (W140)

96*33*140mm

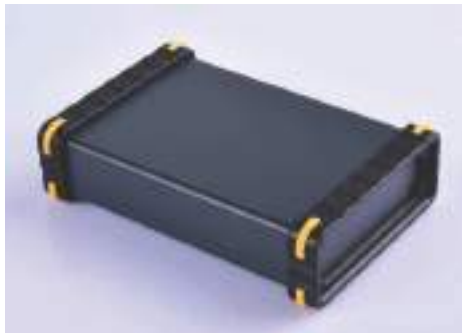

BAD 11002-T2(W140)

96*33*140mm



BAD 11011-T1 (W220)

165*51*220mm

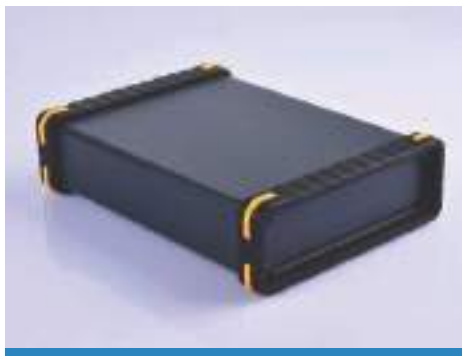

BAD 11011-T2(W220)

165*51*220mm



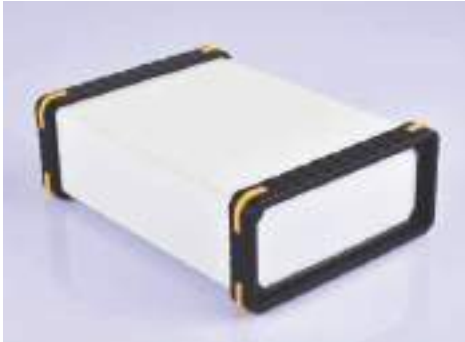

BAD 11012-T1 (W220)

165*70*220mm

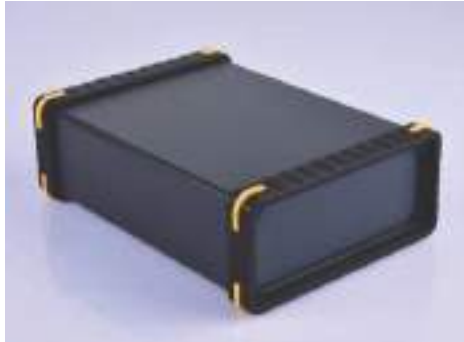

BAD 11012-T2(W220)

165*70*220mm



BAD 11013-T1 (W220)

185.5*60.5*220mm

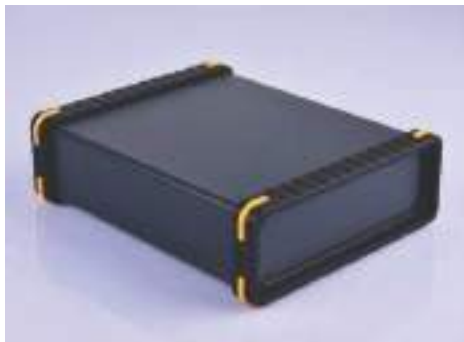

BAD 11013-T2(W220)

185.5*60.5*220mm



BAD 11017-T1 (W275)

200*100*275mm

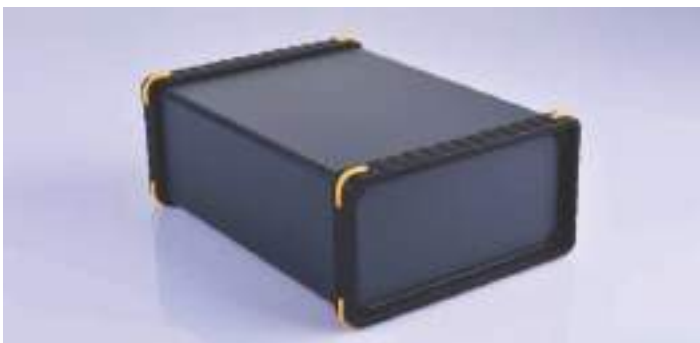

BAD 11017-T2(W275)

200*100*275mm

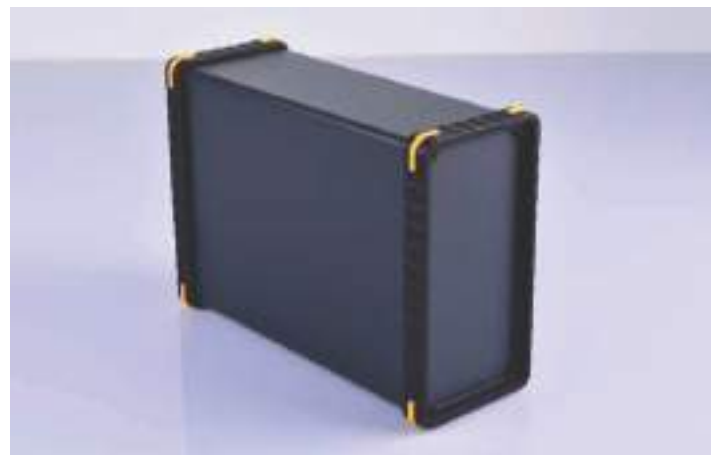



BAD 11017-T1 (W275)+BTS

200*100*275mm

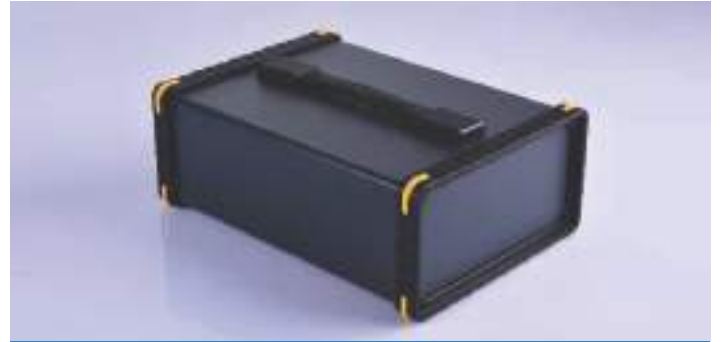

BAD 11017-T2(W275)+BTS

200*100*275mm



BAD 11018-T1 (W220)

100*100*220mm



BAD 11018-T2(W220)

100*100*220mm



BAD 11019-T1 (W220)

126*96*220mm

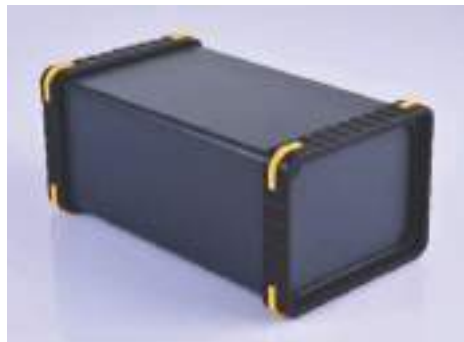

BAD 11019-T2(W220)

126*96*220mm



BAD 11020-T1 (W275)

120*120*275mm

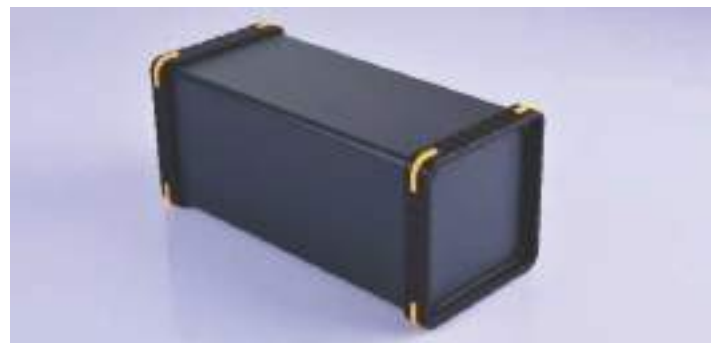

BAD 11020-T2(W275)

120*120*275mm

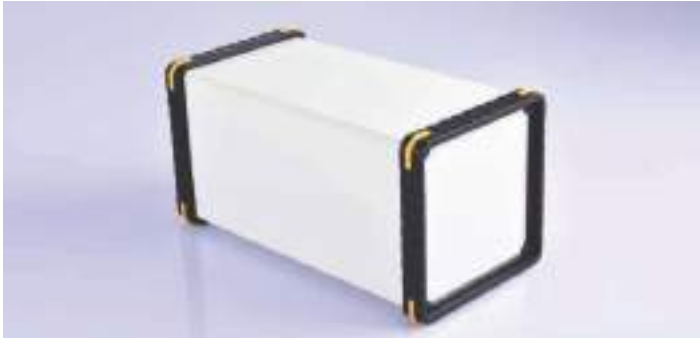

BAD 11021-T1 (W275)

140*140*275mm

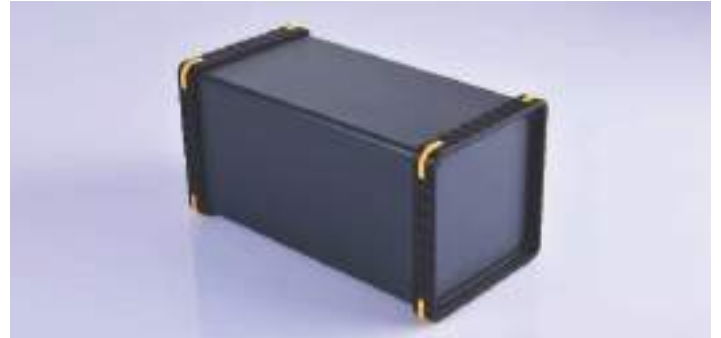

BAD 11021-T2(W275)

140*140*275mm



BAD 11021-T1 (W275)+BTS

140*140*275mm



BAD 11021-T2(W275)+BTS

140*140*275mm



BAD 11023-T1 (W275)+BTS

200*100*275mm



BAD 11023-T2(W275)+BTS

200*100*275mm



BAW 12009-B7(W160)

110*50*160mm

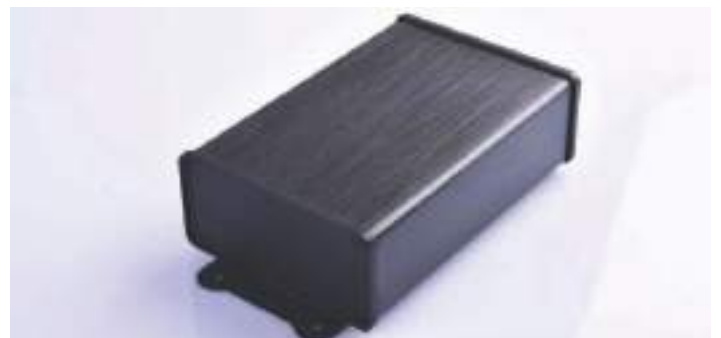



BWA 21001-A1
105*36*31mm



BWA 21003-A1
115*68*44mm



BWA 21003-B1
115*68*44mm



BWA 21004-A1
124*79*58mm



BWA 21006-A1
155*103*61mm



BWA 21006-B1
155*103*61mm



BWA 21007-A1
196*126*81mm



BWA 21007-B1
196*126*81mm



BWA 21008-A1
225*150*79mm



BWA 21008-B1
225*150*79mm

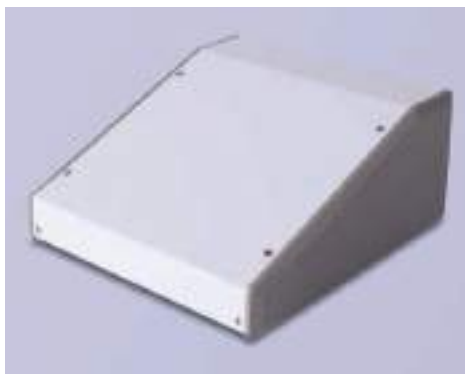
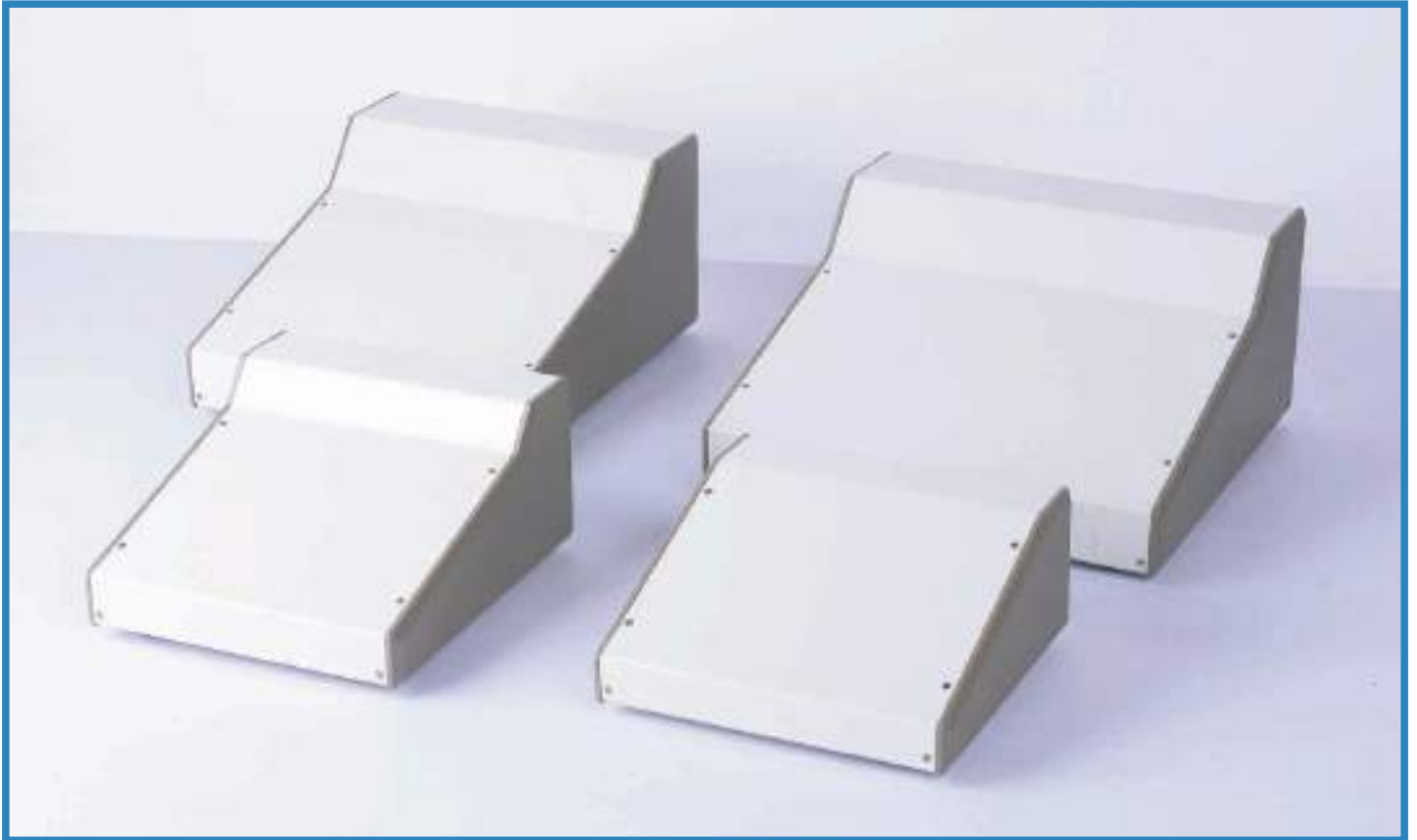

BDA 40001-A1(W165)

200*90*165mm



BDA 40001-A1(W200)

200*90*200mm

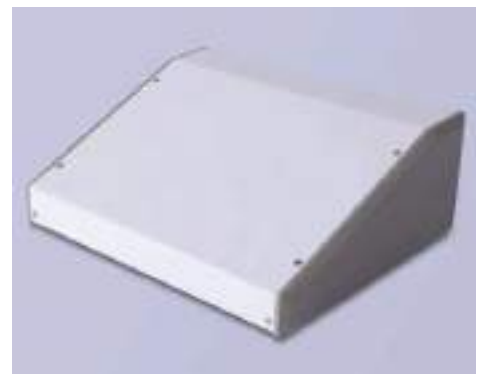

BDA 40001-A1(W230)

200*90*230mm

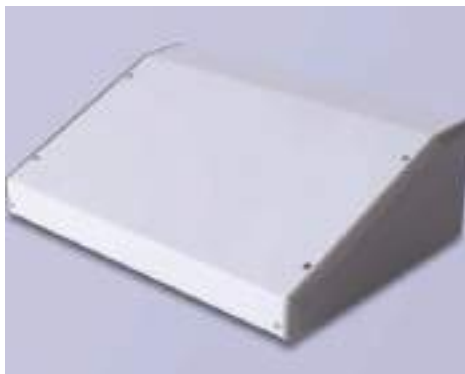

BDA 40001-A1(W250)

200*90*250mm



BDA 40002-A1(W200)

230*110*200mm

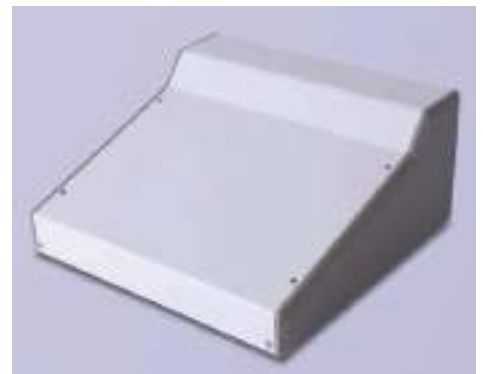

BDA 40002-A1(W250)

230*110*250mm

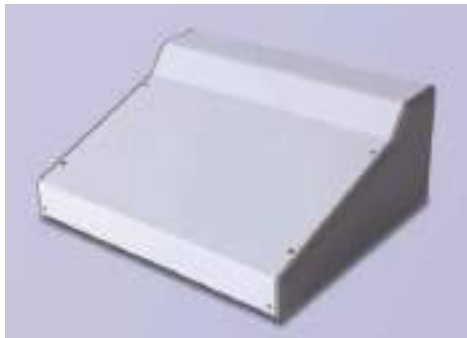

BDA 40002-A1(W290)

230*110*290mm

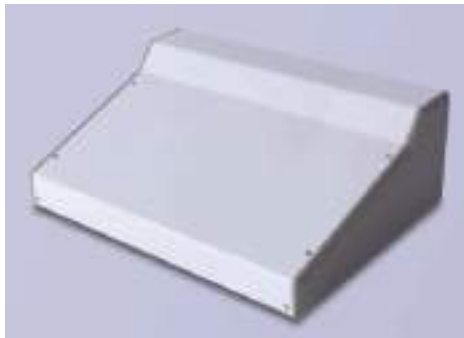

BDA 40002-A1(W350)

230*110*350mm

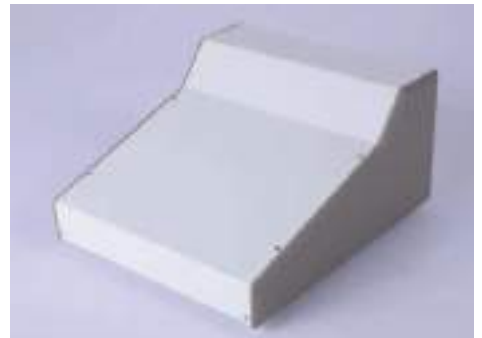

BDA 40003-A1(W250)

300*150*250mm

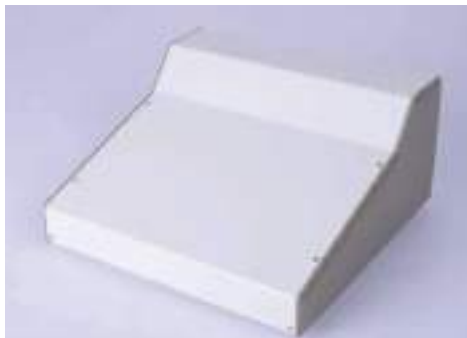

BDA 40003-A1(W300)

300*150*300mm

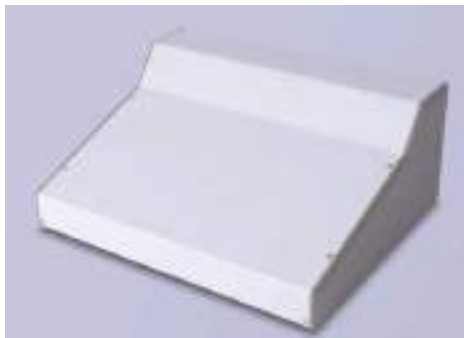

BDA 40003-A1(W350)

300*150*350mm

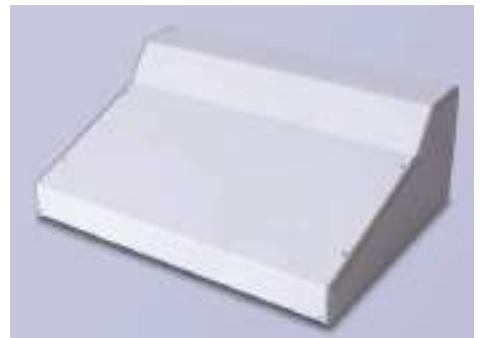

BDA 40003-A1(W450)

300*150*450mm





BDA 40004-A1(W100)

150*70*100mm



BDA 40004-A2(W100)

150*70*100mm



BDA 40004-A5(W100)

150*70*100mm



BDA 40004-A6(W100)

150*70*100mm



BDA 40004-A1(W140)

150*70*140mm



BDA 40004-A2(W140)

150*70*140mm



BDA 40004-A5(W140)

150*70*140mm



BDA 40004-A6(W140)

150*70*140mm



BDA 40004-A1(W170)

150*70*170mm



BDA 40004-A2(W170)

150*70*170mm



BDA 40004-A5(W170)

150*70*170mm



BDA 40004-A6(W170)

150*70*170mm



BDA 40004-A1(W200)

150*70*200mm



BDA 40004-A2(W200)

150*70*200mm



BDA 40004-A5(W200)

150*70*200mm



BDA 40004-A6(W200)

150*70*200mm



BDA 40005-A1(W195)

150*110*195mm



BDA 40005-A2(W195)

150*110*195mm



BDA 40005-A5(W195)

150*110*195mm



BDA 40005-A6(W195)

150*110*195mm



BDA 40005-A1(W275)

150*110*275mm



BDA 40005-A2(W275)

150*110*275mm



BDA 40005-A5(W275)

150*110*275mm



BDA 40005-A6(W275)

150*110*275mm



BDA 40005-A1(W275)+BTS
150*110*275mm



BDA 40005-A2(W275)+BTS
150*110*275mm



BDA 40005-A5(W275)+BTS
150*110*275mm



BDA 40005-A6(W275)+BTS
150*110*275mm



BDA 40006-A1(W195)
150*160*195mm



BDA 40006-A2(W195)
150*160*195mm



BDA 40006-A5(W195)
150*160*195mm



BDA 40006-A6(W195)
150*160*195mm



BDA 40006-A1(W275)
150*160*275mm



BDA 40006-A2(W275)
150*160*275mm



BDA 40006-A5(W275)
150*160*275mm



BDA 40006-A6(W275)
150*160*275mm



BDA 40006-A1(W275)+BTS
150*160*275mm



BDA 40006-A2(W275)+BTS
150*160*275mm



BDA 40006-A5(W275)+BTS
150*160*275mm



BDA 40006-A6(W275)+BTS
150*160*275mm



BDA 40006-A1(W325)
150*160*325mm



BDA 40006-A2(W325)
150*160*325mm



BDA 40006-A5(W325)
150*160*325mm



BDA 40006-A6(W325)
150*160*325mm



BDA 40006-A1(W325)+BTS
150*160*325mm



BDA 40006-A2(W325)+BTS
150*160*325mm



BDA 40006-A5(W325)+BTS
150*160*325mm



BDA 40006-A6(W325)+BTS
150*160*325mm



BDA 40007-A1(W195)

220*80*195mm



BDA 40007-A2(W195)

220*80*195mm



BDA 40007-A5(W195)

220*80*195mm



BDA 40007-A6(W195)

220*80*195mm



BDA 40007-A1(W275)

220*80*275mm



BDA 40007-A2(W275)

220*80*275mm



BDA 40007-A5(W275)

220*80*275mm



BDA 40007-A6(W275)

220*80*275mm



BDA 40008-A1(W195)

220*120*195mm



BDA 40008-A2(W195)

220*120*195mm



BDA 40008-A5(W195)

220*120*195mm



BDA 40008-A6(W195)

220*120*195mm



BDA 40008-A1(W275)

220*120*275mm



BDA 40008-A2(W275)

220*120*275mm



BDA 40008-A5(W275)

220*120*275mm

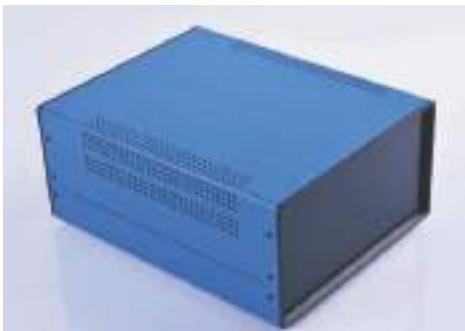

BDA 40008-A6(W275)

220*120*275mm



BDA 40008-A1(W275)+BTS

220*120*275mm



BDA 40008-A2(W275)+BTS

220*120*275mm



BDA 40008-A5(W275)+BTS

220*120*275mm



BDA 40008-A6(W275)+BTS

220*120*275mm



BDA 40008-A1(W325)

220*120*325mm



BDA 40008-A2(W325)

220*120*325mm



BDA 40008-A5(W325)

220*120*325mm



BDA 40008-A6(W325)

220*120*325mm



BDA 40008-A1(W325)+BTS

220*120*325mm



BDA 40008-A2(W325)+BTS

220*120*325mm



BDA 40008-A5(W325)+BTS

220*120*325mm



BDA 40008-A6(W325)+BTS

220*120*325mm



BDA 40009-A1(W115)

280*80*115mm



BDA 40009-A2(W115)

280*80*115mm



BDA 40009-A5(W115)

280*80*115mm



BDA 40009-A6(W115)

280*80*115mm



BDA 40009-A1(W170)

280*80*170mm



BDA 40009-A2(W170)

280*80*170mm



BDA 40009-A5(W170)

280*80*170mm



BDA 40009-A6(W170)

280*80*170mm



BDA 40009-A1(W210)

280*80*210mm



BDA 40009-A2(W210)

280*80*210mm



BDA 40009-A5(W210)

280*80*210mm



BDA 40009-A6(W210)

280*80*210mm



BDA 40009-A1(W250)

280*80*250mm



BDA 40009-A2(W250)

280*80*250mm



BDA 40009-A5(W250)

280*80*250mm



BDA 40009-A6(W250)

280*80*250mm



BDA 40009-A1(W325)

280*80*325mm



BDA 40009-A2(W325)

280*80*325mm



BDA 40009-A5(W325)

280*80*325mm



BDA 40009-A6(W325)

280*80*325mm



- Plastic
- Iron
- Aluminium

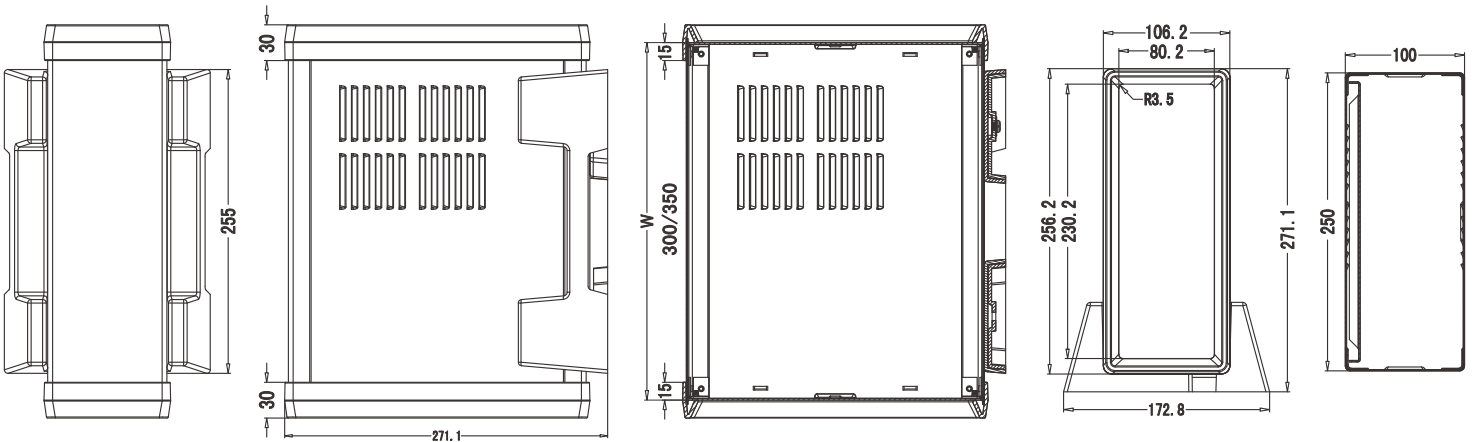

A1



A2



A3



A4



BTS

Code No:		Part No:		Weight	
BDA 40017 (100*250)		BDA 40017 -W300	BDA 40017 -W300	3.8 KG	A1
				+BTS 4.0KG	A2
		BDA 40017-W350	BDA 40017 -W350	4.3 KG	A3
				+BTS 4KG	A4
					BTS

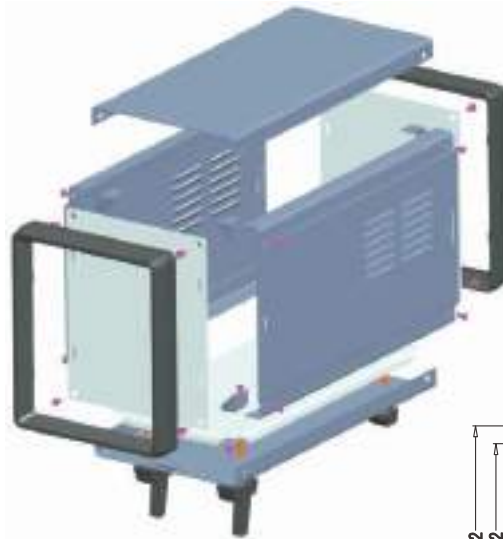

- Plastic
- Iron
- Aluminium

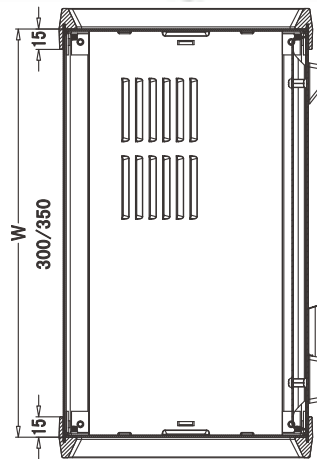
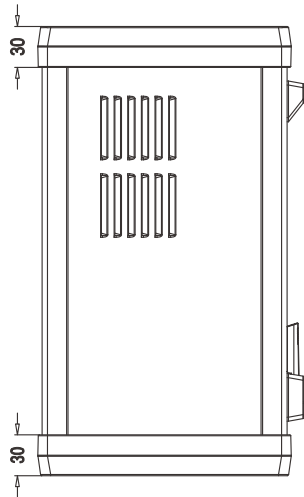
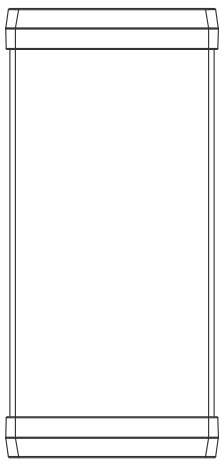
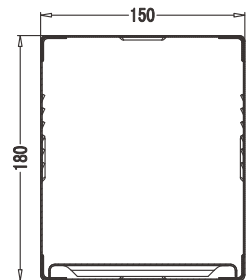
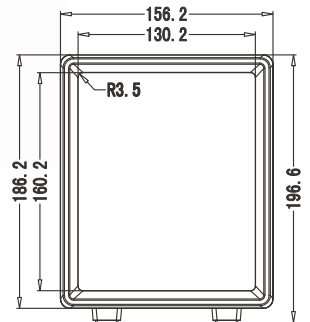

A1



A2



A3



A4



BTS

Code No:	Part No:			Weight	
	1	2+ - BTS	3		
BDA 40018 (150*180) 	BDA 40018-W300	40020	2-003	3-003	A1
					A2
					A3
					A4
	BDA 40018-W350	40020	2-004	3-013	BTS

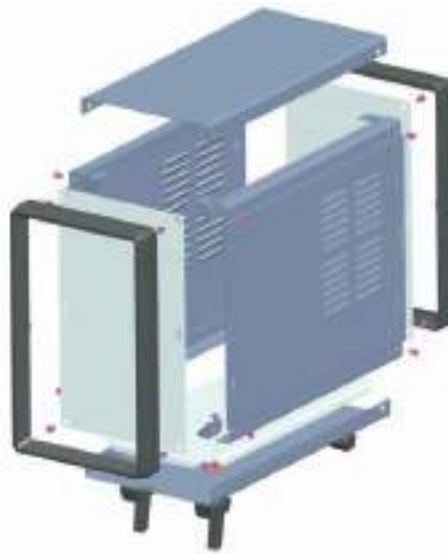

- Plastic
- Iron
- Aluminium

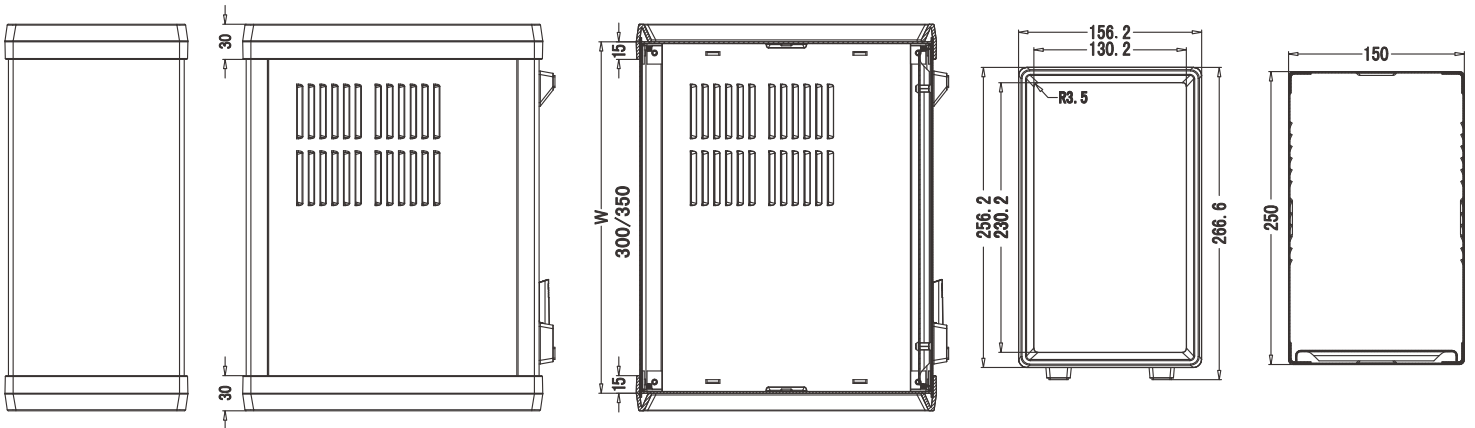

A1



A2



A3



A4



BTS

Code No:	Part No:			Weight	
	1	2+ - BTS	3		
BDA 40019 (150*250) 	BDA 40019-W300	40023	2-003	3-001	A1
					A2
					A3
	BDA 40019-W350	40023	2-004	3-002	A4
					BTS
					3.5 KG
					+BTS 3.7 KG
					3.95 KG
					+BTS 4.15 KG

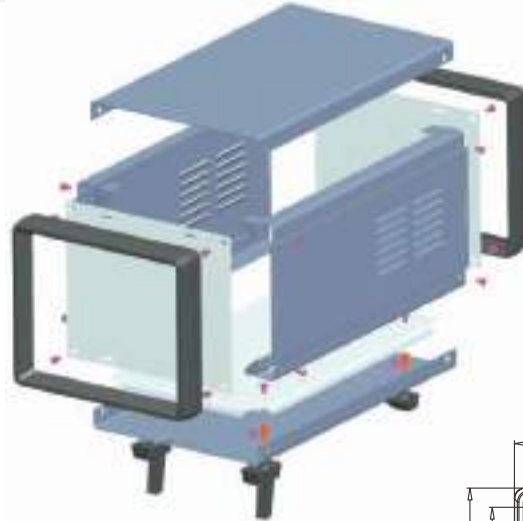

- Plastic
- Iron
- Aluminium

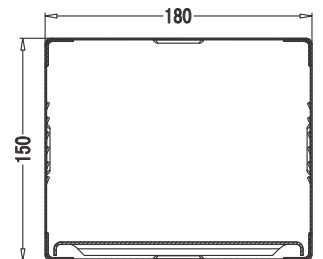
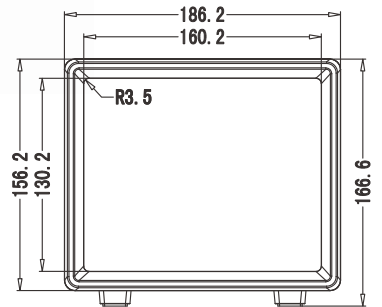
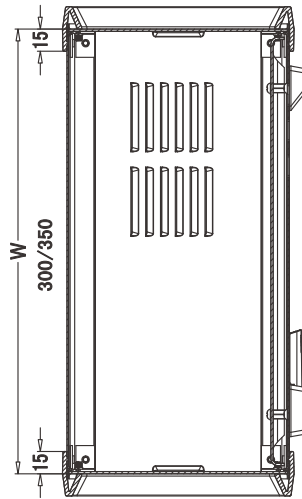
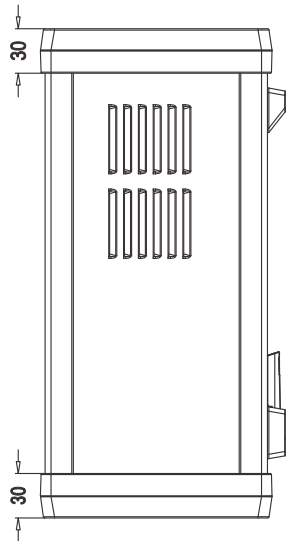
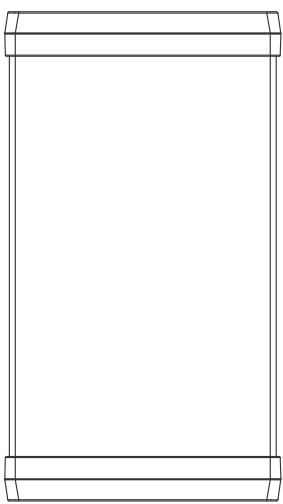

A1



A2



A3



A4



BTS

Code No:	Part No:			Weight	
	1	2+ - BTS	3		
BDA 40020 (180*150)	BDA 40020 (300)	40020	2-005	3-004	A1
					A2
					A3
					A4
	BDA 40020 (350)	40020	2-006	3-005	BTS
					+BTS 3.65 KG
					3 KG
					+BTS 3.2 KG
					3.45 KG

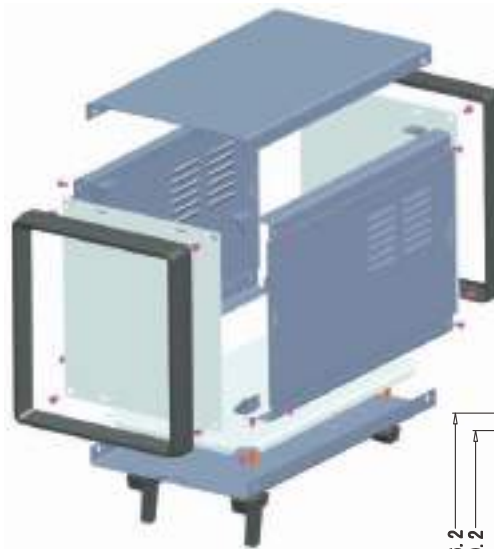
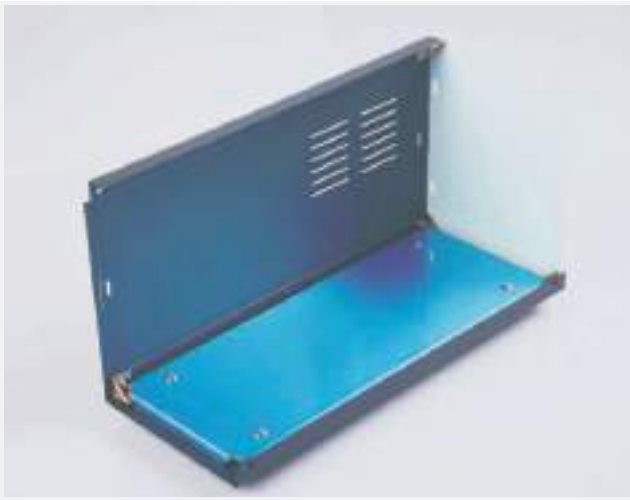

- Plastic
- Iron
- Aluminium

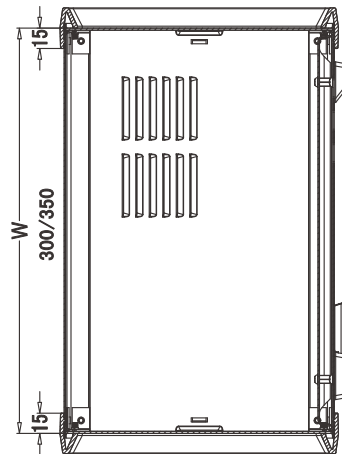
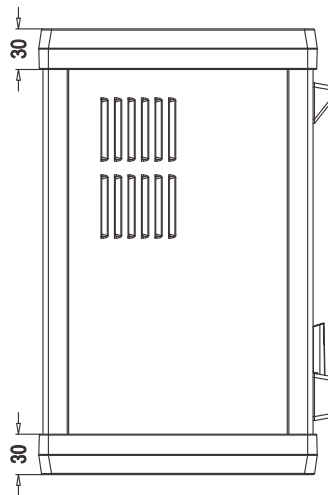
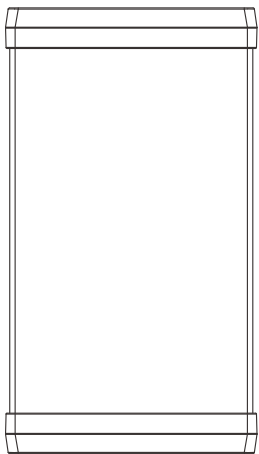
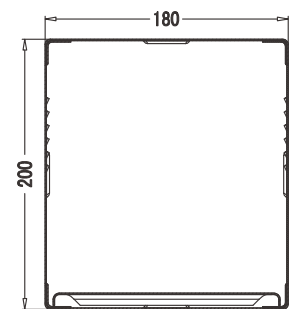
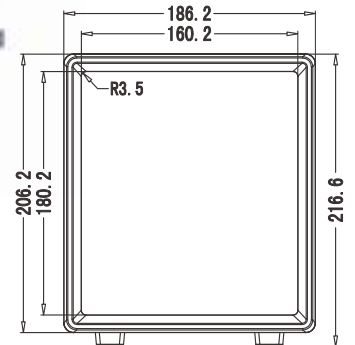

A1



A2



A3



A4



BTS

Code No:	Part No:			Weight		
	1	2+ - BTS	3			
BDA 40021 (180*200) 	BDA 40021 (300)	40021	2-005	3-006	3.4 KG	A1
					+BTS 3.6 KG	A2
	BDA 40021 (350)	40021	2-006	3-007	3.85 KG	A3
					+BTS 4.05 KG	A4
						BTS

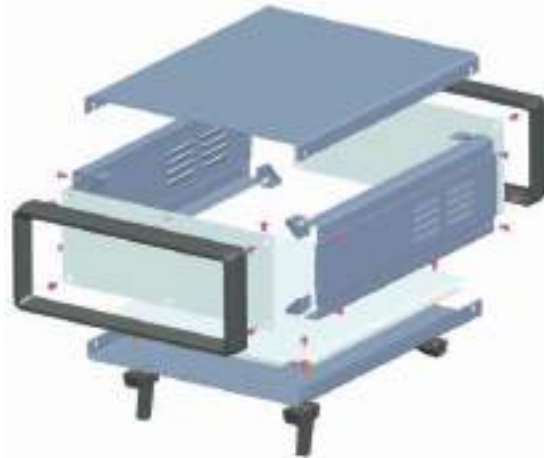

Plastic
 Iron
 Aluminium

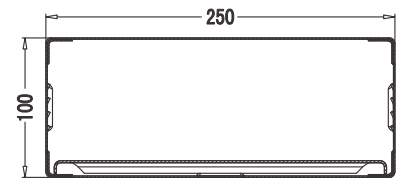
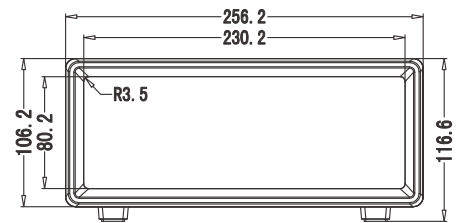
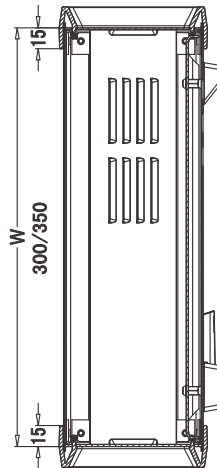
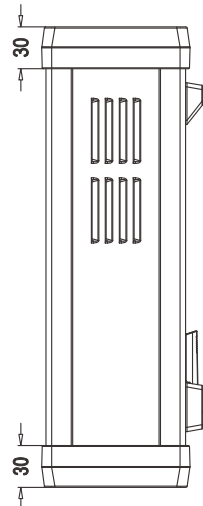
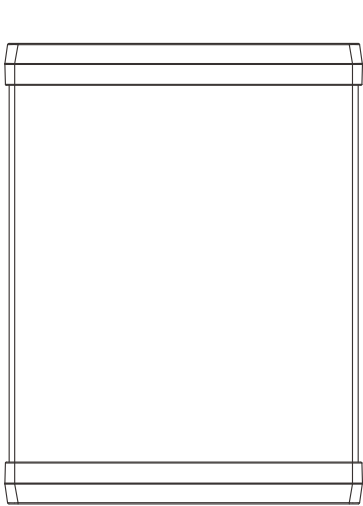

A1



A2



A3



A4



BTS

Code No:	Part No:	Weight			
		1	2+ - BTS	3	
BDA 40022 (250*100) 	BDA 40022 (300)	40022	2-007	3-008	A1
					A2
					A3
					A4
	BDA 40022 (350)	40022	2-008	3-009	BTS

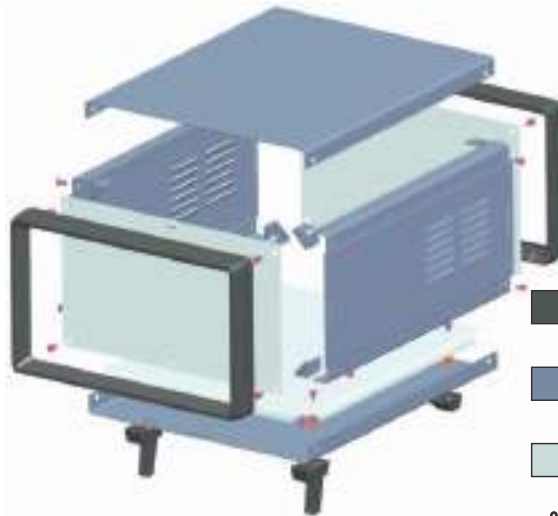

- Plastic
- Iron
- Aluminium

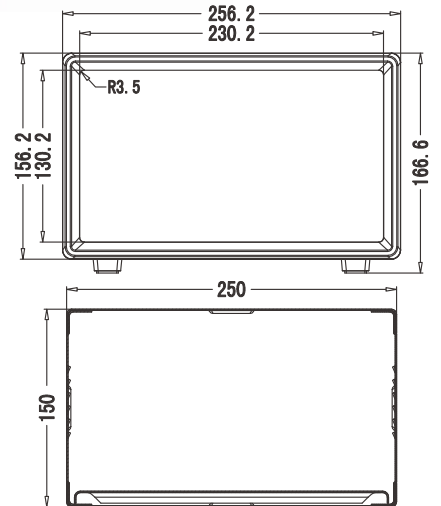
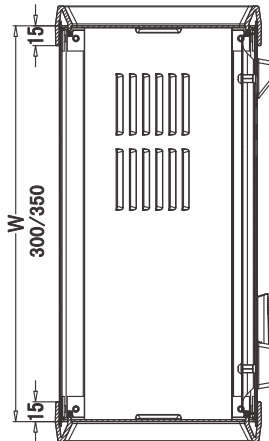
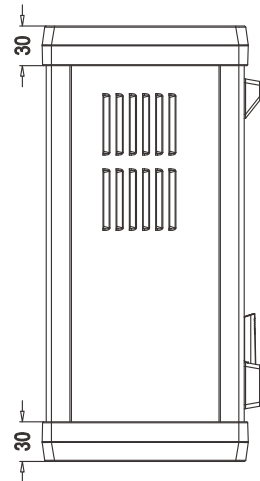
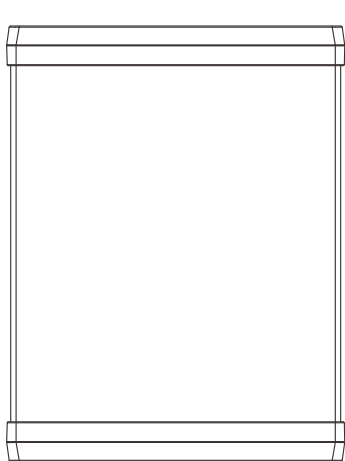

A1



A2



A3



A4



BTS

Code No:	Part No:			Weight		
	1	2+ - BTS	3			
BDA 40023 (250*150)	BDA 40023 (300)	40023	2-007	3-004	3.55 KG	A1
					+BTS 3.75 KG	A2
	BDA 40023 (350)	40023	2-008	3-005	4.05 KG	A3
					+BTS 4.25 KG	A4
						BTS

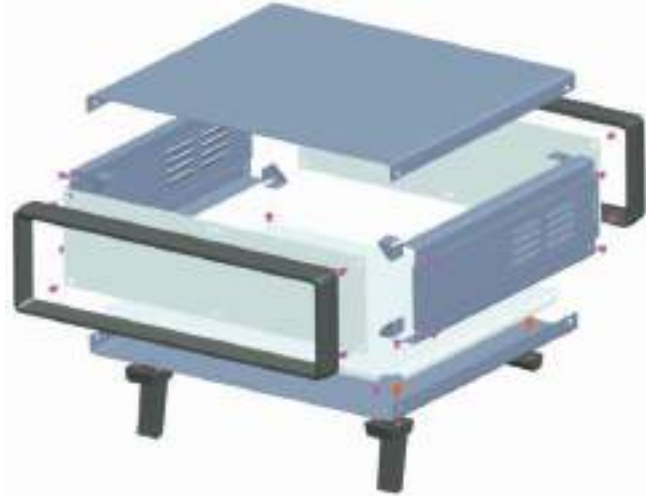

Plastic
 Iron
 Aluminium

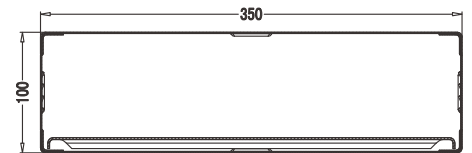
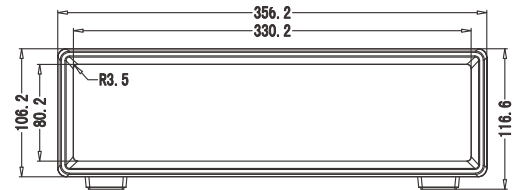
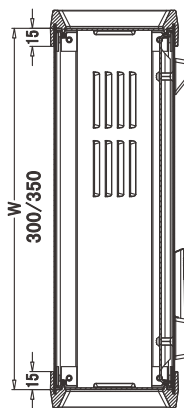
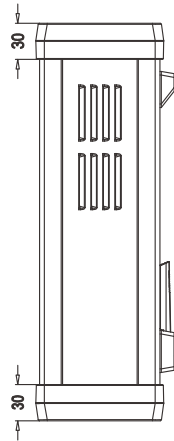
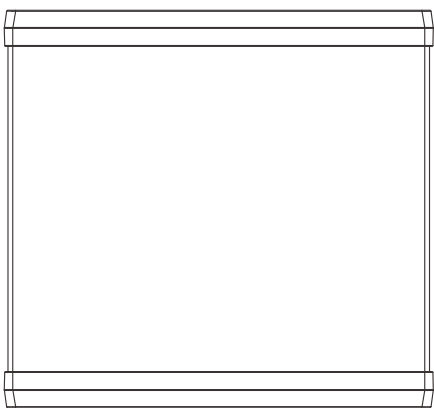

A1



A2



A3



A4



BTS

Code No:	Part No:			Weight		
	1	2	3			
BDA 40024 (350*100) 	BDA 40024-W300	40024	2-009	3-008	3.95 KG	A1
	BDA 40024-W350	40024	2-010	3-009	4.5 KG	A2

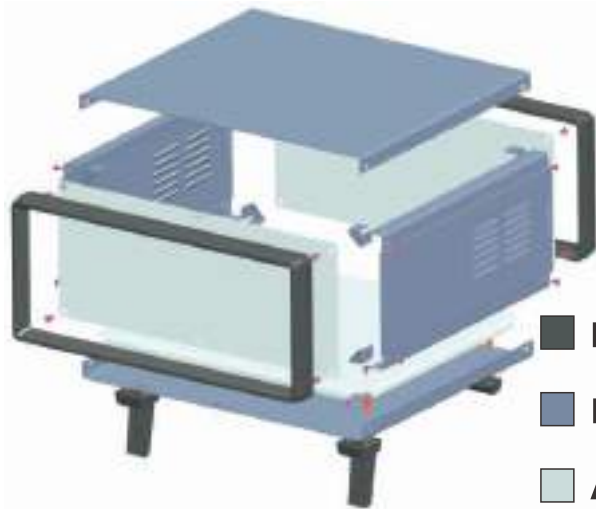

- Plastic
- Iron
- Aluminium

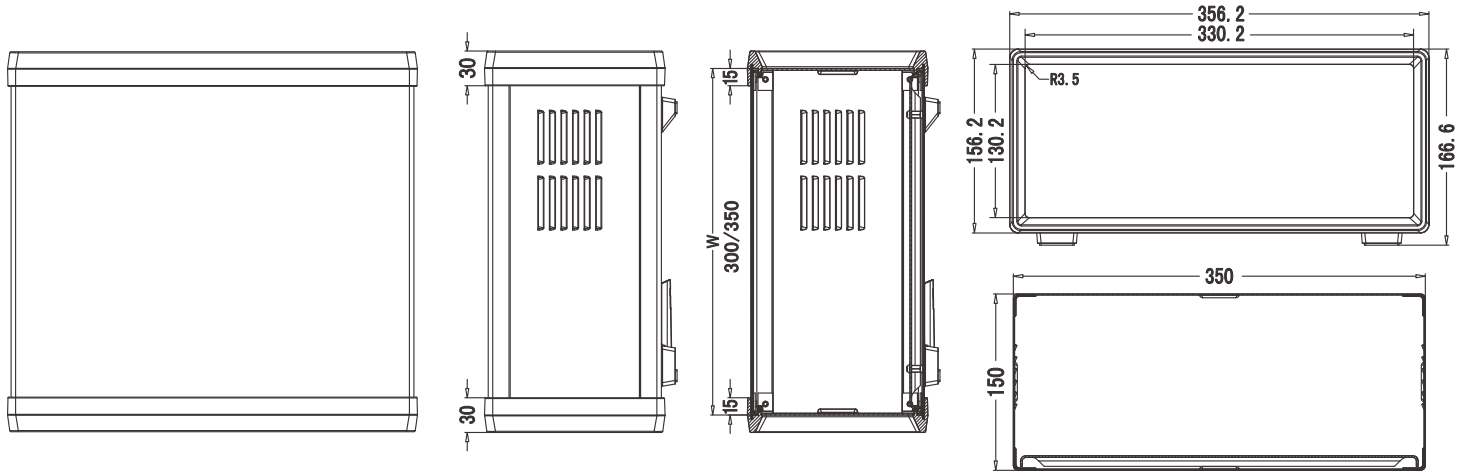

A1



A2



A3



A4



BTS

Code No:	Part No:			Weight		
	1	2	3			
BDA 40025 (350*150) 	BDA 40025-W300	40025	2-009	3-004	4.45 KG	A1
	BDA 40025-W350	40025	2-010	3-005	5.05 KG	A2

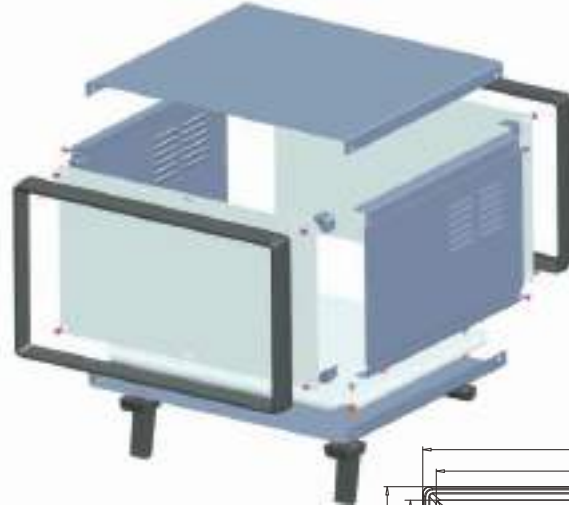

Plastic
 Iron
 Aluminium

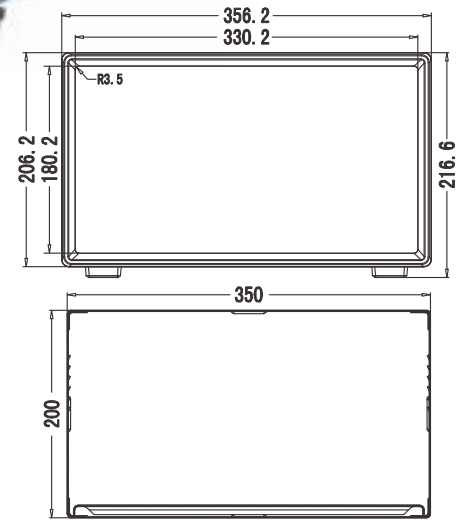
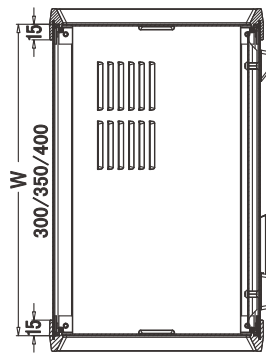
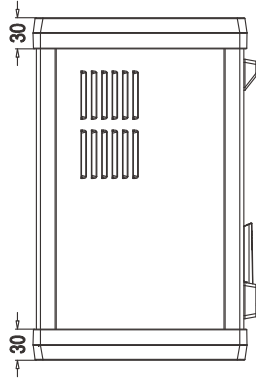
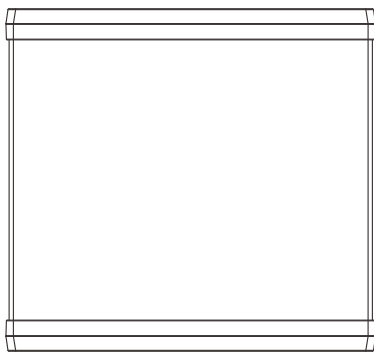

A1



A2



A3



A4



BTS

Code No:	Part No:			Weight		
	1	2	3			
BDA 40026 (350*200) 	BDA 40026-W300	40026	2-009	3-006	4.95 KG	A1
	BDA 40026-W350	40026	2-010	3-007	5.55 KG	A1
	BDA 40026-W400	40026	2-011	3-010	6.15 KG	A2



Plastic
 Iron
 Aluminium

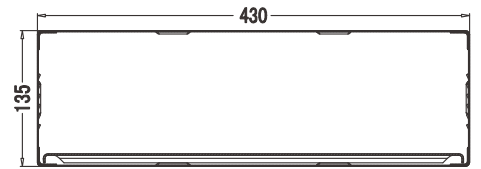
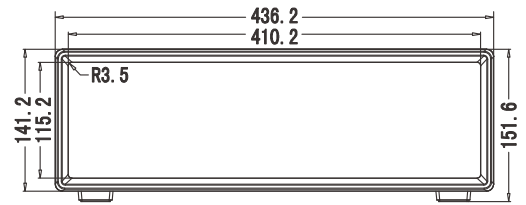
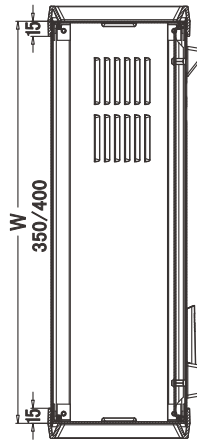
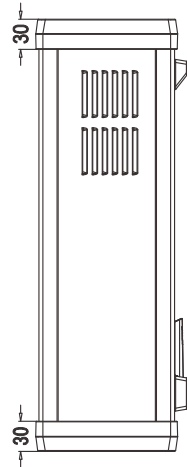
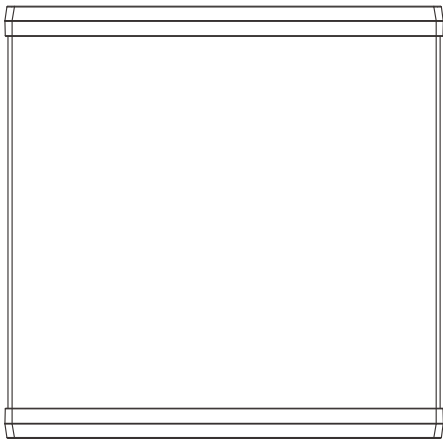

A1



A2



A3



A4



BTS

Code No:	Part No:			Weight		
	1	2	3			
BDA 40027 (430*135) 	BDA 40027-W350	40027	2-012	3-011	5.7 KG	A1
	BDA 40027-W400	40027	2-013	3-012	6.4 KG	A2

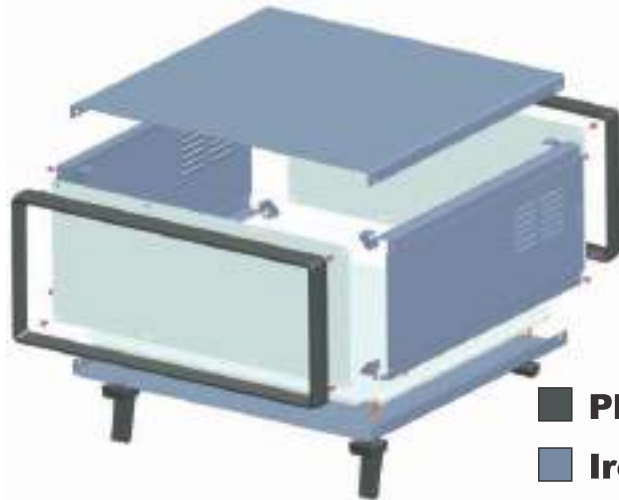

- Plastic
- Iron
- Aluminium

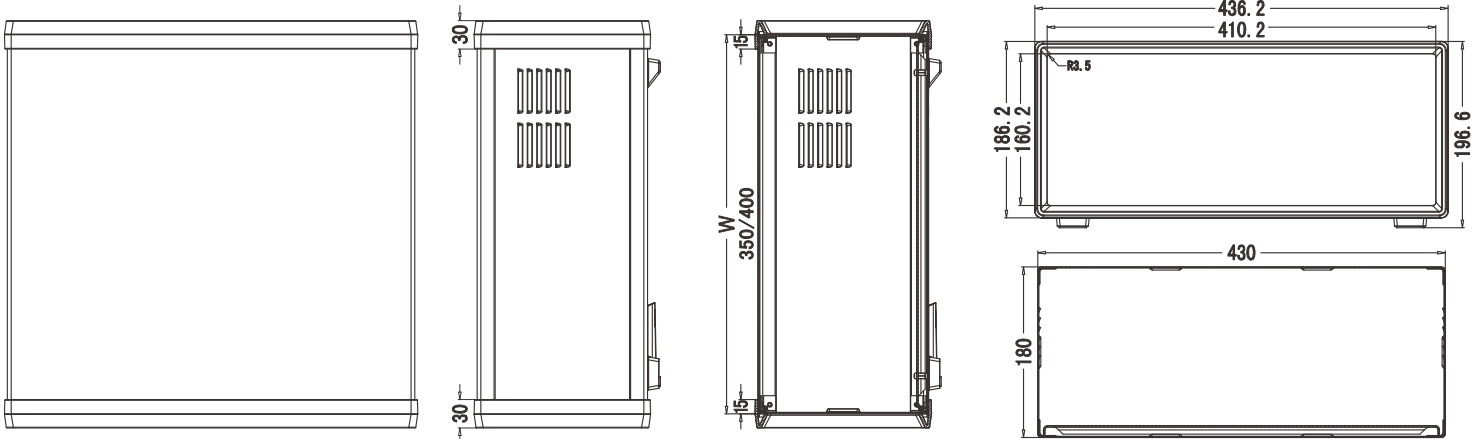

A1



A2



A3



A4



BTS

Code No:	Part No:			Weight		
	1	2	3			
BDA 40028 (430*180) 	BDA 40028-W350	40028	2-012	3-013	6.25 KG	A1
	BDA 40028-W400	40028	2-013	3-014	6.9 KG	A2

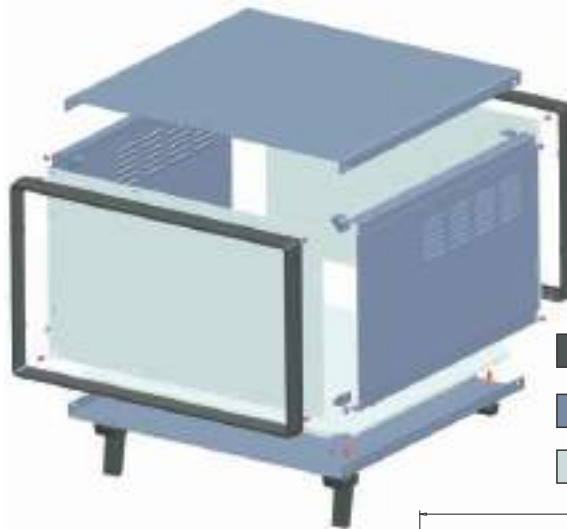

- Plastic
- Iron
- Aluminium

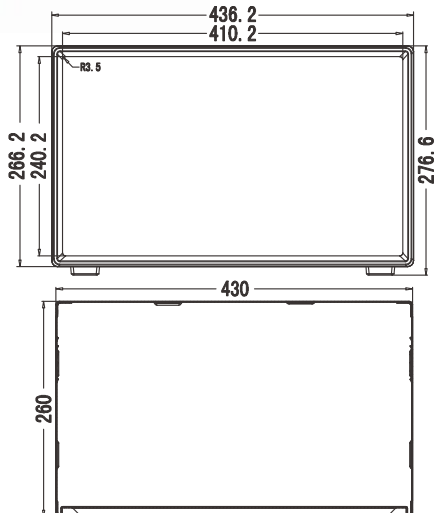
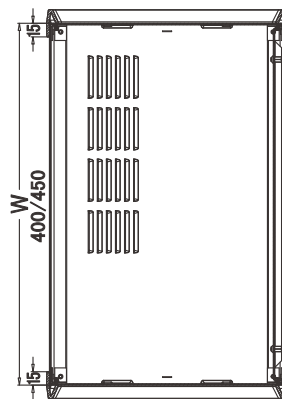
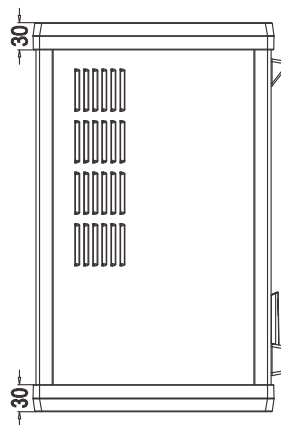
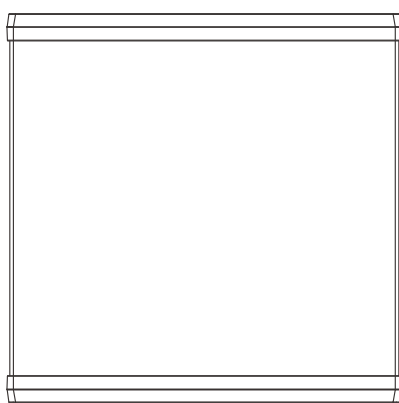

A1



A2



A3



A4



BTS

Code No:	Part No:			Weight		
	1	2	3			
BDA 40029 (430*260) 	BDA 40029-W400	40029	2-013	3-015	7.9 KG	A1
	BDA 40029-W450	40029	2-014	3-016	8.7 KG	A2

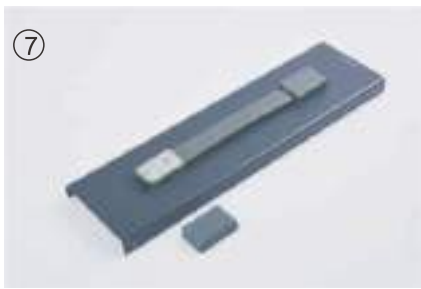
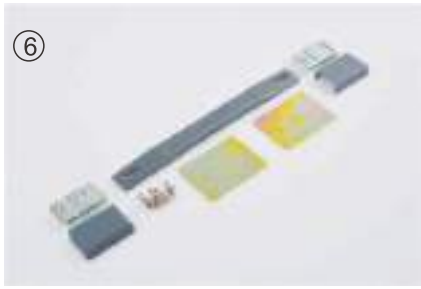

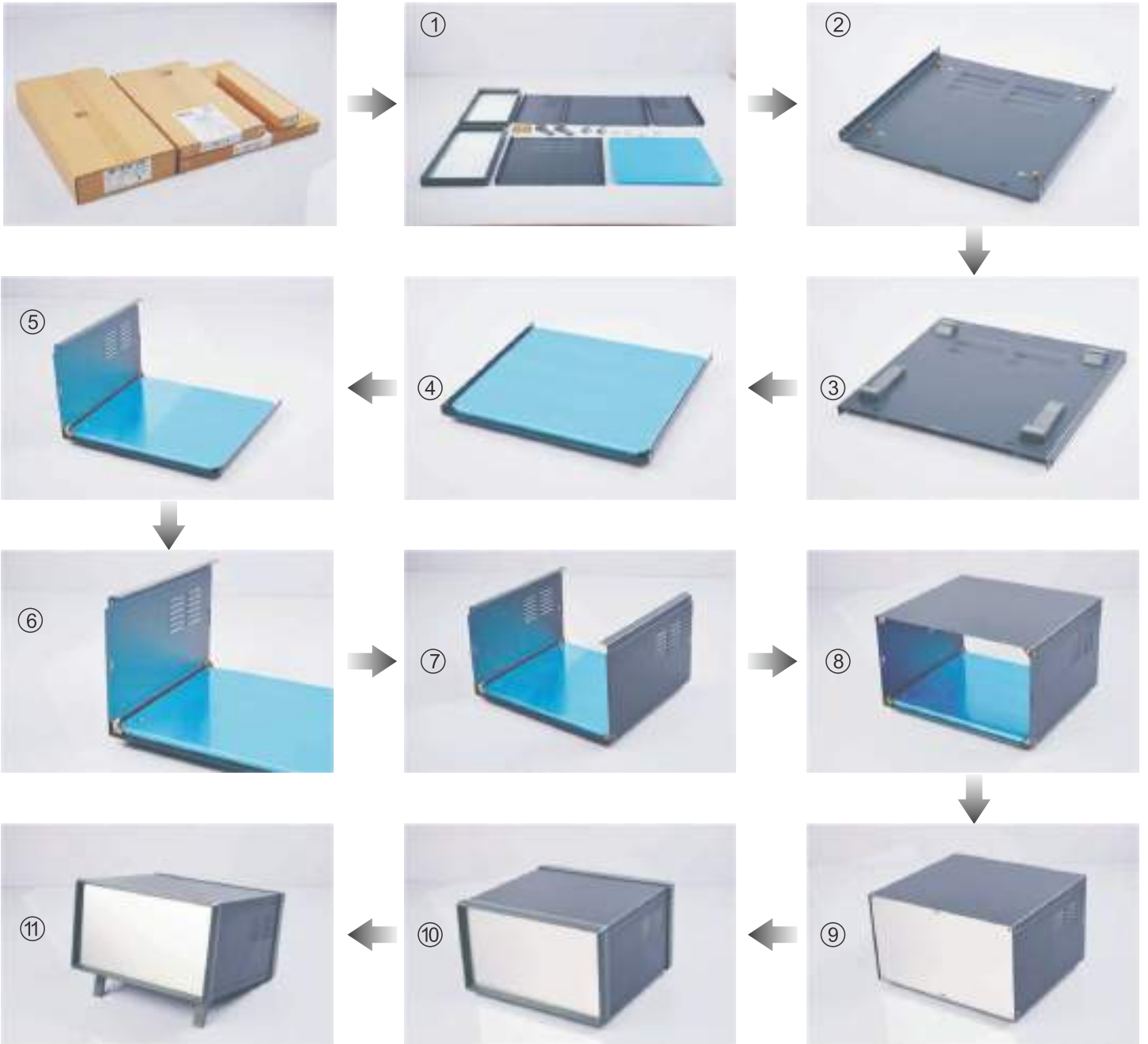



BDA 40080-A5
120*170*106mm



BDA 40081-A5
160*200*126mm



BDA 40082-A5
200*255*161mm



BDA 40051-A7
80*120*48mm



BDA 40051-A5
80*120*48mm



BDA 40051-A6
80*120*48mm



BDA 40052-A7
90*140*60mm



BDA 40052-A5
90*140*60mm



BDA 40052-A6
90*140*60mm



BDA 40053-A7
100*160*80mm



BDA 40053-A5
100*160*80mm



BDA 40053-A6
100*160*80mm



BDA 40080-A9

120*170*106mm



BDA 40081-A9

160*200*126mm



BDA 40082-A9

200*255*161mm



BDA 40080-A2

120*170*106mm



BDA 40081-A2

160*200*126mm



BDA 40082-A2

200*255*161mm



BDA 40054-A7
120*180*100mm



BDA 40054-A5
120*180*100mm



BDA 40054-A6
120*180*100mm



BDA 40055-A7
140*230*110mm

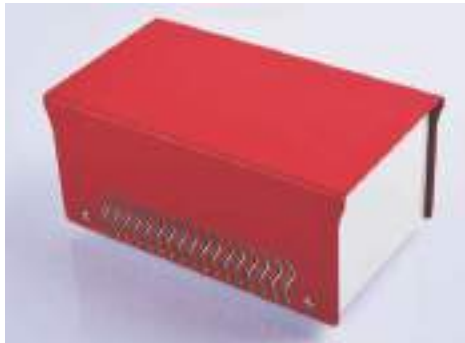

BDA 40055-A5
140*230*110mm



BDA 40055-A6
140*230*110mm



BDA 40056-A7
160*280*120mm

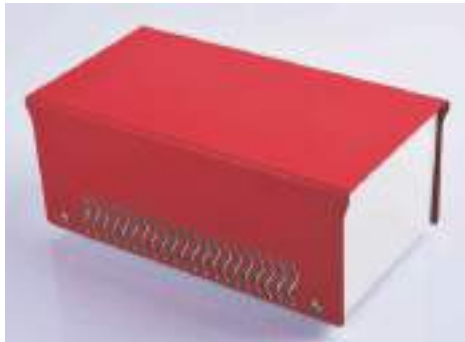

BDA 40056-A5
160*280*120mm



BDA 40056-A6
160*280*120mm



BDA 40057-A7
150*170*45mm



BDA 40057-A5
150*170*45mm



BDA 40057-A6
150*170*45mm



BDA 40058-A7
150*170*70mm



BDA 40058-A5
150*170*70mm



BDA 40058-A6
150*170*70mm



BDA 40059-A7
200*200*50mm



BDA 40059-A5
200*200*50mm



BDA 40059-A6
200*200*50mm



BDA 40060-A7
200*200*80mm



BDA 40060-A5
200*200*80mm



BDA 40060-A6
200*200*80mm



BDA 40061-A7
200*260*50mm



BDA 40061-A5
200*260*50mm



BDA 40061-A6
200*260*50mm



BDA 40062-A7
200*260*80mm



BDA 40062-A5
200*260*80mm



BDA 40062-A6
200*260*80mm



BDA 40063-A7
240*240*50mm



BDA 40063-A5
240*240*50mm



BDA 40063-A6
240*240*50mm



BDA 40064-A7
240*240*80mm



BDA 40064-A5
240*240*80mm



BDA 40064-A6
240*240*80mm



BDA 40065-A7
280*260*50mm



BDA 40065-A5
280*260*50mm



BDA 40065-A6
280*260*50mm



BDA 40066-A7
280*260*80mm



BDA 40066-A5
280*260*80mm



BDA 40066-A6
280*260*80mm

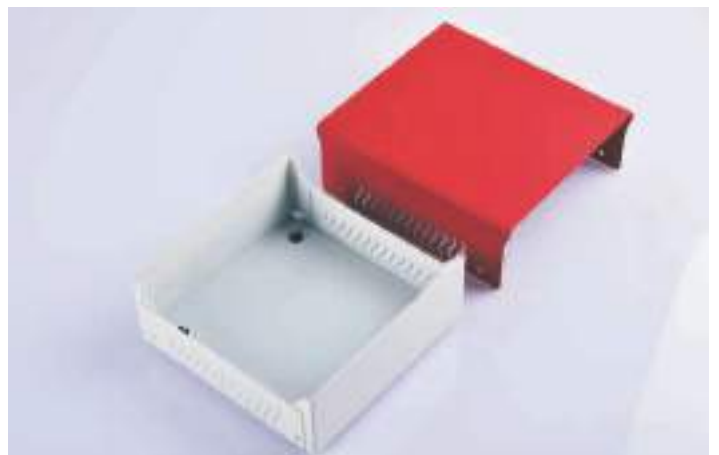
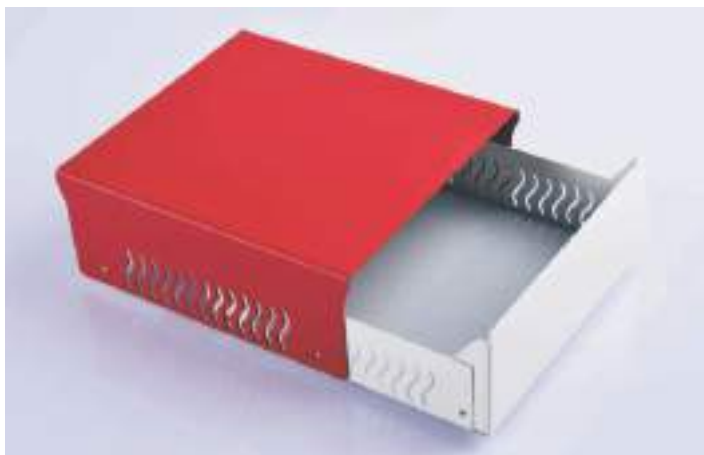

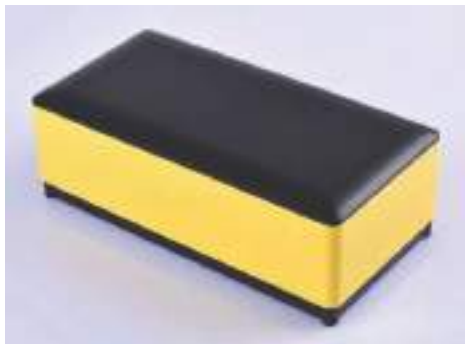

BAD 11017-D10-B2(W50)

200*100*50mm

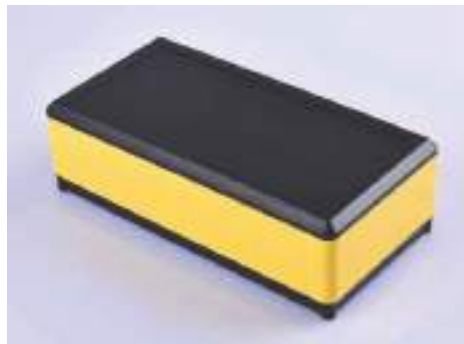

BAD 11017-D10-A2(W40)

200*100*40mm

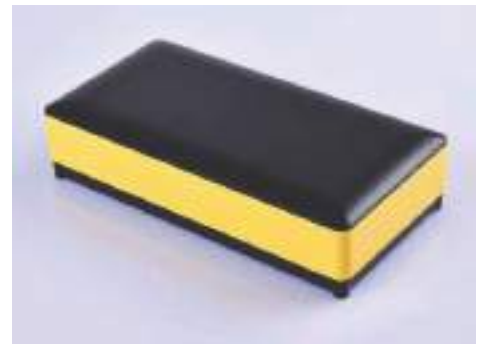

BAD 11017-D10-B2(W30)

200*100*30mm



BAD 11017-D10-A2(W25)

200*100*25mm



BAD 11017-D10-B2(W20)

200*100*20mm

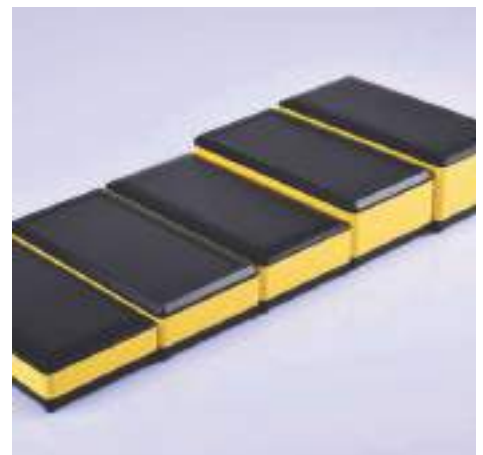



BAD 11018-D10-B2(W50)

100*100*50mm

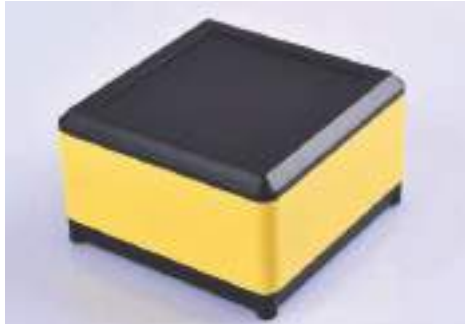

BAD 11018-D10-A2(W40)

100*100*40mm

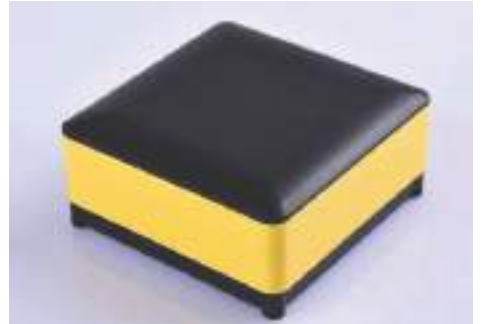

BAD 11018-D10-B2(W30)

100*100*30mm

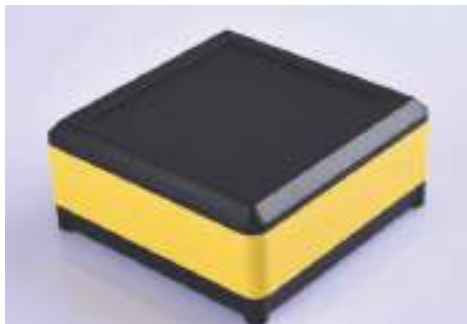

BAD 11018-D10-A2(W25)

100*100*25mm

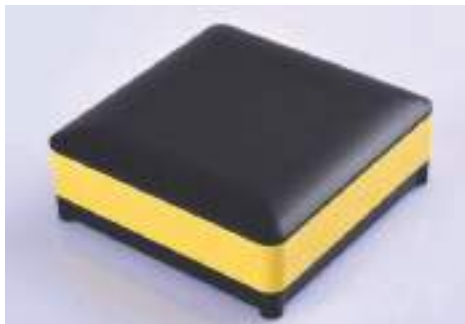

BAD 11018-D10-B2(W20)

100*100*20mm

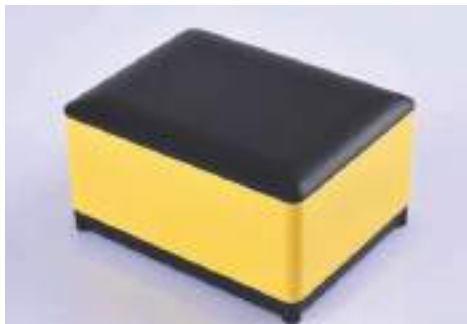

BAD 11019-D10-B2(W50)

126*96*50mm

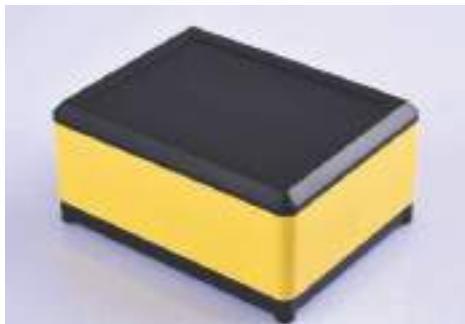

BAD 11019-D10-A2(W40)

126*96*40mm

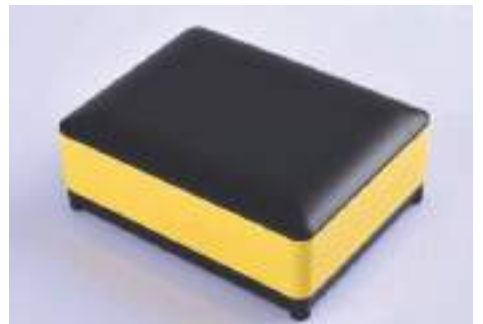

BAD 11019-D10-B2(W30)

126*96*30mm

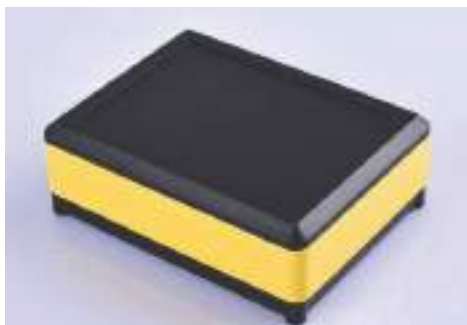

BAD 11019-D10-A2(W25)

126*96*25mm

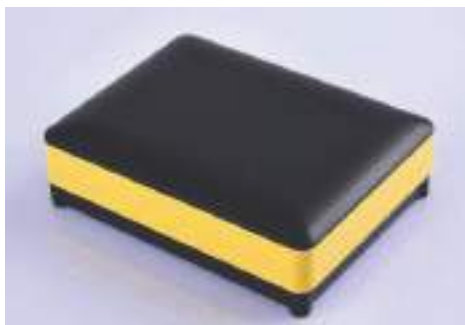

BAD 11019-D10-B2(W20)

126*96*20mm





BAD 11020-D10-B2(W50)

120*120*50mm

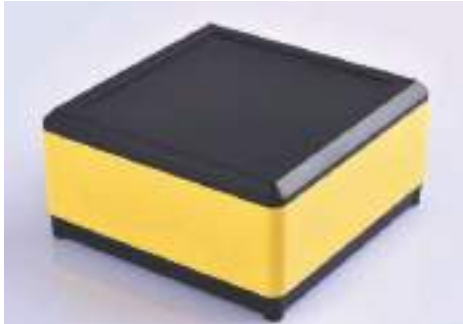

BAD 11020-D10-A2(W40)

120*120*40mm

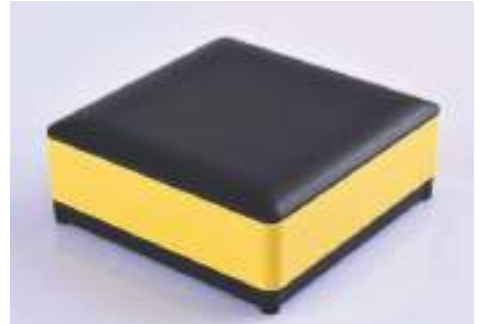

BAD 11020-D10-B2(W30)

120*120*30mm

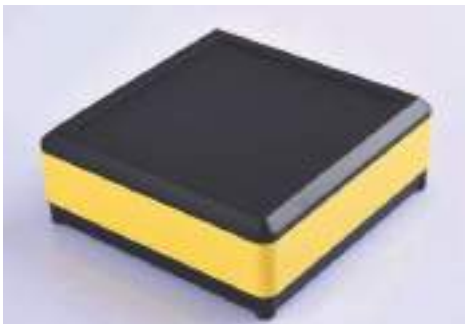

BAD 11020-D10-A2(W25)

120*120*25mm

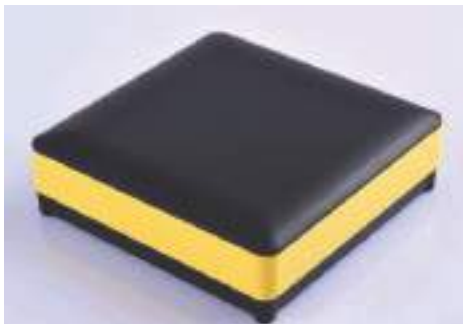

BAD 11020-D10-B2(W20)

120*120*20mm

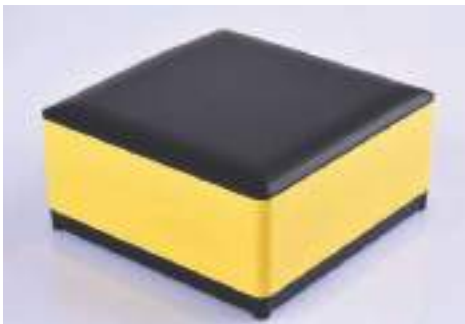

BAD 11021-D10-B2(W50)

140*140*50mm

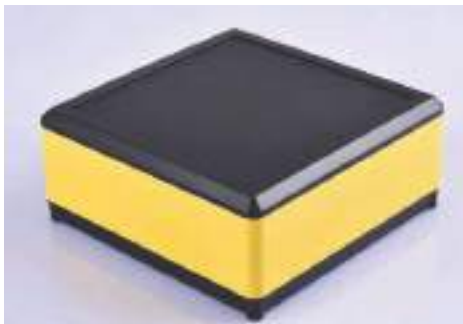

BAD 11021-D10-A2(W40)

140*140*40mm

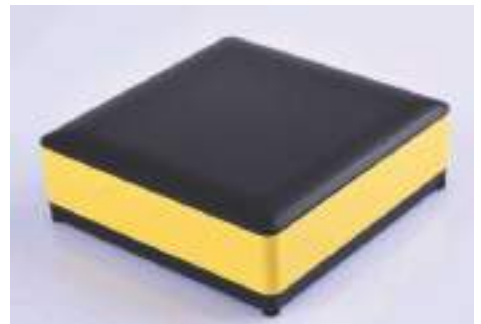

BAD 11021-D10-B2(W30)

140*140*30mm

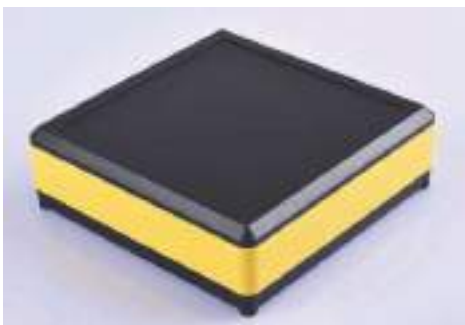

BAD 11021-D10-A2(W25)

140*140*25mm

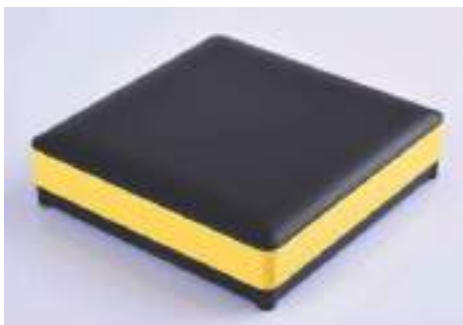

BAD 11021-D10-B2(W20)

140*140*20mm





BAD 11017-D2-B2(W50)

200*100*50mm



BAD 11017-D2-A2(W40)

200*100*40mm



BAD 11017-D2-B2(W30)

200*100*30mm



BAD 11017-D2-A2(W25)

200*100*25mm

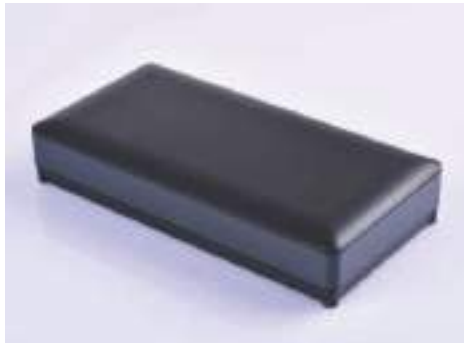

BAD 11017-D2-B2(W20)

200*100*20mm



BAD 11018-D2-B2(W50)

100*100*50mm



BAD 11018-D2-A2(W40)

100*100*40mm



BAD 11018-D2-B2(W30)

100*100*30mm

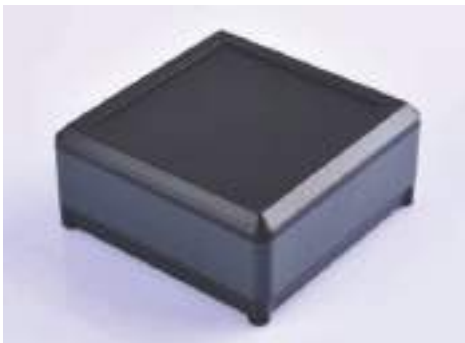

BAD 11018-D2-A2(W25)

100*100*25mm



BAD 11018-D2-B2(W20)

100*100*20mm





BAD 11019-D2-B2(W50)
126*96*50mm



BAD 11019-D2-A2(W40)
126*96*40mm



BAD 11019-D2-B2(W30)
126*96*30mm

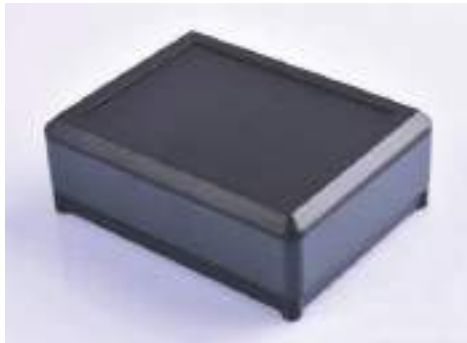

BAD 11019-D2-A2(W25)
126*96*25mm

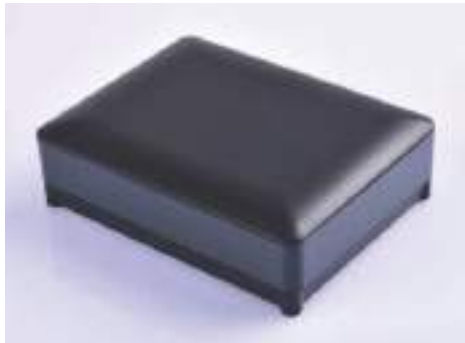

BAD 11019-D2-B2(W20)
126*96*20mm



BAD 11020-D2-B2(W50)
120*120*50mm



BAD 11020-D2-A2(W40)
120*120*40mm



BAD 11020-D2-B2(W30)
120*120*30mm

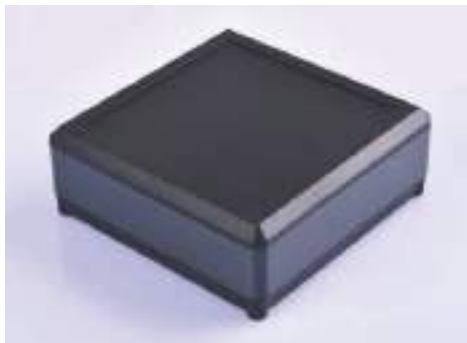

BAD 11020-D2-A2(W25)
120*120*25mm

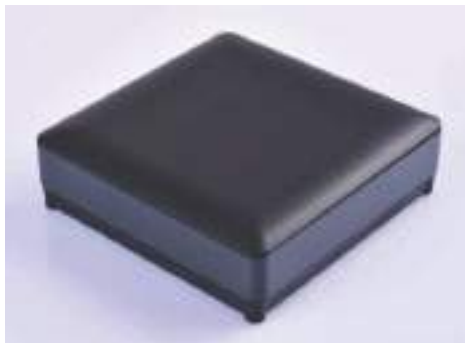

BAD 11020-D2-B2(W20)
120*120*20mm





BAD 11021-D2-B2(W50)

140*140*50mm

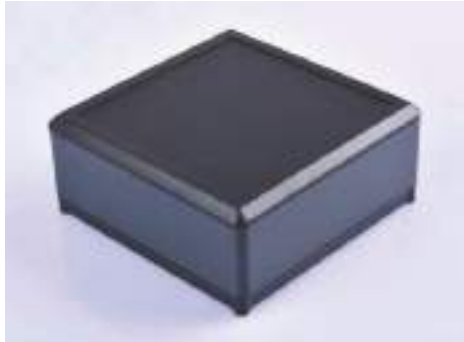

BAD 11021-D2-A2(W40)

140*140*40mm

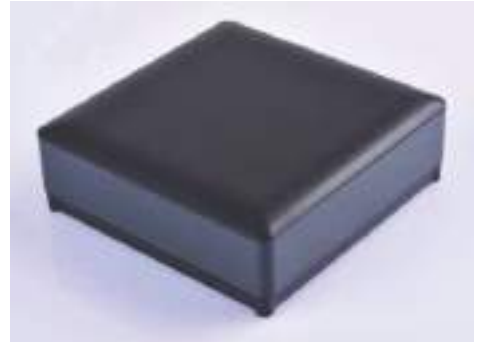

BAD 11021-D2-B2(W30)

140*140*30mm

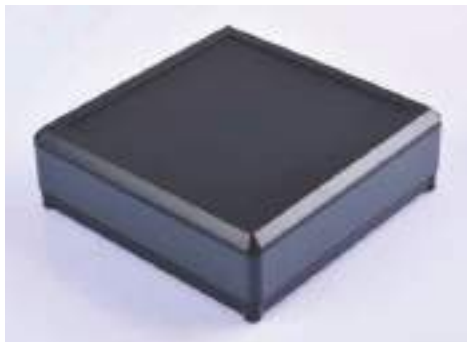

BAD 11021-D2-A2(W25)

140*140*25mm

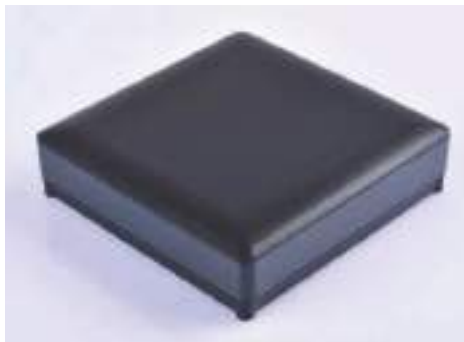

BAD 11021-D2-B2(W20)

140*140*20mm



BAD 11017-D2-B3(W40)

200*100*40mm



BAD 11017-D2-B3(W30)

200*100*30mm

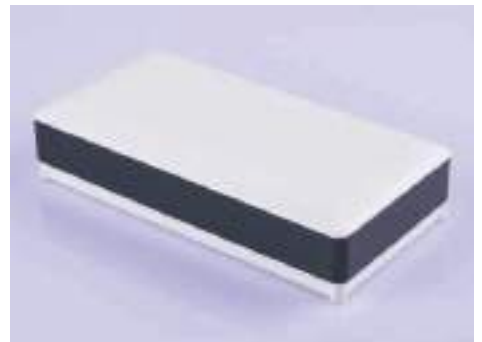

BAD 11017-D2-B3(W25)

200*100*25mm



BAD 11017-D2-B3(W20)

200*100*20mm



BAD 11017-D2-A3(W40)

200*100*40mm

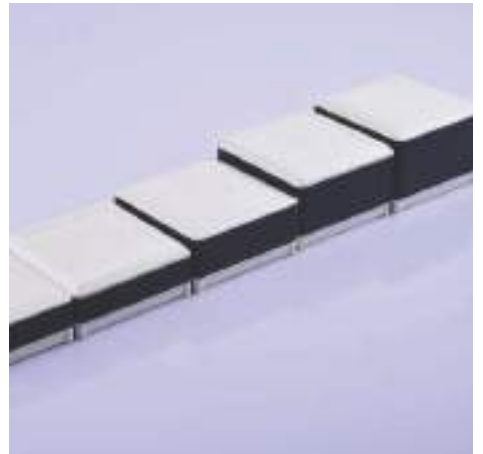
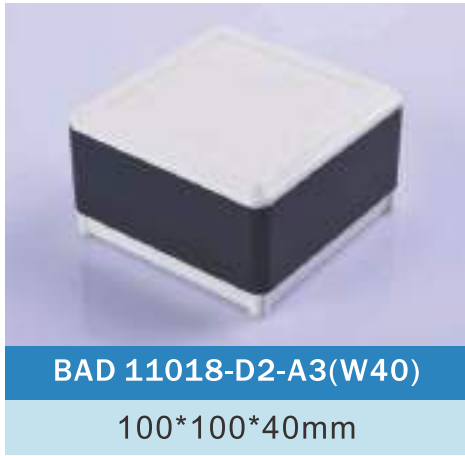
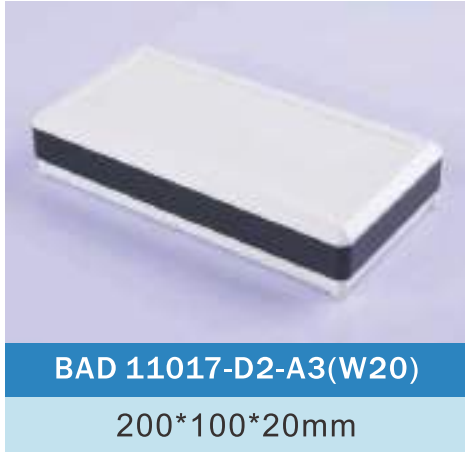

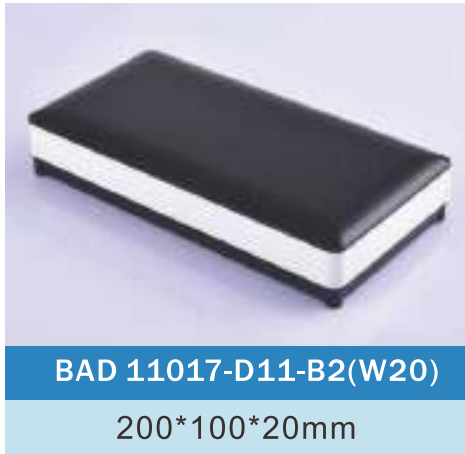
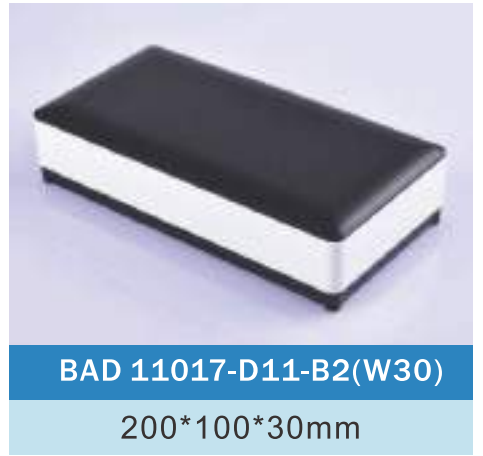
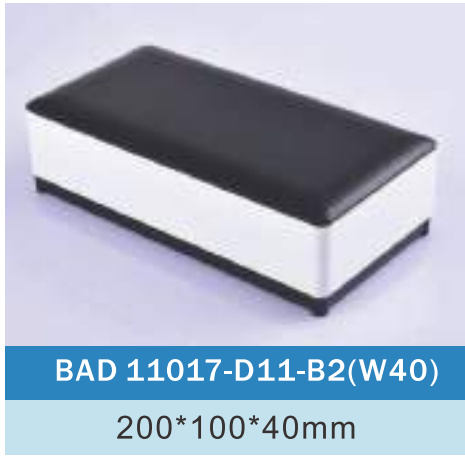
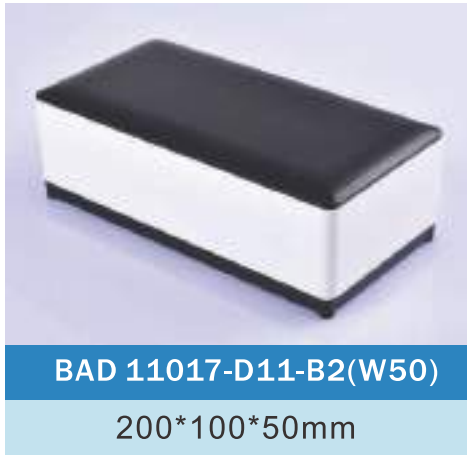
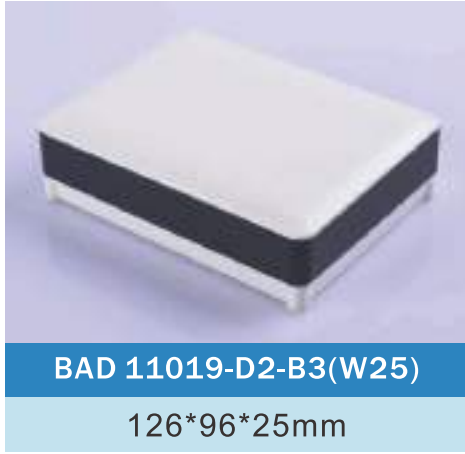

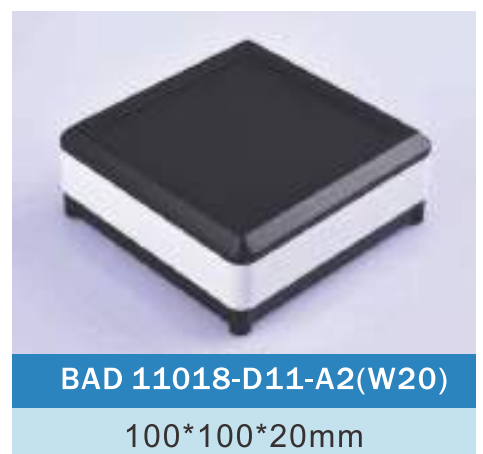
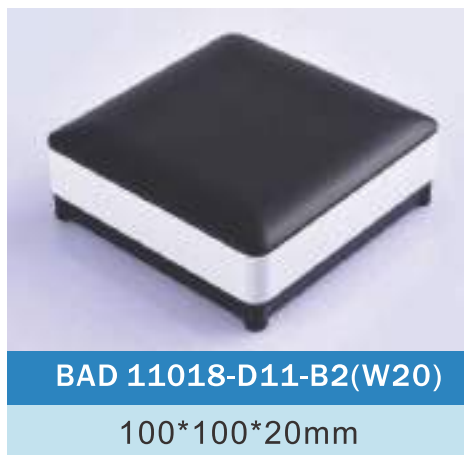
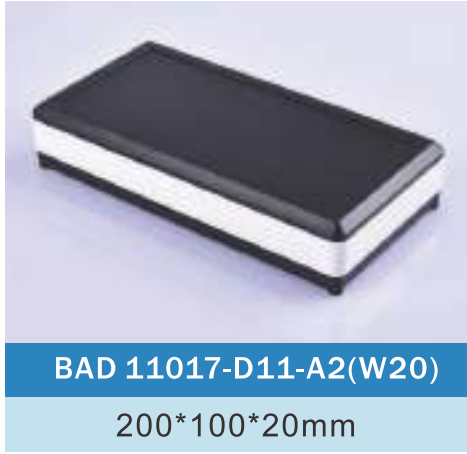



BAD 11019-D11-A2(W50)

126*96*50mm



BAD 11019-D11-A2(W40)

126*96*40mm



BAD 11019-D11-A2(W30)

126*96*30mm

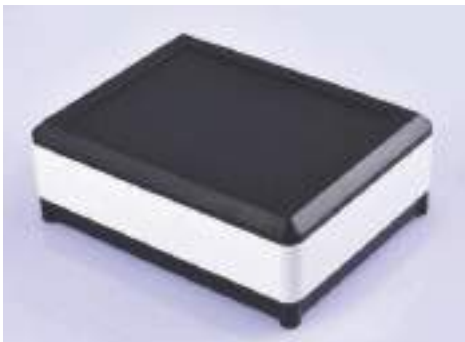

BAD 11019-D11-A2(W25)

126*96*25mm

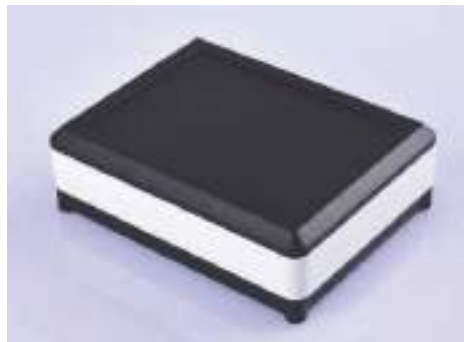

BAD 11019-D11-A2(W20)

126*96*20mm



BAD 11019-D11-B2(W50)

126*96*50mm



BAD 11019-D11-B2(W40)

126*96*40mm



BAD 11019-D11-B2(W30)

126*96*30mm



BAD 11019-D11-B2(W25)

126*96*25mm



BAD 11019-D11-B2(W20)

126*96*20mm

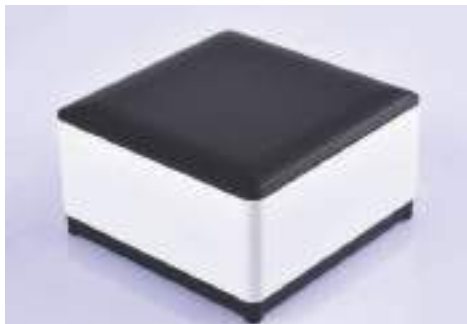

BAD 11020-D11-B2(W50)

120*120*50mm



BAD 11020-D11-B2(W40)

120*120*40mm

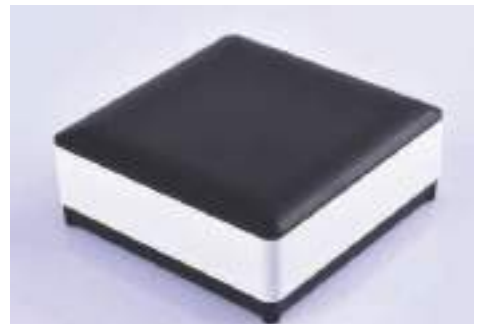

BAD 11020-D11-B2(W30)

120*120*30mm

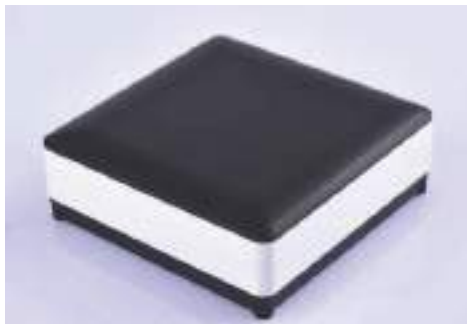

BAD 11020-D11-B2(W25)

120*120*25mm

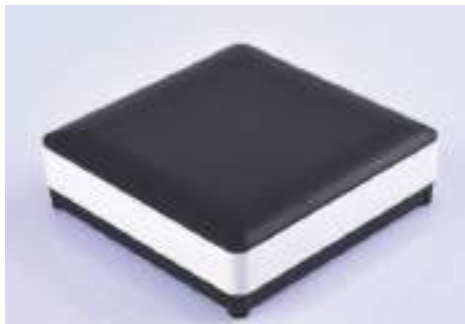

BAD 11020-D11-B2(W20)

120*120*20mm

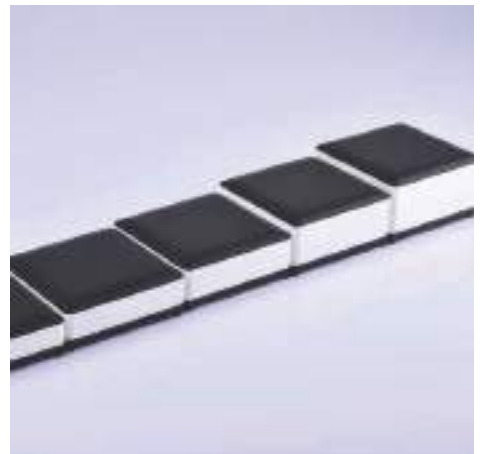

BAD 11020-D11-A2(W50)

120*120*50mm



BAD 11020-D11-A2(W40)

120*120*40mm

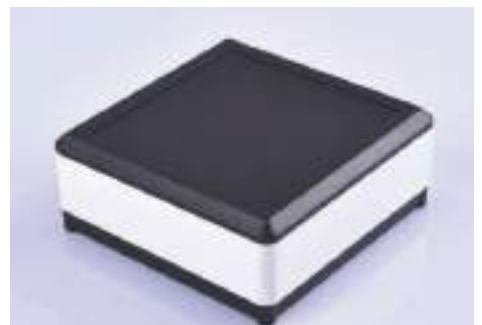

BAD 11020-D11-A2(W30)

120*120*30mm

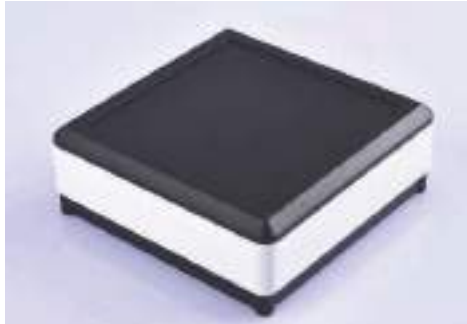

BAD 11020-D11-A2(W25)

120*120*25mm

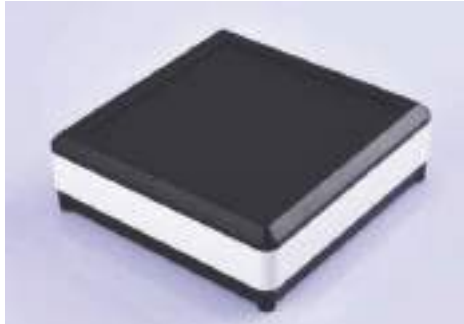

BAD 11020-D11-A2(W20)

120*120*20mm



BAD 11021-D11-B2(W50)

140*140*50mm

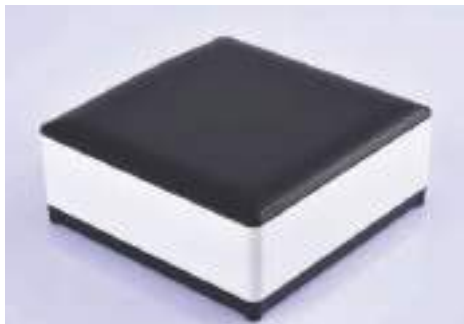

BAD 11021-D11-B2(W40)

140*140*40mm

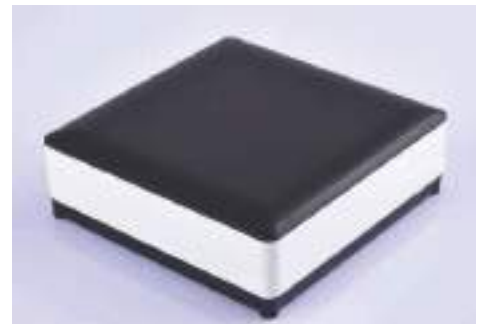

BAD 11021-D11-B2(W30)

140*140*30mm

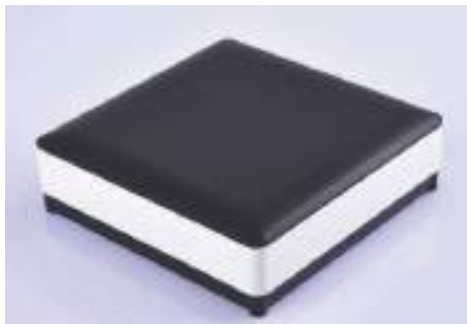

BAD 11021-D11-B2(W25)

140*140*25mm

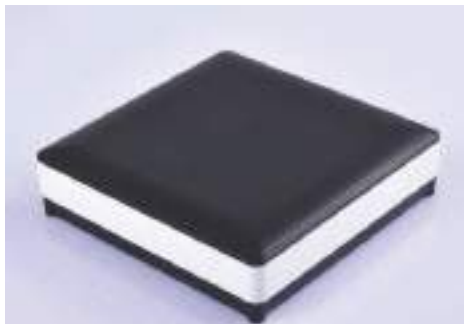

BAD 11021-D11-B2(W20)

140*140*20mm

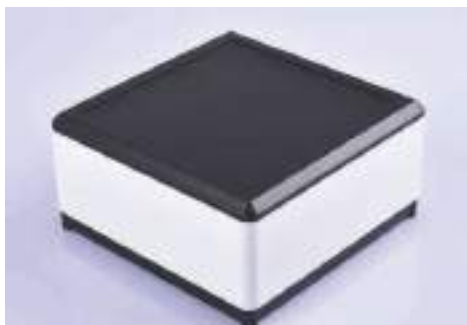

BAD 11021-D11-A2(W50)

140*140*50mm

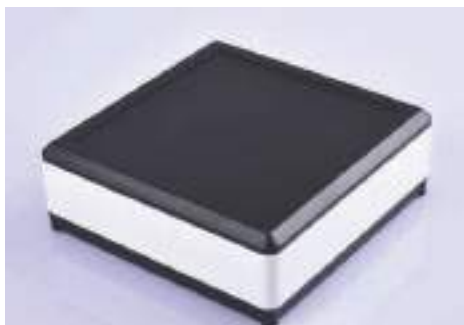

BAD 11021-D11-A2(W30)

140*140*30mm

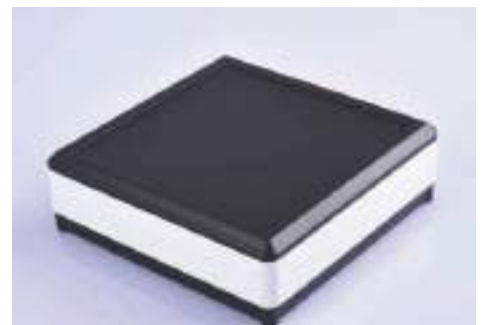

BAD 11021-D11-A2(W25)

140*140*25mm

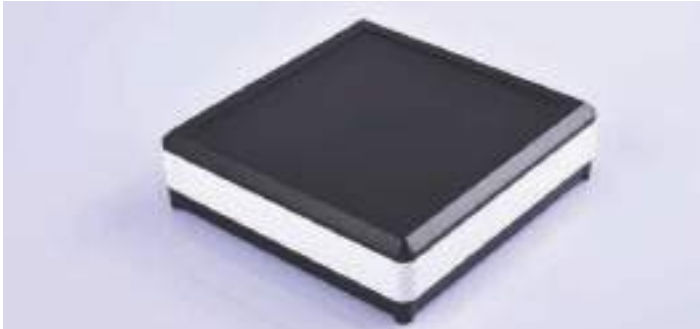

BAD 11021-D11-A2(W20)

140*140*20mm

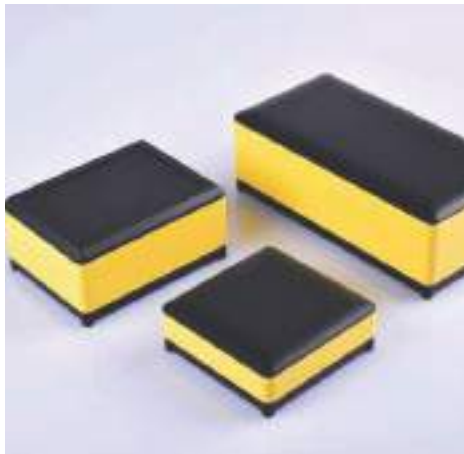



BAW 12019-M2-B2(W20)
126*96*20mm



BAW 12019-M3-B2(W20)
126*96*20mm



BAW 12019-M2-B3(W25)
126*96*25mm



BAW 12018-M2-B3(W30)
100*100*30mm



BAW 12020-M2-B3(W30)
120*120*30mm



BAW 12021-M2-B3(W25)
140*140*25mm





BAW 12017-Z11-A2(W25)

200*100*25mm



BAW 12018-Z11-A2(W25)

100*100*25mm



BAW 12019-Z11-A2(W25)

126*96*25mm



BAW 12022-Z11-B3(W25)

126*96*25mm



BAW 12022-Z2-B2(W25)

126*96*25mm













BDA 40090-A9

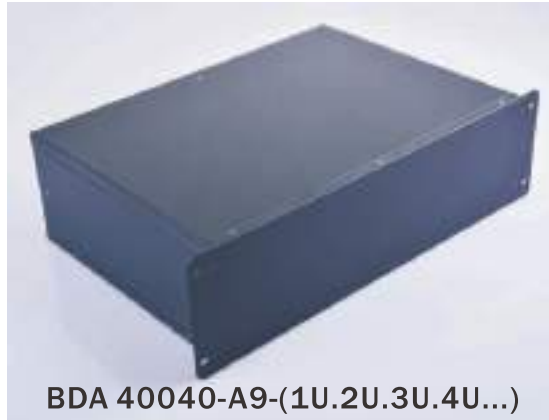

BDA 40040-A9-(1U.2U.3U.4U...)



BDA 40007



BDA 40004

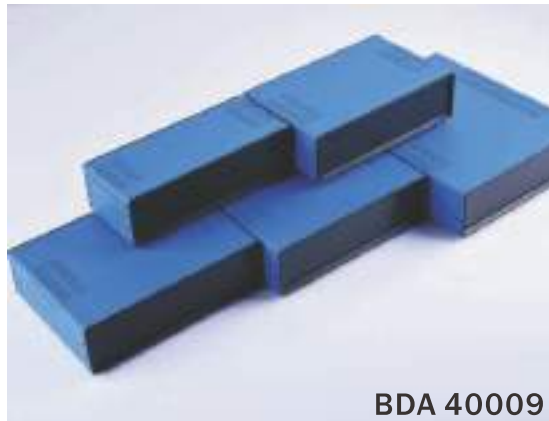

BDA 40009

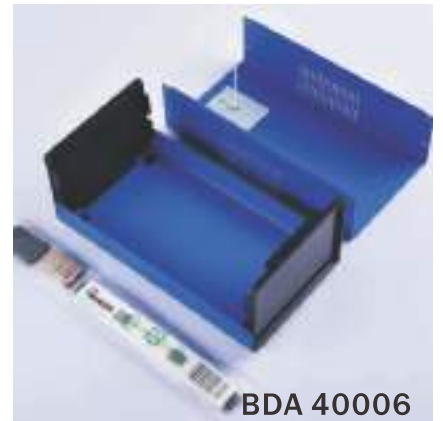

BDA 40006





KN-500 B-RED

φ 15X20.6mm



KN-500 B-YELLOW

φ 15X20.6mm



KN-500 B-BLUE

φ 15X20.6mm



KN-500 B-WHITE

φ 15X20.6mm



KN-500 B-GREEN

φ 15X20.6mm



KN-500 G-RED

φ 15X20.6mm



KN-500 G-YELLOW

φ 15X20.6mm



KN-500 G-BLUE

φ 15X20.6mm



KN-500 G-WHITE

φ 15X20.6mm



KN-500 G-GREEN

φ 15X20.6mm



BTS-0001(L220)

240x31x10.5mm



BP-10

φ 13mm



BP-16

φ 16mm



BP-20

φ 20mm



BP-30

φ 30mm

防水盒介绍 Introduction to water-proof moulds

- 1、密封圈采用一体式硅胶，具有高防水、高密封性；
- 2、壳体采用铜螺母、不锈钢螺丝；
- 3、配墙钉及墙钉螺丝；
- 4、螺丝位置加螺丝盖扣；
- 5、防水等级可达IP68；
- 6、产品独立包装。

1. Use of one sachet of silica gel for water-proof rings which is highly water-proof and highly sealed.
2. Use of copper bolts and stainless steel screws for the external body
3. Wall hanging nails and wall hanging screws
4. Screw spots with their covers
5. Water-proof level up to IP68
6. Exclusive package for each unit



服务与加工 Services and machining

- 1、模具制定及加工；
- 2、产品局部改动及加工；
- 3、产品材料和颜色可按要求定制；
- 4、产品改动、加工收取相应的改模费及加工费；
- 5、专业机器开孔。

1. Developing molds and its machining
2. Modification of the product and its machining
3. The material and color of the products can be modified as required.
4. Additional costs are added for modification and machining depending on the mould.
5. Professional machines for punching the Enclosure



产品包装 Product packaging

