



T W I L I G H T

Series

BY MASTER SPAS

OWNER'S MANUAL

MASTER SPAS TWILIGHT OWNER'S MANUAL

Welcome To Ultimate Relaxation!

Thank you for choosing your new spa built by Master Spas. Please read the entire Owner's Manual before installing and using your spa. The goal of this manual is to provide you with safety and operational information plus some tips that will help you enjoy your spa to its fullest.

At the time of print, this manual is accurate in its information. Master Spas reserves the right to change or improve its product without prior notice. To check on updates or for other information, please visit www.masterspas.com and follow the links to the customer service section.

RECORD OF OWNERSHIP

Name _____

Address _____

City _____ State _____ Zip _____

Date Purchased ____ / ____ / ____

Model _____ Serial # _____

Dealer Name _____

Phone # (____) _____ - _____

Service Tech Rep _____

*SERIAL NUMBER LOCATION

The serial number for your spa is located in the filter area, on the spa system pack, or on the listing plate on the skirting. It is a seven digit number. **Ex. 1445900**



MASTER SPAS®

6927 Lincoln Parkway

Fort Wayne, Indiana 46804

800-860-7727 • www.masterspas.com

TABLE OF CONTENTS

Safety Instructions	3-10
Glossary of Spa Terminology	11
Electrical Requirements	12-13
Wiring Schematic	14
Site Preparation / General Guidelines.....	15-16
Installation Instructions	17
Water Chemistry Terms You Should Know	18-19
Spa Water Maintenance	
The Advantages of Eco Pur Filtration	20
Water Quality Maintenance Start-Up	21
Water Quality Maintenance Schedule – ECO PUR.....	22-23
Water Maintenance Trouble-Shooting Guide	24
Why Chemicals are Important in a Spa	25
Maintenance Recommendations	26-27
Winterizing Your Spa	28
Twilight Spa Specifications	29
Twilight Spa Controls	
TS 6.1, TS 67.15, TS 7.1, TS 7.15	30-39
Twilight Spa Controls	
TS 6.2, TS 67.25, TS 7.2, TS 7.25, TS 8.2, TS 8.25, TS 8.3, TS 8.35, TS Fit, TS 240.....	40-42
Twilight Spa Controls	
TS Fit.....	43-60
Twilight Spa Controls	
TS 120.....	61-62
Standard Fusion Audio System	63
Deluxe Fusion Audio System	64-65
Spa Trouble-Shooting Guide	66-67
Regular Maintenance Procedures	68-70
Mast3rpur	71-73
WiFi Operation and TS Fit Only	74
Spa Care and Maintenance Record	75-76

SAFETY INSTRUCTIONS

SAVE THESE INSTRUCTIONS

Included with your new spa is a safety sign. The sign is for you and your guest's protection and is suitable for outdoor use in wet locations. The sign should be placed in a location visible to all users of the spa.

Please take time to point out the physical location of the safety sign and the importance of the safety precautions displayed on the safety sign to all of your guests. Remember, your safety and the safety of anyone who enjoys the use of your spa is our utmost concern.

The sign should be mounted with screws or another type of permanent fastener. Additional or replacement signs can be obtained from your dealer or direct from the factory.

INTRODUCTION

It's time to relax! You now have your very own portable spa by Master Spas, Inc. By fully understanding the operation of each of the features of your new Master Spa, you will be assured of many years of hassle-free, hot water therapy and fun.

Your safety is of paramount importance to the Master Spas family. We urge you to read and become thoroughly familiar with all safety aspects addressed in this manual.

Through reading and totally understanding the important information in your owner's manual, you will realize that you now own **THE ULTIMATE RELAXATION MACHINE!**

NO DIVING

**DANGER: DIVING MAY
RESULT IN SERIOUS
INJURY OR DEATH.**



IMPORTANT SAFETY INSTRUCTIONS

When installing and using this electrical equipment, basic safety precautions should be observed including the following:

READ AND FOLLOW ALL INSTRUCTIONS

WARNING – To reduce the risk of injury, do not permit children to use this product unless they are closely supervised at all times.

A wire conductor is provided on this unit to connect a minimum 6 AWG (13.302mm²) solid copper conductor between this unit and any metal equipment, metal enclosures of electrical equipment, metal water pipe, or conduit within 5 feet (1.5m) of the unit

(For cord-connected/convertible units)

DANGER – Risk of injury.

- a) Replace damaged cord immediately.
- b) Do not bury cord.
- c) Connect to a grounded, grounding type receptacle only.

(For units intended for indoor use only)

WARNING – For indoor use only. This unit is not intended for outdoor use.

(For units intended for outdoor use only)

WARNING – For outdoor use only. This unit is not intended for indoor use.

NO DIVING

**DANGER: DIVING MAY
RESULT IN SERIOUS
INJURY OR DEATH.**



IMPORTANT SAFETY INSTRUCTIONS (CONT.)

(For units with GFCI)

WARNING – This product is provided with a ground-fault circuit interrupter located on the front panel of selected swim spas and on the power cord of 120 volt convertible spas. The GFCI must be tested before each use. With the product operating, open the service door. When the product stops operating, this merely indicates that the door is equipped with an electrical interlock. Next, push the test button on the GFCI and close the service door. The product should not operate. Now open the service door, push the reset button on the GFCI and close the service door. The product should now operate normally. When the product fails to operate in this manner, there is a ground current flowing indicating the possibility of an electric shock. Disconnect the power until the fault has been identified and corrected.

DANGER – Risk of Accidental Drowning. Extreme caution must be exercised to prevent unauthorized access by children. To avoid accidents, ensure that children cannot use this spa unless they are supervised at all times.

DANGER – Risk of Injury. The suction fittings in this spa are sized to match the specific water flow created by the pump. Should the need arise to replace the suction fittings or the pump, be sure that the flow rates are compatible.

Never operate spa if the suction fittings are broken or missing. Never replace a suction fitting with one rated less than the flow rate marked on the original suction fitting.

DANGER – Risk of Electric Shock. Install at least 5 feet (1.5m) from all metal surfaces. As an alternative, a spa may be installed within 5 feet of metal surfaces if each metal surface is permanently connected by a minimum 8AWG (8.4mm²) solid copper conductor to the wire connector on the terminal box that is provided for this purpose.

DANGER – Risk of Electric Shock. Do not permit any electric appliance, such as a light, telephone, radio, or television, within 5 feet (1.5 m) of a spa.

WARNING – To reduce the risk of injury:

- a) The water in a spa should never exceed 40°C (104°F). Water temperatures between 38°C (100°F) and 40°C are considered safe for a healthy adult. Lower water temperatures are recommended for young children and when spa use exceeds 10 minutes.

NO DIVING

**DANGER: DIVING MAY
RESULT IN SERIOUS
INJURY OR DEATH.**



IMPORTANT SAFETY INSTRUCTIONS (CONT.)

- b) Since excessive water temperatures have a high potential for causing fetal damage during the early months of pregnancy, pregnant or possibly pregnant women should limit spa water temperatures to 38°C (100°F).
- c) Before entering a spa, the user should measure the water temperature since the tolerance of water temperature- regulating devices varies.
- d) The use of alcohol, drugs, or medication before or during spa use may lead to unconsciousness with the possibility of drowning.
- e) Obese persons and persons with a history of heart disease, low or high blood pressure, circulatory system problems, or diabetes should consult a physician before using a spa.
- f) Persons using medication should consult a physician before using a spa since some medication may induce drowsiness while other medication may affect heart rate, blood pressure, and circulation.

(For spas with a gas heater)

WARNING – Risk of Suffocation. This spa is equipped with a gas heater and is intended for outdoor use only unless proper ventilation can be provided for an indoor installation.

HYPERTHERMIA

Hyperthermia occurs when the internal temperature of the body reaches a level several degrees above the normal body temperature of 98.6° F.

THE SYMPTOMS OF HYPERTHERMIA INCLUDE:

- Dizziness • Fainting • Drowsiness • Lethargy
- Increase in Internal Body Temperature

THE EFFECTS OF HYPERTHERMIA INCLUDE:

Unawareness of Impending Hazard • Failure to Perceive Heat • Failure to Recognize the Need to Exit Spa • Physical Inability to Exit Spa • Fetal Damage in Pregnant Women • Unconsciousness Resulting in a Danger of Drowning

NO DIVING

**DANGER: DIVING MAY
RESULT IN SERIOUS
INJURY OR DEATH.**



IMPORTANT SAFETY INSTRUCTIONS (CONT.)

DANGER – To reduce the risk of injury to persons, do not remove the suction grate. Suction through drains and skimmers is powerful when the jets in the spa are in use. Damaged covers can be hazardous to small children and adults with long hair. Should any part of the body be drawn into these fittings, turn off the spa immediately. As a precaution, long hair should not be allowed to float in the spa.

WARNING – Install the spa so that water can be easily drained out of the compartment containing electrical components so as not to damage equipment. When installing the spa make sure to allow for an adequate drainage system to deal with any overflow water. Please allow for at least 2 feet of clearance around the perimeter of the spa to provide enough room to access for servicing. Contact your local dealer for their specific requirements.

WARNING – The spa should be covered with an approved locking cover when not in use, to prevent unauthorized entry and injuries.

WARNING – People with infections, sores or the like should not use the spa. Warm and hot water temperatures may allow the growth of infectious bacteria if not properly disinfected.

CAUTION – Safe temperatures for swimming or aquatic exercise is around 80°F.

CAUTION – Risk of Electrical Shock. Do not leave audio compartment open. Audio controls are not to be operated while inside the spa.

CAUTION – Replace components only with identical components.

WARNING – Risk of Electric Shock. Do not connect any auxiliary components (for example, additional speakers, headphones, additional audio/ video components etc.) to the system. These units are not provided with an outdoor antenna.

Do not service this product yourself as opening or removing covers may expose you to dangerous voltage or other hazards. Refer all servicing to qualified service personnel.

If the power supply cord(s) are damaged, water is entering the speaker, audio compartment, or any other component in the electrical equipment compartment area, the protective shield is showing signs of deterioration, or there are signs of other potentially hazardous damage to the unit, turn off the circuit breaker from the wall and refer servicing to qualified personnel.

NO DIVING

**DANGER: DIVING MAY
RESULT IN SERIOUS
INJURY OR DEATH.**



IMPORTANT SAFETY INSTRUCTIONS (CONT.)

The unit should be subjected to periodic routine maintenance once every quarter to make sure that the it is operating properly.

DANGER – Risk of Electric Shock. A green colored terminal or a terminal marked G, GR, Ground, Grounding or the symbol shown in Figure 14.1 of UL 1563 is located inside the supply terminal box or compartment. To reduce the risk of electric shock, this terminal must be connected to the grounding means provided in the electric supply service panel with a continuous copper wire equivalent in size to the circuit conductors supplying this equipment.

At least two lugs marked “Bonding Lugs” are provided on the external surface or on the inside of the supply terminal box or compartment. To reduce the risk of electric shock, connect the local common bonding grid in the area of the spa to these terminals with an insulated or bare copper conductor not smaller than 8AWG.

All field installed metal components such as rails, ladders, drains, or other similar hardware within 3m of the spa shall be bonded to the equipment grounding bus with copper conductors not smaller than 8AWG.

SAVE THESE INSTRUCTIONS

SAFETY INSTRUCTIONS

WARNING: CHILDREN SHOULD NOT USE SPAS OR HOT TUBS WITHOUT ADULT SUPERVISION

AVERTISSEMENT: NE PAS LAISSER LES ENFANTS UTILISER UNE CUVE DE RELAXATION SANS SURVEILLANCE

WARNING: DO NOT USE SPAS OR HOT TUBS UNLESS ALL SUCTION GUARDS ARE INSTALLED TO PREVENT BODY AND HAIR ENTRAPMENT.

AVERTISSEMENT: POUR ÉVITER QUE LES CHEVEUX OU UNE PARTIE DU CORPS PUISSENT ÊTRE ASPIRES, NE PAS UTILISER UNE CUVE DE RELAXATION SI LES GRILLES DI PRISE D'ASPIRATION NE SONT PAS TOUTES EN PLACE

WARNING: PEOPLE USING MEDICATIONS AND/OR HAVING AN ADVERSE MEDICAL HISTORY SHOULD CONSULT A PHYSICIAN BEFORE USING A SPA OR HOT TUB.

AVERTISSEMENT: LES PERSONNES QUI PRENNENT DES MÉDICAMENTS OU ONT DES PROBLÈMES DE SANTÉ DEVRAIENT CONSULTER UN MÉDECIN AVANT D'UTILISER UNE CUVE DE RELAXATION

WARNING: PEOPLE WITH INFECTIOUS DISEASES SHOULD NOT USE A SPA OR HOT TUB

AVERTISSEMENT: LES PERSONNES ATTEINTES DE MALADIES INFECTIEUSES NE DEVRAIENT PAS UTILISER UNE CUVE DE RELAXATION

WARNING: TO AVOID INJURY EXERCISE CARE WHEN ENTERING OR EXITING THE SPA OR HOT TUB.

AVERTISSEMENT: POUR ÉVITER DES BLESSURES, USER DE PRUDENCE EN ENTRANT DANS UNE CUVE DE RELAXATION ET EN SORTANT

WARNING: DO NOT USE DRUGS OR ALCOHOL BEFORE OR DURING THE USE OF A SPA OR HOT TUB TO AVOID UNCONSCIOUSNESS AND POSSIBLE DROWNING

AVERTISSEMENT: POUR ÉVITER L'ÉVANOUISSEMENT ET LA NOYADE ÉVENTUELLE, NE PRENDE NI DROGUE NI ALCOOL AVANT D'UTILISER UNE CUVE DE RELAXATION NI QUAND ON S'Y TROUVE

WARNING: PREGNANT OR POSSIBLY PREGNANT WOMEN SHOULD CONSULT A PHYSICIAN BEFORE USING A SPA OR HOT TUB.

AVERTISSEMENT: LES FEMMES ENCEINTES, QUE LEUR GROSSESSE SOIT CONFIRMÉE OU NON, DEVRAIENT CONSULTER UN MÉDECIN AVANT D'UTILISER UNE CUVE DE RELAXATION

WARNING: WATER TEMPERATURE IN EXCESS OF 38°C MAY BE INJURIOUS TO YOUR HEALTH

AVERTISSEMENT: IL PEUT ÊTRE DANGEREUX POUR LA SANTÉ DE SE PLONGER DANS DE L'EAU A PLUS DE 38°C

SAFETY INSTRUCTIONS

WARNING: BEFORE ENTERING THE SPA OR HOT TUB MEASURE THE WATER TEMPERATURE WITH AN ACCURATE THERMOMETER

AVERTISSEMENT: AVANT D'UTILISER UNE CUVE DE RELAXATION MESURER LA TEMPÉRATURE DE L'EAU À L'AIDE D'UN THERMOMÈTRE PRÉCIS

WARNING: DO NOT USE A SPA OR HOT TUB IMMEDIATELY FOLLOWING STRENUOUS EXERCISE

AVERTISSEMENT: NE PAS UTILISER UNE CUVE DE RELAXATION IMMÉDIATEMENT APRÈS UN EXERCISE FATIGANT

WARNING: PROLONGED IMMERSION IN A SPA OR HOT TUB MAY BE INJUROUS TO YOUR HEALTH

AVERTISSEMENT: L'UTILISATION PROLONGÉE D'UNE CUVE DE RELAXATION PEUT ÊTRE DANGEREUSE POUR LA SANTÉ

WARNING: DO NOT PERMIT ELECTRIC APPLIANCES (SUCH AS LIGHT, TELEPHONE, RADIO, OR TELEVISION) WITHIN 1.5 M OF THIS SPA OR HOT TUB

AVERTISSEMENT: NE PAS PLACER D'APPAREIL ÉLECTRIQUE (LUMINAIRE, TÉLÉPHONE, RADIO, TÉLÉVISEUR, ETC) À MOINS DE 1.5 M DE CETTE CUVE DE RELAXATION

CAUTION: MAINTAIN WATER CHEMISTRY IN ACCORDANCE WITH MANUFACTURER'S INSTRUCTION

ATTENTION: LA TENEUR DE L'EAU EN MATIÈRES DISSOUTES DOIT ÊTRE CONFORME AUX DIRECTIVES DU FABRICANT

Hyperthermia occurs when the internal temperature of the body reaches a level several degrees above the normal body temperature of 37°C. The symptoms of hyperthermia include drowsiness, lethargy, and an increase in the internal temperature of the body. The effects of hyperthermia include

- (a) unawareness of impending hazard;
- (b) failure to perceive heat;
- (c) failure to recognize the need to exit spa;
- (d) physical inability to exit spa;
- (e) fetal damage in pregnant women; and
- (f) unconsciousness and danger of drowning.

WARNING: THE USE OF ALCOHOL OR DRUGS CAN GREATLY INCREASE THE RISK OF FATAL HYPERTHERMIA IN HOT TUBS AND SPAS

LA CONSOMMATION D'ALCOOL OU DE DROGUE AUGMENTE CONSIDÉRABLEMENT LES RISQUES D'HYPERTHERMIE MORTELLE DANS UNE CUVE DE RELAXATION.

GLOSSARY OF SPA TERMINOLOGY



- 1. DRAINING YOUR SPA.** The drain is located behind the front panel on the far right side. You can access the drain by unscrewing the corner screws and removing the corner panel. Grasp the drain cap, and pull the assembly out all the way. Unscrew the cap, and push the assembly back in half way to start the flow of water. Attach a garden hose, if desired. Draining times may vary by model using the external hose bib. A sump pump may also be used to drain the spa quickly. NOTE: When pushing or pulling the assembly in or out, water will drip from the drain during the transition. This is normal.

Due to the shape of the TS 120 and TS 240 this type of drain is not fitted on either of these spas. The drain in these spas is located inside of the front panel of the spa. See page 68 for details.

The TS Fit does not have a conventional pull out drain as shown above. Due to the physical size of the TS Fit, we recommend draining this spa with a submersible sump pump. Draining this spa with a conventional spa drain is not a reasonable option.

- 2. JETS 1 PUMP.** This pump produces water flow through the main jets in the spa. This pump may be operated on two speeds. The low speed will produce efficient water circulation and gentle jet action. High speed should be used for maximum jet action. In spas not equipped with a 24 hour circulation pump, this pump also moves water for the heat and filtration cycles.
- 3. JETS 2 PUMP.** (If so equipped) This produces water flow through the designated jets and has only one speed.
- 4. JETS 3 PUMP.** (If so equipped) This produces water flow though the designated jets and has one speed.
- 5. CIRCULATION PUMP.** (If so equipped) This pump runs 24 hours a day and moves water for heating and filtration. Spas equipped with this pump do not have filtration cycles as they are not necessary in this configuration.
- 6. JET DIVERTER VALVE.** Located on the topside of the spa, this valve physically diverts the flow of water from one jet zone of the spa to another jet zone. Be sure that no sand or particles are brought into the spa as they will cause the diverter to seize up. It is best to turn the diverter valve only when the pump is turned off.
- 7. PUMP UNION.** These are used by service personnel to easily service the jet pump(s).
- 8. HEATER UNION.** These are used by service personnel to easily service the spa heater assembly.
- 9. OZONATOR.** Your ozone generator will operate in conjunction with your filtration system.
- 10. MAST3RPUR.** Your optional U/V ozone generator operates with the 24 hour circulation pump (if so equipped) to help sanitize the water.

ELECTRICAL INSTALLATION REQUIREMENTS

For TS 120 Only

HAVE YOUR ELECTRICIAN READ THE FOLLOWING INFORMATION BEFORE INSTALLATION BEGINS

Electrical connections made improperly, or the use of wire gauge sizes for incurring power which are too small, may continually blow fuses in the electrical equipment box, may damage the internal electrical controls and components, may be unsafe and in any case will void your warranty.

It is the responsibility of the spa owner to ensure that electrical connections are made by a qualified electrician in accordance with the National Electrical Code and any local and state electrical codes in force at the time of installation.

These connections must be made in accordance with the wiring diagrams found inside the control box. This equipment has been designed to operate on 60Hz. alternating current only, 120 volts are required. Make sure that power is not applied while performing any electrical installation. A copper bonding lug has been provided on the electrical equipment pack to allow connection to local ground points. The ground wire must be at least 14 AWG copper wire (unless local or state codes require a heavier gauge wire) and must be connected securely to a grounded metal structure such as a cold water pipe. All equipment packs are wired for 120 VAC only. The only electrical supply for your spa must include a 15 AMP switch or circuit breaker to open all non-grounded supply conductors to comply with section 422-20 of the National Electrical Code. The disconnect must be readily accessible to the spa occupants, but installed at least five feet from the spa. A Ground-Fault Circuit Interrupter (GFCI) (provided with the spa) must be used to comply with section 680-42 of the National Electrical Code. A ground fault is a current leak from any one of the supply conductors to ground. A GFCI is designed to automatically shut off power to a piece of equipment when a ground fault is detected.

Power hook-up to the spa must be 120 volt 2 wire plus ground (14 AWG copper).

Route the cable into the equipment area for final hook-up to terminals inside the control panel. The spa must be hooked up to a "dedicated" 120 volt, 15 amp. The term "dedicated" means the electrical circuit for the spa is not being used for any other electrical items (patio lights, appliances, garage circuits, etc.). If the spa is connected to a non-dedicated circuit, overloading will result in "nuisance tripping" which requires resetting of the breaker switch at the house electrical panel.

Rev. 11/07

Permanently Connected Equipment Assembly with Pump(s), Heaters, Luminance, Ozone, Spa Side Control(s), Pump shut off device.

NOTE: Some of the above components may be optional or not available with every spa model.

ELECTRICAL INSTALLATION REQUIREMENTS

For All Models Except TS 120

HAVE YOUR ELECTRICIAN READ THE FOLLOWING INFORMATION BEFORE INSTALLATION BEGINS

Electrical connections made improperly, or the use of wire gauge sizes for incurring power which are too small, may continually blow fuses in the electrical equipment box, may damage the internal electrical controls and components, may be unsafe and in any case will void your warranty.

It is the responsibility of the spa owner to ensure that electrical connections are made by a qualified electrician in accordance with the National Electrical Code and any local and state electrical codes in force at the time of installation.

These connections must be made in accordance with the wiring diagrams found inside the control box. This equipment has been designed to operate on 60Hz. alternating current only, 240 volts are required. Make sure that power is not applied while performing any electrical installation. A copper bonding lug has been provided on the electrical equipment pack to allow connection to local ground points. The ground wire must be at least 8 AWG copper wire (unless local or state codes require a heavier gauge wire) and must be connected securely to a grounded metal structure such as a cold water pipe. All Master Spas equipment packs are wired for 240 VAC only. The only electrical supply for your spa must include a 50 AMP switch or circuit breaker to open all non-grounded supply conductors to comply with section 422-20 of the National Electrical Code. The disconnect must be readily accessible to the spa occupants, but installed at least five feet from the spa. A Ground-Fault Circuit Interrupter (GFCI) must be used to comply with section 680-42 of the National Electrical Code. A ground fault is a current leak from any one of the supply conductors to ground. A GFCI is designed to automatically shut off power to a piece of equipment when a ground fault is detected.

Power hook-up to the spa must be 240 volt 3 wire plus ground (6 AWG copper) 8 AWG copper ground wire.

Route the cable into the equipment area for final hook-up to terminals inside the control panel. The spa must be hooked up to a "dedicated" 240 volt, 50 amp breaker and GFCI. The term "dedicated" means the electrical circuit for the spa is not being used for any other electrical items (patio lights, appliances, garage circuits, etc.). If the spa is connected to a non-dedicated circuit, overloading will result in "nuisance tripping" which requires resetting of the breaker switch at the house electrical panel. *Rev. 11/11*

Permanently Connected Equipment Assembly with Pump(s), Heaters, Luminaine, Ozone, Spa Side Control(s), Pump shut off device, and Audio/Video Components.

NOTE: Some of the above components may be optional or not available with every spa model.

WIRING SCHEMATIC - 240 VOLT SPA HOOK-UP



Wire Key

- Green (Ground)
- Red (Hot)
- Black (Hot)
- White (Neutral)

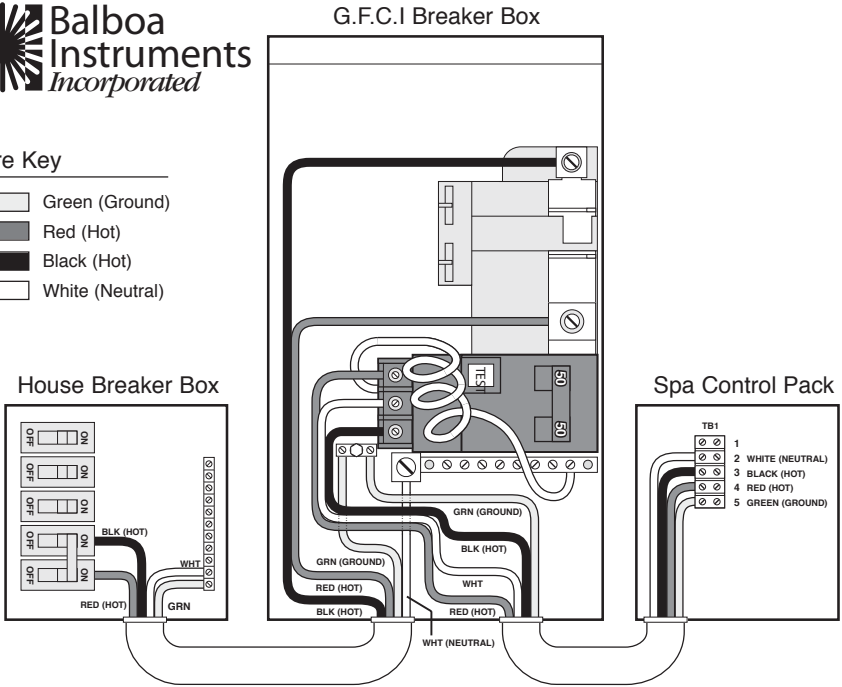

IDF00007.mac 6/17/97

** Actual wiring of GFCI will vary by manufacturer of GFCI. The GFCI shown is a Square D. Improper wiring of GFCI may result in permanent damage to spa spa control pack. Repair / replacement of spa system box is not covered under warranty when damage results from improper wiring. Actual wire attachment points on the Spa Control Pack may vary. Always refer to the wiring diagram inside the Spa Control Pack for proper power connection.*

SITE PREPARATION / GENERAL GUIDELINES

Portable spa installation is simple when properly planned. To that end, it is important that you read the following information carefully and consult with your Master Spas dealer.

- 1) **Access** - The actual dimensions of your new spa will determine the amount of space that is needed in moving the spa from curbside to its final installation area. Be sure to measure side yard dimensions, gates or doors and vertical obstructions such as roof overhangs and overhead cables. Any other space limiting obstacles such as trees or shrubs must be evaluated.
- 2) **If the spa is being installed indoors**, dimension limitations such as stairs, ceilings and walls must be taken into consideration. Please have your Master Spas dealer or delivery service review site or installation plans prior to delivery.
- 3) **Surface/Pad Requirements** - When your new spa is filled with water and bathers, it may weigh as much as several tons. It is imperative that the base beneath the spa can support the entire weight. The spa must be on a uniformly firm, continuous, and level surface. The recommended foundation is a concrete pad with a minimum thickness of four (4) inches with steel reinforcement bars crossed throughout the pad.
- 4) **GFCI (For TS 120 only)** - Your spa is equipped with a 15 amp GFCI cord that must be plugged into a dedicated 15 amp electrical outlet. This cord is located inside the spa behind the front skirt panel. Before operating the spa first remove the cord by cutting the plastic ties that secure it during shipping. Bring the cord outside of the spa and insert the cord in the "U" shaped channel provided below the front skirt panel area. **Note: For Canadian spas the GFCI cord is not attached to the equipment pack and will have to be attached by a licensed electrician.**

IMPORTANT

When installing your spa indoors, on a wood deck, or balcony, the same load requirements must be met. Total load may be as much as 90 pounds per square foot. You should speak with a qualified contractor or your local building department to confirm that your surface is adequate for supporting a spa. Be sure to locate your spa so that equipment remains above grade and is not subject to flooding.

The equipment side(s) of the spa must be accessible in the event that future service is needed. Periodical maintenance checks require entry into the equipment bay. When possible, it is wise planning for the future to leave 2 feet of access to all sides of the spa in the event your spas plumbing requires maintenance. Your spa warranty does not cover the cost of providing access for service.

SITE PREPARATION / GENERAL GUIDELINES

GENERAL CONSIDERATIONS FOR OUTDOOR INSTALLATION

Again, proper planning will increase your total enjoyment factor with your new spa. Listed below are some additional items to consider when planning your installation.

- How spa will complement landscaping and vice versa
- View from inside spa and view of spa from inside of home
- Exposure to sunlight and shading from trees
- Privacy
- Getting to spa from house and return
- Proximity to dressing rooms and bathrooms
- Storage for spa chemicals
- Local building codes (if applicable)
- Power cable

GENERAL CONSIDERATIONS FOR INDOOR INSTALLATION

Installing your spa indoors creates an entirely different set of considerations. Here again, with proper planning, no matter what room your spa goes in, it will be your favorite room.

- Work with your Master Spas dealer and contractor to insure all local building, electrical and plumbing codes are met
- Plan for a floor drain to drain off excess water or for draining and cleaning your spa
- A ventilation fan may be necessary due to high humidity created by your spa
- Finished material in your spa room should also be capable of withstanding increased humidity

INSTALLATION INSTRUCTIONS

1.) Put spa in final position that allows for access to equipment and spa components.



2.) Remove front side panel (this is the side where the main topside control panel is located) so the electrical service can be hooked up to the spa system pack. The panels can be taken off by first removing the three black thumb screws located on each corner. On the center panel there are four #2 Phillips screws that are covered with a colored snap cap. Remove the caps to access the screws for removal.

3.) Fill spa at least 1" above the filters. We recommend filling the spa through the filter area.

4.) Turn the power on to the spa. Spa will go through its priming mode. This lasts approximately 5 minutes.

5.) It may be necessary to bleed air from the pump(s) on your spa if, after start up, your spa pumps do not operate.

Due to the nature of water flow and hydro-therapy pumps, please be advised that air locking of pumps may occur. Master Spas has taken measures to reduce the possibility of this, but it still may occur, especially after refilling a spa. This is not a service covered under warranty.

To relieve an airlock situation, loosen the union (see picture) on the discharge of the pump (see arrow on picture of pump below). Water should leak out. Tighten the union and test the pump for proper jet flow. If needed repeat process.

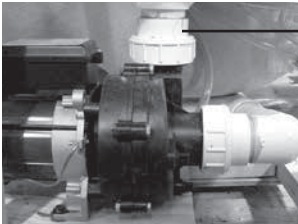

Pump Union

Airlock

6.) Adjust water chemistry according to the instructions provided in the "Water Quality Maintenance Section".

7.) Your spa water will heat approximately 4° – 7° per hour for the 240 volt spas. The heat due to the large body of water contained will heat approximately 1° – 2° per hour. Heating times may vary depending on the spas size and whether the cover is installed.

RELAX AND ENJOY.

WATER CHEMISTRY TERMS YOU SHOULD KNOW

Before jumping into the Spa Water Maintenance, here are some terms to help you.

- 1. Parts per million, or ppm:** This is a form of measurement used in most pool or spa chemical readings. Best described as any one million like items of equal size and make up, next to one unlike item, but of equal size. This would be one part per million.
- 2. Average size spa:** What is it? The national spa and pool institute (NSPI) states; 350 to 400 U.S. gallons is average. As a general rule, chemical dosages are the same for any spa between 100 and 500 U.S. gallons. Spas over 500 U.S. gallons the dosage would be double. Under 100 U.S. gallons would be on a case by case basis.
- 3. Total Alkalinity:** This is a measurement of the ability of the water to resist changes in pH. Put another way, it is the water's ability to maintain proper pH. Total alkalinity is measured in parts per million from 0 to 400 plus, with 80 to 150 ppm being the best range for spas. With low alkalinity, the pH will flip, or change back and forth, and be hard to control. With high alkalinity it becomes extremely difficult to change the pH.
- 4. pH or potential hydrogen:** This is a measurement of the active acidity in the water, or it is the measurement of the concentration of active hydrogen ions in the water. The greater the concentration of active hydrogen ions, the lower the pH. pH is not measured in parts per million, but on a scale from 0 to 14, with 7 being the neutral. In spas when ever possible, a measurement between 7.2 and 7.8 is best. Whenever possible, it should be between 7.4 and 7.6. With low pH, the results can be corroded metals, etched and stained plaster, stained fiberglass or acrylic, eye / skin irritation, rapid chlorine or bromine loss, and total alkalinity destruction. With high pH, the results can be cloudy water, eye / skin irritation, scale formation and poor chlorine or bromine efficiency.
- 5. Shocking:** This is when you add either extra chlorine (superchlorinate) by raising the chlorine level above 8 ppm, or add a non-chlorine shock (potassium monoperoxysulfate or potassium monopersulfate) to burn off the chloramines or bromamines. A non-chlorine shock acts by releasing oxygen in the water, which serves the same function as chlorine. The advantage to using non-chlorine shock, is you can enter the water within 15 minutes after shocking. Using chlorine, you must wait until the total chlorine reading is below 5 ppm. One thing to remember, a non-chlorine shock will not kill bacteria or disinfect.
- 6. Sequestering:** This can be defined as the ability to form a chemical complex which remains in solution, despite the presence of a precipitating agent (i.e. calcium and metals). Common names for sequestering chemicals are; minquest, stain and scale control, metal-x, spa defender, spa metal gone, (etc.).

WATER CHEMISTRY TERMS YOU SHOULD KNOW

Before jumping into the Spa Water Maintenance, here are some terms to help you.

- 7. Filtration:** Filters are necessary to remove particles of dust, dirt, algae, etc. that are continuously entering the water. If the spa is not operated long enough each day for the filter to do a proper job, this puts a burden on the chemicals, causing extra expense. Filtration time will depend on the spa size, pump and filter size, and of course, bather load. A spare cartridge should be kept on hand to make it easy to frequently clean the cartridge without the need for a long shut down. This will also allow the cartridge to dry out between usages, which will increase the cartridge life span as much as twice. Replace the cartridge when the pleats begin to deteriorate. Cartridge cleaning should be done a minimum of once a month. More often with a heavy bather load.
- 8. Sanitizers:** This is what kills the germs and bacteria that enter the water from the environment and the human body.
- A. Chlorine
 - 1. Only one type is approved for spa use
 - a. Sodium dichlor which is granular, fast dissolving and pH neutral chlorine.
 - 2. Chlorine is an immediate sanitizer.
 - B. Bromine
 - 1. Two types of tablets.
 - a. Hydrotech
 - b. Lonza
 - 2. Bromine is a slow dissolve chemical and may take a few days to develop a reserve or reading in the water.
- 9. Total dissolved solids (TDS):** Materials that have been dissolved by the water. i.e. Like what happens when you put sugar in coffee or tea.
- 10. Useful life of water (in days):** Water should be drained at least once every 180 days. Useful life may vary by usage and bather load.
- 11. Defoamer:** Foaming may be caused by body oils, cosmetics, lotions, surface cleaners, high pH or algeacides as well as other organic materials. Low levels of calcium or sanitizer can also cause foaming. Also, double rinse your bathing suits as they will hold residual soap after being washed.
12. Calcium hardness: Water that is too hard (over 250 ppm) can promote scale formation in components and on spa surface. Water that is too low (below 180 ppm) may also shorten the life of metal components on the spa.

NOTE: Always leave the spa cover open for 15 min. after adding chemicals to prevent off gas from damaging your spa cover, spa pillows, and other critical parts.

THE ADVANTAGES OF ECO PUR™ FILTRATION



Eco Pur™ water filter system is designed to reduce the use of chemicals in your spa. You will still be required, periodically, based on usage to add a small amount of chlorine to oxidize organic compounds in the water. The Eco Pur™ filter system will not eliminate the need to maintain proper water chemistry but can make the maintenance a more natural experience.

FEATURES

- The Eco Pur™ filter system will not oxidize organic compounds and will require periodic doses of chlorine to assist in the sanitization and oxidation processes required to maintain clear spa water.
- Eco Pur™ filter system will not alter the pH of spa water. The Eco Pur™ filter system will actually aid in stabilizing the pH. Eco Pur™ does not alter the (TDS) total dissolved solids.
- The main function of the Eco Pur™ filter system is to provide clean and clear spa water. Proper chemical balance and filtration are also key components in maintaining healthy spa water. Always ensure that the pH and total alkalinity of the spa water is checked and balanced at all times. To ensure proper filtration, clean the regular filter cartridge with a "filter cleaner" every 30 days and rinse the Eco Pur™ cartridge with a hose to remove any buildup of contaminants. (Do not soak the Eco Pur™ cartridge in filter cleaner.) If water appears to be visually cloudy, dull, or has an odor, shock the spa water with 1 ounce of chlorine* to remove excessive contaminants. When cleaning filters, be sure to never have the pumps (including the circulation pump) running without the filters in place. Failure to do so may result in debris being drawn into the pumps causing unwarranted damage.
- Helps remove calcium carbonate and hydrogen sulphide from spa water to protect heaters and equipment from precipitation.
- Helps stabilize the pH and alkalinity of the spa water.
- Helps reduce chemical usage and still provide safe odor-free water.
- Helps deplete excess chlorine after chemical shock to prevent damage to skin, hair, and swim wear.
- Helps to produce ultra clean and clear water.

Note: Eco Pur™ filters are not recommended for use with Bromine. Consult your dealer for additional information.

Master Spas, Inc. products are not designed to be used with Biquanides. These chemicals are found in SoftSwim® and Baqua Spa® products. Due to adverse effects from these types of sanitizers, the use of these products may void the spa warranty.

WATER QUALITY MAINTENANCE START-UP

For Eco Pur™ Water Filter System

- Step 1:** Your spa should be filled using a Pre-filter, which can be obtained from your local dealer. This Pre-filter will help remove many of the minerals existing in the water, which will make adjusting the water balance easier after a new fill. Never use more than 50% softened water when filling the spa.
- Step 2:** During the initial filling of the spa, add a sequestering agent to combat suspended minerals in the water. The agents are sold under many different names such as Mineral Clear, Stain and Scale, Metal Protect, and other brands. Allow water to circulate and filter for at least 12 hours before adding any other chemicals.
- Step 3:** Test water for pH, total Alkalinity, and Calcium hardness. The pH should be 7.2 - 7.8 and the total Alkalinity 80-150 PPM. Calcium hardness levels should be maintained between 150 and 250 PPM (part per million).
- Step 4:** Adjust pH and total Alkalinity (TA) utilizing the directions on the chemical bottles. Wait 15 minutes, test and adjust if necessary.
- Step 5:** It may be necessary to retest and add additional chemicals to get to the proper levels in Step 3.
- Step 6:** Add 2 ounces of concentrated chlorinating granules* (sodium Dichlor-s-triazinetrione) on initial start up to begin sanitizing the spa water. Always refer to the chemical manufacturer's dosage recommendations listed on the container. It is important not to add the chlorinating granules until the pH, alkalinity and calcium hardness have been adjusted to their proper levels.

*SPECIAL NOTE:

We recommend a minimum level of 1.0 ppm residual chlorine be maintained in spa water. Always refer to the chemical manufacturer's dosage recommendations listed on the container.

When adding chlorine or non-chlorine shock/oxidizer always broadcast across the water while the pumps are running.

The quantities of sanitizer and oxidizer shown in this manual are for 500 gallon spas and may have to be adjusted depending on the actual amount of water that your spa holds. See the specifications section of this manual for the correct gallons of your spa.

The concentration of active ingredients in spa chemicals varies by manufacturer. The amounts of sanitizer suggested in this manual are based on spa chemicals that have the active ingredient percentages listed below:

Chlorine	Non-Chlorine Shock/ Oxidizer
Active ingredient:	Active ingredient:
Sodium dichlor 99%	Potassium peroxymonosulfate 42.8%
Other ingredients..... 1%	Inert ingredients 57.2%
Total..... 100%	Total..... 100%

WATER QUALITY MAINTENANCE SCHEDULE - ECO PUR™

BEFORE EACH USE

Check spa water with a test strip for proper sanitation levels and adjust accordingly to the proper levels. Free chlorine level should be 1-3 ppm.

ONCE A WEEK

Add 1 ounce of non-chlorine shock/oxidizer* or chlorine* to spa to help maintain the water quality.

3 TIMES A WEEK

Test water using chemical test strips. Adjust sanitizer, pH and Alkalinity accordingly. The total alkalinity should be between 80 - 150 ppm and the PH should be between 7.2 - 7.8.

ONCE A MONTH

Soak your regular filter elements overnight in a container with spa Filter Cleaner and then rinse with clean water. For best results, allow the filter to dry before re-inserting. (The Eco Pur™ mineral element should never be cleaned in a filter cleaner. Just rinse with water.) When cleaning filters, be sure to never have the pumps (including the circulation pump) running without the filters in place. Failure to do so may result in debris being drawn into the pumps causing unwarranted damage. See the "clean your filter elements" in the maintenance section of this manual for more information.

EVERY 180 DAYS

Drain and refill your spa with fresh water, install a new Eco Pur™ filter element, clean the regular filter, and repeat start up procedure. The regular filter should be replaced at least once every year.

AFTER EACH USE

Add 1 ounce of non-chlorine shock/oxidizer* or 1/2 ounce of chlorine* to the spa water.

*SPECIAL NOTE:

We recommend a minimum level of 1.0 ppm residual chlorine be maintained in spa water. Always refer to the chemical manufacturer's dosage recommendations listed on the container.

When adding chlorine or non-chlorine shock/oxidizer always broadcast across the water while the pumps are running.

The quantities of sanitizer and non-chlorine oxidizer shown in this manual are for 500 gallon spas and may have to be adjusted depending on the actual amount of water that your spa holds. See the specifications section of this manual for the correct gallons of your spa.

The concentration of active ingredients in spa chemicals varies by manufacturer. The amounts of sanitizer suggested in this manual are based on spa chemicals that have the active ingredient percentages listed below:

Chlorine	Non-Chlorine Shock/ Oxidizer
Active ingredient:	Active ingredient:
Sodium dichlor 99%	Potassium peroxymonosulfate 42.8%
Other ingredients..... 1%	Inert ingredients..... 57.2%
Total..... 100%	Total..... 100%

WATER QUALITY MAINTENANCE SCHEDULE - ECO PUR™ (CONTINUED)

AS NEEDED

If water looks hazy, check PH and Total Alkalinity, and treat with 1 ounce of chlorine*. Always refer to the chemical manufactures dosage recommendations listed on the container.

These are general recommendations for water quality maintenance that may vary by usage and or bather load. Depending on bather load and frequency of use, drain and refill times may vary as well as the frequency of cleaning your filters.

A defoamer may be used when excessive foaming occurs. Over use of a defoamer will result in cloudy, milky water.

USE ONLY SPA CHEMICALS

Do not use chemicals designed for use in swimming pools.

With a spa you are working with a small volume of hot water compared to a large volume of relatively cool water in a swimming pool. Because of this chemicals will have a shorted life span and bacteria can grow more quickly than in a swimming pool. A spa is less forgiving then a pool and requires that whatever is put into it have a pH as close to neutral as possible. That is why only chemicals made for spas should be used. Always refer to the chemical manufactures dosage recommendations listed on the container.

*SPECIAL NOTE:

We recommend a minimum level of 1.0 ppm residual chlorine be maintained in spa water. Always refer to the chemical manufacturer's dosage recommendations listed on the container.

When adding chlorine or non-chlorine shock/oxidizer always broadcast across the water while the pumps are running.

The quantities of sanitizer and oxidizer shown in this manual are for 500 gallon spas and may have to be adjusted depending on the actual amount of water that your spa holds. See the specifications section of this manual for the correct gallons of your spa.

The concentration of active ingredients in spa chemicals varies by manufacturer. The amounts of sanitizer suggested in this manual are based on spa chemicals that have the active ingredient percentages listed below:

Chlorine	Non-Chlorine Shock/ Oxidizer
Active ingredient:	Active ingredient:
Sodium dichlor 99%	Potassium peroxymonosulfate 42.8%
Other ingredients..... 1%	Inert ingredients 57.2%
Total 100%	Total..... 100%

SPA WATER MAINTENANCE TROUBLE-SHOOTING GUIDE

PROBLEM	POSSIBLE CAUSES	HOW TO FIX IT
Chlorine / Bromine Odor	• Excessive Chlorine or bromine levels	• Shock water with non-chlorine shock treatment
	• Low pH	• Adjust pH if necessary
Water Odor	• Low levels of sanitizer	• Shock water with non-chlorine shock treatment or adjust sanitizer levels
	• pH out of range	• Adjust pH level if necessary
	• Bacteria or algae growth	• Adjust sanitizer if necessary
Cloudy Water	• Dirty filters or inadequate filtration	• Clean filters and adjust filtration times
	• Water chemistry not balanced	• Adjust chemistry levels
	• Suspended particles or organic materials	• Add spa clarifier (see dealer)
	• Old water	• Change spa water
Scum Ring Around Spa	• Build up of oils, dirt and organic elements	• Wipe off with a clean towel add an enzyme product.
Eye / Skin Irritation	• Unsanitary water	• Shock spa with non-chlorine shock
	• Free chlorine level above 5 ppm	• Allow level to drop below 5 ppm
	• Poor sanitizer / pH levels	• Adjust according to spa test strip results
Foaming	• High levels of body oils, lotions, soap, etc.	• Add small amount of defoamer

RECOMMENDED LEVELS OF CHEMICAL

Chlorine 1.0 - 3.0 ppm

pH 7.2 - 7.8

Total Alkalinity 80 - 150 ppm

Calcium Hardness 180 - 250 ppm

WHY CHEMICALS ARE IMPORTANT IN A SPA

- 1. Evaporation:** As water evaporates, only pure water evaporates, leaving the salts, minerals, metals, and any unused chemicals behind. Adding water adds more salts, minerals, and metals. In time, the water can become saturated with these dissolved solids and can cause stains or scale to form on the walls of the spa or a scale build up inside the equipment. Colored or cloudy water, and possible corrosion of plumbing and fittings may also occur.
- 2. Heat:** Heat causes much quicker evaporation and also will cause minerals and metals to precipitate out of solution.
- 3. Air:** Dust and airborne dirt particles are introduced into the spa.
- 4. Environment:** The environment surrounding the spa can also impact the water quality. Items such as pollen, grass, sand, dirt, lawn fertilizer, airborne dust, insects, leaves, and pets can all affect the water quality of the spa.

REMEMBER:

The maintenance routines set forth in this manual may need to be adjusted depending on how much the spa is being used.

MAINTENANCE RECOMMENDATIONS

Your spa requires periodic draining and cleaning to ensure a safe, healthy environment. It is recommended that you clean your spa at least every 180 days. Heavy bather load will require cleaning it more often.

DRAIN YOUR SPA

- See pages 11 & 68.

CLEAN YOUR SPA SURFACE

- With a soft cloth, wipe down the spa surface with a non-abrasive spa surface cleaner that may be purchased through your local spa dealer. Do not use paper towels. Be sure to rinse residue from spa surface.
- If your spa has developed an oily or chalky residue at the waterline it may require special treatment. Consult your dealer.

REFILL YOUR SPA

- Be sure to close the drain valve.
- Fill the swim spa with water and be sure that water level is above the skimmer opening at the minimum safe water level sticker.
- Refer to the start-up section for specific instructions.

CLEAN YOUR FILTER ELEMENT (also reference page 69)

- The filter elements are one of the most important components of your spa. Not only are they essential for clean water, but they also extend the life of the spa equipment. Your filter elements should be cleaned on a regular basis, once a month on average with normal usage. With heavy use the filters may need to be cleaned more often.
- Turn off the swim spa before servicing filters. Never leave to the swim spa running when removing the filters. Debris can be pulled into the plumbing system and cause unwarranted damage.
- Remove filter element.
- With a garden hose, spray the element under pressure. Periodically, the element needs to be soaked in a filter cleaner compound. Do not soak Eco Pur filters in cleaner compounds. Check with your dealer for details on cleaning and/or filter replacement recommendations.
- Replace filter element. Care must be taken NOT to over tighten the threaded filter element. The filter needs to be lightly snugged and no more.
- Be sure water level is adequate.
- Turn spa on.

CARE OF YOUR SPA PILLOWS

- Your spa pillows need to be rinsed periodically to remove any chemical residue. This should help to eliminate pillows becoming stiff and discolored.
- If the swim spa will not be used for a period of time, the pillows should be removed to extend their useful life.

MAINTENANCE RECOMMENDATIONS

STAINLESS STEEL

Master Spas uses stainless steel in a number of our spas. Its lasting beauty and resistance to corrosion make it an excellent material for handrails and jets faces.

With the proper care it will keep its luster for many years. All stainless steel can corrode given the right circumstances so we have provided a guide to help you keep the stainless components in your spa looking nice.

Stainless steel derives its ability to resist corrosion by forming a very thin transparent coating on the surface when exposed to oxygen. This coating can be damaged by abrasive materials such as steel wool, sand paper, and other cleaning materials that are abrasive. Chlorine salts, sulfides, or other rusting metals can also erode this thin coating exposing the metal to corrosion.

The best defense to combat corrosion on stainless steel components in your spa is make sure that it is kept clean and free of any chemical build up.

Always:

- Clean frequently with clear clean water.
- Remove any rust spots as soon as they appear with vinegar or a brass, silver, or chrome cleaner.
- Use a good car cleaning wax for extra protection.

Never:

- Clean with mineral acids or bleaches.
- Clean with steel wool or any other abrasive material.
- Leave in contact with iron, steel any other metals.

NOTE: Failure to take proper care of the stainless steel fixture could result with them rusting. Rusting is not covered by the warranty.

NOTE: Do not cover the spa for 15 minutes after adding chemicals as the off gas can cause unwarranted damage.

WINTERIZING YOUR SPA

Many people find they enjoy using their spa more in the winter than any other time. Your spa is designed to be used year round in any type of climate.

*However, if you decide you don't want to use your spa in the winter, you must drain it and follow the winterizing steps listed below:

- 1.) Drain your spa completely using the drain valve (see "To Drain Your Spa") or use an inexpensive submersible pump that you can buy from your dealer or your local hardware store.
- 2.) Use a shop vac to get all standing water out of your unit.
- 3.) Remove access panels from equipment area.
- 4.) Loosen all pump unions
- 5.) Remove winterizing plug from face of the pump(s) where applicable.
- 6.) Using your shop vac in a blowing mode, insert the hose into the nozzle of each jet and blow the trapped water from the lines into the interior of the spa.
- 7.) After this is completed, use the shop vac to remove any standing water in the spa and in the equipment area.
- 8.) Clean the spa with a soft cloth and a non-abrasive spa surface cleaner.
- 9.) Replace access panels.
- 10.) Cover spa to prevent water from entering the spa.

*** Disclaimer: Master Spas does not recommend winterizing your spa. If you choose to do so, any damage that may result is not covered under the spa warranty.**

TWILIGHT SPA - SPECIFICATIONS

	Spa Dimensions	Electrical Requirements	Water Capacity (gallons)	Weight Dry/Full (lbs.)	Therapy Pumps	Jet Count
TS 6.1	78 x 78 x 34	240V, 50 Amp	320	580 / 3,245	1	21
TS 6.2	78 x 78 x 34	240V, 50 Amp	320	630 / 3,295	2	30
TS 67.15	70 x 84 x 34	240V, 50 Amp	320	530 / 3,090	1	20
TS 67.25	70 x 84 x 34	240V, 50 Amp	320	530 / 3,140	2	28
TS 7.1	84 x 84 x 38	240V, 50 Amp	420	705 / 3,995	1	28
TS 7.15	84 x 84 x 38	240V, 50 Amp	435	685 / 4,296	1	30
TS 7.2	84 x 84 x 38	240V, 50 Amp	420	755 / 4,045	2	36
TS 7.25	84 x 84 x 38	240V, 50 Amp	435	785 / 4,396	2	36
TS 8.2	94 x 94 x 38	240V, 50 Amp	485	755 / 4,680	2	44
TS 8.25	94 x 94 x 38	240V, 50 Amp	510	755 / 4,988	2	47
TS 8.3	94 x 94 x 38	240V, 50 Amp	485	805 / 4,730	3	50
TS 8.35	94 x 94 x 38	240V, 50 Amp	510	805 / 5,038	3	53
TS 120	78 x 78 x 34	120V, 50 Amp	210	465 / 2,205	1	18
TS 240	78 x 78 x 34	240V, 50 Amp	210	515 / 2,258	1	26
TS Fit	94 x 132 x 60	240V, 50 Amp	1,100	1,825 / 10,955	2	58

Note: For spas equipped with an optional 24 hr circulation pump add 1 additional pump to the count.

MAIN MENU: TS 6.1, TS 67.15, TS 7.1, TS 7.15



NAVIGATION

Navigating the entire menu structure is done with 2 or 3 buttons on the control panel.

Some panels have separate **WARM** (Up) and **COOL** (Down) buttons, while others have a single Temperature button. In the navigation diagrams Temperature buttons are indicated by a single button icon.

Panels that have two **Temperature** buttons (Warm and Cool) can use both of them to simplify navigation and programming where a single Temperature icon is shown.

The **LIGHT** Button is also used to choose the various menus and navigate each section.



Typical use of the Temperature button(s) allows changing the Set Temperature while the numbers are flashing in the LCD. Pressing the **LIGHT** button while the numbers are flashing will enter the menu.

The menus can be exited with certain button presses. Simply waiting for several seconds will return the panel operation to normal.

Power-up Screens

Each time the System powers up, a series of numbers is displayed. After the startup sequence of numbers, the system will enter Priming Mode (See Page 31).

Key

-  Indicates Flashing or Changing Segment
-  Indicates Alternating or Progressive Message - every 1/2 second
- A temperature button, used for "Action"

Waiting time that keeps the last change to a menu item.

- ***** Waiting time (depends on menu item) that reverts to original setting and ignores any change to that menu item.

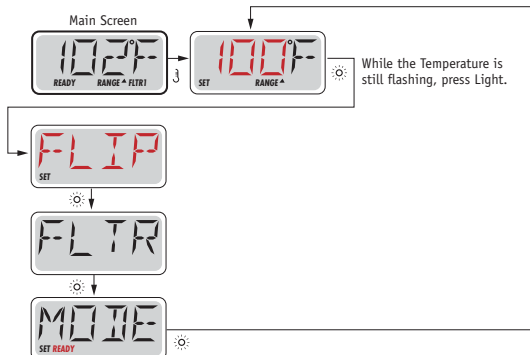

Waiting Several Seconds in the Main Menu will allow the display to revert to the Main Screen. Most changes are not saved unless Light  is pressed. Refer to Key above.

FILL IT UP!

TS 6.1, TS 67.15, TS 7.1, TS 7.15

PREPARATION AND FILLING

Fill the spa to its correct operating level. Be sure to open all valves and jets in the plumbing system before filling to allow as much air as possible to escape from the plumbing and the control system during the filling process.

After turning the power on at the main power panel, the top-side panel display will go through specific sequences. These sequences are normal and display a variety of information regarding the configuration of the hot tub control.

PRIMING MODE

This mode will last for 4-5 minutes or you can manually exit the priming mode after the pump(s) have primed.



Regardless of whether the priming mode ends automatically or you manually exit the priming mode, the system will automatically return to normal heating and filtering at the end of the priming mode. During the priming mode, the heater is disabled to allow the priming process to be completed without the possibility of energizing the heater under low-flow or no-flow conditions. Nothing comes on automatically, but the pump(s) can be energized by pushing the "Jet" buttons. If the spa has a 24 hour Circ Pump, it can be activated by pressing the "Light" button during Priming Mode.

PRIMING THE PUMPS

As soon as the above display appears on the panel, push the "Jet" button once to start Pump 1 in low-speed and then again to switch to high-speed. Also, push the Pump 2 or "Aux" button, if you have a 2nd pump, to turn it on. The pumps will now be running in high-speed to facilitate priming. If the pumps have not primed after 2 minutes, and water is not flowing from the jets in the spa, do not allow the pumps to continue to run. Turn off the pumps and repeat the process. Note: Turning the power off and back on again will initiate a new pump priming session. Sometimes momentarily turning the pump off and on will help it to prime. Do not do this more than 5 times. If the pump(s) will not prime, shut off the power to the spa and follow the instructions shown for removing air locks in the installation instructions section of this manual.

Important: A pump should not be allowed to run without priming for more than 2 minutes. Under NO circumstances should a pump be allowed to run without priming beyond the end of the 4-5 minute priming mode. Doing so may cause damage to the pump and cause the system to energize the heater and go into an overheat condition.

EXITING PRIMING MODE

You can manually exit Priming Mode by pressing a "Temp" button (Up or Down). Note that if you do not manually exit the priming mode as described above, the priming mode will be automatically terminated after 4-5 minutes. Be sure that the pump(s) have been primed by this time.

Once the system has exited Priming Mode, the top-side panel will momentarily display the set temperature but the display will not show the temperature yet, as shown below. This is because the system requires approximately 1 minute of water flowing through the heater to determine the water temperature and display it.



SPA BEHAVIOR

TS 6.1, TS 67.15, TS 7.1, TS 7.15

PUMPS

Press the "Jets 1" button once to turn pump 1 on or off, and to shift between low- and high-speeds if equipped. If left running, the pump will turn off after a time-out period. The pump 1 low-speed will time out after 30 minutes. The high-speed will time out after 15 minutes.

If the spa is in Ready Mode (See page 34), Pump 1 low may also activate for at least 1 minute every 30 minutes to detect the spa temperature (polling) and then to heat to the set temperature if needed. When the low-speed turns on automatically, it cannot be deactivated from the panel, however the high speed may be started.

Circulation Pump

The 24 hour circ pump operates continuously with the exception of turning off for 30 minutes at a time when the water temperature reaches 3°F (1.5°C) above the set temperature (most likely to happen in very hot climates).

FILTRATION AND OZONE

On non-circ systems, Pump 1 low and the ozone generator will run during filtration. On 24 hour circ systems, the ozone will run with the 24 hour circ pump.

The system is factory-programmed with two filter cycles that will run 10 minutes after power-up. The filter duration is programmable. (See page 35)

At the start of each filter cycle, Pump 2 (if there is one) will run briefly to purge its plumbing to maintain good water quality.

FREEZE PROTECTION

If the temperature sensors within the heater detect a low enough temperature, then the pump(s) automatically activate to provide freeze protection. The pump(s) will run either continuously or periodically depending on conditions. If the temperature sensors detect a drop to below 44°F/6.7°C within the heater, the pump will automatically activate to provide freeze protection. The equipment stays on until 4 minutes after the sensors detect that the spa temperature has risen to 45°F/7.2°C or higher. During freeze protection the heater will not be activated.

If the temperature sensors detect a drop to below 44°F/6.7°C within the heater, the pump will automatically activate to provide freeze protection. The equipment stays on until 4 minutes after the sensors detect that the spa temperature has risen to 45°F/7.2°C or higher. During freeze protection the heater will not be activated.

TEMPERATURE AND TEMP RANGE

TS 6.1, TS 67.15, TS 7.1, TS 7.15

ADJUSTING THE SET TEMPERATURE

When using a panel with Up and Down buttons (Temperature buttons), pressing Up or Down will cause the temperature to flash. Pressing a temperature button again will adjust the set temperature in the direction indicated on the button. When the LCD stops flashing, the spa will heat to the new set temperature when required.

If the panel has a single temperature button, pressing the button will cause the temperature to flash. Pressing the button again will cause the temperature to change in one direction (e.g. UP). After allowing the display to stop flashing, pressing the Temperature Button will cause the temperature to flash and the next press will change the temperature in the opposite direction (e.g. DOWN).

The temperature can be set between 80°F and 104°F.

PRESS-AND-HOLD

If a Temperature button is pressed and held when the temperature is flashing, the temperature will continue to change until the button is released. If only one temperature button is available and the limit of the Temperature Range is reached when the button is being held, the progression will reverse direction.

MODE – READY AND REST

TS 6.1, TS 67.15, TS 7.1, TS 7.15

In order for the spa to heat, a pump needs to circulate water through the heater. The pump that performs this function is known as the “heater pump.”

The heater pump can be either a 2-Speed Pump 1 or a 24 hour circulation pump.

If the heater pump is a 2-Speed Pump 1, READY Mode will circulate water every 1/2 hour, using Pump 1 Low, in order to maintain a constant water temperature, heat as needed, and refresh the temperature display. This is known as “polling.”

REST Mode will only allow heating during programmed filter cycles. Since polling does not occur, the temperature display may not show a current temperature until the heater pump has been running for a minute or two.

24 Hour Circulation Mode (See Page 32, under Pumps, for other circulation modes)

If the spa is configured for 24HR circulation, the heater pump runs continuously. Since the heater pump is always running, the spa will maintain set temperature and heat as needed in Ready Mode, without polling.

In Rest Mode, the spa will only heat to set temperature during programmed filter times, even though the water is being filtered constantly when in Circulation Mode.

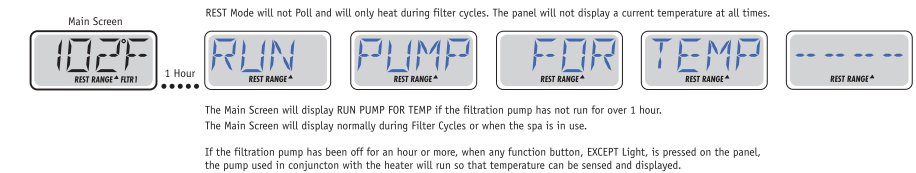
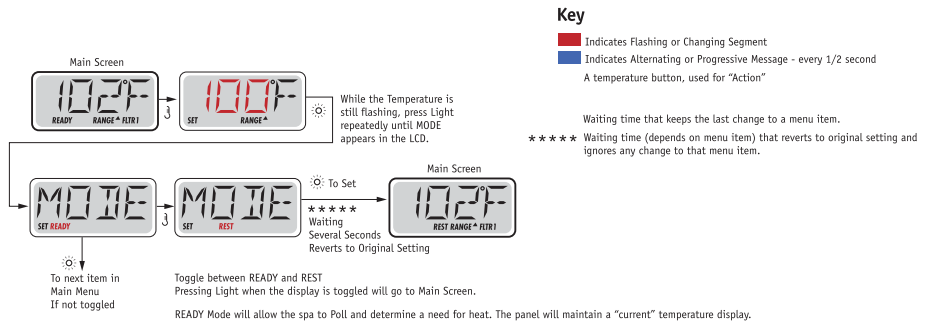

READY-IN-REST MODE

READY/REST appears in the display if the spa is in Rest Mode and Jet 1 is pressed. It is assumed that the spa is being used and will heat to set temperature. While Pump 1 High can be turned on and off, Pump 1 Low will run until set temperature is reached, or 1 hour has passed. After 1 hour, the System will revert to Rest Mode. This mode can also be reset by entering the Mode Menu and changing the Mode.

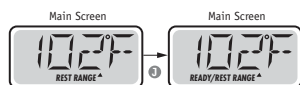

FLIP (INVERT DISPLAY)

TS 6.1, TS 67.15, TS 7.1, TS 7.15

- Indicates Flashing or Changing Segment
- Indicates Alternating or Progressive Message - every 1/2 second
- A temperature button, used for "Action"

Waiting time that keeps the last change to a menu item.

***** Waiting time (depends on menu item) that reverts to original setting and ignores any change to that menu item.

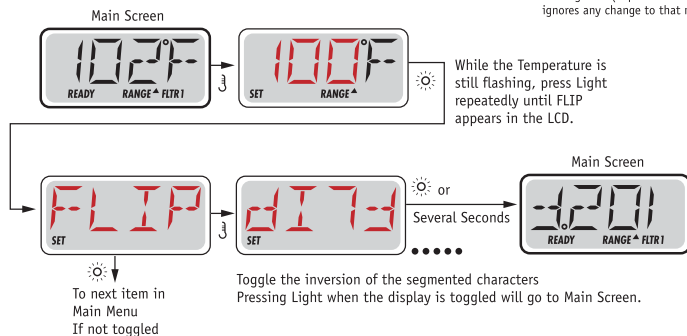

NOTE:

Some panels may have a dedicated FLIP button, which allows the user to flip the display with a single button-press.

ADJUSTING FILTRATION

MAIN FILTRATION

Filter cycles are set using a duration. Each setting can be adjusted in 1-hour increments. Filter Cycle 1 and Filter Cycle 2 (if enabled) are set to the same duration.

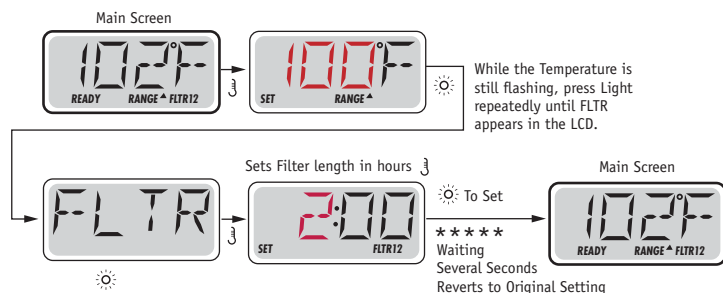

If Filter Cycle 2 is enabled, Filter 12 will appear in the LCD. If Filter is disabled, Filter 1 will appear.

PURGE CYCLES

In order to maintain sanitary conditions, secondary Pumps will purge water from their respective plumbing by running briefly at the beginning of each filter cycle.

GENERAL MESSAGES

TS 6.1, TS 67.15, TS 7.1, TS 7.15



PRIMING MODE

Each time the spa is powered up, it will enter Priming Mode. The purpose of Priming Mode is to allow the user to run each pump and manually verify that the pumps are primed (air is purged) and water is flowing. This typically requires observing the output of each pump separately, and is generally not possible in normal operation. Priming Mode lasts 4 minutes, but you can exit it earlier by pressing any Temp button. The heater is not allowed to run during Priming Mode.

NOTE: If your spa has a 24 hour Circ Pump, it will turn on with Jets 1 in Priming Mode. The 24 hour Circ Pump will run by itself when Priming Mode is exited.



WATER TEMPERATURE IS UNKNOWN

After the pump has been running for 1 minute, the temperature will be displayed.



TOO COLD - FREEZE PROTECTION

A potential freeze condition has been detected, and all pumps are activated. All pumps are ON for at least 4 minutes after the potential freeze condition has ended.

In some cases, pumps may turn on and off and the heater may operate during Freeze Protection.

This is an operational message, not an error indication.



WATER IS TOO HOT (OHS)

One of the water temp sensors has detected spa water temp 110°F (43.3°C) and spa functions are disabled. System will auto reset when the spa water temp is below 108°F (42.2°C). Check for extended pump operation or high ambient temp.

* This message can be reset from the topside panel with any button press.

HEATER-RELATED MESSAGES

TS 6.1, TS 67.15, TS 7.1, TS 7.15



HEATER FLOW IS REDUCED (HFL)

There may not be enough water flow through the heater to carry the heat away from the heating element. Heater start up will begin again after about 1 min. See "Flow Related Checks" below.



HEATER FLOW IS REDUCED (LF)*

There is not enough water flow through the heater to carry the heat away from the heating element and the heater has been disabled. See "Flow Related Checks" below. After the problem has been resolved, you must press any button to reset and begin heater start up.



HEATER MAY BE DRY (DR)*

Possible dry heater, or not enough water in the heater to start it. The spa is shut down for 15 min. Press any button to reset the heater start-up. See "Flow Related Checks" below.



HEATER IS DRY*

There is not enough water in the heater to start it. The spa is shut down. After the problem has been resolved, you must press any button to reset and restart heater start up. See "Flow Related Checks" below.



HEATER IS TOO HOT (OHH)*

One of the water temp sensors has detected 118°F (47.8°C) in the heater and the spa is shut down. You must press any button to reset when water is below 108°F (42.2°C). See "Flow Related Checks" below.



A RESET MESSAGE MAY APPEAR WITH OTHER MESSAGES.

Some errors may require power to be removed and restored.

FLOW-RELATED CHECKS

Check for low water level, suction flow restrictions, closed valves, trapped air, too many closed jets and pump prime.

On some systems even when spa is shut down, some equipment may occasionally turn on to continue monitoring temperature or if freeze protection is needed.

* This message can be reset from the topside panel with any button press.

SENSOR-RELATED MESSAGES

TS 6.1, TS 67.15, TS 7.1, TS 7.15



SENSOR BALANCE IS POOR

The temperature sensors MAY be out of sync by 2°F or 3°F. Call for Service.



SENSOR BALANCE IS POOR*

The temperature sensors are out of sync. The Sensor Balance is poor fault has been established for at least 1 hour. Call for Service.



SENSOR FAILURE – SENSOR A, SENSOR B

A temperature sensor or sensor circuit has failed. Call for Service.

MISCELLANEOUS MESSAGES



NO COMMUNICATIONS

The control panel is not receiving communication from the System. Call for Service.



°F OR °C IS REPLACED BY °T

The Control System is in Test Mode. Call for Service.

* This message can be reset from the topside panel with any button press.

SYSTEM-RELATED MESSAGES

TS 6.1, TS 67.15, TS 7.1, TS 7.15

MEM FAIL -----

MEMORY FAILURE - CHECKSUM ERROR*

At Power-Up, the system has failed the Program Checksum Test. This indicates a problem with the firmware (operation program) and requires a service call.

MEM RSET -----

MEMORY WARNING - PERSISTENT MEMORY RESET*

Appears after any system setup change. Contact your dealer or service organization if this message appears on more than one power-up, or if it appears after the system has been running normally for a period of time.

CLOCK FAIL -----

MEMORY FAILURE - CLOCK ERROR*

Contact your dealer or service organization.

CNFG FAIL -----

CONFIGURATION ERROR – SPA WILL NOT START UP

Contact your dealer or service organization.

STUCK PUMP -----

A PUMP APPEARS TO BE STUCK ON

Water may be overheated. POWER DOWN THE SPA. DO NOT ENTER THE WATER. Contact your dealer or service organization.

HOT FAULT ----- CALL FOR SRVC -----

A PUMP APPEARS TO HAVE BEEN STUCK ON WHEN SPA WAS LAST POWERED – M035

POWER DOWN THE SPA. DO NOT ENTER THE WATER. Contact your dealer or service organization.

* This message can be reset from the topside panel with any button press.

TWILIGHT SPA – CONTROLS

TS 6.2 • TS 67.25 • TS 7.2 • TS 7.25 • TS 8.2 TS 8.25 • TS 8.3 TS 8.35 • TS 240

INITIAL START-UP

When your spa is first actuated, it will go into Priming mode, indicated by "Pr" Be sure the pumps and heating system are free of air by cycling the pumps on and off with the spa-side panel buttons. The spa will not heat during priming mode, allowing time to verify all air is purged from the heater. The Priming mode will last for less than 5 minutes (press "Warm" or "Cool" to skip Priming Mode) and then the spa will begin to heat and maintain the water temperature in the Standard mode.

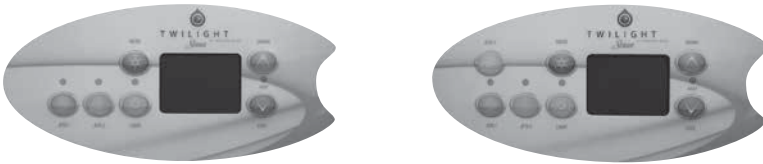

Warm/Cool (80°F - 104°F / 26°C - 40°C)

The start-up temperature is set at 100F/37°C. The last measured temperature is constantly displayed on the LCD.

Note that the last measured spa temperature displayed is current only when the low speed of pump 1 has been running for at least 2 minutes (temperature is always current on spas equipped with 24 hour circulation pump). To display the set temperature, press the "Warm" or "Cool" pad once. To change the set temperature, press the pad a second time before the LCD stops flashing. Each press of the "Warm" or "Cool" pad will continue to either raise or lower the set temperature. After three seconds, the LCD will stop flashing and display the current spa temperature.

Jets 1

Touch the "Jets" button once to turn pump 1 on or off, and to shift between low and high speeds. If left running, the low speed of the pump will automatically turn off after 4 hours, and the high speed will automatically turn off after 15 minutes.

Jets 2

Touch the second "Jets" button once to turn pump 2 on or off. If left running, pump 2 will automatically turn off after 15 minutes. This pump has one speed.

Jets 3 (If so equipped)

Touch the second "Jets" button once to turn pump 2 on or off. If left running, pump 3 will automatically turn off after 15 minutes This pump has one speed.

TWILIGHT SPA – CONTROLS

TS 6.2 • TS 67.25 • TS 7.2 • TS 7.25 • TS 8.2 TS 8.25 • TS 8.3 TS 8.35 • TS 240

L.E.D. Lights

Press the “Light” button to turn the light on and off. If you wish to change the “function” of the lights, turn the lights off, then on within 5 seconds.

Mode

Mode is changed by pressing the “Warm” or “Cool” button, then pressing the “Mode” button.

Standard Mode is programmed to maintain the desired temperature. Note that the last measured spa temperature displayed is current only when the pump has been running for at least 2 minutes. “*Std*” will be displayed momentarily when you switch into Standard Mode.

Economy Mode heats the spa to the set temperature only during filter cycles. “*Ecn*” will display solid when temperature is not current, and will alternate with temperature when temperature is current.

Sleep Mode heats the spa to within 20°F/10°C of the set temperature only during filter cycles. “*SLP*” will display solid when temperature is not current, and will alternate with temperature when temperature is current.

Preset Filter Cycles

The first filter cycle begins 6 minutes after the spa is energized. The second filter cycle begins 12 hours later. Filter duration is programmable for 2, 4, 6, 8 hours or for continuous filtration (indicated by “*FC*”). The default filter time is 2 hours. To program, press “Temp” then “Jets.” Press “Temp” to adjust. Press “Jets” to exit programming. At the beginning of each filter cycle the pump(s) purge for 30 seconds; the pump purges for 5 minutes. The only effect filter duration has is: 1) During the filter cycle, the low-speed of pump 1 never turns off, and 2) In Economy and Sleep Modes, heating only occurs during the filter cycle. On spas equipped with 24 hour circulation pumps the filter cycle is not needed and does not operate.

Freeze Protection

If the temperature sensors detect a drop to below 44°F/6.7°C within the heater, the pump will automatically activate to provide freeze protection. The equipment stays on until 4 minutes after the sensors detect that the spa temperature has risen to 45°F/7.2°C or higher. During freeze protection the heater will not be activated.

TWILIGHT SPA – DIAGNOSTIC MESSAGES

MESSAGE	MEANING	ACTION REQUIRED
	No message on display. Power has been cut off to the spa.	The control panel will be disabled until power returns. Spa settings will be preserved until next power up.
--	Temperature unknown.	After the pump has been running for 2 minutes, the temperature will be displayed.
HH	"Overheat" - The spa has shut down. One of the sensors has detected 118°F/48°C at the heater.	DO NOT ENTER THE WATER. Remove the spa cover and allow water to cool. Once the heater has cooled, reset by pushing any button. If spa does not reset, shut off the power to the spa and call your dealer or service organization.
OH	"Overheat" - The spa has shut down. One of the sensors has detected that the spa water is 110°F/43°C.	DO NOT ENTER THE WATER. Remove the spa cover and allow water to cool. At 107°F/42°C, the spa should automatically reset. If spa does not reset, shut off the power to the spa and call your dealer or service organization.
IC	"Ice" - Potential freeze condition detected.	No action required. The pump(s) will automatically activate regardless of spa status.
SA	Spa is shut down. The sensor that is plugged into the Sensor "A" jack is not working.	If the problem persists, contact your dealer or service organization. (May appear temporarily in an overheat situation and disappear when the heater cools.)
Sb	Spa is shut down. The sensor that is plugged into the Sensor "B" jack is not working.	If the problem persists, contact your dealer or service organization. (May appear temporarily in an overheat situation and disappear when the heater cools.)
Sn	Sensors are out of balance. If alternating with spa temperature, it may just be a temporary condition. If flashing by itself, spa is shut down.	If the problem persists, contact your dealer or service organization.
HL	A significant difference between temperature sensors has been detected. This could indicate a flow problem.	Check water level in spa. Refill if necessary. If the water level is okay, make sure the pumps have been primed. If problem persists, contact your dealer or service organization.
LF	Persistent low flow problems. (Displays on the fifth occurrence of "HL" message within 24 hours.) Heater is shut down, but other spa functions continue to run normally.	Follow action required for "HL" message. Heating capability of the spa will not reset automatically; you may press any button to reset. Check filters for possible blockage.
dr	Possible inadequate water, poor flow, or air bubbles in detected in the heater. Spa is shut down for 15 minutes.	Check water level in spa. Refill if necessary. If water level is okay, make sure the pump(s) have been primed. Press any button to reset, or this message will automatically reset within 15 minutes. If problem persists, contact your dealer or service organization.
dy	Inadequate water detected in heater. (Displays on third occurrence of "dr" message.) Spa is shut down.	Follow action required for "dr" message. Spa will not automatically reset. Press any button to reset.

Warning! Shock Hazard! No User Serviceable Parts. Do not attempt service of this control system. Contact your dealer or service organization for assistance. Follow all owner's manual power connection instructions. Installation must be performed by a licensed electrician and all grounding connections must be properly installed.

THE MAIN SCREEN - TS FIT



SPA STATUS

Important information about spa operation can be seen quickly from the Main Screen.

The most important features, including Set Temperature adjustment, can be accessed from this screen.

The actual water temperature can be seen in large text and the desired, or Set Temperature, can be selected and adjusted.

Time-of-day, Ozone operation and Filter Operation status is available, along with other messages and alerts.

High Temperature Range vs. Low Temperature Range is indicated in the upper right corner.

The Jets Icon in the center will indicate when a pump is running and also the heater function.

A Lock icon is visible if the panel or settings are locked.

The Menu choices on the right can be selected and the screen will change to show more detailed controls or programming functions.

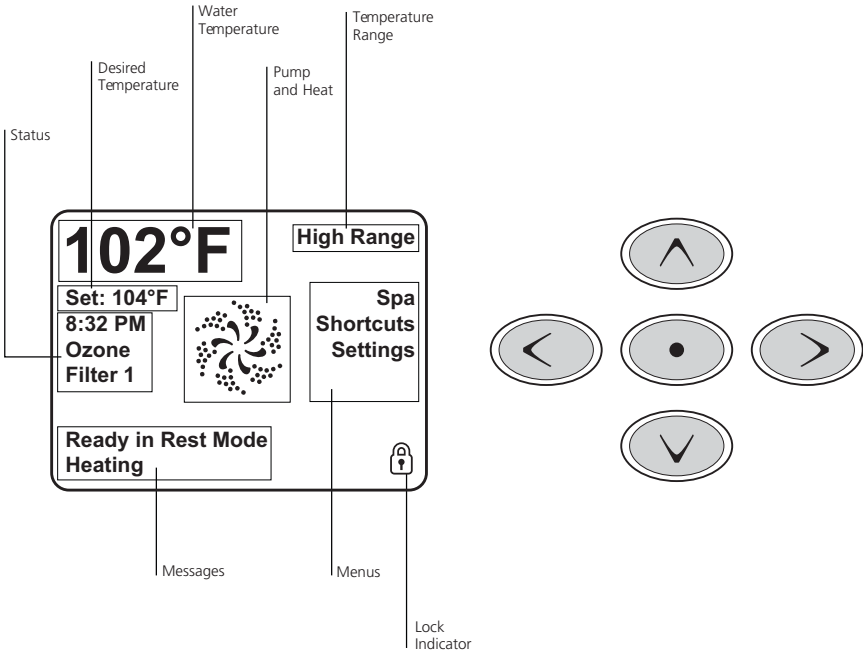

THE MAIN SCREEN - TS FIT

NAVIGATION

Navigating the entire menu structure is done with the 5 buttons on the control panel.

When a text item changes to white during navigation, that indicates the item is selected for action.

Operating or changing a selected item is generally done with the center or "Select" button.

The only item that can be changed on the left side of the Main Screen is the Set Temperature. Press the Left Arrow button to change the Set Temperature number to white. The Set Temperature can then be adjusted with the up and down buttons. Pressing the Select button or the Right Arrow button will save the new set temperature.

On the right side of the screen, the menu selections can be selected with the Up and Down Buttons. Use the Select Button to choose an item. Selecting one of these items will change to a different screen with additional controls.

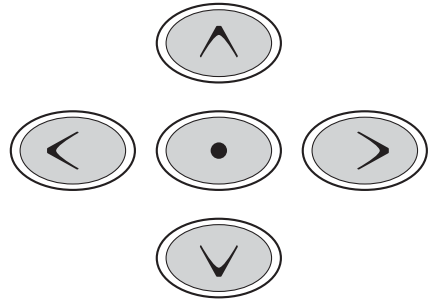
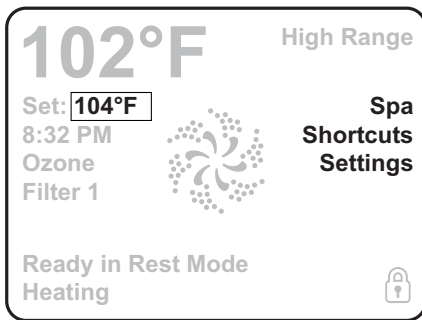

MESSAGES

At the bottom of the screen, messages may appear at various times. Some of these messages must be dismissed by the user. See "General Messages" section.

PRESS-AND-HOLD

If an Up or Down button is pressed and held when the Set Temperature is selected, the temperature will continue to change until the button is released, or the Temperature Range limits are reached.

THE SPA SCREEN AND SHORTCUT SCREEN - TS FIT

ALL EQUIPMENT ACCESS

The Spa Screen shows all available equipment to control, as well as other features, like Invert, in one easy-to-navigate screen. The display shows icons that are related to the equipment installed on a particular spa model, so this screen may change depending on the installation.

The navigation buttons are used to select an individual device. The device that is chosen is highlighted with a white outline and the text under the icon changes to white. Once a device is selected, it can be controlled using the center Select Button.

Some devices, like pumps, may have more than one ON state, so the icon will change to reflect the state that the equipment is in. Below are some examples of 2-speed Pump indicators.



Jets Off



Jets Low



Jets High

If the Spa has a 24 hour Circ Pump, a Circ Pump Icon will appear to indicate its activity, but outside of Priming Mode, the 24 hour Circ Pump cannot be controlled directly.

NOTE: The icon for the 24 hour pump that is associated with the heater will have a red glow in the center when the heater is running.

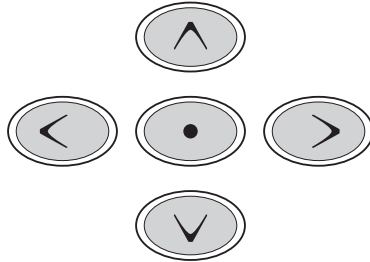
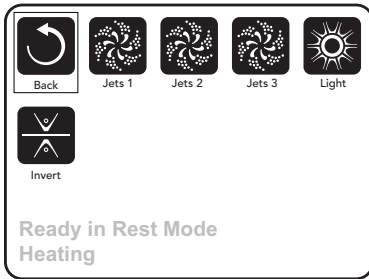

ONE-PRESS ACTIVATION

The Shortcut Screen requires no navigation. Each button is fixed on a specific function and can be used as a very simple user interface for the spa.

Each button function is illustrated in the display.

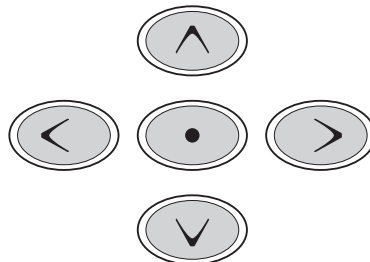
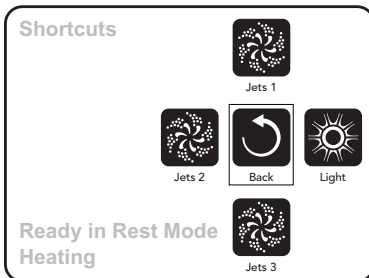

THE SETTINGS SCREEN - TS FIT

PRESSING A "BUTTON"

When instructions are given to "press a button" any of the following can be done:

- Navigate to the desired item on any Screen. When the desired item is highlighted, press the Select Button.
- Press the button for that device while on the Shortcuts Screen, if the device is one of the 4 functions available.

PROGRAMMING, ETC.

The Settings Screen is where all programming and other spa behaviors are controlled.

This screen has several features that can be acted on directly. These features include Temp Range, Heat Mode, and Invert Panel. When one of these items is highlighted, the Select Button is used to toggle between two settings.

All other menu items (with an arrow pointing to the right) go to another level in the menu.

PRESS-AND-HOLD

If an Up or Down button is pressed and held when an item in a Menu List is highlighted, the list can be scrolled quickly from top to bottom. The scroll bar on the right side of the screen indicates the relative position of the highlighted item in the list.

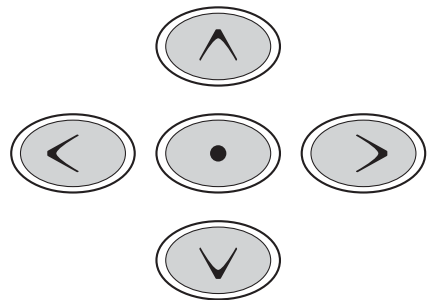
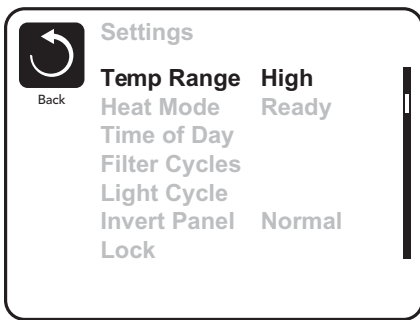

DUAL TEMPERATURE RANGES (HIGH VS. LOW)

This system incorporates two temperature range settings with independent set temperatures. The specific range can be selected on the Settings screen and is visible on the Main Screen in the upper right corner of the display.

These ranges can be used for various reasons, with a common use being a "ready to use" setting vs. a "vacation" setting. Each range maintains its own set temperature as programmed by the user. This way, when a range is chosen, the spa will heat to the set temperature associated with that range.

High Range can be set between 80°F and 104°F.

Low Range can be set between 50°F and 99°F.

Freeze Protection is active in either range.

THE SETTINGS SCREEN - TS FIT (CONTINUED)

HEAT MODE – READY VS. REST

In order for the spa to heat, a pump needs to circulate water through the heater. The pump that performs this function is known as the “24 hour Circ.”

REST Mode will only allow heating during programmed filter cycles.

Circulation Mode See “Spa Behavior” section.

The heater pump generally runs continuously. Since the heater pump is always running, the spa will maintain set temperature and heat as needed in Ready Mode, without polling.

In Rest Mode, the spa will only heat to set temperature during programmed filter times, even though the water is being filtered constantly when in Circulation Mode.

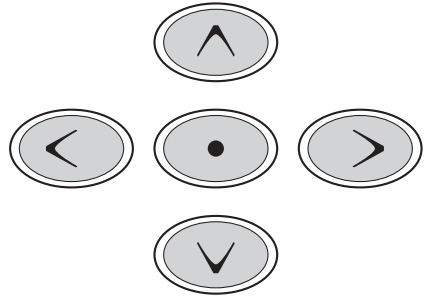
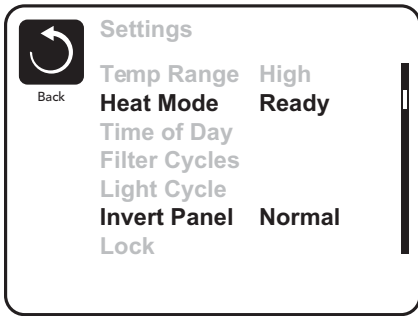

READY-IN-REST MODE

READY/REST appears in the display if the spa is in Rest Mode and the Jets 1 Button is pressed. It is assumed that the spa is being used and will heat to set temperature. After 1 hour, the System will revert to Rest Mode. This mode can also be reset by entering the Settings Menu and changing the Heat Mode.

FILL IT UP! - TS FIT

PREPARATION AND FILLING

Fill the spa to its correct operating level. Be sure to open all valves and jets in the plumbing system before filling to allow as much air as possible to escape from the plumbing and the control system during the filling process.

After turning the power on at the main power panel, the top-side panel will display a splash, or startup screen.

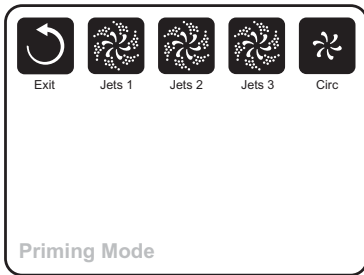

PRIMING MODE

After the initial start-up sequence, the control will enter Priming Mode and display a Priming Mode screen. Only pump icons appear on the priming mode screen. The system will automatically return to normal heating and filtering at the end of the priming mode, which lasts 4-5 minutes. During the priming mode, the heater is disabled to allow the priming process to be completed without the possibility of energizing the heater under low-flow or no-flow conditions. Nothing comes on automatically, but the pump(s) can be energized by selecting the "Jet" buttons.

The 24 hour Circ Pump can be activated by pressing the dedicated "Light" button during Priming Mode.

Manually exit Priming Mode by pressing the "Exit" Button.

PRIMING THE PUMPS

As soon as the Priming Mode screen appears on the panel, select the "Jets 1" button once to start Pump 1 in low-speed and then again to switch to high-speed. Also, select the other pumps, to turn them on. The pumps should be running in high-speed to facilitate priming. If the pumps have not primed after 2 minutes, and water is not flowing from the jets in the spa, do not allow the pumps to continue to run. Turn off the pumps and repeat the process. Note: Turning the power off and back on again will initiate a new pump priming session. Sometimes momentarily turning the pump off and on will help it to prime. Do not do this more than 5 times. If the pump(s) will not prime, shut off the power to the spa and call for service.

Important: A pump should not be allowed to run without priming for more than 2 minutes. Under NO circumstances should a pump be allowed to run without priming beyond the end of the 4-5 minute priming mode. Doing so may cause damage to the pump and cause the system to energize the heater and go into an overheat condition.

EXITING PRIMING MODE

You can manually exit Priming Mode by navigating to the "Back" button on the Priming Mode Screen. Note that if you do not manually exit the priming mode as described above, the priming mode will be automatically terminated after 4-5 minutes. Be sure that the pump(s) have been primed by this time.

Once the system has exited Priming Mode, the top-side panel will display the Main Screen, but the display will not show the temperature yet, as shown below. This is because the system requires approximately 1 minute of water flowing through the heater to determine the water temperature and display it.

-- °F -- °C

SPA BEHAVIOR - TS FIT

PUMPS

On the Spa Screen, select a “Jets” button once to turn the pump on or off, and to shift between low- and high-speeds if equipped. If left running, the pump will turn off after a time-out period. The pump 1 low-speed will time out after 30 minutes. The high-speed will time-out after 15 minutes.

CIRCULATION PUMP MODES

1. The 24 hour circ pump operates continuously with the exception of turning off for 30 minutes at a time when the water temperature reaches 3°F (1.5°C) above the set temperature (most likely to happen in very hot climates).

FILTRATION AND OZONE

The system is factory-programmed with one filter cycle that will run in the evening (assuming the time-of-day is properly set) when energy rates are often lower. The filter time and duration are programmable. See “Adjusting Filtration” section. A second filter cycle can be enabled as needed.

At the start of each filter cycle, the pumps will run briefly to purge the plumbing to maintain good water quality. On spas equipped with 24 hour circulation systems the filter cycles cannot be set. (See adjusting filtration section).

FREEZE PROTECTION

If the temperature sensors within the heater detect a low enough temperature, then the pumps automatically activate to provide freeze protection. The pumps will run either continuously or periodically depending on conditions. If the temperature sensors detect a drop to below 44°F/6.7°C within the heater, the pump will automatically activate to provide freeze protection. The equipment stays on until 4 minutes after the sensors detect that the spa temperature has risen to 45°F/7.2°C or higher. During freeze protection the heater will not be activated.

CLEAN-UP CYCLE

When a pump is turned on by a button press, a clean-up cycle begins 30 minutes after the pump is turned off or times out. The pump and the ozone generator will run for 30 minutes or more, depending on the system. This setting can be changed. See “Preferences” section.

TIME-OF-DAY - TS FIT

BE SURE TO SET THE TIME-OF-DAY

Setting the time-of-day is important for determining filtration times and other background features.

“Set Time” will appear on the display if no time-of-day is set in the memory.

On the Settings Screen, select the Time-of-Day line. On the Time-of-Day screen, simply navigate right and left to select the Hour, Minutes, AM/PM and 12/24 Hour segments. Use the Up and Down Buttons to make changes.

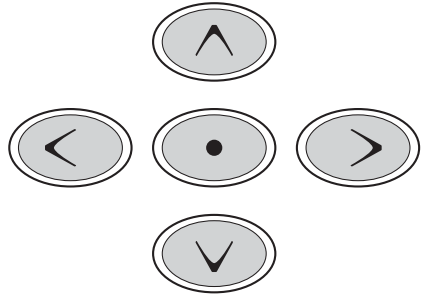
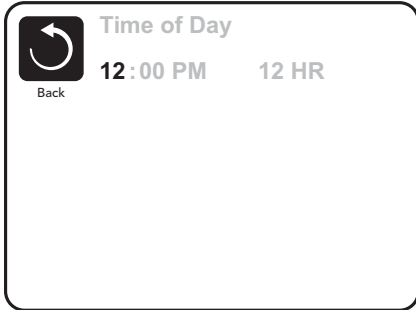

SAVING SETTINGS

The Time-of-Day screen is a simple, editable screen that illustrates a feature of the control that applies to all other editable screens as well.

When changes are made, the icon to go “Back” changes to “Save” and a new icon for “Cancel” appears under the Save icon. Navigating to the left will highlight the Save icon, and navigating down from there will allow the user to cancel the pending change. Pressing the “Select” button will save or cancel the changes and go back to the previous screen.

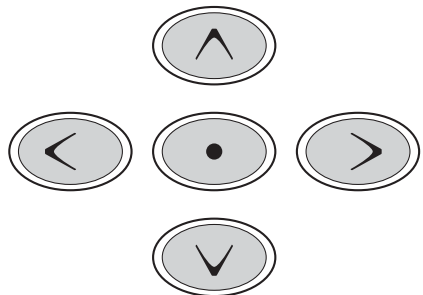
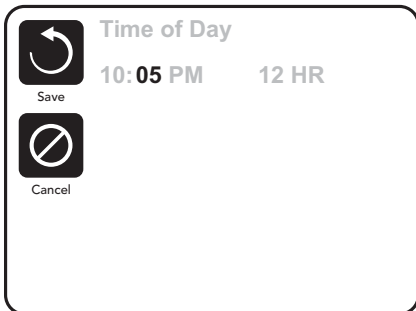

NOTE:

If power is interrupted to the system, Time-of-Day will be maintained for several days.

ADJUSTING FILTRATION - TS FIT

NOTE:

On spas that are equipped with a 24 hour circulation system the filter cycles are disabled. The water is filtered 24 hours a day so a filtration cycle is not necessary. The energy efficiency of the spa is also enhanced by disabling the filtration cycles. Although the filtration settings screens will still be visible they will not have any effect on filtration cycles.

On spas that are not equipped with 24 hour circulation systems the filtration settings will set times for the #1 jet pump to run on low speed for filtration.

MAIN FILTRATION

Using the same navigation and adjustment as Setting the Time, Filter Cycles are set using a start time and a duration. Each setting can be adjusted in 15-minute increments. The panel calculates the end time and displays it automatically.

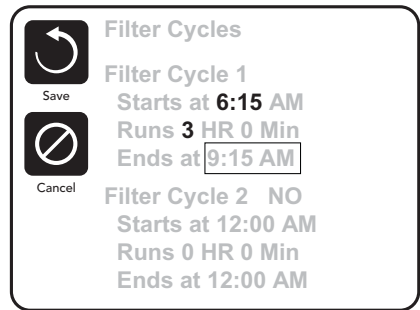
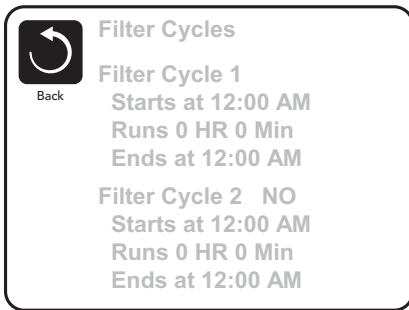

FILTER CYCLE 2 - OPTIONAL FILTRATION

Filter Cycle 2 is OFF by default.

Simply navigate to the Filter Cycle 2 line by pressing the Right Navigation Button, and when "NO" is highlighted, press Up or Down to toggle Filter Cycle 2 on and off. When Filter Cycle 2 is ON, it can be adjusted in the same manner as Filter Cycle 1 by navigating to the right.

It is possible to overlap Filter Cycle 1 and Filter Cycle 2, which will shorten overall filtration by the overlap amount.

CIRCULATION PUMP MODES

The 24 Circ Pump is programmed to operate continuously.

PURGE CYCLES

In order to maintain sanitary conditions, as well as protect against freezing, will purge water from their respective plumbing by running briefly at the beginning of each filter cycle. The spa will always initiate purge cycles whether it is equipped with a 24 hour circulation system or not to insure that water is purged from the plumbing lines.

If the Filter Cycle 1 duration is set for 24 hours, enabling Filter Cycle 2 will initiate a purge when Filter Cycle 2 is programmed to begin.

ADDITIONAL SETTINGS - TS FIT

INVERT PANEL

Selecting Invert Panel will flip the display and the buttons so the panel can be easily operated from inside or outside the hot tub.

DEDICATED BUTTONS

SPECIFIC BUTTONS FOR SPECIFIC DEVICES

The panel has dedicated function buttons installed, pressing those buttons will activate the device indicated for that button.

These dedicated buttons will operate just like the Spa Screen buttons (See "Spa Screen and Shortcut screen" section.) and the equipment will behave in the same manner with each button press.

RESTRICTING OPERATION - TS FIT

The control can be restricted to prevent unwanted use or temperature adjustments.

Locking the Panel prevents the controller from being used, but all automatic functions are still active.

Locking the Settings allows Jets and other features to be used, but the Set Temperature and other programmed settings cannot be adjusted.

Settings Lock allows access to a reduced selection of menu items. These include Set Temperature, Invert, Lock, Utilities, Information and Fault Log. They can be seen, but not changed or edited.

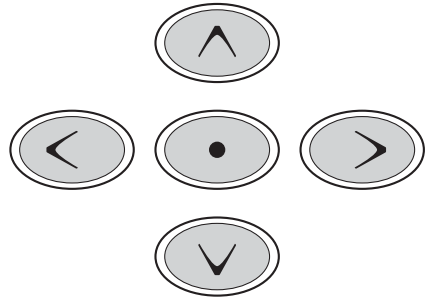
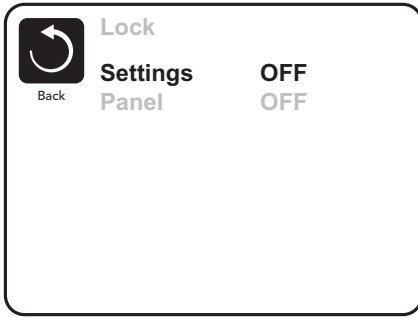

UNLOCKING

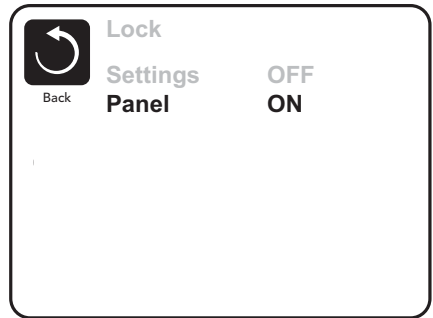

An **Unlock Sequence** using the navigation buttons can be used from the Lock Screen. The Unlock Sequence is the same for both Panel Lock and Settings Lock.



ADDITIONAL SETTINGS - TS FIT

HOLD MODE

Hold Mode is used to disable the pumps during service functions like cleaning or replacing the filter. Hold Mode will last for 1 hour unless the mode is exited manually. If spa service will require more than an hour, it may be best to simply shut down power to the spa.

UTILITIES

The Utilities Menu contains the following:

A/B Temps

When this is set to On, the temperature display will alternate to display temperature from Sensor A and Sensor B in the heater.

Fault Log

The Fault Log is a record of the last 24 faults that can be reviewed by a service tech.



Back

Fault Log

Entry 2

Message Code M026
1 Days Ago 2:21PM

Rest Mode
High Range
Set Temp 104°F
Sensors: A: 100 B: 96

Message:
Sensors are out of sync

ADDITIONAL SETTINGS - TS FIT

PREFERENCES

The Preferences Menu allows the user to change certain parameters based on personal preference.

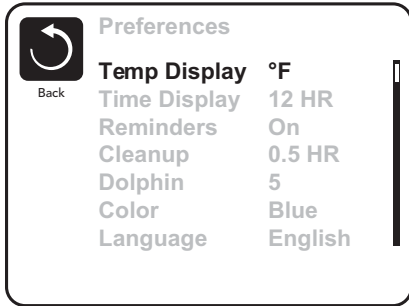

Temp Display

Change the temperature between Fahrenheit and Celsius.

Time Display

Change the clock between 12 hr and 24 hr display.

Cleanup

Cleanup Cycle Duration default is 30 minutes. The duration can be set in 30 minute increments for up to 4 hours. The #1 jet pump will run for the time duration set 30 minutes after any of the jets pumps have been activated.

Color

Pressing the Select Button when Color is highlighted will cycle through 5 background colors available in the control.

Language

Change the language displayed on the panel.

SYSTEM INFORMATION

The System Information Menu displays various settings and identification of the particular system. As each item in the menu is highlighted, the detail for that item is displayed at the bottom of the screen. These settings are for information only and cannot be changed.

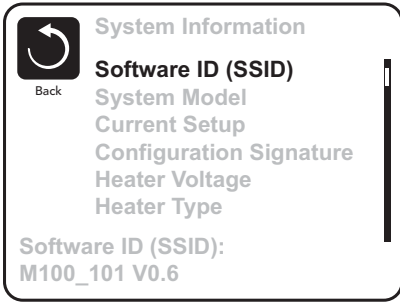

Software ID (SSID)

Displays the software ID number for the System.

System Model

Displays the Model Number of the System.

Current Setup

Displays the currently selected Configuration Setup Number.

Configuration Signature

Displays the checksum for the system configuration file.

Heater Voltage (Feature not used on CE rated systems.)

Displays the operating voltage configured for the heater.

Heater Wattage as Configured in Software (CE Systems Only.)

Displays a heater kilowatt rating as programmed into the control system software (1-3 or 3-6).

Heater Type

Displays a heater type ID number.

Dip Switch Settings

Displays a number that represents the DIP switch positions of S1 on the main circuit board.

Panel Version

Displays a number of the software in the topside control panel.

GENERAL MESSAGES - TS FIT

Most messages and alerts will appear at the bottom of the normally used screens. Several alerts and messages may be displayed in a sequence.

Some messages can be reset from the panel. Messages that can be reset will appear with a “right arrow” at the end of the message. This message can be selected by navigating to it at pressing the Select button.

---°F--- °C

WATER TEMPERATURE IS UNKNOWN

After the pump has been running for 1 minute, the temperature will be displayed.

POSSIBLE FREEZING CONDITION

A potential freeze condition has been detected. All pumps are activated.

In some cases, pumps may turn on and off and the heater may operate during Freeze Protection.

This is an operational message, not an error indication.

THE WATER IS TOO HOT

The system has detected a spa water temp of 110°F (43.3°C) or more, and spa functions are disabled. System will auto reset when the spa water temp is below 108°F (42.2°C). Check for extended pump operation or high ambient temp.

* This message can be reset from the topside panel.

HEATER-RELATED MESSAGES - TS FIT

THE WATER FLOW IS LOW

There may not be enough water flow through the heater to carry the heat away from the heating element. Heater start up will begin again after about 1 min. See "Flow Related Checks" below.

THE WATER FLOW HAS FAILED*

There is not enough water flow through the heater to carry the heat away from the heating element and the heater has been disabled. See "Flow Related Checks" below. After the problem has been resolved, you must press any button to reset and begin heater start up.

THE HEATER MAY BE DRY*

Possible dry heater, or not enough water in the heater to start it. The spa is shut down for 15 min. Press any button to reset the heater start-up. See "Flow Related Checks" below.

THE HEATER IS DRY*

There is not enough water in the heater to start it. The spa is shut down. After the problem has been resolved, you must clear the message to restart heater start up. See "Flow Related Checks" below.

THE HEATER IS TOO HOT*

One of the water temp sensors has detected 118°F (47.8°C) in the heater and the spa is shut down. You must clear the message when water is below 108°F (42.2°C). See "Flow Related Checks" below.

FLOW-RELATED CHECKS

Check for low water level, clogged filters, suction flow restrictions, closed valves, trapped air, too many closed jets and pump prime.

On some systems, even when spa is shut down by an error condition, some equipment may occasionally turn on to continue monitoring temperature or if freeze protection is needed.

* This message can be reset from the topside panel.

SENSOR-RELATED MESSAGES - TS FIT

SENSORS ARE OUT OF SYNC

The temperature sensors MAY be out of sync by 2°F or 3°F. Call for Service.

SENSORS ARE OUT OF SYNC -- CALL FOR SERVICE*

The temperature sensors ARE out of sync. The fault above has been established for at least 1 hour. Call for Service.

SENSOR A FAULT, SENOR B FAULT

A temperature sensor or sensor circuit has failed. Call for Service.

MISCELLANEOUS MESSAGES

COMMUNICATIONS ERROR

The control panel is not receiving communication from the System. Call for Service.

TEST SOFTWARE INSTALLED

The Control System is operating with test software. Call for Service.

°F OR °C IS REPLACED BY °T

The Control System is in Test Mode. Call for Service.

* This message can be reset from the topside panel.

SYSTEM-RELATED MESSAGES - TS FIT

PROGRAM MEMORY FAILURE*

At Power-Up, the system has failed the Program Checksum Test. This indicates a problem with the firmware (operation program) and requires a service call.

THE SETTINGS HAVE BEEN RESET (PERSISTENT MEMORY ERROR)*

Contact your dealer or service organization if this message appears on more than one power-up.

THE CLOCK HAS FAILED*

Contact your dealer or service organization.

CONFIGURATION ERROR (SPA WILL NOT START UP)

Contact your dealer or service organization.

A PUMP MAY BE STUCK ON

Water may be overheated. POWER DOWN THE SPA. DO NOT ENTER THE WATER. Contact your dealer or service organization.

HOT FAULT

A Pump Appears to have been Stuck ON when spa was last powered

POWER DOWN THE SPA. DO NOT ENTER THE WATER. Contact your dealer or service organization.

* This message can be reset from the topside panel.

TWILIGHT SPA – CONTROLS TS 120



INITIAL START-UP

When your spa is first actuated, it will go into Priming mode, indicated by "Pr". The Priming mode will last for less than 5 minutes (press "Warm" or "Cool" to skip Priming mode) the spa will begin to heat and maintain the water temperature in the Standard mode.

Warm / Cool (80°F-104°F / 26°C-40°C)

The start-up temperature is set at 100 degrees F / 37 degrees C. The last measured temperature is constantly displayed on the LCD display.

To display the set temperature, press the "Warm" or "Cool" button once.

To change the set temperature, press the button a second time before the LCD stops flashing. Each press of the "Warm" or "Cool" button will continue to either raise or lower the set temperature.

After three seconds, the LCD will stop flashing and display the current spa temperature.

Jets

Press the jets button once to activate the pump on low speed. Press the jets button again to turn the pump on high speed. If left running on low speed the pump will automatically turn off after 4 hours, and the high speed will automatically turn off after 15 minutes.

L.E.D. Lights

Press the "Light" button to turn the light on and off. If you wish to change the "function" of the lights, turn the lights off, then on within 5 seconds.

Mode

Mode is changed by pressing the "warm" or "cool" then "Light Button".

Standard Mode is programmed to maintain the desired temperature. Note that the last measured spa temperature displayed is current only when the low speed of pump 1 has been running for at least 2 minutes. "SL" will be displayed momentarily when you switch into Standard Mode.

Economy Mode heats the spa to the set temperature only during filter cycles. "EC" will display solid when temperature is not current, and will alternate with temperature when temperature is current.

Sleep Mode heats the spa to within 20°F/10°C of the set temperature only during filter cycles. "SL" will display solid when temperature is not current, and will alternate with temperature when temperature is current.

Preset Filter Cycles

The first filter cycle begins 6 minutes after the spa is energized. The second filter cycle begins 12 hours later. Filter duration is programmable for 2, 4, 6, 8 hours or for continuous filtration (indicated by "FC"). The default filter time is 2 hours.

To program, press "warm" or "cool" then "Jets." Press "warm" or "cool" to adjust. Press "Jets" to exit programming.

At the beginning of each filter cycle the pump(s) purge for 30 seconds; the pump purges for 5 minutes. The only effect filter duration has is: 1) During the filter, the low-speed of pump 1 never turns off, and 2) In Economy and Sleep Modes, heating only occurs during the filter cycle.

Freeze Protection

If the temperature sensors detect a drop to below 44°F/6.7°C within the heater, the pump will automatically activate to provide freeze protection. The equipment stays on until 4 minutes after the sensors detect that the spa temperature has risen to 45°F/7.2°C or higher. During freeze protection the heater will not be activated.

TWILIGHT SPA – DIAGNOSTIC MESSAGES - TS 120

MESSAGE	MEANING	ACTION REQUIRED
	No message on display. Power has been cut off to the spa.	The control panel will be disabled until power returns. Spa settings will be preserved until next power up.
--	Temperature unknown.	After the pump has been running for 2 minutes, the temperature will be displayed.
HH	"Overheat" - The spa has shut down. One of the sensors has detected 118°F/48°C at the heater.	DO NOT ENTER THE WATER. Remove the spa cover and allow water to cool. Once the heater has cooled, reset by pushing any button. If spa does not reset, shut off the power to the spa and call your dealer or service organization.
OH	"Overheat" - The spa has shut down. One of the sensors has detected that the spa water is 110°F/43°C.	DO NOT ENTER THE WATER. Remove the spa cover and allow water to cool. At 107°F/42°C, the spa should automatically reset. If spa does not reset, shut off the power to the spa and call your dealer or service organization.
IC	"Ice" - Potential freeze condition detected.	No action required. The pump(s) will automatically activate regardless of spa status.
SA	Spa is shut down. The sensor that is plugged into the Sensor "A" jack is not working.	If the problem persists, contact your dealer or service organization. (May appear temporarily in an overheat situation and disappear when the heater cools.)
Sb	Spa is shut down. The sensor that is plugged into the Sensor "B" jack is not working.	If the problem persists, contact your dealer or service organization. (May appear temporarily in an overheat situation and disappear when the heater cools.)
Sn	Sensors are out of balance. If alternating with spa temperature, it may just be a temporary condition. If flashing by itself, spa is shut down.	If the problem persists, contact your dealer or service organization.
HL	A significant difference between temperature sensors has been detected. This could indicate a flow problem.	Check water level in spa. Refill if necessary. If the water level is okay, make sure the pumps have been primed. If problem persists, contact your dealer or service organization.
LF	Persistent low flow problems. (Displays on the fifth occurrence of "HL" message within 24 hours.) Heater is shut down, but other spa functions continue to run normally.	Follow action required for "HL" message. Heating capability of the spa will not reset automatically; you may press any button to reset. Check filters for possible blockage.
dr	Possible inadequate water, poor flow, or air bubbles in detected in the heater. Spa is shut down for 15 minutes.	Check water level in spa. Refill if necessary. If water level is okay, make sure the pump(s) have been primed. Press any button to reset, or this message will automatically reset within 15 minutes. If problem persists, contact your dealer or service organization.
dy	Inadequate water detected in heater. (Displays on third occurrence of "dr" message.) Spa is shut down.	Follow action required for "dr" message. Spa will not automatically reset. Press any button to reset.

Warning! Shock Hazard! No User Serviceable Parts. Do not attempt service of this control system. Contact your dealer or service organization for assistance. Follow all owner's manual power connection instructions. Installation must be performed by a licensed electrician and all grounding connections must be properly installed.

STANDARD FUSION AUDIO SYSTEM



Warning: Never remain in your spa longer than 15 minutes per session when the water temperature is above 98°F. If you wish to spend more time in your spa, whether enjoying music, or just lounging, be sure to keep the spa water at or below body temperature (98.6°F).

**Please refer to your stereo Owner's Manual for specific operations.*

Optional Stereo Station

Your spa is equipped with a media locker station that will allow you to listen to personal selections through the audio system of the spa.

The media locker station is compatible with most portable audio products. Master Spas, Inc. does not guarantee compatibility with all portable audio products due to software changes and upgrades.

POWER ON

To activate the Digital Media Locker™, press the standby button on the locker, LED will turn red. To turn on the stereo, press the ON/OFF button located on the door mounted keypad.

1. Press + (VOLUME UP) once to increase the volume by 3 decibels.
2. Press - (VOLUME DOWN) once to decrease the volume by 3 decibels. Press and hold either UP or DOWN button on the Digital Media Locker™ to increase or decrease audio volume continuously.
3. Audio information is passed from you portable device via the 3.5mm connector inside the locker door.

Buttons		
Power		Press once: toggle from Operation mode to Standby mode or vise versa.
Volume up		Press once: Volume UP a value Press and hold: Fast volume up
Volume down		Press once: Volume DOWN a value Press and hold: Fast volume down

CAUTION – Risk of Electric Shock. Do not leave compartment door open.

CAUTION – Risk of Electric Shock. Replace components only with identical components; and

Do not operate the Audio / Video controls while inside the spa.

WARNING – Prevent Electrocution. Do not connect any auxiliary components (for example cable, additional speakers, headphones, additional Audio / Video components, etc.) to the system.

NOTE: These units are not provided with an outdoor antennae; when provided, it should be installed in accordance with article 810 of the National Electrical Code, ANSI / NFPA 70.

NOTE: Do not service this product yourself as opening or removing covers may expose you to dangerous voltage or other risk of injury. Refer all servicing to qualified service personnel.

DELUXE FUSION AUDIO SYSTEM



Warning: Never remain in your spa longer than 15 minutes per session when the water temperature is above 98°F. If you wish to spend more time in your spa, whether enjoying music, or just lounging, be sure to keep the spa water at or below body temperature (98.6°F).

**Please refer to your stereo Owner's Manual for specific operations.*

Optional Stereo Docking Station

Your spa is equipped with an iPod™ docking station that will allow you to listen to personal selections through the audio system of the spa. This audio system also has an FM only radio receiver that can be used to listen to local FM broadcasts. Due to varying signal conditions the FM radio reception may be limited.

The docking station is compatible with most iPod™ products. Master Spas, Inc. does not guarantee compatibility with all iPod™ products due to software changes and upgrades.

The wireless remote provided with the spa is water resistant, but should never be left in the spa when not in use.

Power On

To activate the Digital Media Locker™, press the on/off button, standby mode will be indicated by a red LED. ON mode will be indicated by a blue LED. When the unit is in the standby position the red LED will be lit.

Remote Synchronizing

Press and hold MODE button on the remote. The display will then show "pair". Keep pressing this key. Then press the power button on the locker from off(no light) to standby (red light)to pair with the locker. If the pairing is successful it will show "welcome" and the LED on the locker will turn blue. If pair is not successful. Please repeat the step above.













Each Digital Media Locker™ comes with a matching RF (Radio Frequency) Wireless LCD Remote control. This remote is required use any functions on the unit. For any additional remote controls, you will need to activate/Synchronize those remote controls to the main unit by following the steps above.

The remote control uses state-of-the-art technology and will inform you if the dock is receiving the command from the remote control. In any case, if the LCD displays "NO LINK" this means that your Locker is off or remote control is out of reception range.

Each Digital Media Locker™ comes with a matching RF (Radio Frequency) Wireless LCD remote control. This remote is required to use any functions on the unit. For any additional remote controls you will need to activate/synchronize those remote controls to the stereo by following the steps above.

If you lose your remote control and buy a replacement, follow the steps above to pair/synchronize before normal usage.

DELUXE FUSION AUDIO SYSTEM

Buttons		Music Mode	FM Radio Mode
Power		Press once: toggle from Operation mode to Standby mode or vice versa.	
12V trigger /Random		Press once: random function Press and hold: Toggle external power	Press once: No function. Press and hold: Toggle external power
Volume up		Press once: Volume UP a value Press and hold: Fast volume up	Press once: Volume UP a value Press and hold: Fast volume up
Volume down		Press once: Volume DOWN a value Press and hold: Fast volume down	Press once: Volume DOWN a value Press and hold: Fast volume down
Mode		Press once: Change the source. Press and hold: Pair	Press once: Change the source. Press and hold: Pair
Audio		Press once: Enter BAL-FAD-DSP-LOUD-VOL	Press once: Enter BAS-TRE-BAL-FAD-DSP-AREA-LOUD-DX-STEREO-VOL.
1/DIR-		Press once: back to previous folder. Press and hold: back to previous folder.	Press once: Listen to the station which in the No.1 Press and hold: stored a station into No. 1.
2/Repeat		Press once: repeat function. Press and hold: repeat function.	Press once: Listen to the station which in the No.2 Press and hold: stored a station into No. 2.
3/DIR+		Press once: to next folder. Press and hold: to next folder.	Press once: Listen to the station which in the No.3 Press and hold: stored a station into No. 3.
Fast Rewind		Press once: Last track Press and hold: Fast Rewind	Press once: seek down Press and hold: change to manual scanning
Pause/ Play		Press once: Play/Pause Press and hold: Play/Pause	Press once: toggle mute Press and hold: toggle mute
Fast Forward		Press once: Next track Press and hold: Fast Forward	Press once: seek up. Press and hold: change to manual scanning

- I** If your music player is not an ipod, you will not be able to control track or receive track information
- I** In order to prolong remote battery life the LCD will shut off in 20 seconds if no other button is pressed. To turn remote back on press any key once and then press the command desired.
- I** Shut off DSP to access control of Bass and Treble control

CAUTION – Risk of Electric Shock. Do not leave compartment door open.

CAUTION – Risk of Electric Shock. Replace components only with identical components; and

Do not operate the Audio / Video controls while inside the spa.

WARNING – Prevent Electrocution. Do not connect any auxiliary components (for example cable, additional speakers, headphones, additional Audio / Video components, etc.) to the system.

NOTE: These units are not provided with an outdoor antennae; when provided, it should be installed in accordance with article 810 of the National Electrical Code, ANSI / NFPA 70.

NOTE: Do not service this product yourself as opening or removing covers may expose you to dangerous voltage or other risk of injury. Refer all servicing to qualified service personnel.

SPA TROUBLE-SHOOTING GUIDE

NOTHING ON THE SPA OPERATES-

- 1.) Check the control panel display for any messages. If there is a message, refer to the diagnostic section. There you will find the meaning of the message and what action is to be taken.
- 2.) If there is no message on your control panel, check and reset the GFCI and house breaker. If the spa does not respond; contact your local service company.

TS 120 only: The GFCI cord should be plugged into a weather proof receptacle close to the spa, but no closer than 5 ft. to the spa. If the spa does not respond make sure to check and reset the GFCI breaker attached to the plug end of the cord.



**The GFCI should be located in a weather proof box close to the spa, but no closer than 5 ft.*

If the spa does not respond, contact your local service company.

PUMP(S) DO NOT OPERATE -

- 1.) Press the "Jets" button on your control panel.
If you hear the pumps trying to operate:
 - A. Pump may need to be primed. See page 17.If you do not hear anything from the pump, contact your local service company.

POOR JET PERFORMANCE

- 1.) Make sure pump is operating
- 2.) Check that the water level is adequate (up to minimum safe water level side)
- 3.) Make sure the jets are open.
- 4.) Check for dirty filter. Clean if necessary.

SPA TROUBLE-SHOOTING GUIDE

SPA NOT HEATING

* If the spas heater has failed, the majority of the time it will trip the GFCI breaker. If the spa is not heating and has not tripped the breaker, please follow these steps:

- 1.) Check the control panel for diagnostic messages. Refer to spa diagnostic message area in previous sections. Follow steps to alleviate message.
- 2.) Check water set temperature at control panel.
- 3.) Check for dirty filter. Clean if necessary.
- 4.) Check "heat mode" the spa is set in. Spa should be in standard/ready mode.
- 5.) Check the control panel for heater light indicator. If the light is on, the spa should be heating. Wait a reasonable amount of time (approximately 1 hour) to see if the water temperature is changing.
- 6.) Check to make sure that the pump is primed.
- 7.) Reset power to the spa at GFCI breaker.
- 8.) If spa is still not heating, contact your dealer for service.



GFCI IS TRIPPING

A ground fault circuit interrupter (GFCI) is required by the National Electrical Code for your protection. The tripping of the GFCI may be caused by a component on the spa or by an electrical problem. Electrical problems include but are not limited to, a faulty GFCI breaker, spa component, power fluctuations, or improper wiring. It may be necessary to contact an electrician if your dealer recommends doing so.

REGULAR MAINTENANCE PROCEDURES

Note: These are maintenance procedures are the responsibility of the spa owner to perform. These procedures are not covered by the spa warranty.



CLEANING JETS

The majority of jets in your spa can individually be turned on/off. If any of these jets become hard to turn, it will be necessary to remove the jet to clean it as grit/sand and mineral deposit may be present.

The jets in your spa can be removed for cleaning by unscrewing them (counter clockwise) and then pulling out the jet. Some jets may not be removable depending on the model.

TO CLEAN JETS

Place the jet(s) in a container, fully immerse in white vinegar. Let the jet(s) soak overnight and then rinse with water. Reinstall the jet(s). It may be necessary to clean grit and deposits from the white jet body (mounted in the spa shell) by using a small bristled brush.



DRAINING YOUR SPA

The drain is located behind the front panel on the far right side, grasp the hose bib cap and turn it counter clockwise. Attach a garden hose, if desired. Turn the black knob on the side of the valve a quarter turn. Draining times may vary by model using the external hose bib. A sump pump may also be used to drain the spa quickly.

NOTE: When pushing or pulling the assembly in or out, water will drip from the drain during the transition. This is normal.



TS 120 and TS 240 only. The drain is located behind the front panel of the spa, grasp the hose bib cap and turn it counter clockwise. Attach a garden hose, if desired. Turn the black knob on the side of the valve a quarter turn. Draining times may vary by model using the external hose bib. Be sure to replace the cap once the spa has been drained.

TS Fit only. The TS Fit does not have a conventional pull out drain as show above. Due to the physical size of the TS Fit , we recommend draining this spa with a submersible sump pump. Draining this spa with a conventional spa drain is not a reasonable option.

REGULAR MAINTENANCE PROCEDURES

CARE OF YOUR SPA COVER

Always cover your spa when not in use. This will greatly reduce energy consumption and will cause spa water to heat more rapidly. Water loss and chemical usage will also be reduced.

- Be sure to lock down all straps on cover after each use to prevent wind damage.
- Do not allow spa to sit uncovered in direct sunlight. This may cause damage to exposed surfaces of spa and possible discoloration of spa fittings.
- Periodically hose off both sides of spa cover for maximum life of cover. Once a month use a vinyl cleaner and conditioner on the vinyl portion of your cover. Rinse residue off.
- Keep cover open for 15 min. after adding chemicals to prevent off gas damage.

NOTE: IF YOUR SPA IS GOING TO BE LEFT EMPTY FOR PROLONGED PERIODS, DO NOT REPLACE COVER DIRECTLY ON SURFACE OF SPA. PLACE 2"-3" BLOCKS BETWEEN COVER AND SPA. THIS ALLOWS FOR ADEQUATE VENTILATION OF COVER AND SPA.

NOTE: The cover warranty is provided through the cover manufacturer and not through Master Spas. You will need to mail the cover warranty back to the cover manufacturer.

CARE OF YOUR SPA CABINET

Your quality Polymer Skirt simply needs to be hosed off periodically. No other maintenance is required.



FILTER CLEANING

NOTE: Never operate the spa without filter in place. If done, damage will result to pumps and other components. We recommend having an extra filter to install when cleaning the filter.

- 1.) Turn power off to the spa.
- 2.) Remove any large or floating debris from the filter area.
- 3.) Remove the filter. Filter should be periodically rinsed and soaked in a cartridge cleaner. Follow cartridge cleaner instructions.
- 4.) Care must be taken not to overtighten the filters when installing them. they only need to be lightly snugged. Over tightening the filter could cause the threaded portion to become lodged in the filter bulkhead.



TS 120 and TS 240 Only

MAINTENANCE RECOMMENDATIONS

STAINLESS STEEL

Master Spas uses stainless steel in a number of our spas. Its lasting beauty and resistance to corrosion make it an excellent material for handrails and jets faces.

With the proper care it will keep its luster for many years. All stainless steel can corrode given the right circumstances so we have provided a guide to help you keep the stainless components in your spa looking nice.

Stainless steel derives its ability to resist corrosion by forming a very thin transparent coating on the surface when exposed to oxygen. This coating can be damaged by abrasive materials such as steel wool, sand paper, and other cleaning materials that are abrasive. Chlorine salts, sulfides, or other rusting metals can also erode this thin coating exposing the metal to corrosion.

The best defense to combat corrosion on stainless steel components in your spa is make sure that it is kept clean and free of any chemical build up.

Always:

- Clean frequently with clear clean water.
- Remove any rust spots as soon as they appear with vinegar or a brass, silver, or chrome cleaner.
- Use a good car cleaning wax for extra protection.

Never:

- Clean with mineral acids or bleaches.
- Clean with steel wool or any other abrasive material.
- Leave in contact with iron, steel any other metals.

NOTE: Failure to take proper care of the stainless steel fixture could result with them rusting. Rusting is not covered by the warranty.

NOTE: Do not cover the spa for 15 minutes after adding chemicals as the off gas can cause unwarranted damage.

WARNING:

BEFORE PERFORMING ANY MAINTENANCE ON THE MAST3RPUR SYSTEM, MAKE SURE THE SPA IS SHUT DOWN.

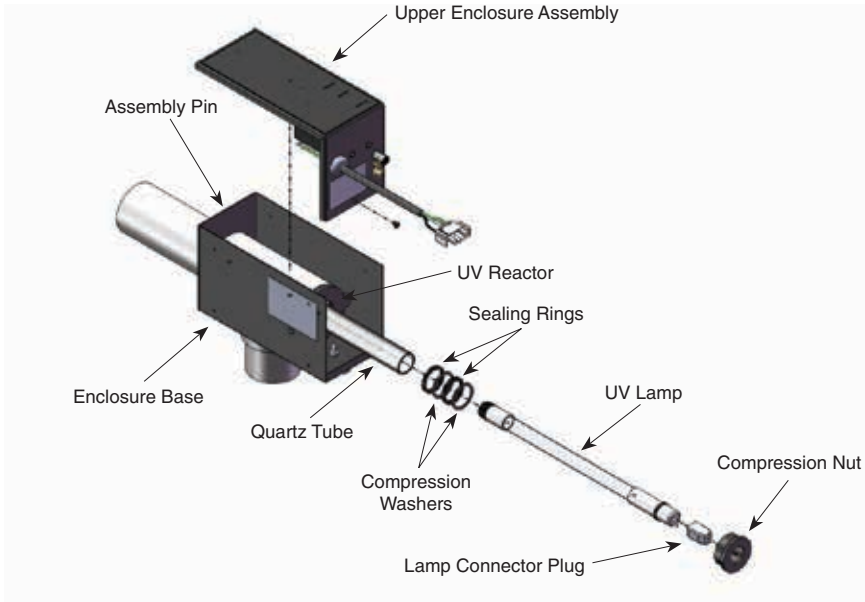

Figure 2: Mast3rPur System Exploded View

a. UV Lamp Removal – See Figure 2.

If the Green Power Indicator is on, but the Blue UV Lamp Indicator is off, the UV lamp needs to be replaced. However, the UV lamp useful life is 18 months. The Lamp must be replaced after 18 months of use, even if the Blue UV Lamp Indicator is still lit.

- i. Make sure the unit is disconnected from power and the lamp has cooled before starting maintenance.
- ii. Open the Mast3rPur System by removing the screw on the bottom of the Upper Enclosure Assembly, rotating it up and pushing it back to release it from the Assembly Pin.
- iii. Unplug the Lamp Connector Plug attached to the end of the UV Lamp and place the Upper Enclosure Assembly in a safe place.
- iv. Slowly pull the UV Lamp out of the Quartz Tube by the white ceramic prong end. **DO NOT TOUCH THE UV LAMP GLASS WITH YOUR BARE HANDS.** The oils on your hands can cause hot spots on the lamp and shorten its life. If oil from your fingers is left on the lamp glass, clean it off with a soft towel and rubbing alcohol. If you are removing an old lamp for replacement, handle the lamp carefully and dispose properly (see Environmental Notice below).
- v. Make sure the two o-rings and the end cushion remain on the ceramic ends of the lamp as it is set aside in a safe place.

b. Installing the UV Lamp

- i. Make sure to handle the new lamp as described in Section A and clean the UV Lamp before installation if needed.
- ii. Slowly place the UV Lamp into the Quartz Tube until it contacts the bottom of the tube.
- iii. Connect the Lamp Connector Plug to the pins on the lamp.

NOTE: Do not force the Lamp Connector Plug onto the pins. If force is needed, it means that the components are misaligned.

ENVIRONMENTAL NOTICE: UV Lamp CONTAINS MERCURY. Manage in accordance with disposal laws. See: www.lamprecycle.org

c. UV Reactor Service and Maintenance

The UV Lamp is housed in a Quartz Tube. If the Quartz Tube becomes dirty, its ability to transmit rays from the UV Lamp will be diminished and decrease system performance. The Quartz Tube should be removed from the UV Reactor at least once a year, or during a routine spa water change for inspection and cleaning if necessary. **DO NOT REMOVE THE QUARTZ TUBE WITH WATER IN THE SPA**

d. Quartz Tube Removal and Cleaning

CAUTION: Wear proper eye and skin protection for servicing glass components.

- i. Make sure the spa is shut down the water removed from the spa, and that the UV Lamp and Quartz Tube have cooled before performing maintenance on the Quartz Tube.
- ii. Remove the Upper Enclosure Assembly and UV Lamp as described in Section A and set aside in a safe place.
- iii. Remove the plastic Compression Nut. If there is any water remaining in the plumbing, it will start to leak after the Compression Nut is removed.
- iv. Grasp the inside of the Quartz Tube and pull it out of the housing. Make sure the Sealing Rings and Compression Washers do not get lost during Quartz Tube removal.
- v. Inspect the Sealing Ring for nicks or hardness and the Compression Washers for cracks, replace if necessary.
- vi. Clean the Quartz Tube exterior with a mild solution of muriatic acid and water in a ratio of four parts water to one part acid (4:1). **DO NOT USE ABRASIVE CLEANERS** as they can scratch the high quality quartz glass.

CAUTION: Follow the directions for safe use and handling of muriatic acid on the acid bottle label.

- vii. After cleaning the Quartz Tube, wash it off with water and wipe dry with a soft towel. Inspect the Quartz Tube for cracks and replace if cracks are found.
- viii. Make sure the inside of the Quartz Tube is dry before replacing the UV Lamp(s).

NOTE: Damage caused by broken quartz tubes is not covered under the Mast3rPur System Limited Warranty.

CAUTION: If broken glass is trapped in the spa system, do not operate the spa. contact a service professional to have the glass removed.

e. Quartz Tube Installation

- i. Arrange the Sealing Rings and Compression Washers on the Quartz Tube as shown in Figure 3.

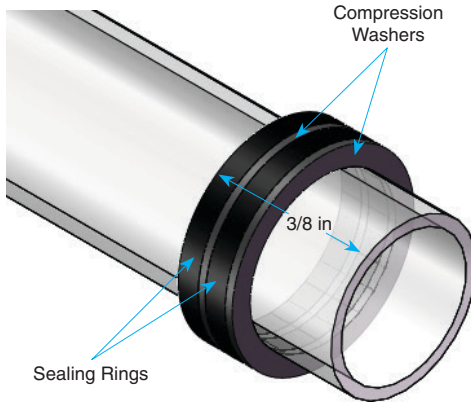

Figure 3: Quartz Tube Seal Assembly Detail

- ii. Insert the Quartz Tube partially into the UV Reactor. Place the Compression Nut over the open end of the Quartz Tube and slowly push in till it is resting against the threads on the UV Reactor.
- iii. Screw the Compression Nut into the threads till it is finger tight. **DO NOT OVERTIGHTEN.**
- iv. After spa is refilled, turn the spa ON and check the seal around the Quartz Tube for leaks.
- v. Correct any leak found by carefully tightening the Compression Nut no more than one turn.
- vi. SHUT DOWN the spa once you have confirmed that there are no leaks.
- vii. Install the UV Lamp as described in Section B.
- viii. Reinstall the Upper Enclosure Assembly to the Enclosure Base. Make sure the Assembly Pin is fitted through the hole in flange of the Enclosure Base before you screw the Upper Enclosure Assembly in place.
- ix. The unit is now ready for normal operation.

Contact your Master Spas dealer for replacement Mast3rPur parts.

ACCESSORY WI FI MODULE (TS FIT ONLY)

The spa control system in your spa has the ability to accept an accessory Wi Fi module that will allow you to connect the spa to your phone and home network when installed. This accessory Wi Fi module is available thru your dealer. This module will need to be connected to the spa control pack located behind the front panel of your spa. Please refer to the Balboa Water Group website for installation and operation information.

<http://www.balboawater.com/bwa>

SPA CARE AND MAINTENANCE RECORD

DATE DATE DATE DATE DATE DATE DATE DATE

Drain & Clean Spa								
Clean Filter Cartridge								
Soak Filter Cartridge in Solution								
Test GFCI								
Clean and Condition Spa Cover								
Miscellaneous Service								
Miscellaneous Service								

SPA CARE AND MAINTENANCE RECORD

DATE DATE DATE DATE DATE DATE DATE DATE

Drain & Clean Spa								
Clean Filter Cartridge								
Soak Filter Cartridge in Solution								
Test GFCI								
Clean and Condition Spa Cover								
Miscellaneous Service								
Miscellaneous Service								



T W I L I G H T
Series BY MASTER SPAS

Twilight Whirlpool™ is manufactured
by Master Spas, one of the world's
leading spa manufacturers.
6927 Lincoln Parkway
Fort Wayne, IN 46804
800.860.7727 sales@masterspas.com

Master Spas reserves the right to change specifications or features without notice.

Master Spas is a manufacturer of spas and related products and we stand behind every product we produce pursuant to those representations which are stated in our written limited warranty. your dealer is an independent business person or company and not an employee or agent of Master Spas, Inc. We cannot and do not accept any responsibility or liability for any other representations, statements or contracts made by any dealer beyond the provisions of our written limited warranty.