

tmx

CATALOGUE

Design radiatoren en aluminium handdoekradiatoren



TMX International is een Europese fabrikant en een onbetwistbaar symbool van kwaliteit en stijl in de productie van aluminium handdoekhouders en designradiatoren.

Wij beschikken over alle benodigde certificaten en voldoen aan de Europese productienormen. De hoofdactiviteit van het bedrijf is de productie van designradiatoren voor thuis, op kantoor en grotere locaties - restaurants, hotels, enz. De radiatoren zijn gemaakt van aluminium en speciaal glas, wat hun hoogwaardige kwaliteit garandeert.



Al onze producten hebben 10 jaar garantie.



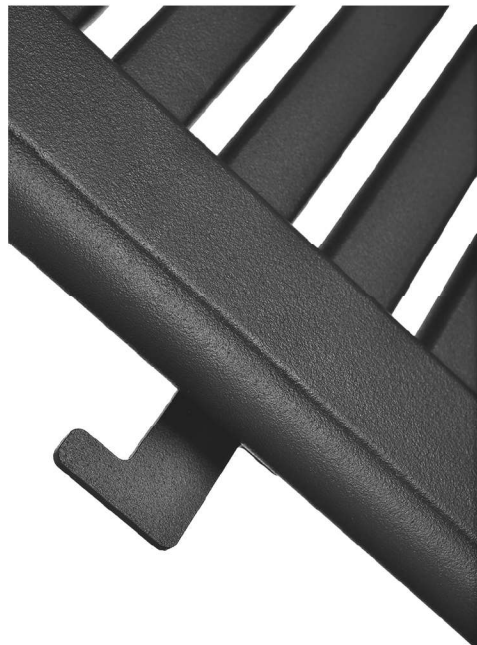
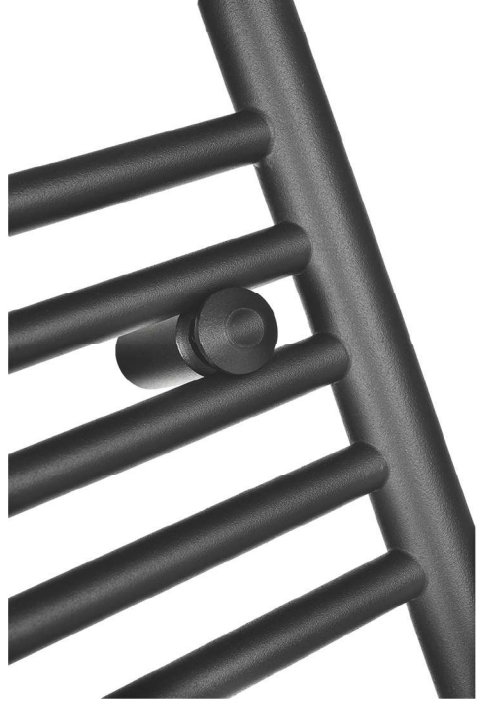

Design

Aluminium

Handdoekradiatoren



Libra



Oval Delux







Fusion

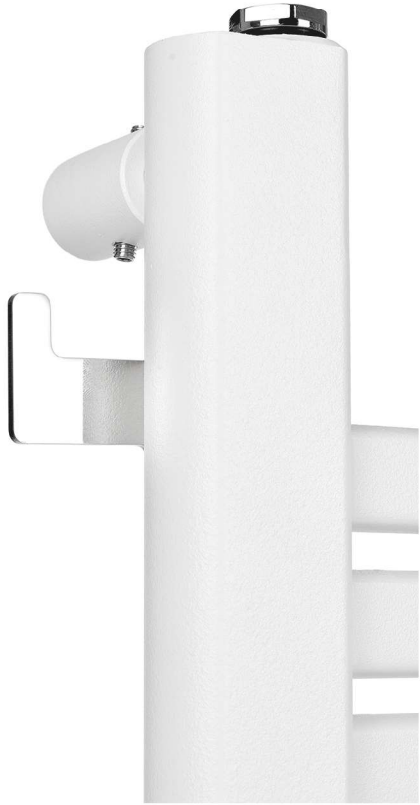



Stilo





OVAL V





Classic

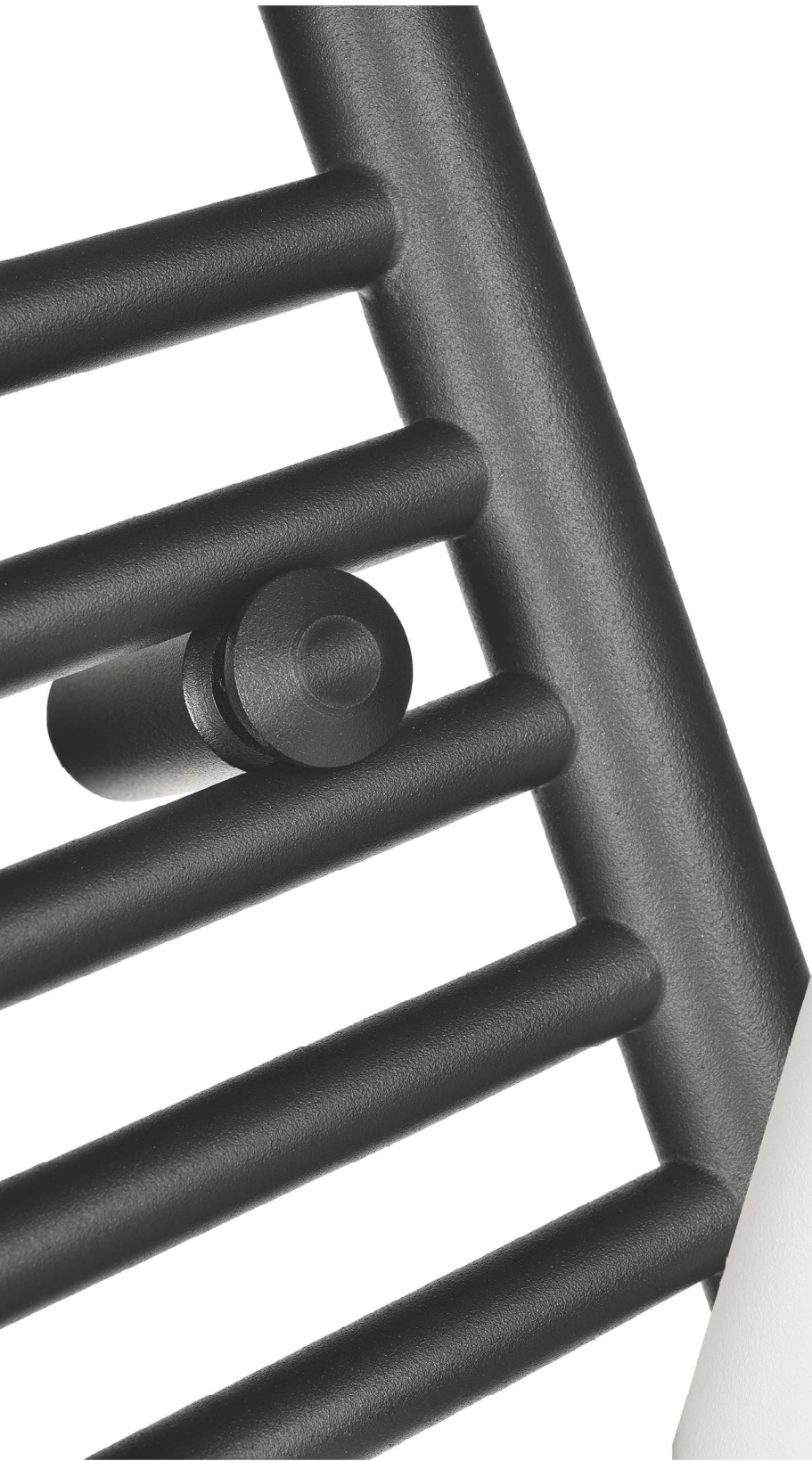



Design Radiatoren

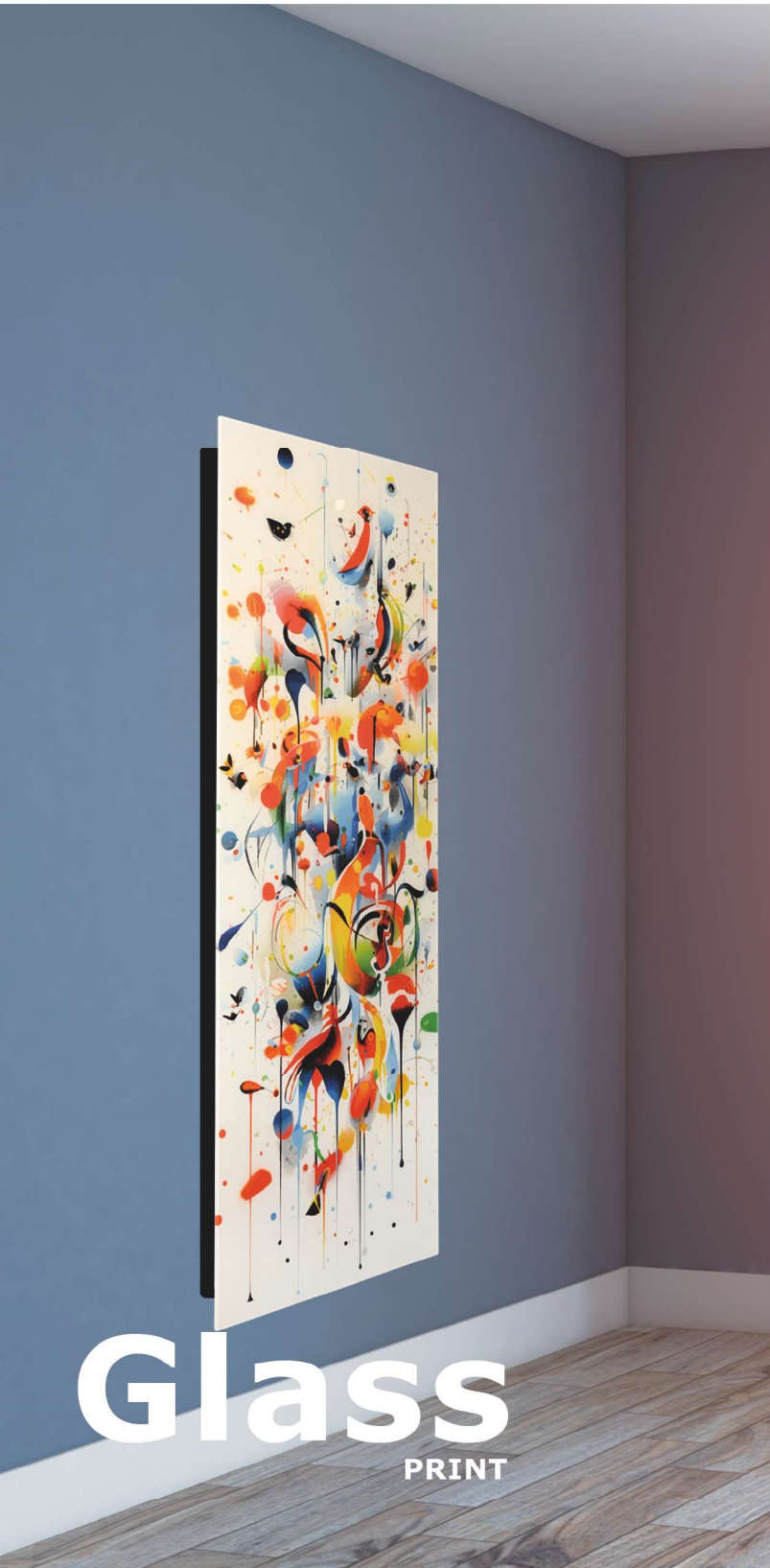

Glass
PRINT



Ceramic
PRINT

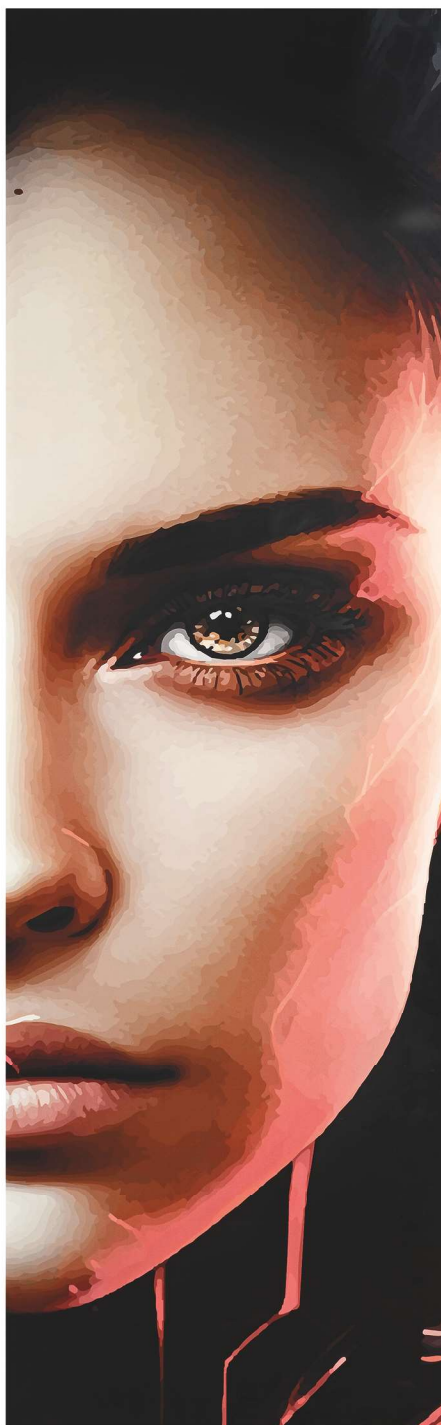
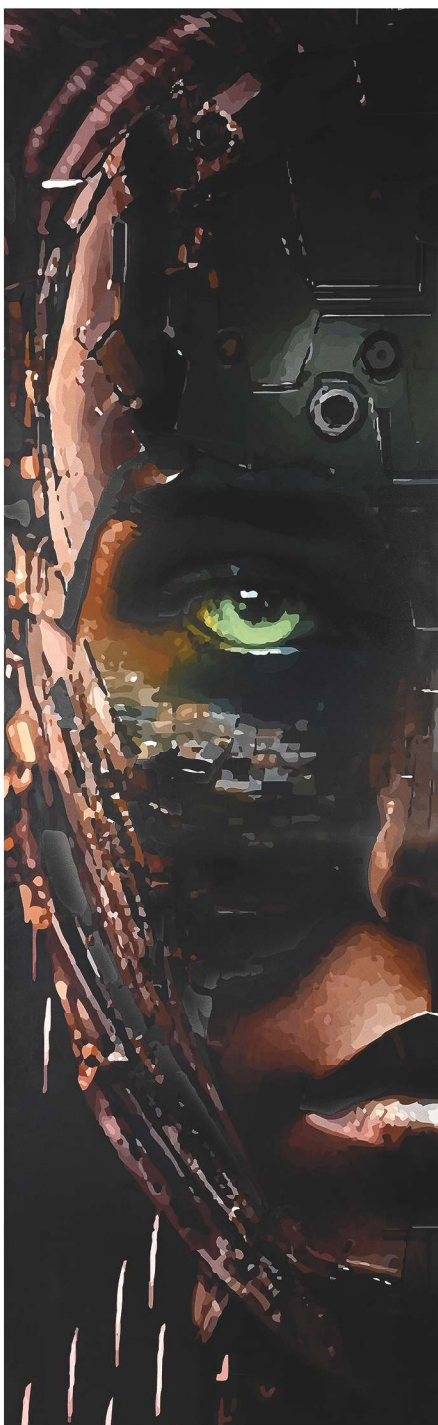

**Thermische verf van
hoge kwaliteit, gedrukt
op keramiek**

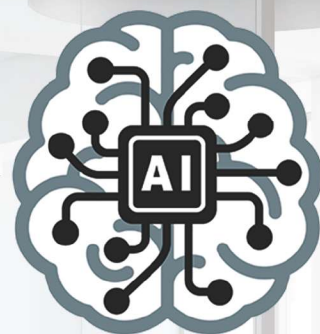

**ARTIFICIAL
INTELLIGENCE**

tmx

ONTWERP JE RADIATOR EN WIJ MAKEN HEM

Doe mee aan de AI-revolutie door met een paar woorden een uniek ontwerp te maken.

We zijn er trots op dat we je de mogelijkheid kunnen bieden om een unieke designradiator te maken voor elke individuele klant, helemaal volgens zijn idee!

Stuur ons een beschrijving van je idee en wij nemen contact met je op met een ontwerp dat helemaal op jouw wensen is afgestemd!





Granite

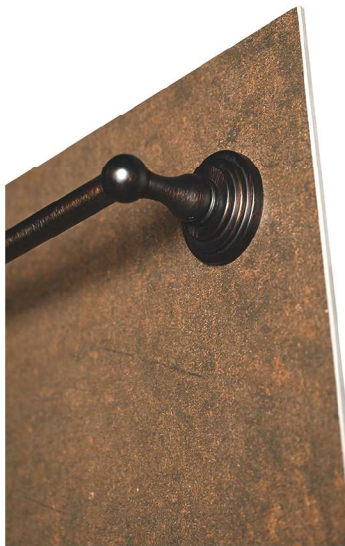





Technische Kenmerken

Libra

tmx

Hoogte	Breedte	Centrale afstand	Vermogen (W)		Temperatuur exponent	Elektrische kachel	Water cap.	Gewicht
			ΔT 50°C	ΔT 30°C				
[mm]	[mm]	[mm]			n	Watt	Litres	Kg
1000	466	400	385	184	1.338	300	2,5	2,6
1320	466	400	482	255	1.249	300	2,8	3.2
1640	466	400	630	334	1.243	600	3,3	4.1

 **Verbindingen**
4x1/2" innerlijk snijwerk

 **15 bar** Getest op 15 bar druk

 **10 bar max.** Werkdruk 10 bar

 **max.** Max. werken temperatuur 90 °C

Elektrische verwarming
De radiator kan worden uitgerust met een elektrisch verwarmingselement

Het pakket bevat:
-3 stuks montagebeugels
-tap
-handmatige ontluchter

Optionele accessoires

Droger Split



Droger Scala



Hanger



Oval Delux

tmx

Hoogte	Breedte	Centrale afstand	Vermogen (W)		Temperatuur exponent	Elektrische kachel	Water cap.	Gewicht
			ΔT 50°C	ΔT 30°C				
[mm]	[mm]	[mm]			n	Watt	Litres	Kg
1000	466	400	304	163	1.217	300	2,5	2,6
1320	466	400	445	234	1.258	300	2,8	3.2
1640	466	400	561	294	1.264	600	3,3	4.1



Verbindingen

4x1/2" innerlijk snijwerk



Getest op 15 bar druk



Werkdruk 10 bar



Max. werken temperatuur 90 °C

Elektrische verwarming

De radiator kan worden uitgerust met een elektrisch verwarmingselement

Het pakket bevat:

- 3 stuks montagebeugels
- tap
- handmatige ontluchter

Optionele accessoires

Droger Split



Droger Scala



Hanger

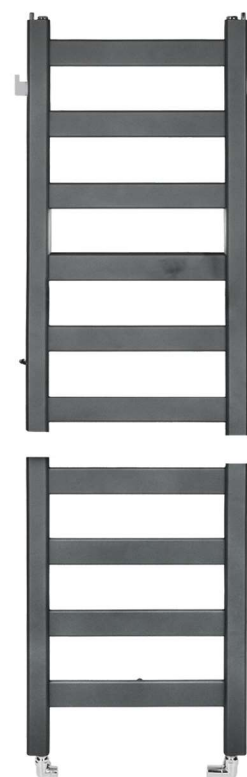

Fusion

tmx

 Hoogte	 Breedte	 Centrale afstand	Vermogen (W)		Temperatuur exponent n	Elektrische kachel Watt	Water cap. Litres	Gewicht Kg
			ΔT 50°C	ΔT 30°C				
[mm]	[mm]	[mm]						
1000	466	400	438	230	1,334	300	2,8	2,8
1500	466	400	550	370	1,289	600	3,2	3,9



Verbindingen

4x1/2" innerlijk snijwerk



Getest op 15 bar druk



Werkdruk 10 bar



Max. werken temperatuur 90 °C

Elektrische verwarming

De radiator kan worden uitgerust met een elektrisch verwarmingselement

Het pakket bevat:

- 3 stuks montagebeugels
- tap
- handmatige ontluchter

Optionele accessoires

Droger Split



Droger Scala





Hanger



Stilo

tmx

 Hoogte	 Breedte	 Centrale afstand	Vermogen (W)		Temperatuur exponent n	Elektrische kachel Watt	Water cap. Litres	Gewicht Kg
			ΔT 50°C	ΔT 30°C				
[mm]	[mm]	[mm]						
1800	170	50	355	179	1.863	300	2,6	4.6
1800	530	1680	1065	537	1.723	600	7.8	14.2



Verbindingen

4x1/2" innerlijk snijwerk



Getest op 15 bar druk



Werkdruk 10 bar



Max. werken temperatuur 90 °C

Elektrische verwarming

De radiator kan worden uitgerust met een elektrisch verwarmingselement

Het pakket bevat:

- 3 stuks montagebeugels
- tap
- handmatige ontluucher

Optionele accessoires

Droger Scala



Oval V

tmx

 Hoogte	 Breedte	 Centrale afstand	Vermogen (W)		Temperatuur exponent	Elektrische kachel	Water cap.	Gewicht
			ΔT 50°C	ΔT 30°C				
[mm]	[mm]	[mm]						
1750	200	290	384	198	1.242	N/A	2.1	3.2



Verbindingen

4x1/2" innerlijk snijwerk



Getest op 15 bar druk



Werkdruk 10 bar



Max. werken temperatuur 90 °C

Het pakket bevat:

- 3 stuks montagebeugels
- tap
- handmatige ontluchter

Optionele accessoires

Droger Scala



Hanger

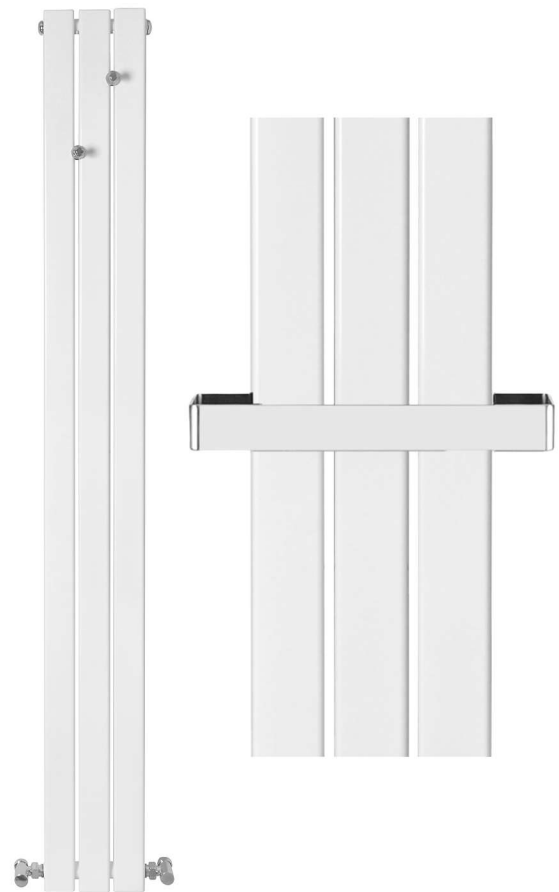

Classic

tmx

Hoogte	Breedte	Centrale afstand	Vermogen (W)		Temperatuur exponent	Elektrische kachel	Water cap.	Gewicht
			ΔT 50°C	ΔT 30°C	n	Watt	Litres	Kg
700	382	350	360	193	1.223	300	2.1	2.2
900	432	400	512	254	1.261	300	2.6	2.9
1200	432	400	690	344	1.243	600	3.7	4
1400	432	400	934	463	1.262	600	4.6	4.6



Verbindingen

4x1/2" innerlijk snijwerk



Getest op 15 bar druk



Werkdruk 10 bar



Max. werken temperatuur 90 °C

Elektrische verwarming

De radiator kan worden uitgerust met een elektrisch verwarmingselement

Het pakket bevat:

- 3 stuks montagebeugels
- tap
- handmatige ontlufter



Glass

tmx

Hoogte [mm]	Breedte [mm]	Centrale afstand [mm]	Vermogen (W)		Temperatuur exponent n	Elektrische kachel Watt	Water cap. Litres	Gewicht Kg
			$\Delta T 50$ C°	$\Delta T 30$ C°				
1200	530	400	391	181	1.214	300	3.2	19.2
1500	530	400	668	383	1.182	600	6.7	22.9
1800	630	500	844	432	1.243	600	7.2	26.3
2000	730	600	1020	500	1.223	600	7.5	29
2000	930	800	1222	590	1.262	600	8.9	35.6



Verbindingen
4x1/2" innerlijk
snijwerk



Getest op 15 bar
druk



Werkdruk 10 bar



Max. werk
temperatuur 90 °C

**tmx biedt aangepaste
maten op designradiatoren
voor elke klantbehoefte**

Elektrische kachel

Elke radiator van tmx kan
worden uitgerust met een el-
ektrisch verwarmingsele-
ment



Het pakket bevat

- 3st. montagebeugels
- tap
- handmatige ontluucher



Granite

tmx

 Hoogte	 Breedte	 Centrale afstand	Vermogen (W)		Temperatuur exponent n	Elektrische kachel Watt	Water cap. Litres	Gewicht Kg
			ΔT 50 C°	ΔT 30 C°				
[mm]	[mm]	[mm]						
1200	530	400	391	184	1.214	300	3.2	19.2
1500	530	400	668	383	1.182	600	6.7	22.9
1800	630	500	844	432	1.243	600	7.2	26.3
2000	730	600	1020	500	1.223	600	7.5	29
2000	930	800	1222	590	1.262	600	8.9	35.6



Verbindingen
4x1/2" innerlijk
snijwerk



Getest op 15 bar
druk



Werkdruk 10 bar



Max. werk
temperatuur 90 °C

**tmx biedt aangepaste
maten op designradiatoren
voor elke klantbehoefte**

Elektrische kachel

Elke radiator van tmx kan worden uitgerust met een elektrisch verwarmingselement

Het pakket bevat

- 3st. montagebeugels
- tap
- handmatige ontluchter

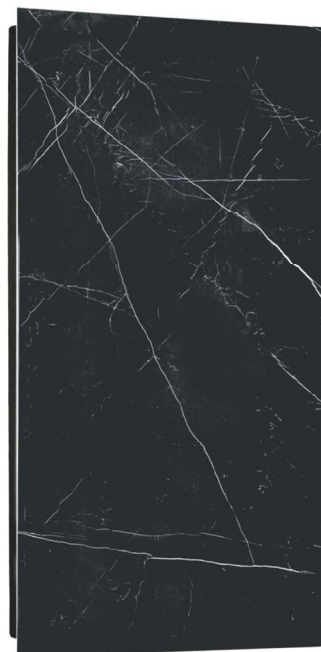

www.tmxgroup.nl