

Alix BACK-TO-WALL TOILET SUITES

K011



Rimless



Extra Height



Short Projection



Soft Close

Standard Seat, White

P-Trap • K011P

S-Trap 90-160 • K011A

S-Trap 160-230 • K011B

Standard Seat, Grey

P-Trap • K011GP

S-Trap 90-160 • K011GA

S-Trap 160-230 • K011GB

Slim Seat

P-Trap • K011P-2

S-Trap 90-160 • K011A-2

S-Trap 160-230 • K011B-2

- Can be installed to comply with Ambulant AS1428.1
- Rimless hygienic flush
- Extra height pan: 450mm
- Short projection from wall for tight spaces
- Concealed pan for easy cleaning
- UF quick release, soft close seat
- Large, easy-push chrome flush buttons
- High quality, R&T flush mechanism
- Top or bottom inlets:
 - Left top inlet
 - Left or right bottom inlet
- Available as P-Trap or S-Trap
- **WELS 4 Star rated, 4.5L/3L (3.3L average flush)**



Standard Seat

Slim Seat

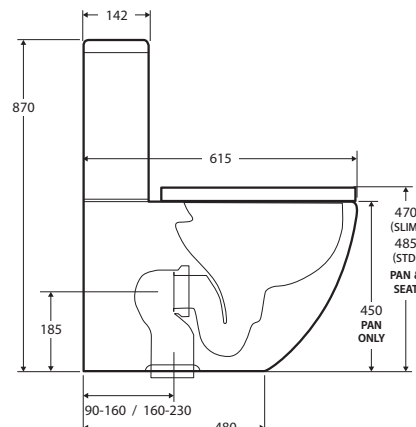
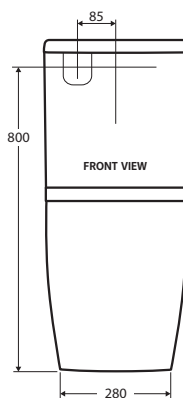
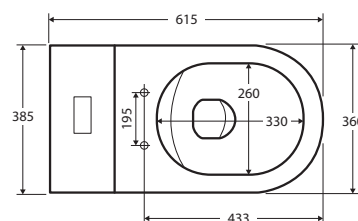
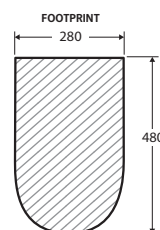



Parts List

Description	Item Code
Pan	K011-P
Cistern	K002-C
Standard White Seat	UF2009W
Standard Grey Seat	UF2009G
Slim Seat	UF5019
Pan Bolts	200150
Cistern Bolts	200154
Inlet Valve	200129
Outlet Valve	200127
Outlet Valve Washer	200828

All installations should be carried out by a qualified tradesman in compliance with the National Plumbing & Drainage Code and any State or Local Authority Regulations, in accordance with AS/NZS 3500 series of standards and AS/NZA 6400. All measurements are in millimetres and are subject to change without notice. For ceramic products, please allow +/- 10 mm tolerance for manufacturing variance. Please refer to fienza.com.au for the latest product specification.

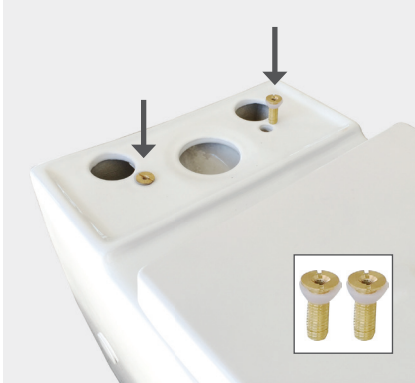
Cistern Installation

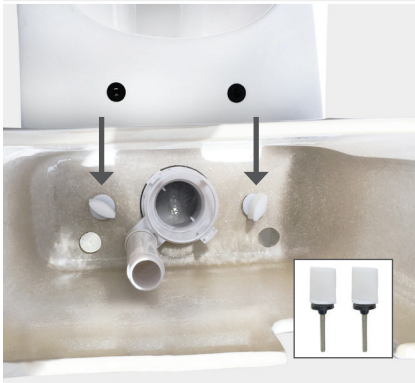
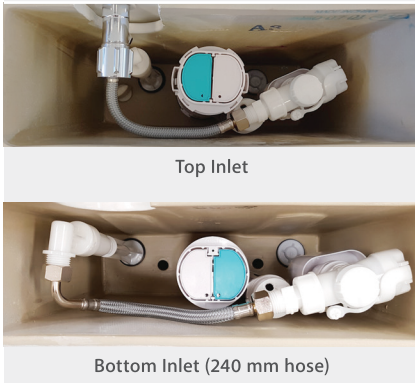
<p>1. Parts required to mount cistern to pan.</p>	<p>2. Attach cistern bolts into pan. Tighten from underneath.</p>	<p>3. Ensure outlet rubber is fitted to cistern.</p>
		
<p>4. Sit cistern onto pan.</p>	<p>5. Use supplied bolts to fasten cistern to pan.</p>	<p>6. Attached the supplied flexi hose as pictured to suit your inlet setup.</p>
		

S-Trap Installation

1. The S-pipe should be put into position and cut to suit your set out, then attached to the wall using the thread bolt and plate provided.
2. Now push the pan hard into position to ensure the ceramic outlet is pushed into the S-pipe by approx 50 mm. This is so the rubber inside the S-pipe gets a good seal to stop water leaking.

PLEASE DO NOT SILICONE PAN TO FLOOR UNTIL TOILET HAS BEEN CHECKED FOR LEAKS.

Seat Installation

1. Open the box and check all the components.
2. Insert the expansion fittings (5) into the seat bolt holes in the pan.
3. Assemble washers (4), hinge fixings (3) and bolts (2) as shown in the diagram. Leave loosely attached.
4. Align the hinge housing of the seat with the hinge fixings and adjust the seat to desired position.
5. Remove the seat by depressing the chrome release buttons and lifting upwards.
6. Tighten the bolts with a Phillips head screwdriver ensuring that the expansion fittings are secure. Put the decorative cap in the position then attach the seat on the hinges.

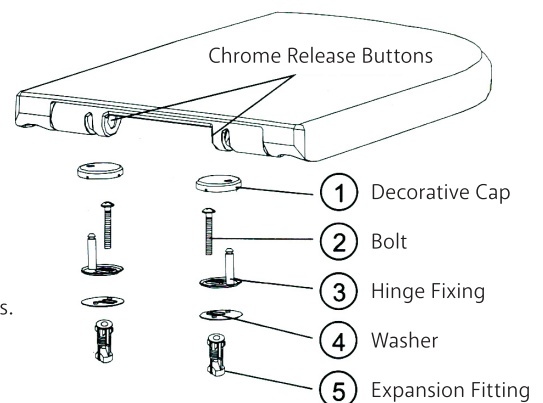

All installations should be carried out by a qualified tradesman in compliance with the National Plumbing & Drainage Code and any State or Local Authority Regulations, in accordance with AS/NZS 3500 series of standards and AS/NZA 6400. All measurements are in millimetres and are subject to change without notice. For ceramic products, please allow +/- 10 mm tolerance for manufacturing variance. Please refer to fienza.com.au for the latest product specification.

Inlet Valve Service

1. Water Level Adjustment

Turn screw to raise/lower the float

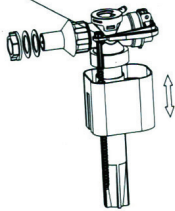

2. Cleaning the Diaphragm

It is possible for dirt/debris to prevent the valve shutting off. To remedy this the diaphragm may be cleaned as follows:

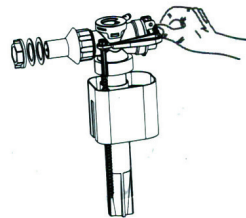

1. Unclip the float arm from the adjustment screw
2. Twist the plastic top-assembly firmly anti-clockwise and remove it from the valve body
3. Inspect both rubber diaphragm and valve seat
4. Rinse under running water to remove debris
5. Re-assemble in reverse order



WARNING

Do not use chlorine/chemical sanitisers in the cistern tank. Such use may result in damage to tank components and will void the product warranty.

Outlet Valve Service

Removal

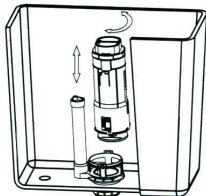

Valve may be removed for service - twist to unlock

Assembly

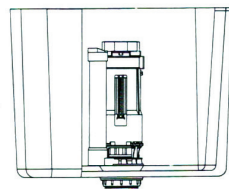

Hoses are not shown on the diagram

Push Button Rod Settings

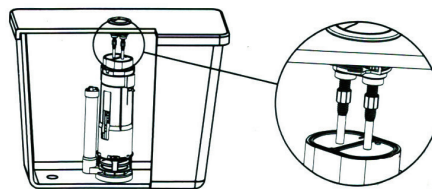

Button rods must be just clear of the valve pads

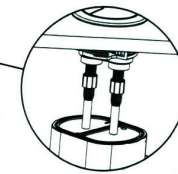

Button rods can be adjusted by screwing up or down

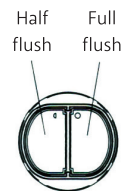

Ensure that buttons match valve pads

Half Flush Adjustment

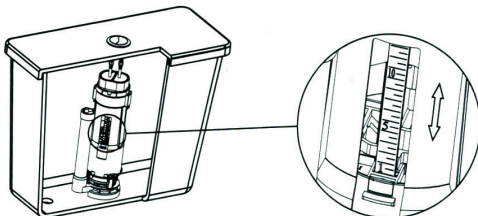

Half flush volume can be adjusted by moving the side float up or down.
Moving the float DOWN increases the flush.
Moving the float UP decreases the flush.

Full Flush Adjustment

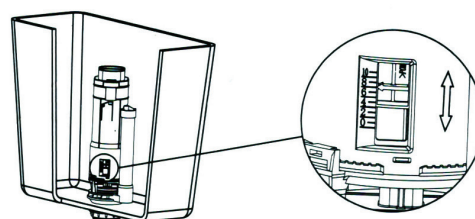

Full flush volume can be adjusted by changing the residual water level in the cistern.
Move the adjuster DOWN to increase the volume.
Move the adjuster UP to decrease the volume.

All installations should be carried out by a qualified tradesman in compliance with the National Plumbing & Drainage Code and any State or Local Authority Regulations, in accordance with AS/NZS 3500 series of standards and AS/NZA 6400. All measurements are in millimetres and are subject to change without notice. For ceramic products, please allow +/- 10 mm tolerance for manufacturing variance. Please refer to fienza.com.au for the latest product specification.

Warranties

Residential Warranty Periods

Applies to domestic uses and applications of Fienza® products, such as private dwellings and retirement villages.

TOILETS*	
Range	Residential
Vitreous China	5 years replacement parts or product, 1 year labour
R&T Cisterns (Tanks & Frames)	5 years replacement parts or product, 1 year labour
R&T Cisterns (Valves)	3 years replacement parts or product, 1 year labour
Accessories & Spare Parts	1 year replacement parts or product

*Excludes parts subject to wear and tear such as rubber seals. Labour is not included unless otherwise specified.

Commercial Warranty Periods

Applies to commercial uses and applications of Fienza® products, including, but not limited to: commercial food premises such as restaurants; commercial accommodation such as hotels; hospitals and healthcare facilities; public amenities; and industrial, laboratory and manufacturing facilities.

TOILETS*	
Range	Commercial
Vitreous China	3 years replacement parts or product, 1 year labour
R&T Cisterns (Tanks & Frames)	5 years replacement parts or product, 1 year labour
R&T Cisterns (Valves)	1 year replacement parts or product, 1 year labour
Accessories & Spare Parts	1 year replacement parts or product

*Excludes parts subject to wear and tear such as rubber seals. Labour is not included unless otherwise specified.

For warranty support, please contact Fienza

fienza®

2 Bailey Court, Brendale QLD 4500

PO Box 5381, Brendale QLD 4500

P 07 3490 6700 F 07 3490 6719

E help@fienza.com.au ABN 76 136 411 311

Warranty Conditions

- Installation has been carried out by a licensed plumber in accordance with the plumbing code of Australia.
- All maintenance and adjustments to the product after the installation have been carried out by a licensed plumber.
- No additives have been introduced into the cistern tank.
- Only mild household detergents and soft (non-abrasive) cloth has been used to clean the product.
- All goods of substandard quality manufacture (excluding imperfections permitted within AS1976 - Vitreous China used in Sanitary Applications) will be credited or replaced by Fienza when advised within the warranty period, subject to prior inspection and agreement.
- Proof of purchase is required for warranty claims.

Warranty Limitations

To the extent permitted under the Trade Practices Act and other relevant legislation, Fienza's liability is limited to:

- The cost of replacing the goods, or
- The cost of obtaining equivalent goods, or
- The cost of having the goods repaired
- Fienza is not responsible for any lack of operation or performance of goods (or any loss or damage) where goods are used or adapted for a with other goods not supplied by Fienza.
- It is the responsibility of the customer and installer before installation to ensure are correct and free of obvious visible faults.
- Fienza is not responsible for the labour and rectification costs incurred in the above circumstance.

Conditions for On-Site Warranty Service Calls

Fienza will charge a service fee for each visit to an installation by its technician where it is determined that the fault is due to poorly executed or unlicensed installation work or where the product is not a genuine Fienza product or where the product is outside the warranty period. This may be paid in advance by credit card over the phone to a Fienza technician attending the site and will be refunded if the Fienza product is found to be at fault.

Cleaning & Operation

- The toilet seat may be removed for cleaning - depress the chrome hinge release buttons and lift up.
- Clean only with a soft cloth or sponge using warm water and mild soap or detergent. Do not use any abrasive cleaning materials.
- Do not use any solvents or corrosive liquids.
- Note that use of clip-on deodorisers will affect flushing performance on rimless suites.

All installations should be carried out by a qualified tradesman in compliance with the National Plumbing & Drainage Code and any State or Local Authority Regulations, in accordance with AS/NZS 3500 series of standards and AS/NZS 6400. All measurements are in millimetres and are subject to change without notice. For ceramic products, please allow +/- 10 mm tolerance for manufacturing variance. Please refer to fienza.com.au for the latest product specification.