



Order No. **X-PLF4214-XS**
Model No. **PLF4214-XS (Slim Linear PLF 42 inch)**

Notes:

Section 10309 - Manufactured Electric Fireplaces

PART 1 GENERAL

1.1 SECTION INCLUDES

- A. Manufactured electric fireplaces.
- B. Accessories.

1.2 RELATED SECTIONS

- A. Section 06100 - Rough Carpentry: Wood framed rough opening and enclosure.

1.3 REFERENCES

- A. UL - 2021
- B. CSA - C22.2 No. 46

1.4 SUBMITTALS

- A. Submit under provisions of Section 01300.
- B. Product Data: Manufacturer's data sheets on each product to be used, including:
 - 1. Preparation instructions and recommendations.
 - 2. Storage and handling requirements and recommendations.
 - 3. Installation methods.
- C. Manufacturer's Certificates: Certify products meet or exceed specified requirements.
- D. Manufacturer's warranty.

1.5 DELIVERY, STORAGE, AND HANDLING

- A. Store products in manufacturer's unopened packaging until ready for installation.
- B. Protect materials from exposure to moisture. Do not deliver until after wet work is complete and dry.

1.6 WARRANTY

- A. Provide the manufacturer's 2-year limited warranty on labor and electrical components.

PART 2 PRODUCTS

2.1 ACCEPTABLE MANUFACTURERS

- A. Pre-fabricated Electric Fireplace:
 - 1. Base: Dimplex Electric Fireplace
Glen Dimplex Americas
1367 Industrial Road
Cambridge ON N3H 4W3
1-888-346-7539
www.dimplex.com
 - 2. Substitutions not permitted
 - 3. Requests for substitutions will be considered in accordance with provisions of Section 01600.



Order No.	X-PLF4214-XS
Model No.	PLF4214-XS (Slim Linear PLF 42 inch)
Notes:	

Section 10309 - Manufactured Electric Fireplaces

2.2 ELECTRIC FIREPLACES

A. General:

1. Provide all components and accessories required for a complete, functional unit.
2. cULus listed, file E71416

B. Pre-fabricated Electric Fireplace:

1. Base Product:
 - a) Dimplex Slim Linear Electric Fireplace
 - b) Material Number: X-PLF4214-XS
 - c) Model Number: PLF4214-XS
 - d) Regulatory model number: 6910470200
2. Description: Realistic 42" linear electric fireplace
3. Dimensions (with included trim):
 - a) Width: 43-1/4" / 109.8 cm
 - b) Height: 19-1/2" / 49.7 cm
 - c) Depth: 3-3/4" / 9.7 cm
4. Framing Dimensions:
 - a) Width: 42-1/2" / 108.0 cm
 - b) Height: 19-1/8" / 48.6 cm
 - c) Depth*: 4" / 10.2 cm (*Includes 1/2" drywall)
5. Electrical:
 - a) Volts: 120 V
 - b) Watts: 1500 W
 - c) BTUs: 5118
 - d) Amps: 12.5
6. Venting: Non-venting
7. Operation: Flame only, flame and heat
8. Heating: Louver-less, fan-forced circulation
9. Liner: Steel
10. Standard features:
 - a) Flame/media bed on/off, range of color themes
 - b) Acrylic crystal ember bed with sparkle effect
 - c) LED flame technology
 - d) Pre-set and custom color effects
 - e) On-demand heater
 - f) Built-in hidden touch controls



Order No.	X-PLF4214-XS
Model No.	PLF4214-XS (Slim Linear PLF 42 inch)
Notes:	

Section 10309 - Manufactured Electric Fireplaces

- g) Built-in Timer - Set for up to 8 hours
 - h) Seamless installation and edge to edge glass
 - i) Integrated self-diagnostics reduce trouble shooting time and improve service and lead times for components.
11. Control options:
- a) Flame Connect mobile app
 - b) Multi-function remote control
 - c) Built-in hidden controls (Standby, heat on/off, thermostat, brightness, flame theme)
12. Optional Accessories:
- a) Plug Kit - X-PLFXSPLUG

PART 3 EXECUTION

3.1 INSPECTION

- A. Do not begin installation until substrates have been properly prepared.
- B. If substrate preparation is the responsibility of another installer, notify Architect of unsatisfactory preparation before proceeding.
- C. Verify proper power supply and fuel source are available.

3.2 PREPARATION

- A. Clean surfaces thoroughly prior to installation.
- B. Prepare surfaces using the methods recommended by the manufacturer for achieving the best result for the substrate under the project conditions.

3.3 INSTALLATION

- A. Install in accordance with manufacturer's instructions and requirements of authorities having jurisdiction.
- B. Use manufacturer's guidelines for minimum clearances to combustibles, walls, and finishes.
- C. Anchor all components firmly in position for long life under hard use.
- D. Upon completion of installation, visually inspect all exposed surfaces. Touch up scratches and abrasions with touch up paint recommended by the manufacturer; make imperfections invisible to the unaided eye from a distance of 5 feet (1.5 m).
- E. To use the mobile app, install where a WiFi connection is available.

3.4 PROTECTION

- A. Protect installed products until completion of project.
- B. Touch-up, repair or replace damaged products before Substantial Completion.

END OF SECTION



Order No. **X-PLF4214-XS**
 Model No. **PLF4214-XS (Slim Linear PLF 42 inch)**
 Notes:

Product Dimensions:

Model	A Viewing Dimensions	B Dimensions With Trim
PLF3614-XS	33-1/4" 84.5 cm	37-1/4" 94.6 cm
PLF4214-XS	39-1/4" 99.7 cm	43-1/4" 109.8 cm
PLF5014-XS	47-1/4" 120.1 cm	51-1/4" 130.1 cm
PLF6014-XS	57-1/4" 145.5 cm	61-1/4" 155.5 cm

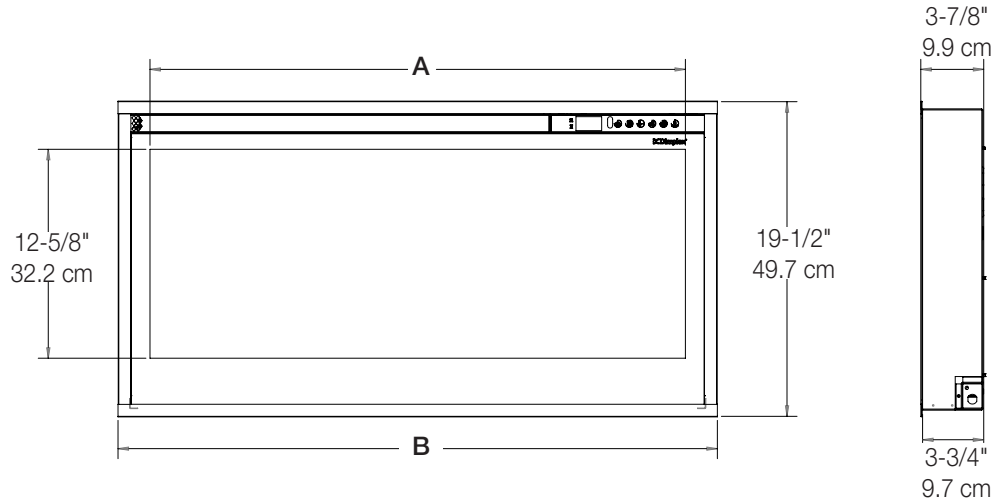

Recessed Installation:

! NOTE: The pre-installed trim helps conceal imperfections in the drywall edges against the fireplace and gives the fireplace a finished appearance.

1. Prepare a framed opening, following the dimensions shown in the table below (Figure 1).

Framing Dimensions

Model	Width	Height	Depth* (minimum)
	A	B	C
PLF3614-XS	36-1/2" 92.7 cm	19-1/8" 48.6 cm	4" 10.2 cm *Includes 1/2" drywall
PLF4214-XS	42-1/2" 108.0 cm		
PLF5014-XS	50-1/2" 128.3 cm		
PLF6014-XS	60-1/2" 153.7 cm		

Figure 1

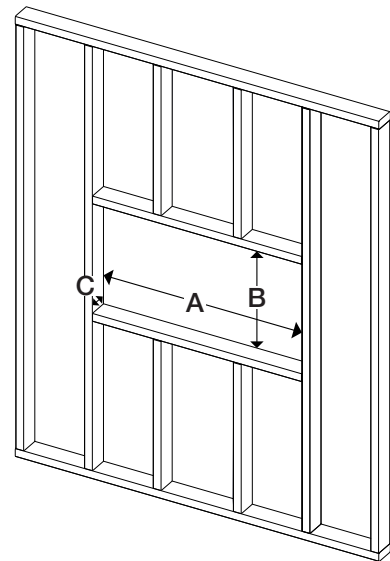

! CAUTION: This fireplace is NOT load-bearing. Ensure the opening for the fireplace is framed in such a way that the weight of the building materials will not create pressure on the top of the fireplace.

! NOTE: Wiring is performed at the bottom right back corner of the firebox. (Figure 2) Plan the framing to allow routing the power cable to this location.

Figure 2

