



# Owner's Manual

## Models

- XHD28L - 6913840259
- XHD28G - 6913840559
- XHD26L - 6913830259
- XHD26G - 6913830559
- XHD23L - 6913820259
- XHD23G - 6913820559
- XHD33L - 6910090259
- XHD33G - 6910090559



## We value your feedback!

Your input helps to create even better products and experiences.

Share the warmth and leave a review.

[dimplex.com/sharethewarmth](https://www.dimplex.com/sharethewarmth)

 [YouTube/Dimplex](https://www.youtube.com/Dimplex) 











### IMPORTANT SAFETY INFORMATION:

Read this manual first before attempting to install or use this electric heater. Always comply with the warnings and safety instructions contained in this manual to prevent personal injury or property damage.



To view the full line of Dimplex products, visit [www.dimplex.com](https://www.dimplex.com)



# Table of Contents

 Welcome .....	3
 IMPORTANT INSTRUCTIONS .....	4
 Specifications .....	6
 Installation .....	7
 Operation.....	10
 Maintenance.....	14
 Technical Support.....	14
 Electrical .....	15
 Warranty.....	16

Conventions used in this manual:

-  **NOTE:** Procedures and techniques considered important enough to emphasize.
-  **CAUTION:** Procedures and techniques which, if not carefully followed, will result in damage to the equipment.
-  **WARNING:** Procedures and techniques which, if not carefully followed, will expose the user to the risk of fire, serious injury, or death.

## Welcome

Thank you for purchasing a Dimplex Electric Fireplace. Please use our convenient online registration page to record your model and serial numbers for future reference at:

***[www.dimplex.com/register](http://www.dimplex.com/register)***

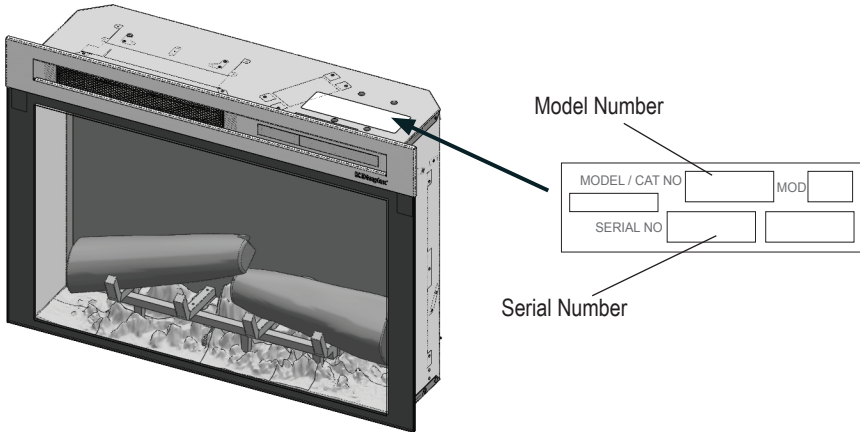

**⚠ CAUTION:** Read all instructions and warnings carefully before starting installation. Failure to follow these instructions may result in a possible electric shock or fire hazard and will void the warranty.



**NO NEED TO RETURN TO THE STORE**

Questions with operation or assembly? Require Parts Information?  
Product Under Manufacturer's Warranty?

Contact us at:  **[www.dimplex.com/support](http://www.dimplex.com/support)**

For Troubleshooting and Technical Support

OR  **Toll-Free 1-888-346-7539**

*In order to better serve you, please have your model and serial numbers ready or register your product online before calling (see above).*



# IMPORTANT INSTRUCTIONS

## Basic Precautions

When using any electrical appliance, basic precautions should always be followed to reduce the risk of fire, electric shock, and injury to persons. These precautions include:

- ① Read all instructions before using the electric fireplace.
- ② Extreme caution is necessary when the firebox is used by or near children or invalids and whenever the firebox is left operating and unattended.
- ③ Always turn off the fireplace when it is not in use.
- ④ Do not operate the fireplace with a damaged power cord or plug or after the fireplace malfunctions, has been dropped, or damaged in any manner. Contact Technical Service at 1-888-346-7539.
- ⑤ Do not use this firebox outdoors.
- ⑥ This fireplace is not intended for use in bathrooms, laundry areas, or similar indoor locations. Never locate the fireplace where it may fall into a bathtub or other water container.
- ⑦ Do not run power cord under carpeting. Do not cover cord with throw rugs, runners, or similar coverings. Do not route cord under furniture or appliances. Arrange cord away from traffic area and where it will not be tripped over.
- ⑧ To disconnect the fireplace, turn the controls to OFF and remove the power cord plug from the outlet.
- ⑨ Connect the power cord to a properly grounded outlet only.
- ⑩ Do not insert or allow foreign objects to enter any ventilation or exhaust opening as this may cause an electric shock or fire, or damage the firebox. To prevent a possible fire, do not block air intakes or exhaust in any manner. Do not use the fireplace on soft surfaces, like a bed, where openings may become blocked.
- ⑪ All electrical heaters have hot and arcing or sparking parts inside. Do not use it in areas where gasoline, paint, or flammable liquids are used or stored.
- ⑫ Use this fireplace only as described in this manual. Any other use not recommended by the manufacturer may cause fire, electric shock, or injury to persons.
- ⑬ Always plug the fireplace directly into a wall outlet/receptacle. Never use the fireplace with an extension cord or relocatable power tap (outlet/power strip).
- ⑭ Do not burn wood or other materials in this fireplace.
- ⑮ When transporting or storing the fireplace, keep it in a dry place, free from excessive vibration, and store to avoid damage.



## SAVE THESE INSTRUCTIONS



# IMPORTANT INSTRUCTIONS

**! NOTE:** Changes or modifications not expressly approved by the party responsible for compliance could void user's authority to operate the equipment.

## Special Precautions

**⚠ CAUTION:** Do not open the unit. There is a risk of electric shock. There are no user-serviceable parts inside.

**⚠ CAUTION:** Always use a qualified technician or service agency to repair the built-in electric fireplace.

**⚠ WARNING:** Remote control contains a small battery. Keep away from children. If swallowed, seek medical attention immediately.

**⚠ WARNING:** Do not install battery backwards, charge, put in fire or mix with used or other battery types as it may explode or leak causing injury.

**⚠ DANGER:** High temperatures may be generated under certain abnormal conditions. Do not partially or fully cover or obstruct the front of the fireplace.

## FCC Compliance

**⚠ CAUTION:** This unit has been tested and found to comply with the limits for Class B digital device, pursuant to part 15 of the FCC Rules. These limits are designed to provide reasonable protection against harmful interference in a residential installation. This unit generates, uses and can radiate radio frequency energy and, if not installed and used in accordance with the instructions, may cause harmful interference to radio or television reception, which can be determined by turning the unit OFF and ON, the user is encouraged to try to correct the interference by one or more of the following measures:

- Reorient or relocate the receiving antenna.
- Increase the separation between the unit and the receiver.
- Connect the unit into an outlet on a circuit different from that to which the receiver is connected.
- Consult the dealer or an experienced radio/TV technician for help.

This unit complies with Part 15 of the FCC Rules. Operation is subject to the following two conditions: (1) This unit may not cause harmful interference, and (2) this unit must accept any interference received, including interference that may cause undesired operation.

**⚠ FCC CAUTION:** Any changes or modifications not expressly approved by the party responsible for compliance could void the user's authority to operate this equipment.



SA1965A

**CAUTION  
RISK OF ELECTRIC SHOCK  
DO NOT OPEN  
NO USER-SERVICEABLE PARTS INSIDE**



## Specifications

The Dimplex Electric Fireplace offers an alternative to a wood or gas fireplace. It can give your existing fireplace new life or transform a cabinet or media center of your own into a stunning focal point.

### Specifications

#### Electrical

Volts: 120 V, 60 Hz

Amps: 12.5 A

Watts: 1465 W

Wiring: Plug-In

Bulb Type: LED

Approvals  certified to meet UL Standards

**!** **NOTE:** A 15 Amp, 120 Volt circuit is required. A dedicated circuit is preferred, but not essential in all cases. A dedicated circuit will be required if, after installation, the circuit breaker trips or the fuse blows on a regular basis when the heater is operating. Additional appliances on the same circuit may exceed the current rating of the circuit breaker.

**⚠** **WARNING:** Electrical outlet wiring must comply with local building codes and other applicable regulations to reduce the risk of fire, electric shock, or injury to persons.

#### Dimensions:

##### Model XHD33

Width: 33-1/8" (841 mm)

Height: 23-1/4" (590 mm)

Depth: 7-1/2" (191 mm)

##### Model XHD28

Width: 27-3/8" (695 mm)

Height: 23-1/2" (597 mm)

Depth: 7-1/2" (191 mm)

##### Model XHD26

Width: 26" (660 mm)

Height: 18-7/8" (479 mm)

Depth: 7-1/2" (191 mm)

##### Model XHD23

Width: 23" (584 mm)

Height: 20-1/2" (520 mm)

Depth: 7-1/2" (191 mm)

#### Weight:

Model XHD33: 38.6 lb (17.5 kg)

Model XHD28: 32 lb (14.5 kg)

Model XHD26: 25 lb (11.3 kg)

Model XHD23: 23 lb (10.4 kg)

#### Operating Temperature Range:

-4° to 104°F (-20° to 40°C)

# Installation

## Placement

1. The Dimplex Electric Fireplace does not require any special venting. Make sure there is clearance for air circulation beneath the unit and at least 1/2" behind it.

**⚠ CAUTION:** Do not install the fireplace directly on carpet or similar surfaces which may restrict air flow.

2. Install the unit in an opening with the following minimum dimensions:

### Model XHD33

- A 31-5/8" (802 mm) wide
- B 22-5/8" (575 mm) high
- C 8" (203 mm) deep

### Model XHD28

- A 27" (686 mm) wide
- B 23-1/8" (587 mm) high
- C 8" (203 mm) deep

### Model XHD26

- A 24-3/8" (619 mm) wide
- B 18-1/2" (470 mm) high
- C 8" (203 mm) deep

### Model XHD23

- A 21-1/2" (548 mm) wide
- B 20" (508 mm) high
- C 8" (203 mm) deep

3. If installing the unit in an existing fireplace opening, seal all drafts and vents with a non-fibrous insulation material to prevent any chimney debris from falling onto the unit. Do not install into an existing fireplace opening that is prone to dampness.

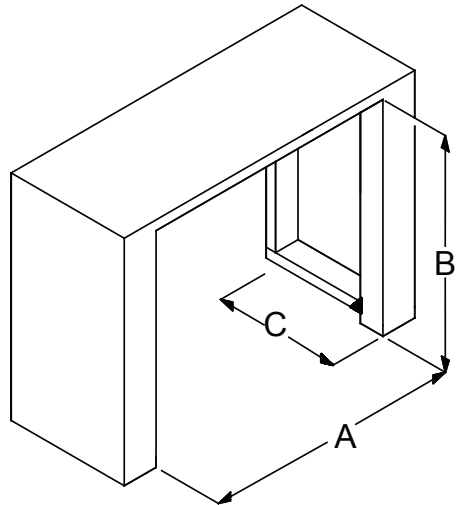

# Installation

## Mounting

1. For media models, carefully disperse the supplied small acrylic crystals in the media tray of the firebox, and arrange large acrylic crystals near the flame panel.
- ! NOTE:** If using media accessory kit XHDDW-KIT (for XHD26G & XHD28G) or XHDDW-KIT33 (for XHD33G), omit supplied crystals, disperse the river rocks in the media tray, and arrange driftwood on top.

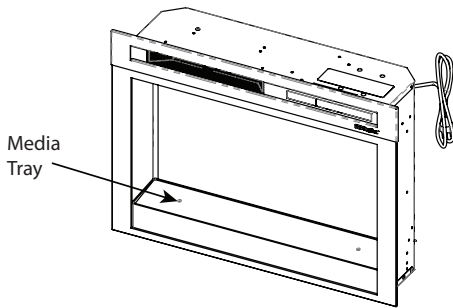

- 2a. If installing into a Dimplex mantel, first check to see if there are holes in the side panels near the top as shown below. If so, align the front of the firebox (without front glass installed) with the front face of the mantel. Install provided screws into the front holes on the inside faces of the firebox. The screw will line up with the hole in the mantel, securing it in place.

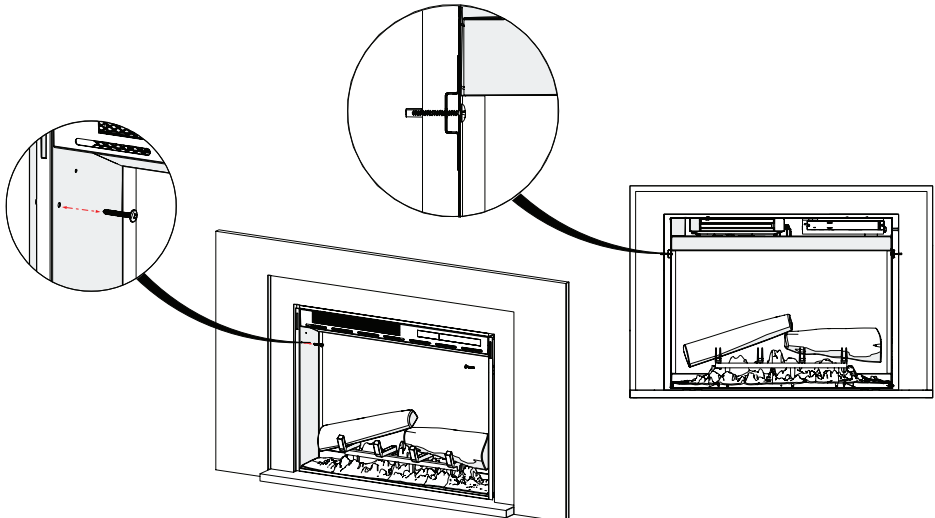
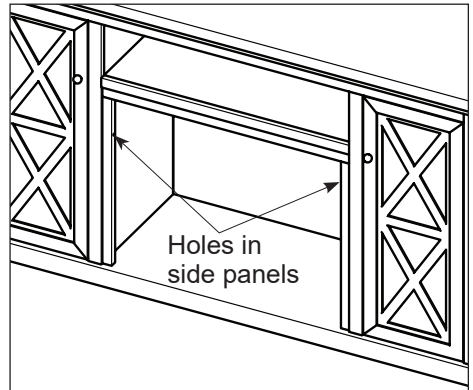



## Installation

If there are no holes on the side panels of the mantel, remove the screw on the back bottom flange most convenient for securing, and use the L-bracket (provided) to secure the firebox to the mantel.

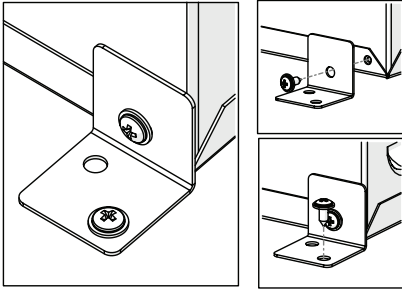

- 2b. If installing into a custom mantel, or into an existing opening, secure the firebox by inserting an appropriate screw through either the front hole, or back hole on the inside face of the firebox, depending on which location is more appropriate for the installation.

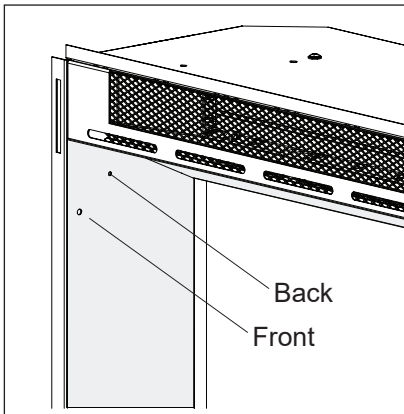

## Grounding Instructions

This product must be grounded. If it should malfunction or breakdown, grounding provides a path of least resistance for electric current to reduce the risk of electric shock. This product is equipped with a cord having an equipment-grounding conductor and a grounding plug.

The plug must be plugged into an appropriate outlet that is properly installed and grounded in accordance with all local codes and ordinances.

This product is for use on a 120V circuit and has a grounding plug that looks like the plug in the following figure. Make sure that the product is connected to an outlet having the same configuration as the plug. No adapter should be used with this product.

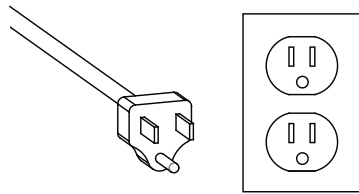

- ⚠ DANGER:** Improper connection of the equipment-grounding conductor can result in a risk of electric shock. Check with a qualified electrician or serviceman if you are in doubt as to whether the product is properly grounded. Do not modify the plug provided with the product – if it will not fit the outlet, have a proper outlet installed by a qualified electrician.

## 🔑 Operation

### Touch Panel and Remote Controls

The manual controls for the Dimplex Electric Fireplace are located on the front panel. Touch the hidden control to the right side of the white line to activate the controls. Select an icon and the digital display will highlight the selection. The touch panel will return to the hidden state after 5 seconds.

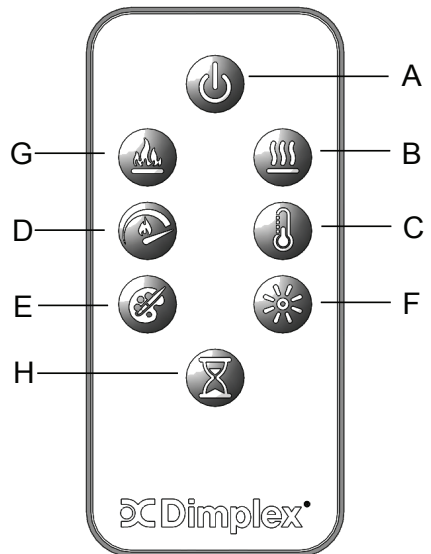
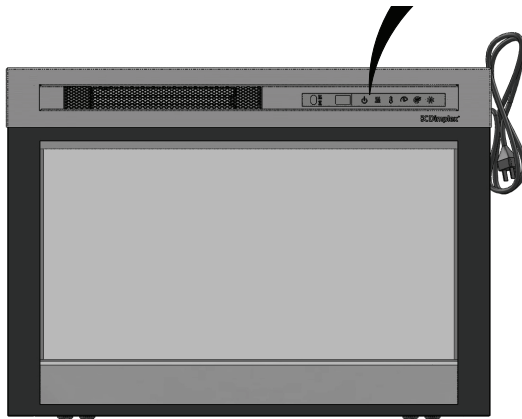

The multi-function IR (infrared) remote control has a range of approximately 30 ft (9 m). To operate, the remote control must be pointed toward the front of the electric fireplace.

#### Indicator Lights



**A****B****C****D****E****F**

**⚠️ WARNING:** The fireplace must be installed properly before use.



## Operation

	Icon	Function	Description
<b>A</b>		<b>Power</b>	Press to turn the unit on or put it in Standby mode. When the unit is turned back on, it will retain the previously used settings (except timer).
<b>B</b>		<b>Heat</b>	<ul style="list-style-type: none"> <li>• <b>Heat On</b> Press to turn heat on (indicated by 1 short beep). Display will show current heater temperature setting and, after 2 seconds, the room temperature. Use the Temperature icon to change the heater temperature setting. <b>NOTE:</b> When the heater is switched on, the heater fan will operate. The heater element may or may not be on depending on the thermostat setting (see "Temperature" section).</li> <li>• <b>Heat Off</b> Press to turn heat off (indicated by 1 short beep). <b>NOTE:</b> After the heater is switched off, the fan will continue on for 2 minutes before turning off.</li> </ul>
<b>C</b>		<b>Temperature</b>	<p>Press multiple times to cycle through the 13 temperature settings: 62°F, 64°F, 66°F, 68°F, 70°F, 72°F, 74°F, 76°F, 78°F, 80°F, 82°F, 84°F, On (17°C, 18°C, 19°C, 20°C, 21°C, 22°C, 23°C, 24°C, 25°C, 26°C, 27°C, 28°C, On [continuous operation]).</p> <p><b>NOTE:</b> To operate the fan without heat, turn the heat on and select a temperature setting that is below the room temperature.</p> <p>Press once to display the set temperature. It will flash for 3 seconds and then display the room temperature.</p>
		<b>Disable Heat</b>	<p>On the touch panel, press the Heat and Temp buttons at the same time and hold for 2 seconds to disable the heater. Press and hold again for 2 seconds to enable the heater.</p> <p>When the heater is disabled, "--" will display when Temp button is pressed. The remainder of the unit's controls will operate in the same fashion.</p>

## Operation

	Icon	Function	Description
		°C / °F Temp	The display can show the temperature reading in either °C or °F. To change the display, press and hold the Temp and Flame Speeds buttons at the same time on the touch panel.
<b>D</b>		<b>Flame Speed</b>	Press multiple times to toggle through flame speeds (minimum, medium, maximum). Display will show current speed number (F1, F2, F3 respectively).
<b>E</b>		<b>Color Themes</b>	<p>Press multiple times to change the media and flame base colors. This feature is active only when the flame effect is on. Display will show theme (t0, t1, t2, etc.)</p> <p>Log unit themes:</p> <ul style="list-style-type: none"> <li>• Theme t0 - no flame</li> <li>• Theme t1 - Natural (flame base off)</li> <li>• Theme t2 - Red highlights</li> <li>• Theme t3 - Orange highlights</li> </ul> <p>Media unit themes:</p> <ul style="list-style-type: none"> <li>• Theme t0 - Midnight mode</li> <li>• Theme t1 - Media white</li> <li>• Theme t2 - Media red/orange</li> <li>• Theme t3 - Media blue</li> <li>• Theme t4 - Media purple</li> <li>• Theme t5 - Media green</li> <li>• Theme to - Prism mode (color cycle)</li> </ul> <p>To choose a custom color, press Brightness icon. Press again to return to Prism Mode.</p>
<b>F</b>		<b>Brightness</b>	Press to change the flame and logs brightness. Display will show b1 (low), b2 (medium), b3 (high).

## Operation

	Icon	Function	Description
<b>G</b>		<b>Flame</b>	<p>Press to turn the flame effect on. Press again to turn the flame effect off.</p> <p><b>NOTE:</b> When the flame effect is off while the heat is on, the heat indicator light will remain illuminated to indicate the fireplace heat function is active.</p>
<b>H</b>		<b>Timer</b>	<p>Press multiple times to change the sleep timer by 0.5 hr from 0.5 hr to 8 hr before turning off. Press again, the remaining time on the timer displays.</p> <p>When the timer is active, the timer indicator light will illuminate.</p>



## Maintenance

### Resetting the Temperature Cutout Switch

Should the heater overheat, an automatic cutout will turn the heater off. It will not come back on without being reset.

To reset the cutout switch, unplug the unit and wait 5 minutes before plugging it back in.

**⚠ CAUTION:** If you need to continuously reset the heater, unplug the unit and call Technical Support at 1-888-346-7539

### General

Inspect the electric firebox regularly, depending upon conditions, and at a minimum yearly intervals. Remove dust and clean with damp cloth as required.

**⚠ CAUTION:** Except for installation and cleaning described in this manual, an authorized service representative should perform any other servicing.

**⚡ WARNING:** Disconnect power by unplugging the power power and allow heater to cool before attempting any maintenance or cleaning to reduce the risk of fire, electric shock, or injury.

### Battery Replacement

**To replace the battery:**

1. Remove the screw on the battery cover using a Philips screwdriver.
2. Depress tab and pull out to release battery compartment on bottom of the remote control.
3. Correctly install one 3 Volt (CR2032 [longer life] or CR2025) battery in the battery compartment
4. Insert the battery compartment and secure with the screw.

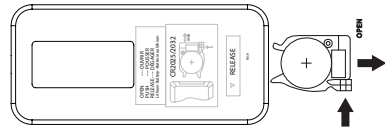

Battery must be recycled or disposed of properly. Check with your Local Authority or Retailer for recycling advice in your area.



## Technical Support

### Support Services

Technical and troubleshooting support, as well as a list of replacement parts can be found on:

[www.dimplex.com/support](http://www.dimplex.com/support)



# Electrical

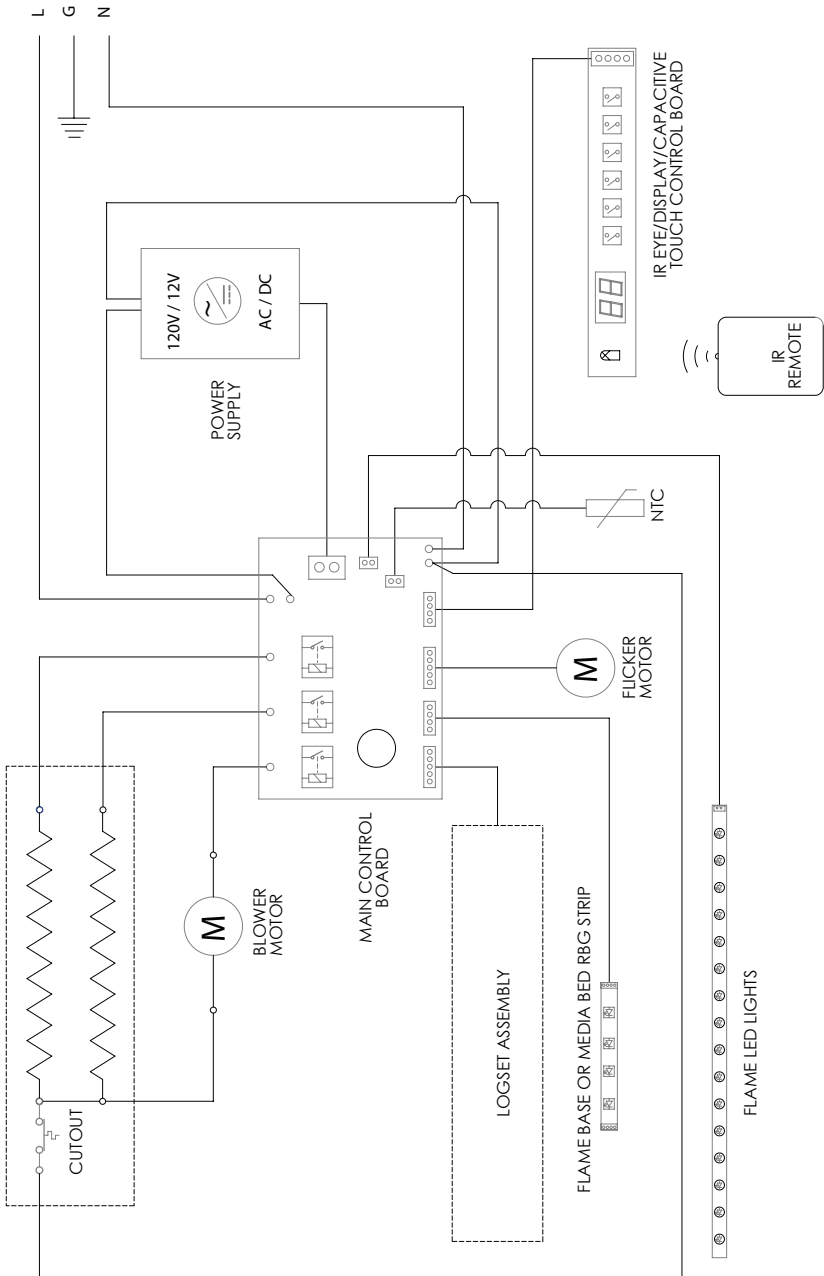



## Warranty

### Two-Year Limited Warranty

#### *Products to which this limited warranty applies*

This limited warranty applies to your newly purchased Dimplex electric fireplace. This limited warranty applies only to purchases made in any province of Canada except for Yukon Territory, Nunavut, or Northwest Territories or in any of the 50 States of the USA (and the District of Columbia) except for Hawaii and Alaska. This limited warranty applies to the original purchaser of the product only and is not transferable.

#### *Products excluded from this limited warranty*

Light bulbs are not covered by this limited warranty and are the sole responsibility of the owner/purchaser. Products purchased in Yukon Territory, Nunavut, Northwest Territories, Hawaii, or Alaska are not covered by this limited warranty. Products purchased in these States, provinces, or territories are sold AS IS without warranty or condition of any kind (including, without limitation, any implied warranties or conditions of merchantability or fitness for a particular purpose) and the entire risk of as to the quality and performance of the products is with the purchaser, and in the event of a defect the purchaser assumes the entire cost of all necessary servicing or repair.

#### *What this limited warranty covers and for how long*

Products, other than fireplace surrounds (mantels) and trims, covered by this limited warranty have been tested and inspected prior to shipment and, subject to the provisions of this warranty, Glen Dimplex Americas Ltd. (herein called Glen Dimplex Americas) warrants such products to be free from defects in material and workmanship for a period of 2 years from the date of the first purchase of such products.

Glen Dimplex Americas fireplace surrounds (mantels) and trims covered by this limited warranty have been tested and inspected prior to shipment and, subject to the

provisions of this warranty, Glen Dimplex Americas warrants such products to be free from defects in material and workmanship for a period of 1 year from the date of first purchase of such products.

The limited 2 year warranty period for products other than fireplace surrounds (mantels) and trims and the limited 1 year warranty period for fireplace surrounds (mantels) and trims also applies to any implied warranties that may exist under applicable law. Some jurisdictions do not allow limitations on how long an implied warranty lasts, so the above limitation may not apply to the purchaser.

#### *What this limited warranty does not cover*

This limited warranty does not apply to products that have been repaired (except by Glen Dimplex Americas or its authorized service representatives) or otherwise altered. This limited warranty does further not apply to defects resulting from misuse, abuse, accident, neglect, incorrect installation, improper maintenance or handling, or operation with an incorrect power source.

#### *What you must do to get service under this limited warranty*

Defects must be brought to the attention of Technical Service at 1-888-346-7539. Please have proof of purchase, catalogue/model and serial numbers available when calling. Limited warranty service requires a proof of purchase of the product.

#### *What Glen Dimplex Americas will do in the event of a defect*

In the event a product or part covered by this limited warranty is proven to be defective in material or workmanship during (i) the 2 year limited warranty period for products other than fireplace surrounds (mantels) and trims, and (ii) the 1 year limited warranty period for surrounds (mantels) and trims, you have the following rights:

- Glen Dimplex Americas will in its sole discretion either repair or replace such defective product or part without charge.





## Warranty

If Glen Dimplex Americas is unable to repair or replace such product or part, or if repair or replacement is not commercially practicable or cannot be timely made, Glen Dimplex Americas may, in lieu of repair or replacement, choose to refund the purchase price for such product or part.

- Limited warranty service will be performed solely by dealers or service agents of Glen Dimplex Americas authorized to provide limited warranty services.
- For products other than surrounds (mantels) and trims, this 2 year limited warranty entitles the purchaser to on-site or in-home warranty services. Accordingly, Glen Dimplex Americas will be responsible for all labour and transportation associated with repairing or replacing the product or part except as follows: (i) charges which may be levied for travel costs incurred to travel to the purchaser's site where the product is located if the purchaser's site is beyond 30 miles (48 km) from the closest service depot of Glen Dimplex Americas dealer or service agent; and (ii) the purchaser is solely responsible for providing clear access to all serviceable parts of the product.
- For surrounds (mantels) and trims, this 1 year limited warranty does not entitle the purchaser to on-site or in-house warranty services. The purchaser is responsible for removal and transportation of the surrounds (mantels) and trims (and any repaired or replacement product or part) to and from the authorized dealer's or service agent's place of business. On-site or in-home services for surrounds (mantels) and trims may be performed at the purchaser's specific request and expense at Glen Dimplex Americas then current rates for such services. Glen Dimplex Americas will not be responsible for, and this limited warranty shall not include, any expense incurred for installation or removal of the surrounds (mantels) or trims or any part thereof (or any replacement product or part)

including, without limitation, all shipping costs and transportation costs to and from the authorized dealer's or service agent's place of business and all labour costs. Such costs shall be the purchaser's responsibility.

*What Glen Dimplex Americas and its dealers and service agents are also not responsible for:*

IN NO EVENT WILL GLEN DIMPLEX AMERICAS, OR ITS DIRECTORS, OFFICERS, OR AGENTS, BE LIABLE TO THE PURCHASER OR ANY THIRD PARTY, WHETHER IN CONTRACT, IN TORT, OR ON ANY OTHER BASIS, FOR ANY INDIRECT, SPECIAL, PUNITIVE, EXEMPLARY, CONSEQUENTIAL, OR INCIDENTAL LOSS, COST, OR DAMAGE ARISING OUT OF OR IN CONNECTION WITH THE SALE, MAINTENANCE, USE, OR INABILITY TO USE THE PRODUCT, EVEN IF GLEN DIMPLEX AMERICAS OR ITS DIRECTORS, OFFICERS, OR AGENTS HAVE BEEN ADVISED OF THE POSSIBILITY OF SUCH LOSSES, COSTS OR DAMAGES, OR IF SUCH LOSSES, COSTS, OR DAMAGES ARE FORESEEABLE. IN NO EVENT WILL GLEN DIMPLEX AMERICAS, OR ITS OFFICERS, DIRECTORS, OR AGENTS BE LIABLE FOR ANY DIRECT LOSSES, COSTS, OR DAMAGES THAT EXCEED THE PURCHASE PRICE OF THE PRODUCT. SOME JURISDICTIONS DO NOT ALLOW THE EXCLUSION OR LIMITATION OF INCIDENTAL OR CONSEQUENTIAL DAMAGES, SO THE ABOVE LIMITATION OR EXCLUSION MAY NOT APPLY TO THE PURCHASER.

*How State and Provincial law apply*

This limited warranty gives you specific legal rights, and you may also have other rights which vary from jurisdiction to jurisdiction. The provisions of the United Nations Convention on Contracts for the Sale of Goods shall not apply to this limited warranty or the sale of products covered by this limited warranty.

*We value your feedback!*

Your input helps to create even better products and experiences.

Share the warmth and leave a review.  
[dimplex.com/sharethewarmth](https://dimplex.com/sharethewarmth)



 [YouTube/Dimplex](https://www.youtube.com/Dimplex) 

1-888-346-7539 | [www.dimplex.com](https://www.dimplex.com)

In keeping with our policy of continuous product improvement, we reserve the right to make changes without notice.

© 2022 Glen Dimplex Americas

**Glen Dimplex**   
**AMERICAS**

Enhancing the moments that matter in life.