

SciPlus-3200

Scientific Calculator

Copy downloaded from
www.sightenhancement.com

For a high-quality spiral bound copy please
contact Sight Enhancement Systems

SPECIAL NEEDS
COMPUTERS 
1-877-724-4922

User Guide

Table of Contents

Getting Started	1
Charging your SciPlus-3200	2
Auto Shutoff	2
The SciPlus-3200 Display	3
SciPlus-3200 Operations.....	4
Soft Keys	4
A Note Regarding Nomenclature:	4
Working with Previous Results	5
Implied Operators	5
Settings	6
Basic Functions	9
Mathematical Functions.....	11
Trigonometry.....	13
Converting Angles	14
Converting Coordinates between Polar and Rectangular.....	15
Memory Operations	16
Statistical Operations	18

Working With Fractions.....	20
Errors.....	21
Troubleshooting	22
Service	23
Warranty	23

Getting Started

Your SciPlus-3200 calculator performs a wide variety of mathematical, statistical, and trigonometric calculations. This User Guide will explain how to get the best from your calculator. Let's first get familiar with the SciPlus controls.



Charging your SciPlus-3200

Charging the calculator is easy. Your SciPlus-3200 calculator includes a USB Wall Charger and cord. Simply plug the USB wall charger into a regular outlet, and plug the USB cable into the SciPlus-3200. The calculator should fully charge overnight. On a full battery the SciPlus-3200 will operate for about 6-8 hours of continuous use. Note this is less than an ordinary calculator because of the bright backlight, which makes the display much easier to read.

When the SciPlus-3200 is charging, you will notice the battery symbol is animated. The battery is completely charged if when the animation stops and three solid bars are shown.

Note: If your SciPlus has been unused for a very long time, you may need to charge it for a while before it will even turn on. When this happens, make sure you “RESET” the SciPlus by carefully inserting a paperclip into the hole on the backside of the calculator. This restores factory settings to ensure proper operation.







Auto Shutoff

Your SciPlus-3200 calculator will automatically shut off after a few minutes of inactivity. Many of the calculator’s current settings such as the angle mode, number format, etc., will be saved, so that it will turn on again in the same state. Values stored in memory and the statistics table are also saved.

If the calculator is left off for an extended period (typically many weeks), these settings may be lost.

The SciPlus-3200 Display

The SciPlus-3200 screen has four lines. The bottom line with the flashing red cursor is where you enter expressions. The other three lines show the results of previous operations. Once you press  an expression is evaluated and its result is moved up a line, leaving the bottom line empty to enter another expression.

Note: When lengthy expressions or results do not fit on the screen you will notice a  or  as shown in the diagram. This is to indicate that characters are hidden to the left or right. Use the     keys to move the cursor. In expressions use the backspace key  to delete what is to the left of the cursor and edit the expression.

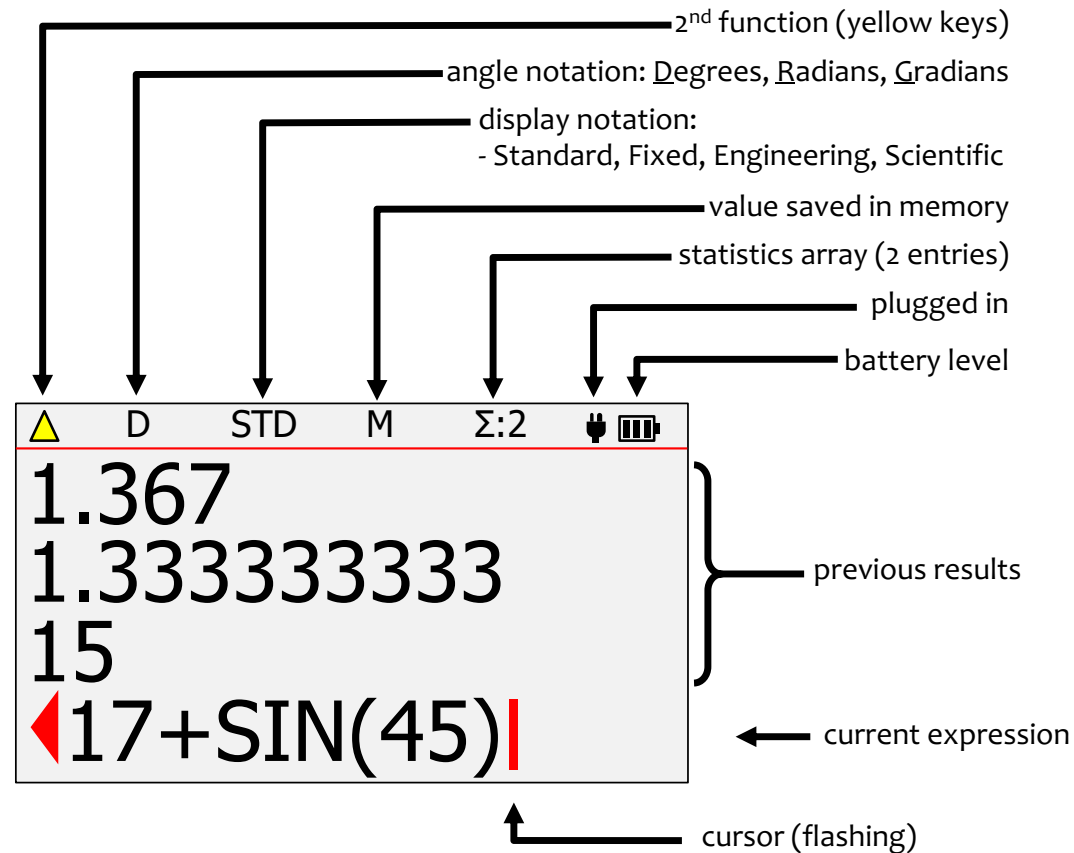



The characters above the horizontal red line at the top of the screen show the **status line** of the calculator. If the battery symbol is animated, this indicates that the battery is being charged. Some of the characters in the status line may not appear at all times. For example, if there is no entry in memory, or if the statistics register is currently empty, these items will not appear.





SciPlus-3200 Operations

The SciPlus-3200 follows the “BEDMAS” rule for order of operations:







Brackets → Exponents → Divide → Multiply → Addition → Subtraction

Many of the SciPlus-3200 keys have two functions. The lower function appears in a white font. The alternate function appears in a yellow font. To access this function, the  key must first be pressed. You will notice a yellow up arrow  in the status line when you do this. Throughout the key descriptions below, if a key symbol appears in a yellow background, this indicates that the  key must be used.





Soft Keys

The keys     do not have a specific function. Instead, labels at the bottom of the display define the function of these keys. If there are no labels, these keys will not do anything. You will use these keys when adjusting the SciPlus-3200’s settings, and for memory and statistics operations.

A Note Regarding Nomenclature:

Throughout this manual, a key press is indicated either by the key image or a boldface blue character. For example,  indicates the  key on the keyboard. Note that sometimes boldface blue characters might be implemented using the SciPlus-3300's soft keys    .

Working with Previous Results

When entering expressions in the bottom line, it's very easy to use the results of previous calculations displayed in the lines above it. Using the   keys, position the cursor at the location in the expression where you wish to insert a previous result. Now, using the   keys, select the previous result that you wish to insert into the current expression, and press .

Implied Operators

In some cases there is no need to enter  in an expression. Here are some examples:



2 (3+1) is the same as **2 × (3+1)**

2 sin(30) is the same as **2 × sin(30)**

2 π is the same as **2 × π**



(3 + 2) (7 ÷ 3) is the same as **(3 + 2) × (7 ÷ 3)**

Settings

There are four settings screens in the SciPlus-3200, accessed by the  key. Cycle through the settings screens using  , or by entering **1** through **4**. Change settings using the **A B C D** keys.

Number Format (Settings Screen #1)

There are four number formats supported by the SciPlus-3200:

1 NUM FORMAT			
STD	SCI	0 1 2 3	
		4 5 6 7	
FIX	ENG	8 9	
		-	+
A	B	C	D

Standard:

Numbers show up to ten-digit precision.

Examples: 101, 41250.5, 0.3333333333

Fixed Notation:

Number of decimals is fixed.

Examples: 101.00, 41250.50, 0.33

Scientific Notation:

Numbers are displayed in powers of ten, with a fixed number of decimals.

Examples: 1.01E+02, 4.13E+04, 3.30E-01

Engineering Notation:

Numbers displayed in powers of ... 10^{-6} , 10^{-3} , 10^0 , 10^3 , 10^6 ..., with fixed decimal precision. These steps express values corresponding with “micro, milli, kilo, mega, etc.”.

Examples: 101, 41.25E+03, 333E-03

Screen Color Options (Settings Screen #2)

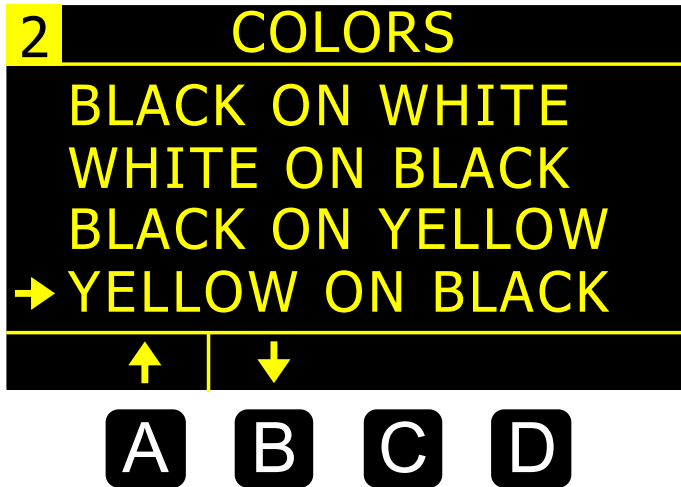

Often, people with low vision are able to benefit from different color options. Use **A** and **B** to scroll through the available options.

As you scroll through the options you will notice the calculator display changes accordingly.

Highlight Color Options (Settings Screen #3)

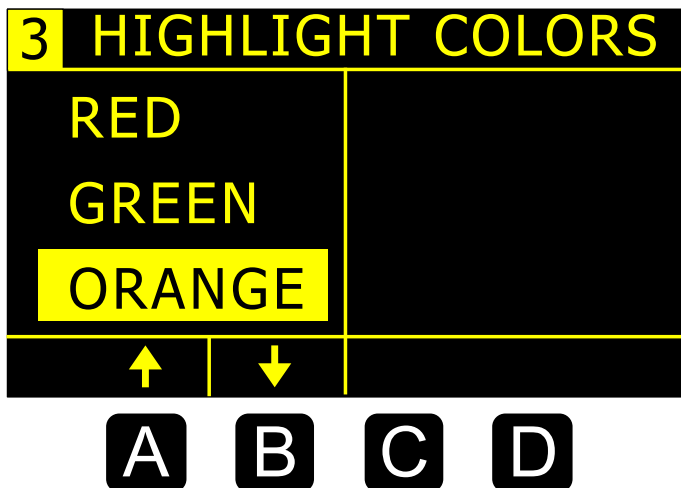

Highlight colors are used for items like the cursor and overflow arrows.

Use **A** and **B** to select the highlight color.



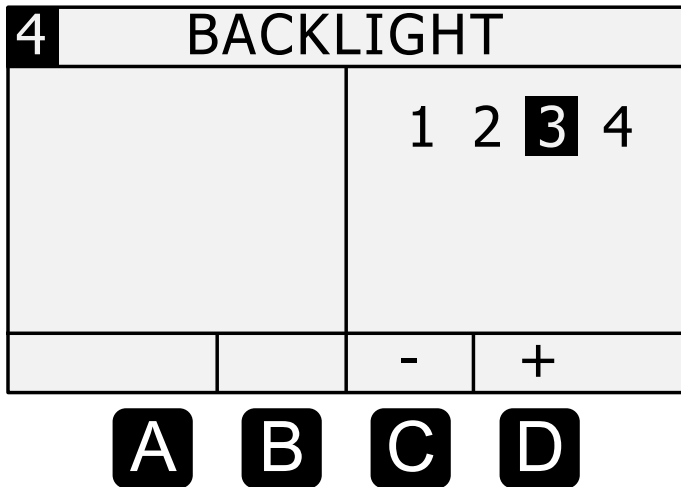

Backlight Brightness (Settings Screen #4)











Use the **C** and **D** softkeys to adjust the brightness of the backlight. Maximum brightness will create the most contrast in brightly lit environments. Lowering the brightness will extend the battery life between charging.





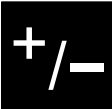





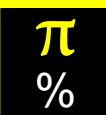



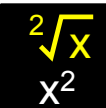

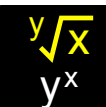







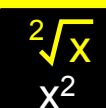

Basic Functions











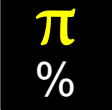











The tables below describe the functions of the SciPlus-3200 calculator. Note that several examples are included. You will find that some functions automatically introduce a left bracket “(”, indicating that you need to enter an expression, which could be as short as a simple number, or a long mathematical expression. For these functions you must close the expression with a right bracket “)”.

KEY	NAME	DESCRIPTION
	2 nd Function	Press this key before any dual-function key to access the upper (yellow) function. You will notice the  symbol flashing in the status line. Note: In this table, if the key symbol at right appears on a yellow background, the description applies to the upper (yellow) function.
	ON/Clear	Turn calculator ON. The cursor will appear on the bottom line. Most of the settings from the previous session will remain as they were. If the calculator is already on this key clears the bottom line.
	OFF	Save settings, memory and statistics data, and turn calculator OFF.
	Backspace	Delete last entry or function.

KEY	NAME	DESCRIPTION
	Enter (=)	Resolves the current expression, displaying the result in the second line. If the expression contains errors, an error message will appear.
	Clear Screen	 then  clears the current expression and all previous results.
	Open Parentheses	Open parentheses. Note that some expressions will automatically include the opening parentheses.
	Close Parentheses	Close parentheses.
	Change Sign	Change the sign of the operand. After some operators (e.g. \times \div), this operation will insert a negative sign into the expression.
	Scientific Notation	This is equivalent to “ $\times 10$ raised to the power...”
	Settings	Manage settings (see section on Settings). Toggles on/off.

















Mathematical Functions

KEY	NAME	DESCRIPTION
	Pi	Enters the symbol π into an expression. If you press   then  the result 3.141592654 will be displayed.
	Factorial	Calculates the factorial of the value to the left. Enter this <i>after</i> you enter the value of 'x'.
	X^2	Squares the value to the left. Enter 'x' first. e.g.: 10  followed by  yields a result of 10^2 , or 100.
	y^x	Raises the value to the left, to an exponent. Enter 'y' first. Shown as '^'. e.g.: 2  3 followed by  yields a result of 2^3 or 8.
	Reciprocal	Calculates the reciprocal of an expression in brackets. e.g.:  25  4  followed by  yields 1/100, or 0.01.
	Square Root	Calculates the square root of a value. e.g.:   4 followed by  yields $\sqrt{4}$, or 2.
	n^{th} Root	Calculates the n^{th} root of a value. e.g.: 3   8 followed by  yields the $\sqrt[3]{8}$, or 2.
	LOG	Calculates the base10 logarithm of an expression in brackets. e.g.:  25  4  followed by  yields $\log_{10}(100)$, or 2.

KEY	NAME	DESCRIPTION
	Percentage	<p>The behavior of the % function depends upon context.</p> <p>If the expression is simply a number with the % operator, the result of the expression is the number divided by 100.</p> <p>If the % operator is appended to a number which is itself to the right of the + - × or ÷ operator, the percentage is added to, subtracted from, multiplied by, or divided by the number to the left of the operator.</p> <p>e.g.: 3  50  followed by  yields a result of 4.5.</p> <p>If used in a larger expression the operand must be enclosed in brackets.</p> <p>e.g.:  (3  50 )  1  results in 5.5</p> <p>If  is followed by any operator without a preceding closing bracket as shown above example, a Syntax Error will result.</p>
	LN	<p>Calculates the natural logarithm of an expression.</p> <p>e.g.:  25  4) followed by  yields ln(100), or 4.605170186.</p>
	e^x	<p>Calculates the value of e (2.2718282) raised to an expression.</p> <p>e.g.:   2  3) followed by  yields e^5, or 148.4131591.</p>
	10^x	<p>Calculates the value of 10 raised to a value.</p> <p>e.g.:   5 followed by  yields 10^5, or 100000.</p>















Trigonometry

Trigonometry functions are very straightforward with the SciPlus-3200. Note that the values used in trigonometry functions, and the result, are expressed in Degrees, Radians, or Gradians, as indicated by ‘D’ ‘R’ or ‘G’ in the status line. The examples shown below assume the SciPlus-3200 is in “DEGREES” mode.















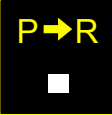

KEY	NAME	DESCRIPTION
 	Sine	Calculates the sine of an expression. e.g.:  30  followed by  yields 0.5.
 	Arcsine	Calculates the inverse sine (arcsine) of an expression. e.g.:   0.5  followed by  yields 30.
 	Set Angle Mode	This simply toggles through Degrees, Radians, Gradians. The current setting is indicated in the status line. After setting this parameter, subsequent input values and the results of expressions are expressed accordingly.
 	Convert Angle	  converts the current value displayed in the second line , and changes the status line parameter.

The Cosine and Tangent functions, and their inversions, work the same way.

Converting Angles











KEY	NAME	DESCRIPTION
	Decimal Degrees to DMS	<p>Converts decimal degrees into degrees, minutes, seconds. e.g.:   45.5  followed by  yields (45,30,0.00).</p> <p>Note that if the second line is in DD format, entering   followed by  converts that value into DMS format.</p>
	DMS to Decimal Degrees	<p>Converts degrees, minutes, seconds into decimal degrees. e.g.:  45,30,0  followed by  yields (45.5)</p> <p>Note that if the second line is in DMS format, entering  followed by  converts that value into DD format.</p>

Converting Coordinates between Polar and Rectangular

KEY	NAME	DESCRIPTION
	Rectangular to Polar	<p>Converts rectangular (x,y) coordinates into polar (r,θ). Note that angles are expressed in degrees, radians or gradians as indicated on the status line.</p> <p>e.g.:   1 , 1  followed by  yields (1.41,45.00)</p> <p>Note, if the result line is in rectangular (x,y) format, entering   followed by  converts that value into polar (r,θ) format.</p>
	Polar to Rectangular	<p>Converts polar (r,θ) coordinates into rectangular (x,y). Note that angles are entered as degrees, radians or gradians as indicated on the status line.</p> <p>e.g.:   1.41 , 45  followed by  yields (1.00,1.00)</p> <p>Note that if the second line is in polar (r,θ) format, entering   followed by  converts that value into rectangular (x,y) format.</p>

Memory Operations

Note that some memory operations with the SciPlus-3200 use the soft keys **A - D**.

KEY	NAME	DESCRIPTION
	Save Value to Memory	Saves the current value into memory. If used at the end of an expression (instead of ) , the expression is solved, and the result stored.
	Recall Value from Memory	Enters ‘RCL’ as a variable in the current expression. When the expression is evaluated, the value currently stored in memory is used. To display the value currently in memory enter  followed by  .
	Display Memory Soft Keys	  causes the memory soft keys to be displayed. Note that there are two sets. Pressing   a second time will bring up the second set of soft keys. A third time will disable the soft keys.

Soft keys **A B C D** are used to clear the memory, swap the value in memory with the current line, and perform simple arithmetic operations (+ - × ÷) on the value stored in memory using the current line. Memory soft keys are shown on the opposite page. In this example, the value ‘15’ resides in the current line. Note that storing a value of ‘0’ clears the memory.





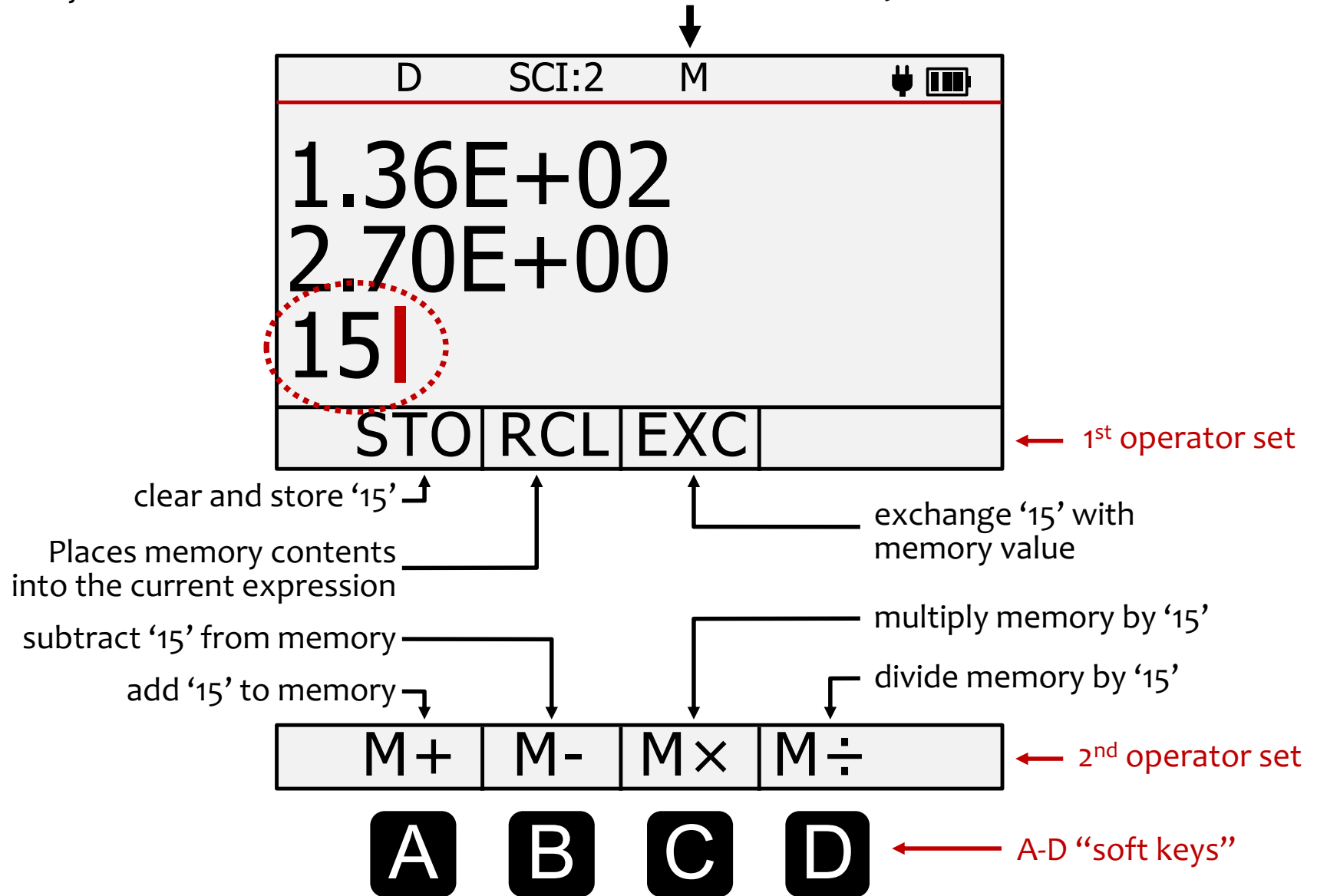



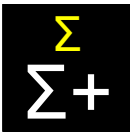

Memory Soft Keys:



“M” indicates there is a value in memory



Statistical Operations

The SciPlus-3200 performs statistical operations on a table of up to 99 entries. Note that most statistical operations with the SciPlus-3200 use the soft keys **A - D**.

KEY	NAME	DESCRIPTION
	Add Data Point in Stats Register	<p>Adds the current value into the statistics table. If pressed at the end of an expression, the expression is solved, and the result added. Note that if a value already exists in the table, it will be added a second time.</p> <p>e.g.: 2  3  5  3  will create a table (2, 3, 5, 3)</p>
	Display Statistics Soft Keys	<p>  causes the statistics soft keys to be displayed. Note that there are two sets. Pressing   a second time will bring up the second set of soft keys. A third time will disable the soft keys.</p>

Soft keys **A B C D** are used to perform various statistical operations. Statistics soft keys are shown on the opposite page. Just enter the soft key followed by  to display that value in the second line. For example, for the table (2, 3, 5, 3), selecting **C**  will show the mean value 3.25.







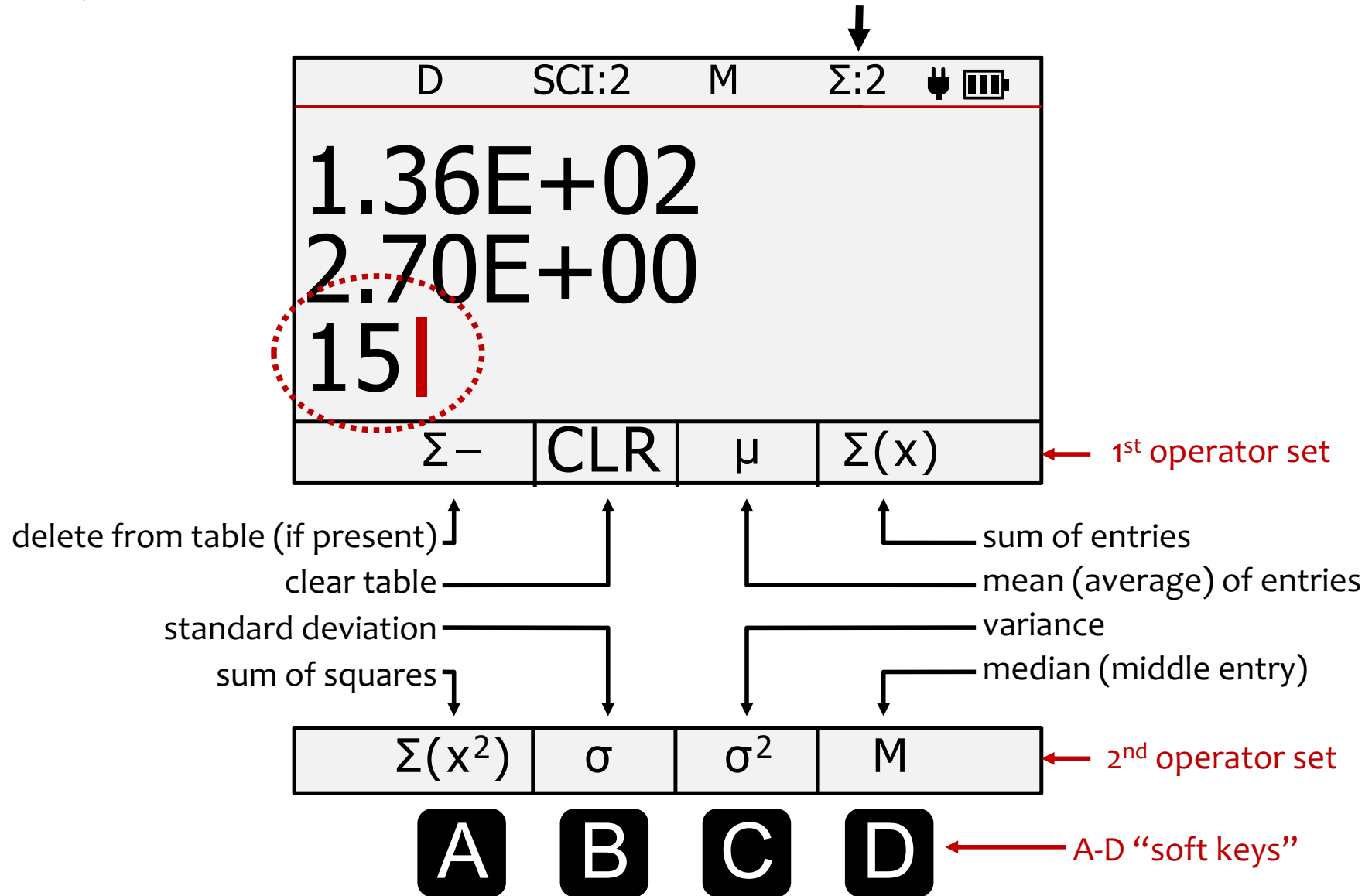















Note: μ , $\Sigma(x)$, $\Sigma(x^2)$, σ , σ^2 and **M** can all be used in expressions.

Statistics Soft Keys:

indicates there are two entries in the statistics table



Working With Fractions



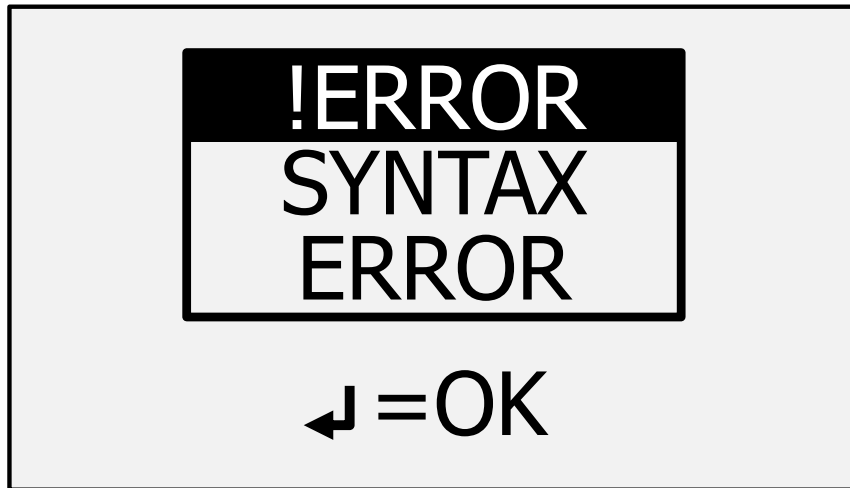

KEY	NAME	DESCRIPTION
	Enter a Fraction	<p>Use this key to enter a fractional amount into an expression. The result is displayed as a fractional amount ONLY if all the operands in the expression are entered as either fractions or integer numbers.</p> <p>e.g.: 2    4 , 3  6  followed by  yields 6 1/2</p> <p>2.0    4 , 3  6  followed by  yields 6.5</p> <p>Note: If no whole number component and comma (“4 ,” in the examples above is entered it is assumed that the whole number component of the fraction is zero.</p> <p>e.g.: 2.0    3  6  followed by  yields 2.5</p>
	Convert Between Fraction and Decimal	<p>Pressing    without any arguments converts the contents of the second line from fraction to decimal (or vice versa).</p>

Errors



Sometimes you'll enter things incorrectly, such as not closing a bracket or dividing by zero. In this case, you'll get a **SYNTAX ERROR** message like the image at left.

You might see other types of error messages such as "INVALID ARGUMENT" or "INFINITE RESULT".

To remove this message simply press . This returns you to the entry line. Use the    keys to correct the error.

Troubleshooting

Battery does not recharge:

The SciPlus battery may fully discharge after a month or more of inactivity. Simply plug in the calculator as if to recharge, for about half an hour. Next, perform a reset by inserting a paper clip into the small hole on the underside of the calculator, and gently push until you hear/feel a small click. Then keep the calculator plugged in at least overnight to fully recharge.

If a reset does not resolve the problem, determine whether it is an issue with the USB charger or cord by attempting to recharge with another USB charger and /or cord.

SciPlus calculator is acting erratically:

Perform a reset by inserting a paper clip into the small hole on the underside of the calculator, and gently push until you hear/feel a small click.

Service

If for any reason you require service or support for your SciPlus-3200, please contact the authorized dealer from whom it was purchased.

If you purchased directly from Sight Enhancement Systems, contact **service@sightenhancement.com** and include the following information:

- The serial number of the SciPlus-3200 (see the label on the underside of the calculator).
- A description of the problem.

The robustness of Sight Enhancement Systems SciPlus calculator is legendary, and you should enjoy years of reliable operation

Warranty

The SciPlus-3200 is covered by a one year limited warranty from the date of purchase. Warranty includes parts, labour and shipping costs. Goods may be returned only upon authorization by Sight Enhancement Systems. Warranty covers "normal wear and tear", and does not cover damage resulting from obvious misuse of the product. Examples of misuse include, but are not limited to, damage due to exposure to moisture or extreme heat, damage due to dropping the device, and physical damage to connectors and plugs.

Copy downloaded from
www.sightenhancement.com

For a high-quality spiral bound copy please
contact Sight Enhancement Systems



sight
enhancement
systems

364 Huron Avenue South
Ottawa, Ontario
K1Y 0W7
CANADA

www.sightenhancement.com