

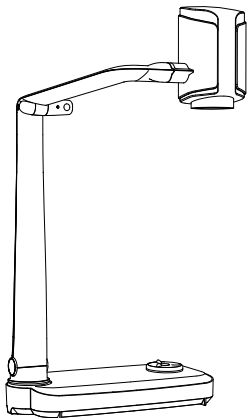

# Document Camera

---



User Manual

# 1. Package list

Document Camera

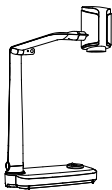

Remote Controller



CD



USB2.0 Cable



HDMI Cable

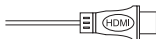

VGA Cable

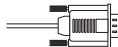

DC Adapter (12V1A)

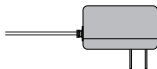

Location Soft Pad

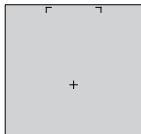







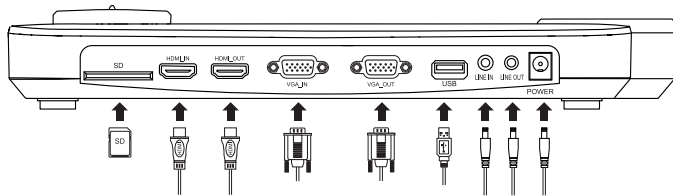
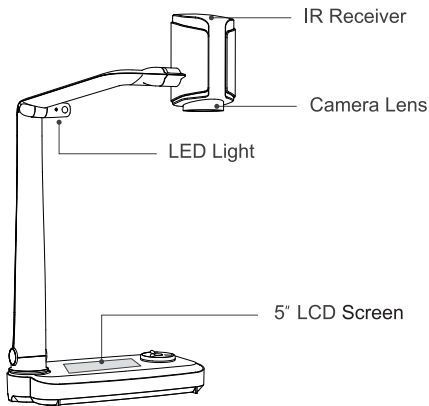

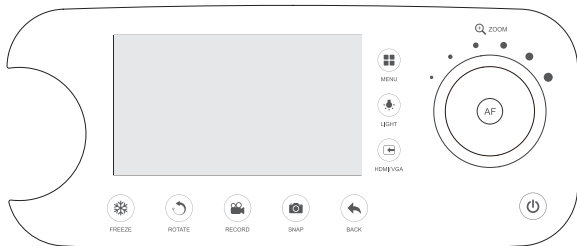

User Manual



## 2. Remote control and interface instruction





-  Menu
-  on/off LED Light
-  Change to HDMI/VGA
-  Freeze the image
-  Rotate image by 90°/180°/270°/360°
-  Record a video clip
-  Capture a still image
-  Change the resolution/back to main menu
-  Press to realize the function/auto focus
-  Power on/off

## 3. Device connection

### PC Connection

- 1.Plug in the power adapter to the power socket and Document Camera.
- 2.Connect the USB cable to the PC and Document Camera.
- 3.Install the software.

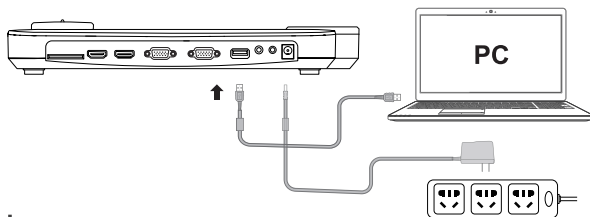





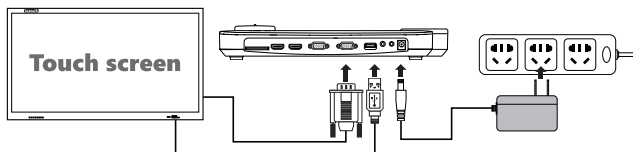

### PC-Less

- 1.Plug in the power adapter to power socket and Document Camera.
- 2.Connect the HDMI/VGA cable to the Document Camera and Touch screen.
- 3.Connect the USB cable to the Document Camera and Touch screen (touch usb port).

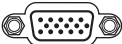
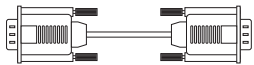

★ Calibration need to be done first for the touch function after connection.

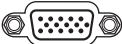
Document Camera and external equipment connections as below:

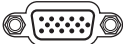
Document Camera Interface	Connection Cable	External Equipment Interface
HDMI_OUT 		HDMI_IN 
VGA_OUT 		VGA_IN 
VGA_IN 		VGA_OUT 

## 4. Attention

### Before use:

- Do not leave it under direct sunlight or by heaters. It maybe discolored or damaged.
- Do not place this product in any humid, dusty, or vibrating locations.
- Carry the product by holding the base in both hands. Never hold the product by the arm or the camera head.
- Use a soft, dry cloth for cleaning instead of any volatile solvent.
- When the device is not in use for a while, please turn off the power.
- Fold the arm when the product will not be used for a long time.

## **During use:**

- Please prevent children from operating the device without supervision.
- Recommended environmental conditions: Temperature: 0°C - 40°C (32°F - 104°F) .
- Humidity: 30% - 85% (No condensation) .
- Use the product on a stable base, desk, or table.
- Do not turn or flip the camera head or arm to its limitation as below manual instructs.
- Do not point the camera lens directly at the sunlight. It may be damaged and fails to take pictures.
- Do not look directly to the LED lamps to prevent your eyes from being damaged.
- The product may not be operated properly if a USB hub is used to connect the product and a PC.
- ransfer the data from the SD card onto a device such as a PC to save a backup copy.Malfunction of the product or repairs may cause the data in the SD card to be deleted
- Be careful to prevent the unit from dropping or overturning
- Please prevent the camera head to hit the desk top or any other hard objects, or it can be damaged easily.

# Warranty card

Model \_\_\_\_\_

Add \_\_\_\_\_

Tel \_\_\_\_\_

E-mail \_\_\_\_\_

Date \_\_\_\_\_

## Certification

Model \_\_\_\_\_

Insrpctor No. \_\_\_\_\_

Production date \_\_\_\_\_

Manufacturer Joyusing Technology Co., Ltd.



## Joyusing Technology Co., Ltd.

Website: [www.joyusing.com](http://www.joyusing.com)

Tel: 0086-591-86399086

Email: [sales@joyusing.com](mailto:sales@joyusing.com)

Address: No.27 Yangzhou Road Cangshan District, Fuzhou, Fujian, China