



# User Guide

V 3.0

## Contents

1. What's in the box .....	4
1.1 Device accessories .....	4
1.2 Headset .....	5
1.3 Controller .....	6
2. Getting started .....	7
2.1 Preparing to use Acesight VR.....	7
2.1.1 Charging the device .....	7
2.1.2 Turn Acesight VR on/off .....	9
2.1.3 Turn the controller on/off.....	11
2.2 Put on the headset .....	12
2.2.1 Wearing the headset.....	12
2.2.2 Adjust the focus.....	12
3. Basic functions .....	13
3.1 Activate/exit sleep mode.....	14

3.2	Zoom in/out .....	15
3.3	Focus Lock .....	15
3.4	Color mode & outline display .....	16
3.4.1	Change color mode & outline display .....	16
3.4.2	Favorite color mode .....	17
	Adjust thickness of outlines/contrast of high contrast colors .....	18
4.	Advanced functions .....	19
4.1	Freeze image .....	19
4.1.1	View the frozen image .....	19
4.1.2	Zoom in/out the frozen image .....	20
4.2	Find function .....	21
4.3	Menu .....	22
4.3.1	Favorite magnification .....	23
4.3.2	Screen brightness .....	25
4.3.3	Select favorite color mode .....	25
4.3.4	Set the narrow display .....	26

4.3.5 Factory reset .....	29
4.4 Other buttons on headset .....	29
5. Note on use.....	32
6. Technical specifications.....	32

## 1. WHAT'S IN THE BOX

### 1.1 DEVICE ACCESSORIES

- Headset
- Controller

- Power Adapter & Cable
- User Guide
- Carrying Case

## 1.2 HEADSET

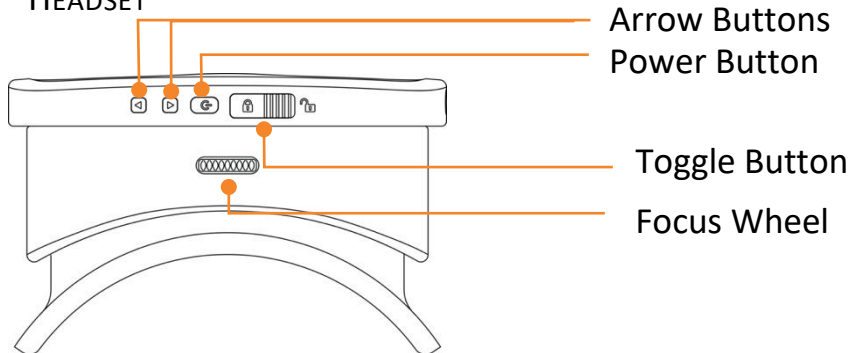

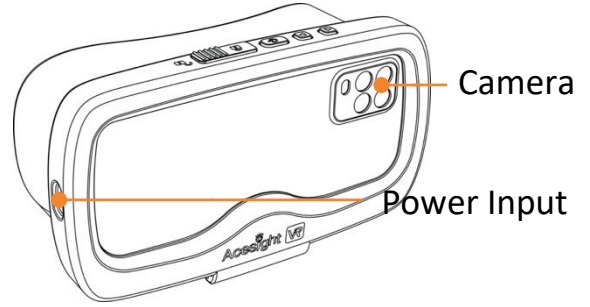
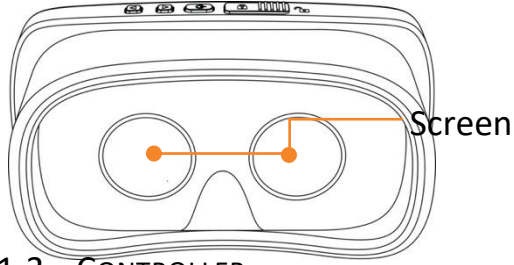

### 1.3 CONTROLLER

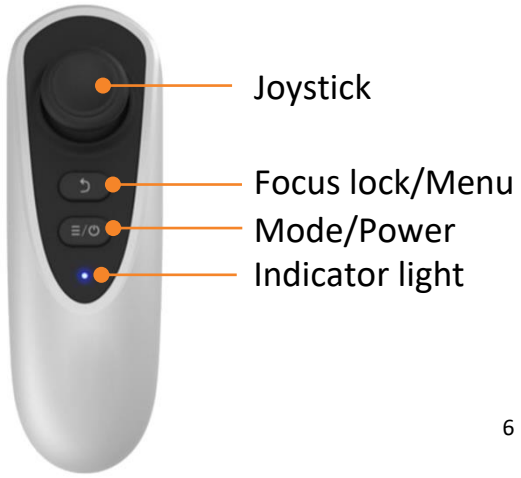

## 2. GETTING STARTED

### 2.1 PREPARING TO USE ACESIGHT VR

#### 2.1.1 CHARGING THE DEVICE

➤ HEADSET:

To charge the headset, connect the headset (power input port) with the charger (included). When the battery icon on the Acesight VR screen

turns to , the battery level is low. Please charge the device. It takes less than 1.5 hours to fully charge the battery.

Short press the Power Button two times to check the current battery level.

➤ CONTROLLER

The controller is non-rechargeable. Change the AAA batteries in the controller when the battery is in low power or runs out of power.

Remove the bottom cover by inserting a fingernail or

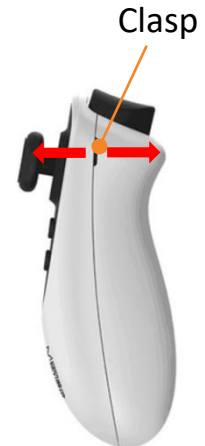



small tool in order to replace the battery.

### 2.1.2 TURN ACESIGHT VR ON/OFF

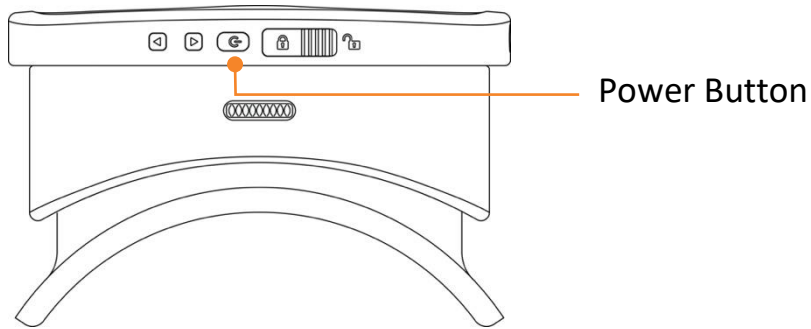

#### **Switching on Acesight VR:**

Under regular circumstances a single press of the Power Button on the headset is all that is required to wake Acesight VR from sleep mode. The

first time you switch on the device, it may be necessary to press the Power Button on the Headset for about 3 seconds. You may feel a slight vibration to indicate the unit is starting up. This process takes about 15 seconds. Acesight VR is ready when you see the image on the screen.

### **Switching Off Acesight VR:**

Acesight VR will enter sleep mode when you press the power button, or by removing the device from your head and placing it on a table or other surface. After 5 minutes the screen will switch off and the device will enter sleep mode automatically. Acesight VR can remain in Sleep mode

for days without any noticeable change in battery charge and woken up instantly with a single press to the power button. It's very convenient.

Acesight VR will shut off automatically when the battery runs out.

NOTE: To maintain a fully charged battery, leave Acesight VR connected to power when not in use.

### 2.1.3 TURN THE CONTROLLER ON/OFF

Press the Power Button on the controller for 3 seconds to turn it on/off. The indicator light on controller will flash blue one to two times before it is connected with the headset successfully.

## 2.2 PUT ON THE HEADSET

### 2.2.1 WEARING THE HEADSET

Step 1: Place the headset over your eyes and pull the strap back over your head.

Step 2: Adjust the strap to ensure a comfortable fit.

**NOTE: Do not attempt to walk while wearing Acesight VR.**

### 2.2.2 ADJUST THE FOCUS

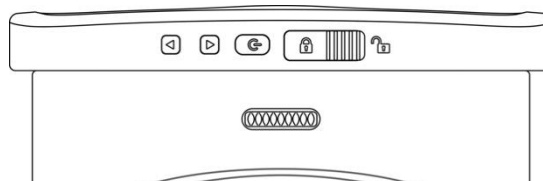



Step 1: Pick an object or face at least 4 feet (1.2m) away to look at, such as a picture on the wall.

Step 2: Rotate the Focus wheel on the top of the Acesight VR headset to the left or right until the object is in focus.

### 3. BASIC FUNCTIONS

### 3.1 ACTIVATE/EXIT SLEEP MODE

When the unit has been powered on, press Power Button on the top of the headset to activate or exit sleep mode. The screen will turn black when the headset goes into sleep mode. The unit can also wake up by pressing any button (joystick excluded) on the controller.

To save power, the headset will go into sleep mode automatically after 5 minutes of inactivity.



We recommend connecting Acesight VR to an electrical outlet when not in use, to help ensure it is fully charged each time you wish to use it.

### 3.2 ZOOM IN/OUT

Push the joystick up or down to zoom in or zoom out.

The magnification range of Acesight VR is 1x to 16x.

### 3.3 FOCUS LOCK

In general, the camera of Acesight VR is auto-focus. However, if focus lock function is needed, single click Focus Lock button to turn off auto focus. And click it again to go back to auto focus. Icon  or 

will appear in the lower right corner of the screen when Focus Lock is on or off.

The icon  indicates Focus Lock function activated.

The icon  indicates Focus Lock function is off.

### 3.4 COLOR MODE & OUTLINE DISPLAY

#### 3.4.1 CHANGE COLOR MODE & OUTLINE DISPLAY

Press the Mode Button to switch among Focus lock, 4 high contrast colors and 3 outline displays:

➤ 4 HIGH CONTRAST COLORS

<b>White on Black</b>	<b>Black on White</b>
<b>Yellow on Black</b>	<b>Black on Yellow</b>



➤ 3 OUTLINE DISPLAYS

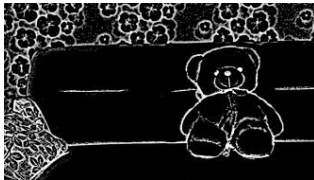

White on Black

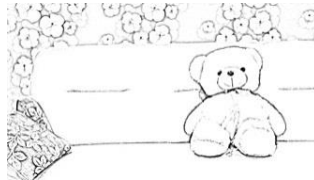

Black on White



Black Outline on Full color

3.4.2 FAVORITE COLOR MODE

You can select favorite color mode in Menu. Please refer to the “Menu” section on page 24 of this guide.

#### ADJUST THICKNESS OF OUTLINES/CONTRAST OF HIGH CONTRAST COLORS

The thickness of the outline and the range of the contrast in high contrast color are adjustable in 5 levels by pushing the joystick left or right to adapt to various eye conditions and environments.

## 4. ADVANCED FUNCTIONS

### 4.1 FREEZE IMAGE

Press the Freeze Button on the controller to freeze the image. You will see the image you are viewing frozen, a pause icon  will appear in the top right corner of the screen.

#### 4.1.1 VIEW THE FROZEN IMAGE

If the frozen image is magnified, move the joystick up/down/left/right to pan around. If the magnification level is at 1X (no magnification) then the Joystick has no function.

#### 4.1.2 ZOOM IN/OUT THE FROZEN IMAGE

Press and hold the Freeze Button first and then push the joystick up/down to zoom in/out the frozen image.

#### 4.1.3 CHANGE THE COLOR MODE OR OUTLINE OF THE FROZEN IMAGE

Press and hold the Freeze Button first, and then push the joystick left/right to change the color modes or outlines.

## 4.2 FIND FUNCTION

In live view, press and hold the Freeze Button. The Find Function will be activated; magnification will zoom out to 1X and the red Find frame appears.

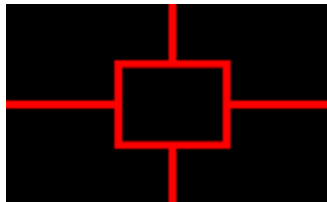

Turn your head and put the Find frame on the target, then release the button. The Find frame disappears and Acesight VR returns to the previously used magnification level.

### 4.3 MENU

Press the Focus lock /Menu Button for 2 seconds to enter Menu. There are five options in the Menu: Favorite Magnification, Screen Brightness, Favorite Color Mode, Narrow Display and Factory Reset.

You can switch among them by pushing joystick left or right. And press the Freeze Button to confirm. Press the Focus lock/Menu Button to exit without change.

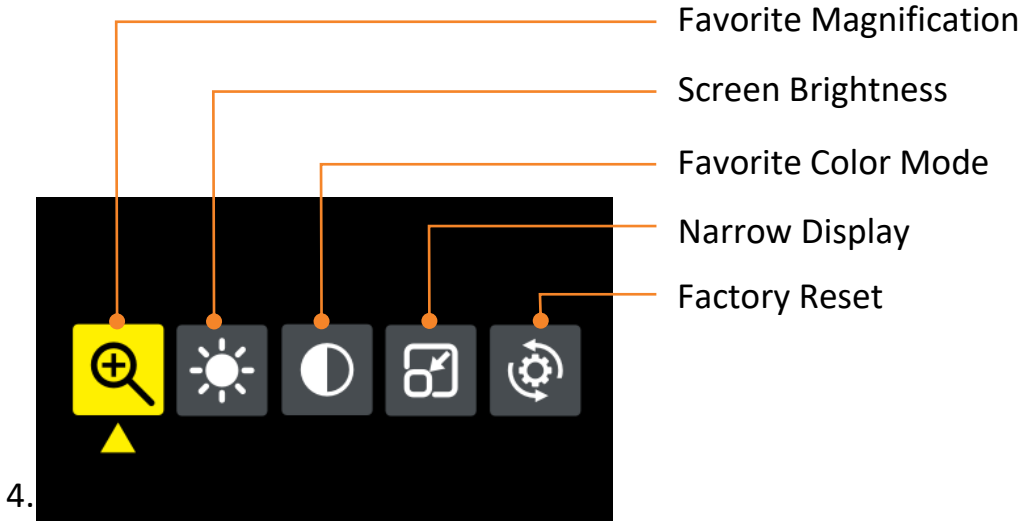

This function enables you to quickly select your favorite magnification in live view.

To set favorite magnification, select the icon  in Menu and press Freeze Button to enter the settings page. In the settings page, push the joystick up/down to select your favorite magnification. Then press Freeze Button to confirm and exit. Or press Focus lock/Menu Button to exit without any change.

In live view, press the Focus lock/Menu Button two times, and the display will change to your favorite magnification.



The default favorite magnification is 1X.

#### 4.3.2 SCREEN BRIGHTNESS

Select the icon  in Menu and press Freeze Button to confirm and enter the settings page. In the settings page, push the joystick left/right to adjust the screen brightness. Then press Freeze Button to confirm and exit. Or press Focus lock/Menu Button to exit without any change.

#### 4.3.3 SELECT FAVORITE COLOR MODE

You can hide contrast color combinations you do not like. There are four high contrast color combinations: white on black, black on white, yellow on black, black on yellow.

Select the icon  in Menu and press Freeze Button to confirm and enter the settings page. In the settings page, push the joystick right/left to move among the colors. Press the Freeze Button to hide or select a specific color mode. Then press Focus lock/Menu Button to confirm and exit.

#### 4.3.4 SET THE NARROW DISPLAY

Narrow display helps people with peripheral vision loss (caused by Retinitis Pigmentosa, Glaucoma etc.) by shrinking the entire image into a smaller viewing area. Movement of the narrow window is also possible to avoid dark spots caused by a scotoma.

Select the icon  in Menu and press Freeze Button to confirm and enter the settings page. An image with three trees will appear on the screen. It shows an original viewable area.

➤ INCREASE/DECREASE THE DISPLAY AREA

Press and hold the Freeze Button first, and then push the joystick down to zoom out the display to fit your need. To go back, push the joystick up to zoom in the display.

➤ CHANGE THE DISPLAY POSITION

By default, the view is in the middle of the display. If that doesn't match your vision, push the joystick up/down/left/right to move the display position. Then press Freeze Button to confirm and exit. If you press Focus lock/Menu Button, it will exit the Menu without any change.

### 1.3.5 FACTORY RESET

This function enables you to reset all the settings. Select the icon  in Menu and press Freeze Button to confirm and enter the settings page. To reset the settings, select “Yes” by pushing joystick left/right and press Freeze Button to confirm. If you select “No” or press Focus lock/Menu Button, it will exit without any change.

### 4.4 OTHER BUTTONS ON HEADSET

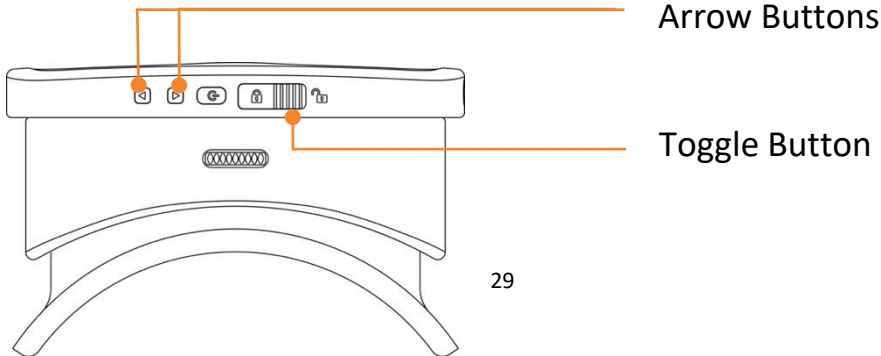



**NOTE: The purpose of the Arrow Buttons and Toggle Button relates to after-sales service and technical support trouble shooting. Do not use them unless instructed to do so by Zoomax or your distributor.**

1. Arrow Buttons:

If the Acesight VR app does not start automatically, press and hold both Arrow Buttons simultaneously for 3 seconds to reopen it. “Accessibility shortcut turn Acesight VR on” will display on the screen when the app turns on.

## 2. Toggle Button:

Toggle Button is designed to lock and unlock the front cover. This might be necessary if access to the screen is needed. To open the cover, slide the Toggle Button to unlock side "  ", then open the cover slightly. To close the cover, first replace it and slide the Toggle Button to the lock side "  ".

**IMPORTANT:** Do not attempt to repair Acesight VR or open its case to avoid voiding the warranty. Contact Zoomax support or your distributor if necessary.

## 5. NOTE ON USE

Avoid using Acesight VR in the following locations.

- Places exposed to high temperature and/or high humidity.
  - Outside when it is wet or raining.
  - Outside in full sun for extended periods of time.
  - Locations subject to electromagnetic interference, such as next to medical devices that are unshielded.
- a) If Acesight VR becomes soiled, wipe it off using a soft, dry cloth. Use of organic solvents (such as thinner or benzene) causes deterioration and discoloration of the outer casing.

## 6. TECHNICAL SPECIFICATIONS



- Magnification: 1X - 16X
- Camera: 48 MP
- Screen resolution: 2340 x 1080 FHD
- FOV: 65°
- Refresh rate: 60fps
- Weight of headset: 1 pound (442g)
- Weight of controller: 0.14 pound (65g)
- Dimensions of Headset: 7 x 4.7 x 3.9 in (18 x 12 x 10 cm)
- Headset Charging time: less than 1.5 hours
- Headset Battery life: 3.5-4 hours

## **Zoomax Technology Co., Limited**

Add: 9F, Building D, Paradise Software Park, No.3 Xidoumen Rd,

Xihu District, Hangzhou, China 310012

Tel: +86 (0571) 8700-6308

Fax: +86 (0571) 8700-6292

Email: [support@acesight.com](mailto:support@acesight.com)

Visit us at [www.acesight.com](http://www.acesight.com)

