

Annual Competitive Analysis

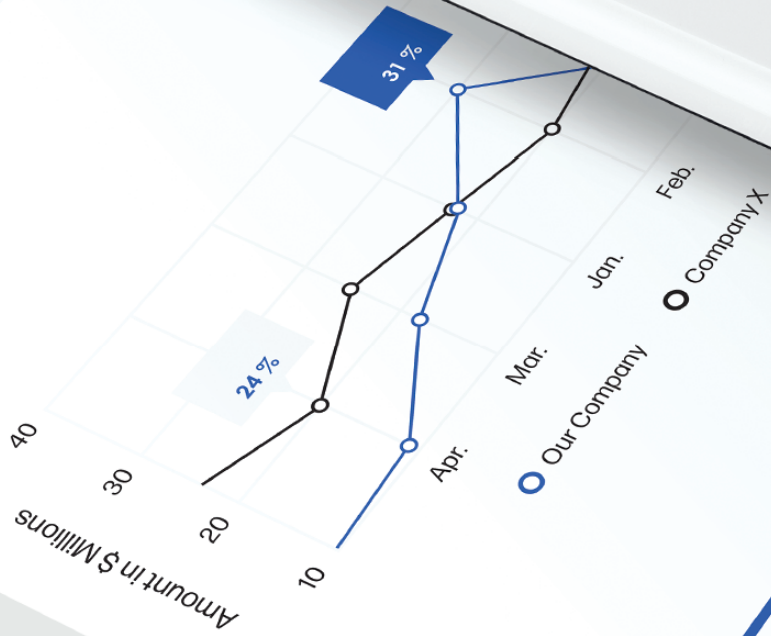

New-Vehicle Sales

Total new-vehicle sales including retail and non-retail transactions are expected to decline 5.7% this month from a year earlier after adjusting for total selling days. Consultants J.D. Power and LMC Automotive said in a report on Wednesday. While the consultants expect the seasonally adjusted annualized rate (SAAR) for total new-vehicle sales in a country to decline by 0.9 million units in the 13.7 million units Cox Automotive forecast slight uptick in SAAR to 13.2 million units.

HP Mobile Scanner PS100

User Manual



Table of contents

Safety precautions	3
Package contents	4
Product overview	4
Setup instructions	5-6
Operating instructions	7-8
Function & LED guide	9
HP WorkScan overview	10-19
Care and maintenance	20
Troubleshooting	21
Specifications	22
Warranty	23-24
FCC statement	25



HP Mobile Scanner

PS100

User Manual

Thank you for purchasing the HP Mobile Scanner. This User Guide is intended to provide you with guidelines to ensure that operation of this product is safe and does not pose risk to the user. Any use that does not conform to the guidelines described in this User Guide may void the limited warranty.

Please read all directions before using the product and retain this guide for reference. This product is intended for household use only. It is not intended for commercial use.

This product is covered by a limited two-year warranty. Coverage is subject to limits and exclusions. See warranty for details.



Safety precautions

WARNING! Please read all safety precautions and instructions carefully before using this product. Failure to properly follow the guidelines established here could result in serious injury or damage to the product. Keep this manual for reference.

- Please turn off and unplug the scanner when it is not in use for long periods of time.
- Do not use the scanner if any parts are missing or damaged.
- Do not attempt to disassemble or repair the scanner yourself.
- Do not use any solvents or corrosive liquid to clean any part of the scanner.
- Keep the scanner out of direct sunlight and humid, dusty environments.
- Always place the scanner on a flat, level surface.
- Do not let any foreign substances enter the product. Do not place heavy objects, liquids, or metals on the product.
- Use only official parts and components provided by the manufacturer for this product.
- Keep small accessories or packaging material away from children.
- If the scanner emits a strange sound, burning smell, or smoke, turn off the power immediately and unplug the power cord. If the scanner is dropped or its exterior is damaged, turn off the power immediately and unplug the power cord.
- Do not let the scanner near water or moisture.
- Use only the USB cable that comes with the scanner. Using any other USB cable may cause a fire, electrical shock, or injury.
- The  symbol indicates DC voltage. The marking information is located at the bottom of apparatus.



Caution

Electronics, such as scanners, are prone to damage by static electricity. Therefore, to protect the scanner from static electricity, be sure to turn off the scanner before connecting or disconnecting the cable to the rear of the scanner. If the scanner is damaged by static electricity, contact your local dealer.

This equipment is not suitable for use in locations where children are likely to be present. When the printer is operating with the cover open, do not wear anything that can touch the drive, such as clothing, necklaces, rings, watches, or employee certificates close to it. Also, keep yourself away from the printer as it is dangerous for some parts of the body to come into contact with it. If an object or part of your body touches the drive, immediately disconnect the power cord or turn off the power switch on the back of the product.



Waste electrical and electric equipment (WEEE)

This marking shown on the product or its literature indicates that it should not be disposed of with other household wastes at the end of its working life. To prevent possible harm to the environment or human health from uncontrolled waste disposal, please separate this from other types of waste and recycle it responsibly to promote the sustainable reuse of material resources. Household users should contact either the retailer where they purchased this product, or their local government office, for details of where and how they can take this item for environmentally safe recycling. Business users should contact their suppliers and check the terms and conditions of the purchase contract. This product should not be mixed with other commercial wastes for disposal.

Package contents

- Scanner
- USB cable
- Calibration sheet
- Quick start guide

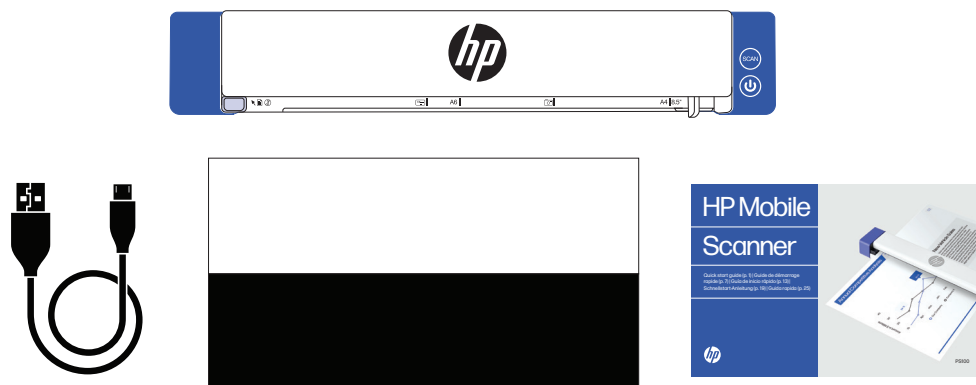

Product overview

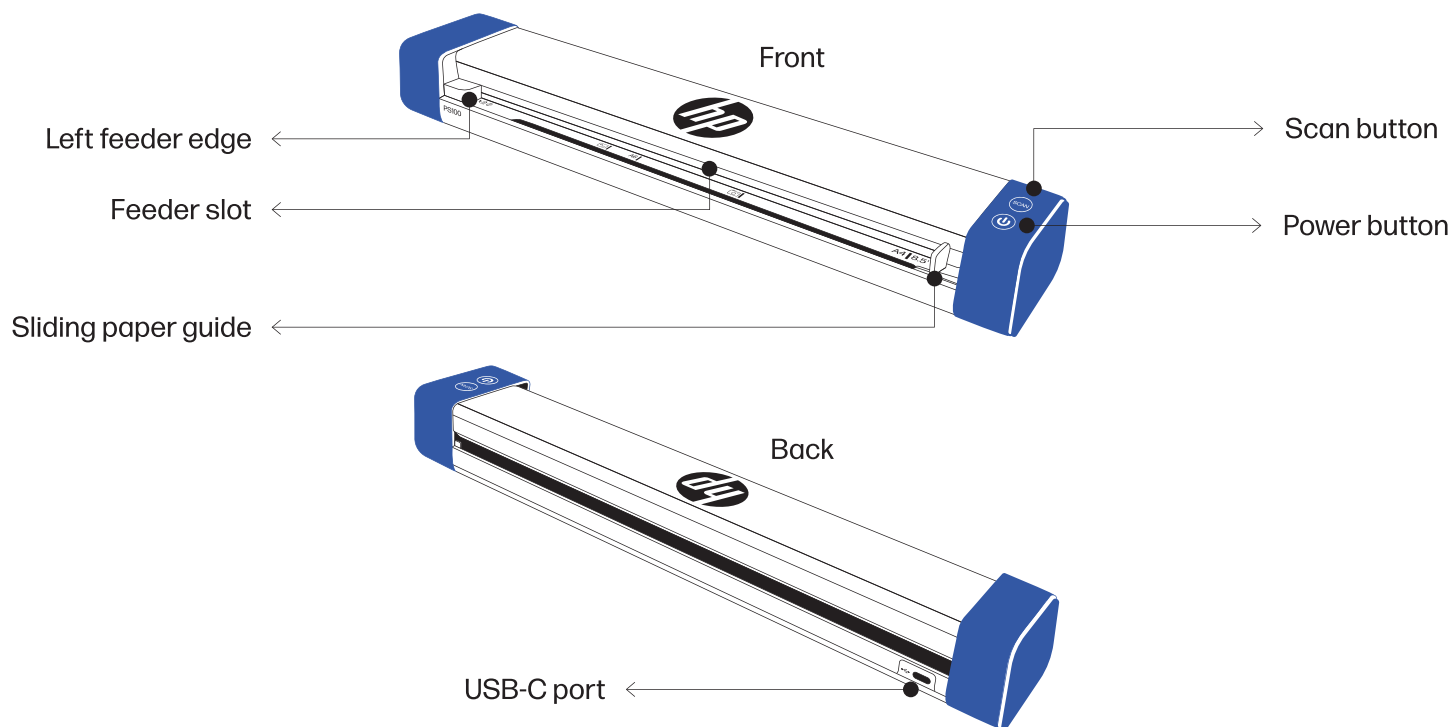

Setup instructions

Placing the scanner

Install the scanner in a location that meets the following conditions:

- Allow sufficient space around the scanner for proper ventilation and paper scanning.
- Do not place objects close to the back or bottom of the scanner, which may hinder air circulation.
- Place on a flat and level surface.
- Avoid humid, dusty environments.

Powering the scanner

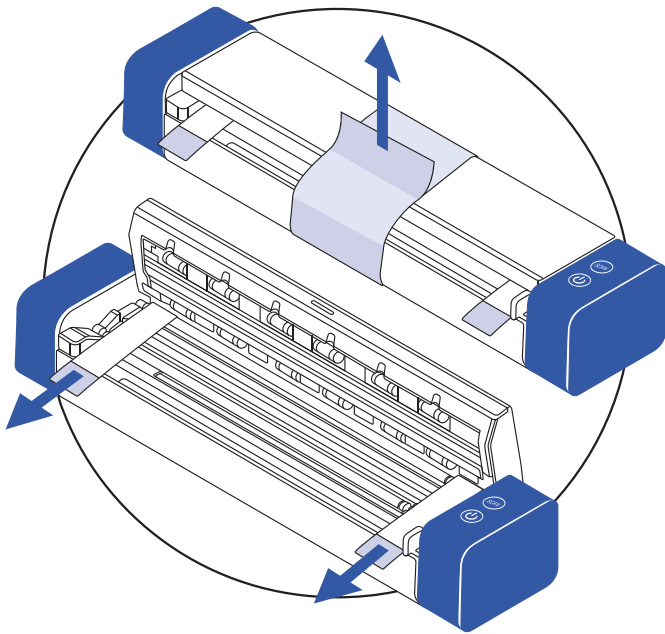

1

Remove protective tape from the scanner and inside the feeder.

2

Connect the scanner to your computer using the USB cable.

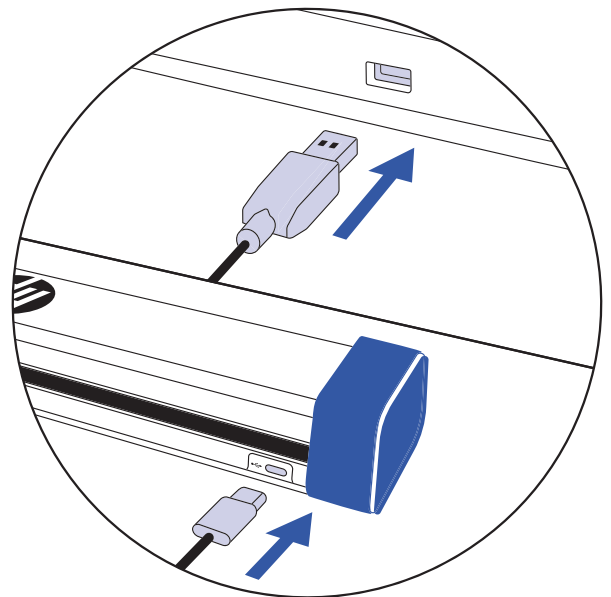

Setup instructions (Continued)

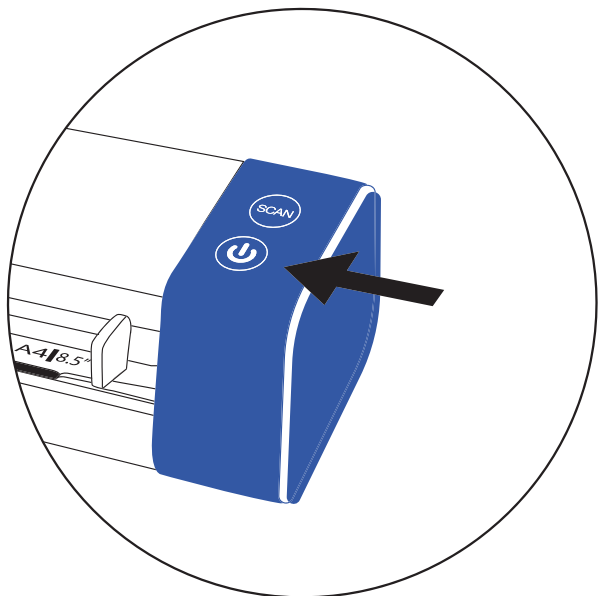

3

Turn on the scanner with the power button.

4

Install the HP WorkScan software at hpworksolutions.com/setup to start using your scanner.

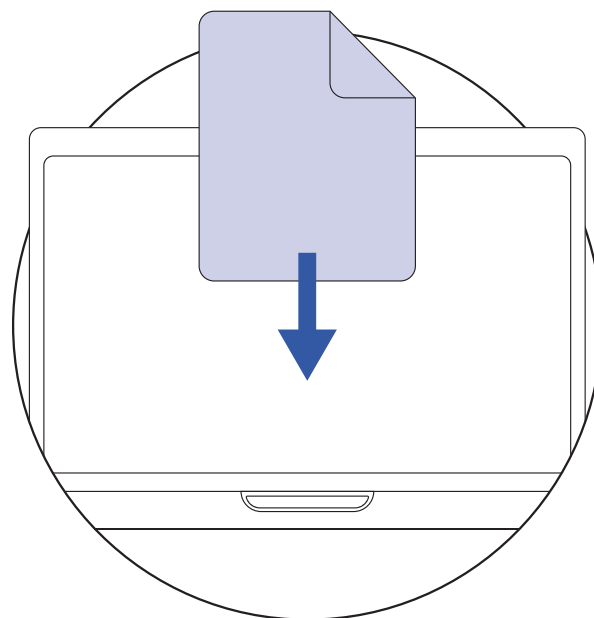

NOTE:

Your computer will not recognize the scanner unless the drivers are installed. The drivers will automatically install themselves when the software is installed. The software must be installed before attempting to connect the scanner.

Operating instructions

Operating the scanner

1

Make sure that the scanner is turned on.

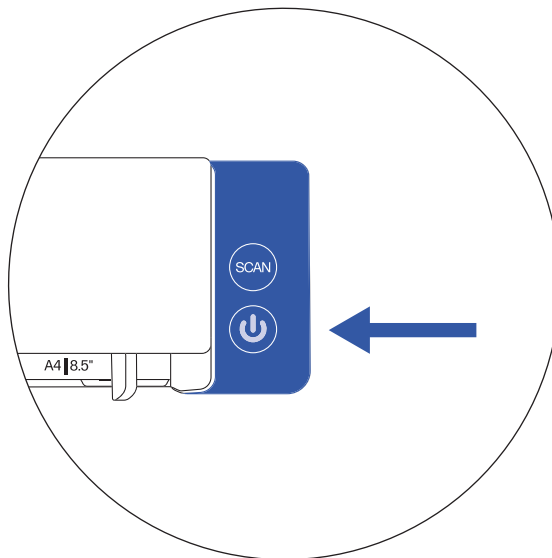

2

Insert your document into the scanner against the left feeder edge. Make sure your document is facing up and the top edge of the document is going into the feeder slot first.

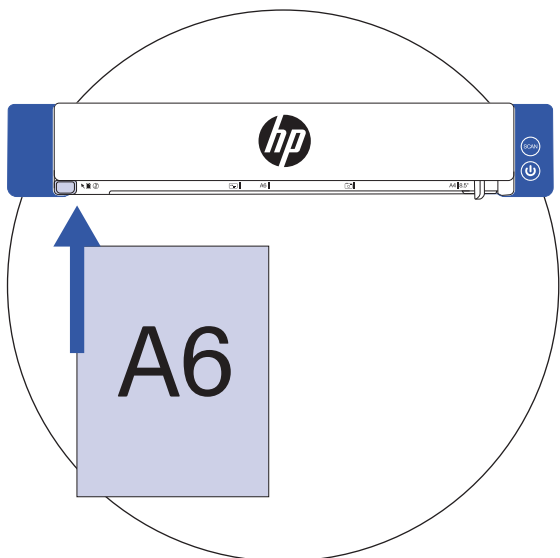

3

Slide the paper guide against the right side of the document.

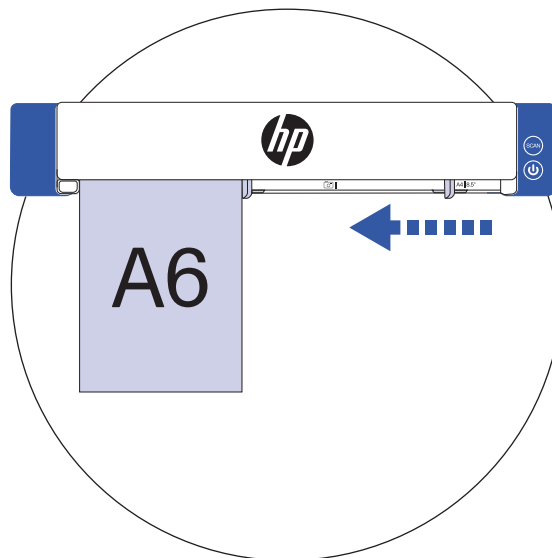

Operating instructions (Continued)

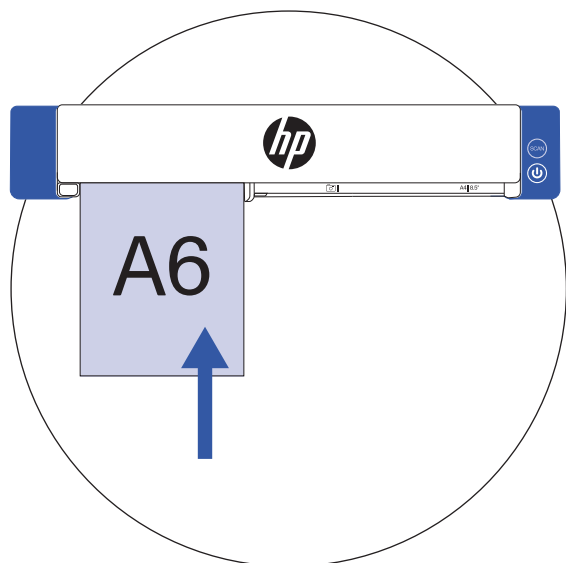

4

Gently push the document into the feeder slot.

NOTE: Your document will start to feed into the scanner and the power button will blink green when the device senses paper.

5

Activate the scan from the software or press the scan button on the scanner.

NOTE: Scan button only works with the HP WorkScan software.

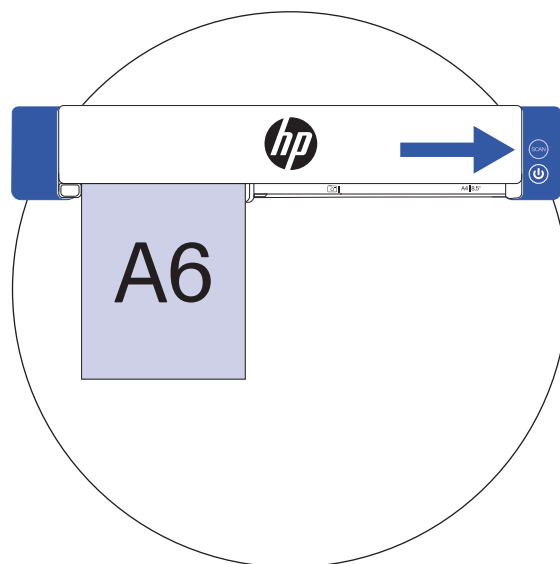

Suitable paper type:

- Photos and documents (3.5" x 5", 4" x 6", 5" x 7", Letter (8.5" x 11"), 8" x 10", A4 (8.3" x 11.7"), 8.5" x 14")
- Plastic cards (standard 3.375" x 2.125" or larger)

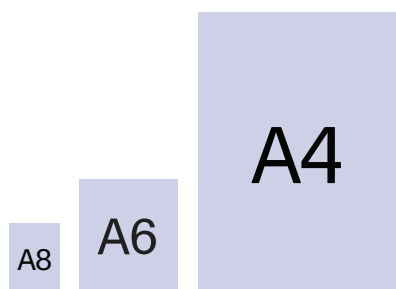



Unsuitable paper type:

- Paper thicker than 0.03"
- Paper with either side shorter than 2.0"
- Printed media (newspapers, magazines, etc.)
- Soft, thin materials
- Paper that's curled or wrinkled
- Paper with staples or paper clips
- Paper with dark colors

Function & LED guide







Button status chart

Use this chart to help you understand what the scanner will do when a button on the device is pressed.

Button	Description / Status	LED color / action
Scan button	The button initiates a scan if the document is detected in the feeder. NOTE: Scan button will only work with HP WorkScan software which can be downloaded at hpworksolution.com/setup .	N/A
Power button	When the button is pressed to power on the scanner.	 Blinking green
	When the scanner is ready to scan or in the process of scanning	 Solid green
	When the button is pressed and held for 5 seconds to power off the scanner.	 ^{x5} Blinking green (5 times)

Scanner status LED chart

Use this chart to help you understand what the LED indicator means when the scanner is in a certain state.

State	Description / Status	LED color / action
USB connecting	Allow the scanner to connect to the USB.	 Blinking green
USB connected	Connection with the computer is established.	 Solid green
Calibration	The scanner is unable to scan documents at this time.	 Blinking green
Calibration failure	Something went wrong. Try calibrating again.	 ^{10s} Fast blinking red for 10 seconds
Paper jam	Open the scanner and remove the jam.	 Blinking red
Cover open	Close the cover properly.	 Blinking red
Paper detection	Paper insertion into the initially empty feeder.	 ^{x3} Fast blinking green (3 times)

HP WorkScan overview

To use HP WorkScan, download the Windows or Mac version of the HP WorkScan software to your computer at hpworksolutions.com/setup. Then, follow the instructions that appear on your screen to install the software. Once you open the software, the main layout will appear:

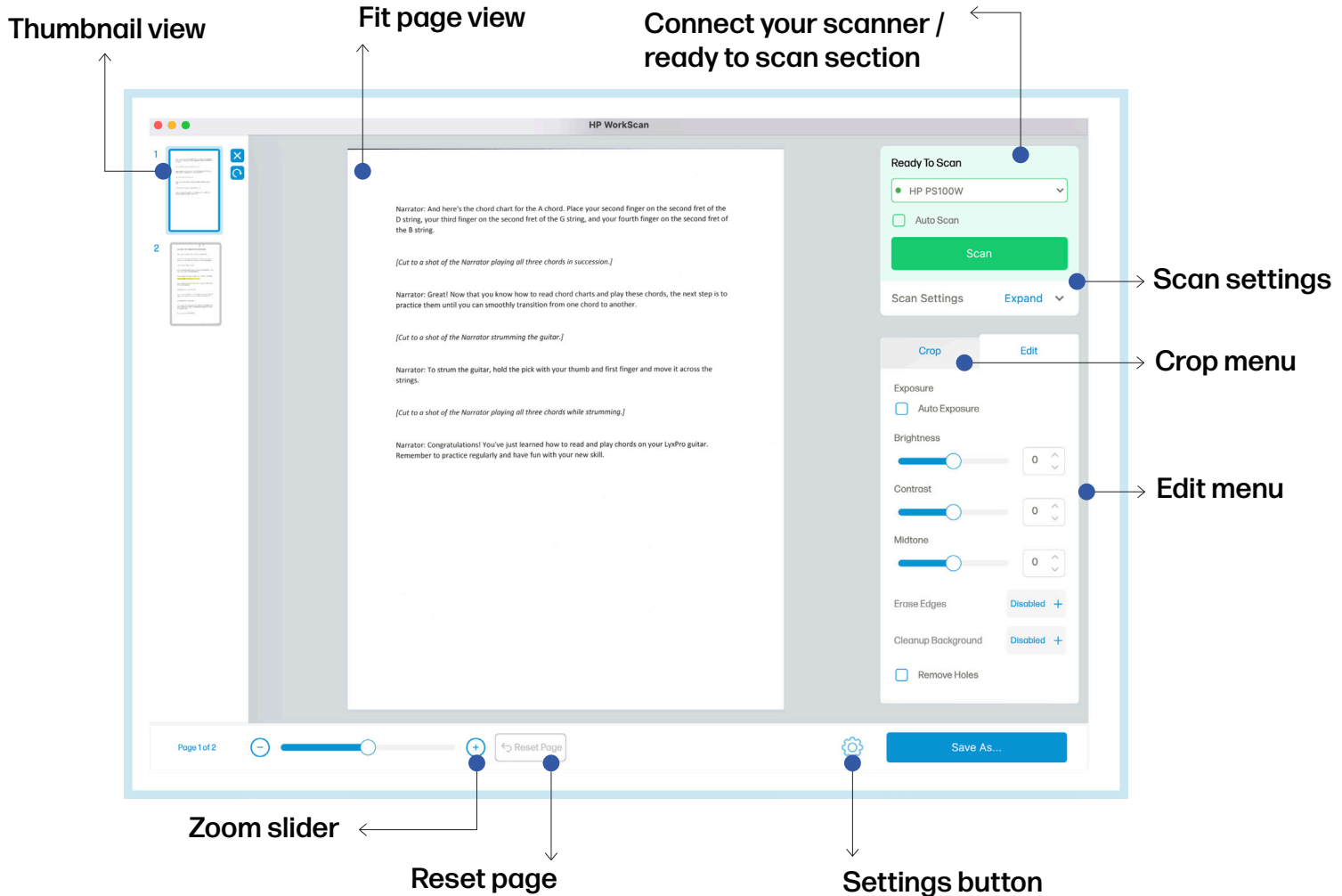

Thumbnail view

The Thumbnail view allows you to select and view other pages that were scanned in more detail.

Two buttons will appear once a page in the Thumbnail view is selected or highlighted over. Click the X button to delete the selected page. Click the rotate button to rotate the selected page 90° clockwise.

NOTE:

The X and rotate buttons will not appear if the window size of the software is too small.

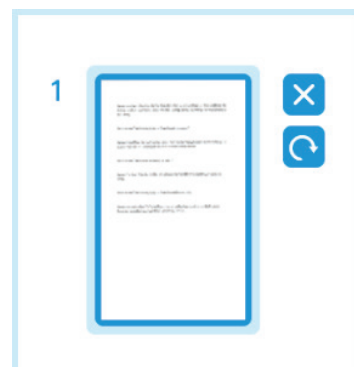

HP WorkScan overview (Continued)

Fit page view

The Fit page view allows you to zoom in and out and preview the main page you are working on. This is the view you would use to crop or edit the selected page.

Connect your scanner/ready to scan section

The “Connect your scanner/ready to scan” section is where you would get started. For this model, you can connect the scanner via USB.

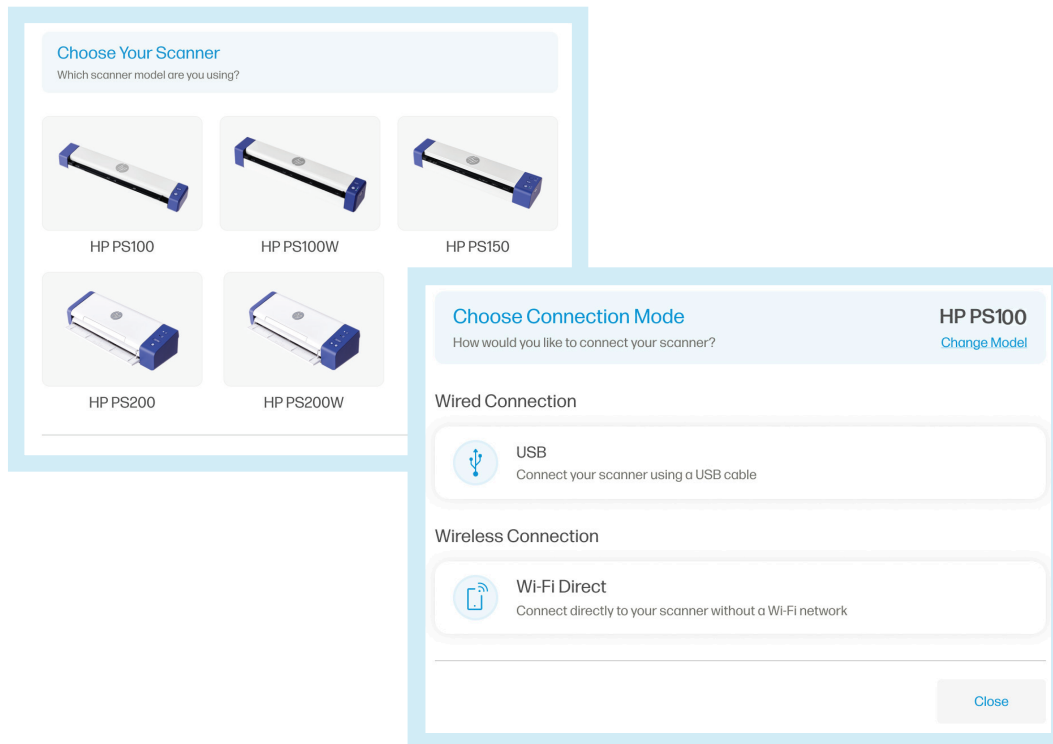

Scan settings

The Scan settings allow you to adjust settings such as one-sided scanning, color mode, resolution, and input page size.

Click “Expand” to expand the dropdown menu of the scan settings. Click “Collapse” to retract the menu. Click “See all” to see the scan settings menu in full where you will find additional options like page orientation or item.

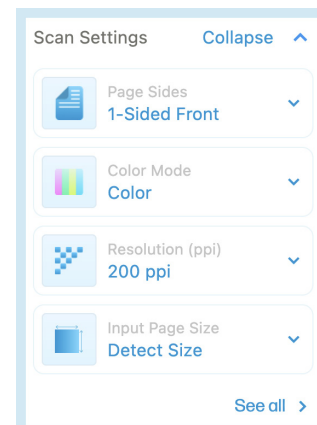

HP WorkScan overview (Continued)

Scan settings (Continued)

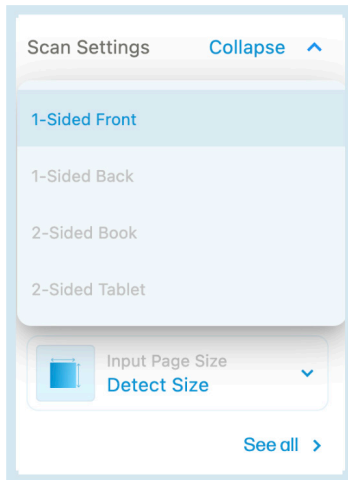

Page Sides

Page sides dropdown allows you to choose between 1-sided front, 1-sided back, 2-sided book, and 2-sided tablet. (Since the PS100 model only does single-sided scans, you can only select the 1-sided front option.)

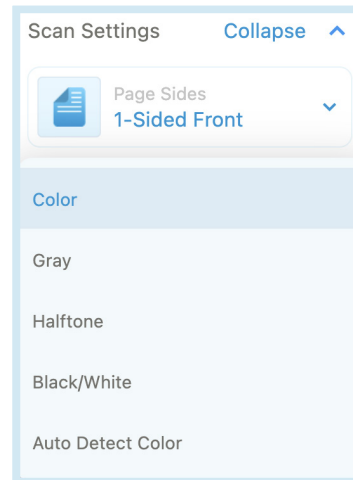

Color Mode

Color mode dropdown allows you to change the color mode of your document between color, gray, halftone, black/white, or auto detect color.

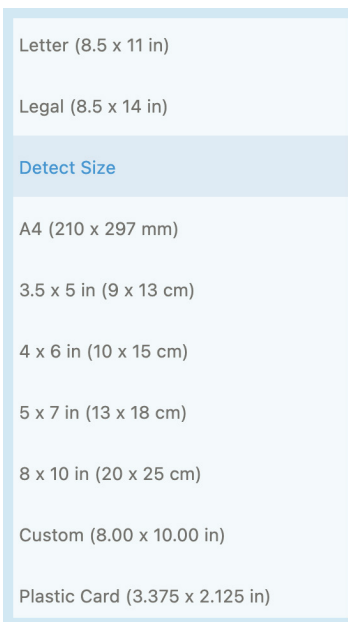

Input Page Size

Input page size dropdown allows you to change the size of your scanned document. You can select between letter size, legal size, detect size, A4, 3.5 x 5 in, 4 x 6 in, 5 x 7 in, 8 x 10 in, custom, or plastic card size.

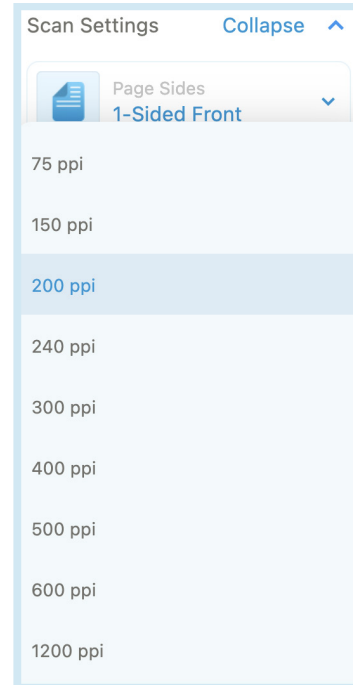

Resolution (ppi)

Resolution (ppi) dropdown allows you to change the resolution of your scanned document. You can select between 75, 150, 200, 240, 300, 400, 500, 600, or 1200 ppi.

NOTE:

Detect size will automatically detect the size of the document you are scanning. Custom allows you to set your own measurements for the scanned document.

HP WorkScan overview (Continued)

Edit menu

The Edit menu allows you to adjust the brightness, contrast, midtone, and so on of your scanned document.

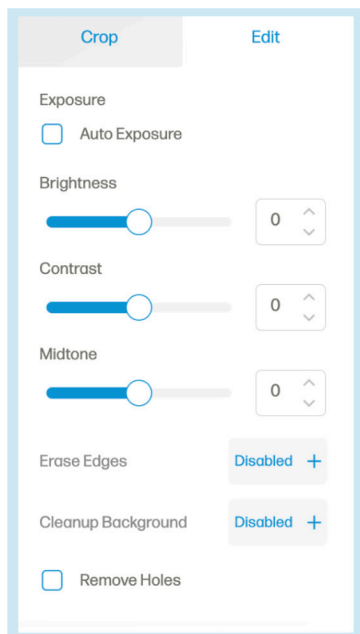

Click the “Auto Exposure” checkbox to automatically optimize the exposure of an image.



Use the brightness slider or selector to lower or raise the brightness of the selected page.



Use the contrast slider or selector to lower or raise the contrast of the selected page.



Use the midtone slider or selector to lower or raise the midtone of the selected page.

The Erase Edges option allows you to enable or disable the deletion of the edges on the selected page.

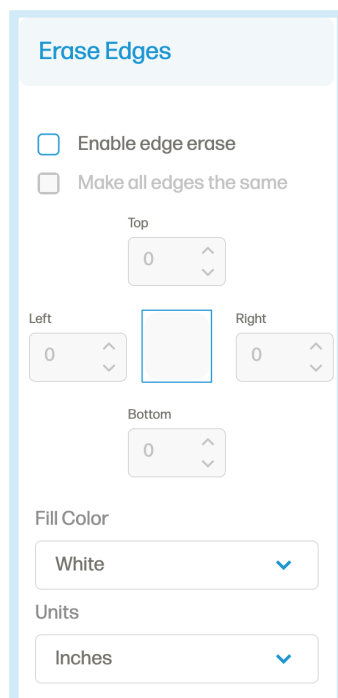

Click the “Enable edge erase” checkbox to unlock the option to erase edges. Customize how much of the edge you erase from each side using the directional selectors. Or click the “Make all edges the same” checkbox to change all the sides with the same measurement all at once.

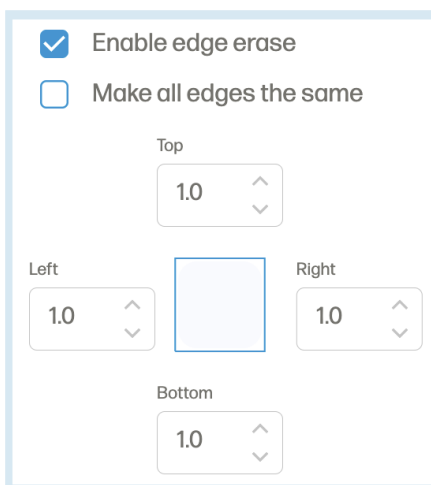

HP WorkScan overview (Continued)

Edit menu (Continued)

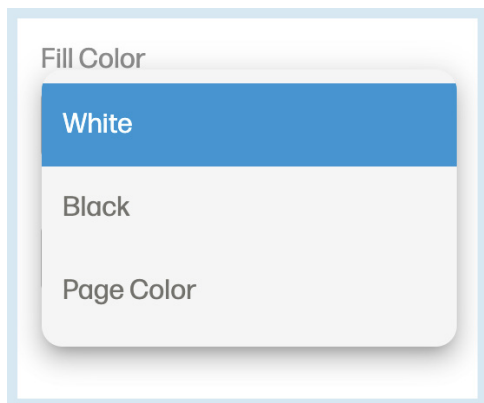

Use the Fill color dropdown to select the color the erased edges are replaced with between white, black, or page color.

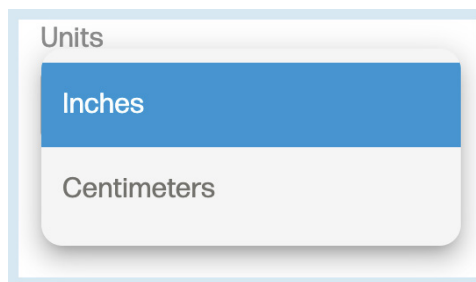

Use the Units dropdown to change the unit of measurements used to erase the edges of the selected page.

The Cleanup Background option allows you to enable or disable the background cleanup of the selected page.

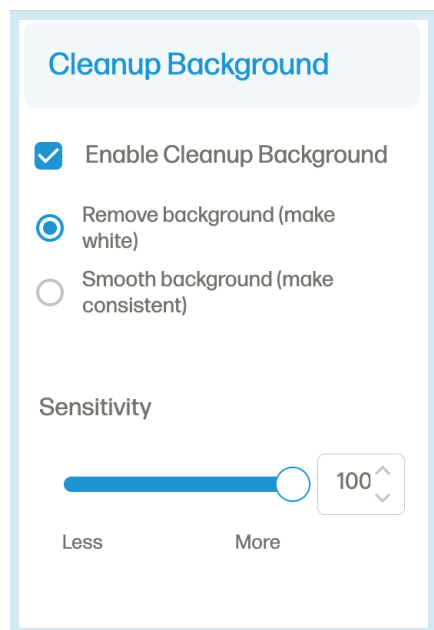

Click the "Enable Cleanup Background" checkbox to unlock other options. Select "Remove background" to make the background white or select "Smooth background" to make the background a consistent color with the rest of the selected page.

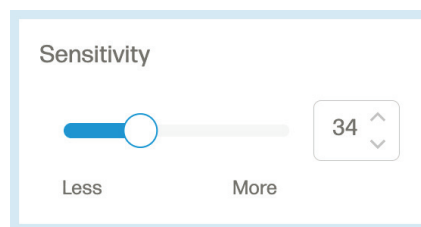

Use the sensitivity slider or selector to adjust the sensitivity of the background cleanup.

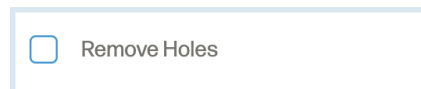

Click the "Remove Holes" checkbox to remove holes in the selected page.

Once you have made your changes, click the "Apply" button to apply your changes.

HP WorkScan overview (Continued)

Crop menu

The Crop menu allows you to crop or rotate the selected page.

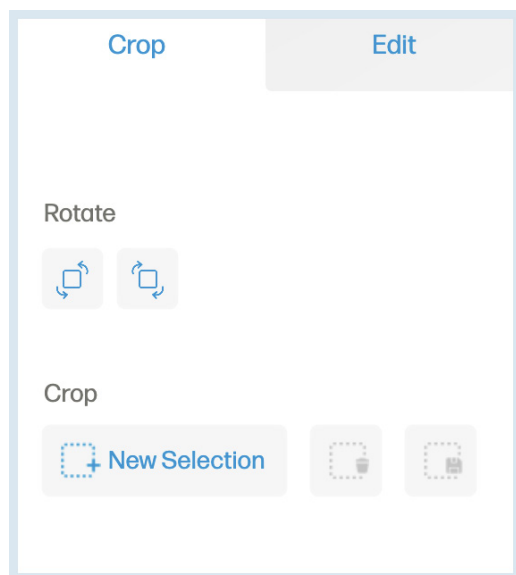

Use the Rotate section to rotate the selected page either 90° clockwise or 90° counterclockwise.

Rotate



Use the Crop section to make a selection and adjust the selection you made.

Crop



Click the “New selection” option to select an area on your scan to edit. Click the Delete selection option to white out the area selected. Click the “Save selection” option to confirm the cropping of the selected area. Click the “Cancel” option to remove the current selection.

Crop

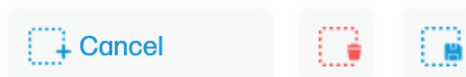

Settings button

The Settings button brings you to an additional settings menu to view scan settings, device settings, the about section, and the support page.

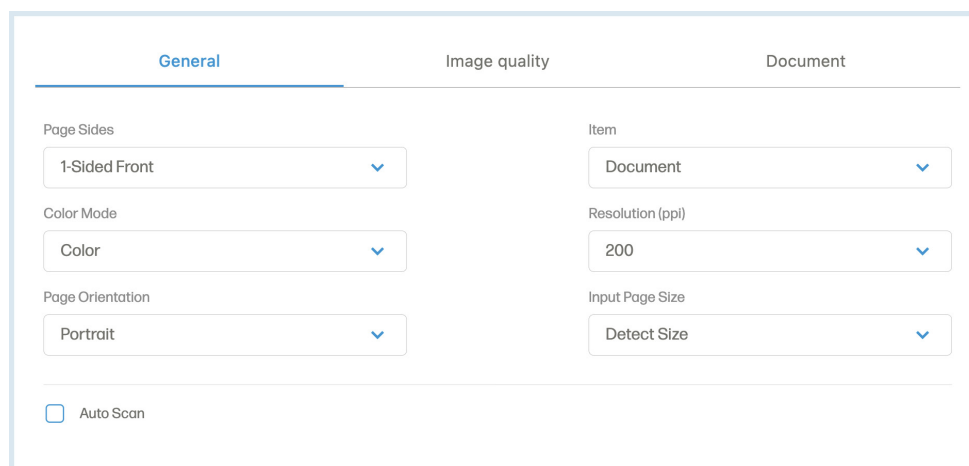

HP WorkScan overview (Continued)

Settings button (Continued)

In the full Scan settings menu, you will find the General tab with options like page sides, color mode, page orientation, item, resolution (ppi), and input page size.

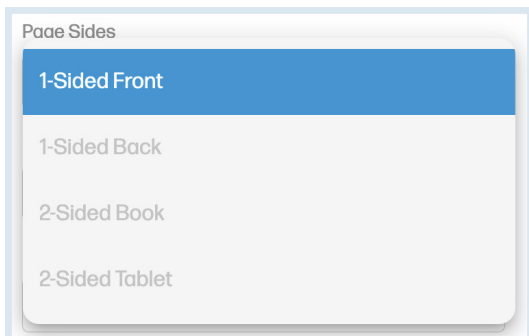

Page sides dropdown allows you to choose between 1-sided front, 1-sided back, 2-sided book, and 2-sided tablet. (Since the PS100 model only does single-sided scans, you can only select the 1-sided front option.)

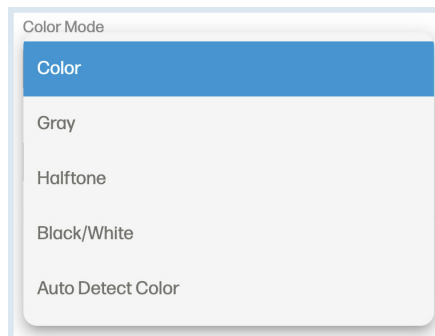

Color mode dropdown allows you to change the color mode of your document between color, gray, halftone, black/white, or auto detect color.

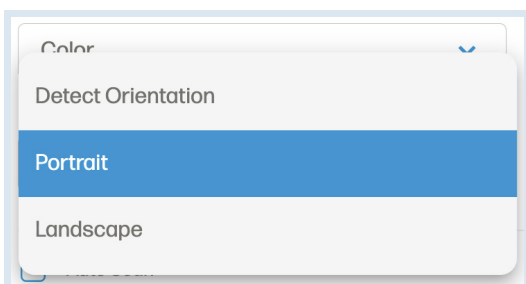

The Page orientation dropdown allows you to change the orientation of the selected page between detect orientation, portrait, or landscape.

NOTE:

Detect orientation allows the software to adjust the orientation of the selected page based on the layout of the document.

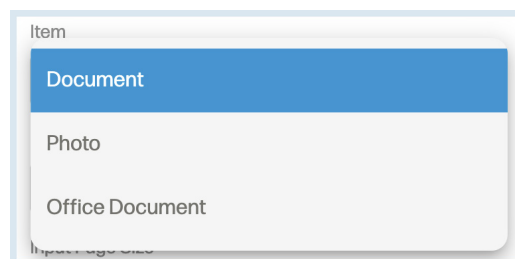

The Item dropdown allows you to select the paper type of the selected page between document, photo, or office document.

HP WorkScan overview (Continued)

Settings button (Continued)

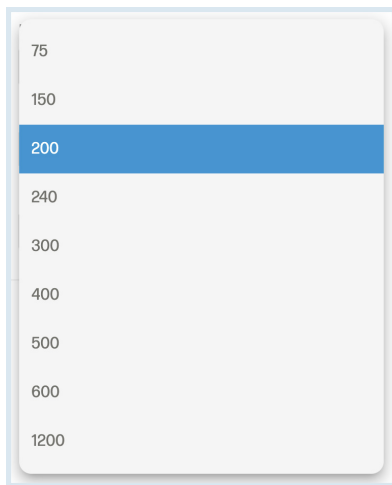

Resolution (ppi) dropdown allows you to change the resolution of your scanned document. You can select between 75, 150, 200, 240, 300, 400, 500, 600, or 1200 pp.

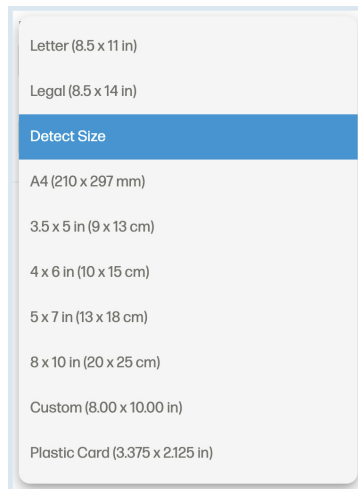

Input page size dropdown allows you to change the size of your scanned document. You can select between letter size, legal size, detect size, A4, 3.5 x 5 in, 4 x 6 in, 5 x 7 in, 8 x 10 in, custom, or plastic card size.

Auto scan allows you to load your document into the feeder and it will automatically scan. After you have completed all your scans, click the "Stop Auto Scan" button.



In the Image quality tab, you can adjust the exposure for color and gray.

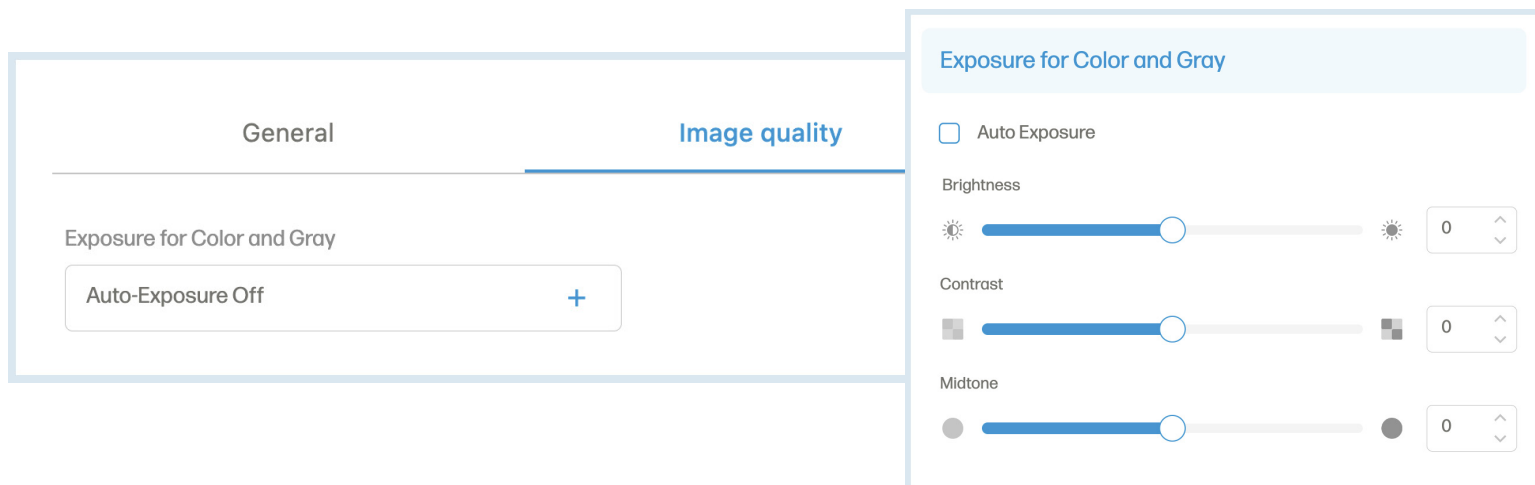

HP WorkScan overview (Continued)

Settings button (Continued)

In the Document tab, you can find options like erase edges, cleanup background, and remove hole.

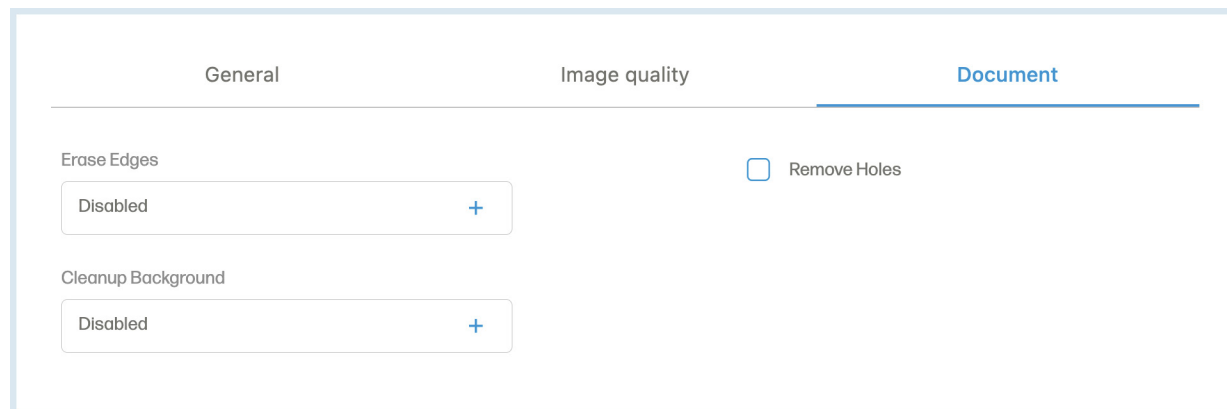

Click the “Device settings” option from the sidebar. In the Device settings menu, you can view or remove the selected scanner or start the calibration process.

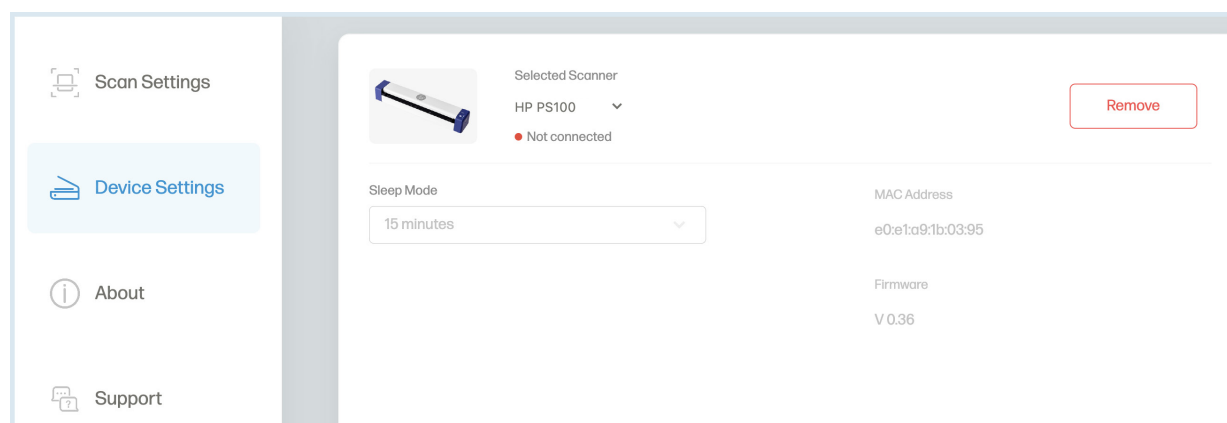

Click the “About” option from the sidebar. In the About menu, you can view the End User License Agreement or Legal & Privacy.

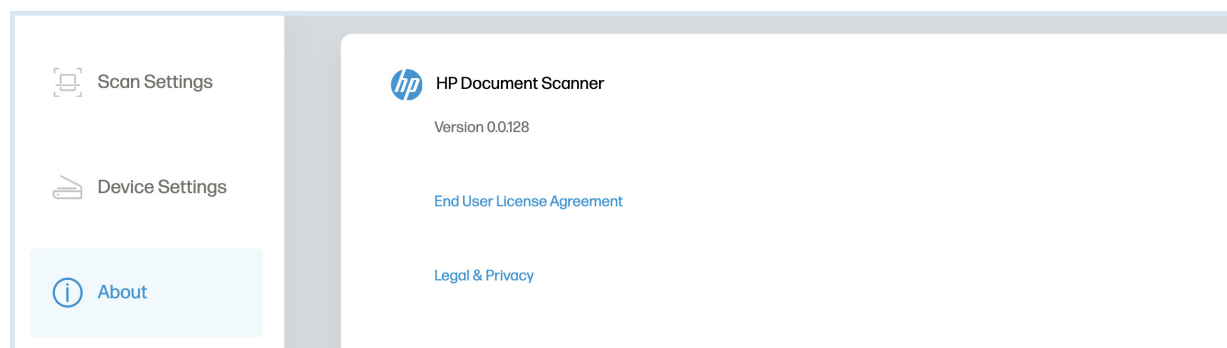

Click the “Support” option from the sidebar. In the Support menu, you will find the support page link and contact information for assistance.

HP WorkScan overview (Continued)

Zoom slider

The zoom slider is used to zoom in or out on the current document. You can also use the plus and minus buttons to zoom as well.

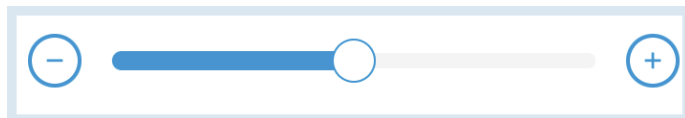

Reset page

The Reset page button clears all the edits made to the current document and does not affect other documents.



Save / save as button

The Save/save as button allows you to save your scanned document.

NOTE:

When the Save as dialogue box appears, the save as type dropdown box will be set to PDF by default. Use the dropdown to change how you want your file to save as.



Scan button

The Scan button is used to initiate a scan when the paper is detected near the feeder of the scanner.

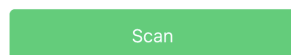

Auto scan checkbox

Auto scan allows you to load your document into the feeder and it will automatically scan. After you have completed all your scans, click the "Stop Auto Scan" button.



New scans

In order to start a new set of scanned documents that won't be added to the same set of previously scanned documents, you must exit out of the software and start it up again.

Care and maintenance

Calibrating the scanner

Calibration is done to ensure that the scanner scans your documents properly.

1. Turn on the scanner.
 2. Click the Settings button, select the "Device Settings" option, and click the Calibrate button.
An "Insert calibration sheet" dialog box will appear.
 3. Insert the included calibration sheet into the scanner with the text facing up. Let the white area of the sheet feed into the scanner first.
 4. Click the "OK" button in the dialog box to start the calibration. After the calibration process is finished, continue with normal operations.
 5. If the calibration fails, restart the scanner and try the process over again.
-

Cleaning the scanner

1. Turn off and unplug the scanner.
2. Open the scanner cover. To open the cover, lift up the top portion of the feeder.
3. Wipe the glass and feeding rollers in the scanner with a cleaning cloth.

NOTE:

Do not use any solvents or corrosive liquid to clean any parts of the scanner.

Scanner operation pro tips

- Only calibrate the scanner when the scanner hasn't been used recently, scanned images are fuzzy, or color looks inaccurate.
- Make sure your documents are free of staples, paper clips, or other debris that may mess up the scan.
- Do not push your document into the scanner during operation.
- Avoid scanning certain materials. (Ex. wrinkled material, cloth, newspapers, or magazines.)
- Keep the included calibration sheet away from dust and debris.
- Clean the scanner after 200 scans or if vertical lines or stripes appear on the scanned images.

Troubleshooting

Problem	Solution
Paper jam	Remove the paper and restart the scanner. To remove paper, the scanner cover must be opened. To open the cover, lift up the top portion of the feeder. The scanner cover should only be opened for cleaning and removing paper jams.
Cover open	Close the cover properly and restart the scanner. To close the cover, press down on the top portion of the feeder until the cover clicks in place.
Calibrations fails	Recalibrate and restart the scanner.

For more information



To watch a quick setup video or to learn more about your HP Mobile Scanner, please visit www.hpworksolutions.com/setup or scan the QR code:



Need help?

Get in touch with our knowledgeable customer service team by accessing our live chat at www.hpworksolutions.com, emailing us at support@hpworksolutions.com, or calling 1-877-424-9746.

Specifications

Product type: Paper scanner

Dimensions (W x H x D): 11.4" x 1.4" x 2"

Net weight: 0.8 lbs.

Image technology: Contact Image Sensor (CIS)

Scan speed: 15 ppm

Resolution: 1200 dpi

Scanning modes (color): Black & white/gray/color

Scanning modes: Simplex (single-sided scan)

Feed modes: Single feed

Max. paper size (W x L): 8.5" x 14"

Min. paper size (W x L): 2" x 2.9"

Paper weight: 1.77 ~ 3.16 oz/yd² (60 ~ 107 g/m²)

ID card thickness: Up to 0.03" (0.8 mm)

Interface: USB type-C port

USB power: 5 V DC, 500 mA

Operating systems: macOS, Windows

Operating temperature: 50 °F ~ 95 °F (10 °C ~ 35 °C)

Humidity: 15% ~ 85% RH

Connectivity: USB-C

Number of scans per charge: 200

Power source required: Yes (plug-in power)

Power source: USB cable (included)

Installation required: Yes (connect to computer)

Adult assembly required: No

Additional tools required: No

Country of origin: China

Warranty included: Yes

Warranty length: 2 years

Warranty

LIMITED WARRANTY TO ORIGINAL CONSUMER

This HP Mobile Scanner (“Product”), including any accessories included in the original packaging, as supplied and distributed new by an authorized retailer is warranted by C&A Marketing, Inc. (the “Company”) to the original consumer purchaser only, against certain defects in material and workmanship (“Warranty”) as follows:

To receive Warranty service, the original consumer purchaser must contact the Company or its authorized service provider for problem determination and service procedures. Proof of purchase in the form of a bill of sale or receipted invoice, evidencing that the Product is within the applicable Warranty period(s), MUST be presented to the Company or its authorized service provider in order to obtain the requested service.

Service options, parts availability, and response times may vary and may change at any time. In accordance with applicable law, the Company may require that you furnish additional documents and/or comply with registration requirements before receiving warranty service. Please contact our customer service for details on obtaining warranty service:

Email: support@hpworksolutions.com

Phone: 1-877-424-9746

Shipping expenses to the Company’s Return Facility are not covered by this warranty, and must be paid by the consumer. The consumer likewise bears all risk of loss or further damage to the Product until delivery to said facility.

EXCLUSIONS AND LIMITATIONS The Company warrants the Product against defects in materials and workmanship under normal use for a period of TWO (2) YEARS from the date of retail purchase by the original end-user purchaser (“Warranty Period”). If a hardware defect arises and a valid claim is received within the Warranty Period, the Company, at its sole option and to the extent permitted by law, will either (1) repair the Product defect at no charge, using new or refurbished replacement parts, (2) exchange the Product with a Product that is new or which has been manufactured from new or serviceable used parts and is at least functionally equivalent to the original device, or (3) refund the purchase price of the Product.

A replacement Product or part thereof shall enjoy the warranty of the original Product for the remainder of the Warranty Period, or ninety (90) days from the date of replacement or repair, whichever provides you longer protection. When a Product or part is exchanged, any replacement item becomes your property, while the replaced item becomes the Company’s property. Refunds can only be given if the original Product is returned.

This Warranty does not apply to:

- (a) Any non-HP Mobile Scanner product, hardware or software, even if packaged or sold with the Product;
- (b) Damage caused by use with non-HP Mobile Scanner products;
- (c) Damage caused by accident, abuse, misuse, flood, fire, earthquake, or other external causes;
- (d) Damage caused by operating the Product outside the permitted or intended uses described by the Company;
- (e) Damage caused by third-party services;
- (f) A Product or part that has been modified to alter functionality or capability without the written permission of the Company;
- (g) Consumable parts, such as batteries, fuses, and bulbs;
- (h) Cosmetic damage; or
- (i) If any HP Mobile Scanner serial number has been removed or defaced.

Warranty (Continued)

This Warranty is valid only in the country where the consumer purchased the Product, and only applies to Products purchased and serviced in that country.

The Company does not warrant that the operation of the Product will be uninterrupted or error-free. The Company is not responsible for damage arising from your failure to follow instructions relating to its use.

NOTWITHSTANDING ANYTHING TO THE CONTRARY AND TO THE MAXIMUM EXTENT PERMITTED BY APPLICABLE LAW, THE COMPANY PROVIDES THE PRODUCT "AS-IS" AND "AS-AVAILABLE" FOR YOUR CONVENIENCE AND THE COMPANY AND ITS LICENSORS AND SUPPLIERS EXPRESSLY DISCLAIM ALL WARRANTIES AND CONDITIONS, WHETHER EXPRESSED, IMPLIED, OR STATUTORY, INCLUDING THE WARRANTIES OF MERCHANTABILITY, FITNESS FOR A PARTICULAR PURPOSE, TITLE, QUIET ENJOYMENT, ACCURACY, AND NON-INFRINGEMENT OF THIRD-PARTY RIGHTS. THE COMPANY DOES NOT GUARANTEE ANY SPECIFIC RESULTS FROM THE USE OF THE PRODUCT, OR THAT THE COMPANY WILL CONTINUE TO OFFER OR MAKE AVAILABLE THE PRODUCT FOR ANY PARTICULAR LENGTH OF TIME. THE COMPANY FURTHER DISCLAIMS ALL WARRANTIES AFTER THE EXPRESS WARRANTY PERIOD STATED ABOVE.

YOU USE THE PRODUCT AT YOUR OWN DISCRETION AND RISK. YOU WILL BE SOLELY RESPONSIBLE FOR (AND THE COMPANY DISCLAIMS) ANY AND ALL LOSS, LIABILITY, OR DAMAGES RESULTING FROM YOUR USE OF THE PRODUCT.

NO ADVICE OR INFORMATION, WHETHER ORAL OR WRITTEN, OBTAINED BY YOU FROM THE COMPANY OR THROUGH ITS AUTHORIZED SERVICE PROVIDERS SHALL CREATE ANY WARRANTY.

IN NO EVENT WILL THE COMPANY'S TOTAL CUMULATIVE LIABILITY ARISING FROM OR RELATED TO THE PRODUCT, WHETHER IN CONTRACT OR TORT OR OTHERWISE EXCEED THE FEES ACTUALLY PAID BY YOU TO THE COMPANY OR ANY OF ITS AUTHORIZED RESELLERS FOR THE PRODUCT AT ISSUE IN THE LAST YEAR FROM YOUR PURCHASE. THIS LIMITATION IS CUMULATIVE AND WILL NOT BE INCREASED BY THE EXISTENCE OF MORE THAN ONE INCIDENT OR CLAIM. THE COMPANY DISCLAIMS ALL LIABILITY OF ANY KIND OF ITS LICENSORS AND SUPPLIERS. IN NO EVENT WILL THE COMPANY OR ITS LICENSORS, MANUFACTURERS, AND SUPPLIERS BE LIABLE FOR ANY INCIDENTAL, DIRECT, INDIRECT, SPECIAL, PUNITIVE, OR CONSEQUENTIAL DAMAGES (SUCH AS, BUT NOT LIMITED TO, DAMAGES FOR LOSS OF PROFITS, BUSINESS, SAVINGS, DATA, OR RECORDS) CAUSED BY THE USE, MISUSE, OR INABILITY TO USE THE PRODUCT.

Nothing in these terms shall attempt to exclude liability that cannot be excluded under applicable law. Some countries, states, or provinces do not allow the exclusion or limitation of incidental or consequential damages or allow limitations on warranties, so certain limitations or exclusions may not apply to you. This warranty gives you specific legal rights, and you may have other rights that vary from state to state or province to province. Contact your authorized retailer to determine if another warranty applies.

FCC Statement

The United States Federal Communications Commission (in 47 CFR 15.105) has specified that the following notice be brought to the attention of users of this product, HP Mobile Scanner PS100.

This equipment has been tested and found to comply with the limits for a Class B digital device, pursuant to Part 15 of the FCC Rules. These limits are designed to provide reasonable protection against harmful interference in a residential installation. This equipment generates, uses, and can radiate radio frequency energy and, if not installed and used in accordance with the instructions, may cause harmful interference to radio communications. However, there is no guarantee that interference will not occur in a particular installation. If this equipment does cause harmful interference to radio or television reception, which can be determined by turning the equipment off and on, the user is encouraged to try to correct the interference by one or more of the following measures:

- Reorient or relocate the receiving antenna.
- Increase the separation between the equipment and receiver.
- Connect the equipment into an outlet on a circuit different from that to which the receiver is connected.
- Consult the dealer or an experienced radio/TV technician for help.

This device complies with Part 15 of the FCC Rules. Operation is subject to the following two conditions: (1) this device may not cause harmful interference, and (2) this device must accept any interference received, including interference that may cause undesired operation.

Modifications (part 15.21)

Any changes or modifications made to this device that are not expressly approved by C&A Marketing may void the user's authority to operate the equipment.

For further information, contact:

C+A Global

114 Tivad Lane East, Edison, NJ 08837

Email: support@hpworksolutions.com

Telephone: 1-877-424-9746

Website: www.hpworksolutions.com

