

HP Label Printer

Quick start guide



Innovation you can trust.



To view the full manual with more
instructions, scan the QR code.

Product overview

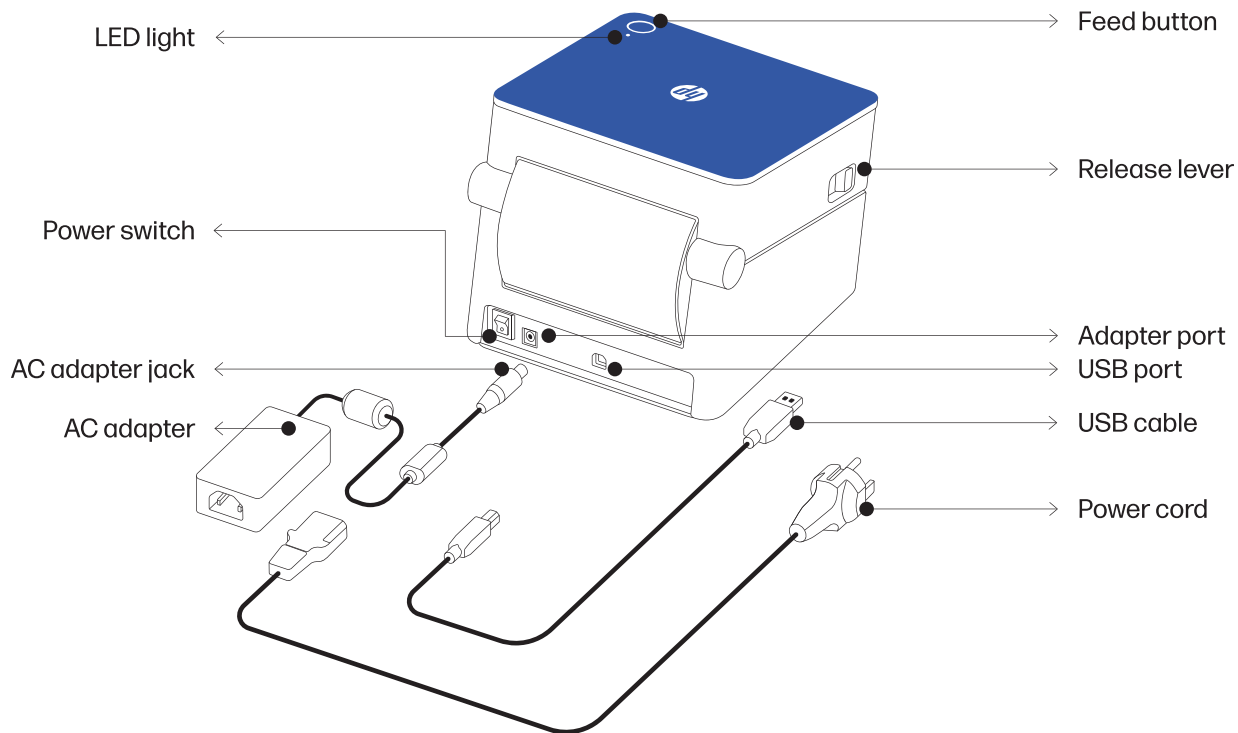

Set up instructions

Powering the printer

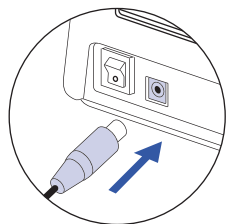

1

First, connect the AC adapter jack to the printer adapter port.

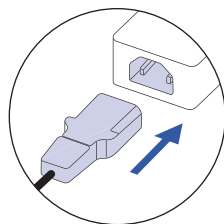

2

Connect the power cord to the AC adapter.

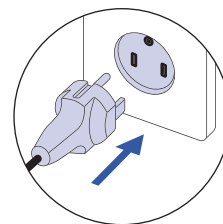

3

Connect the power cord to a power source or outlet.

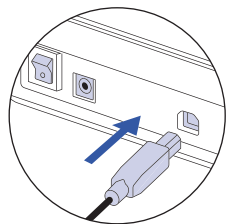

4

Connect the USB cable to the back of the label printer.

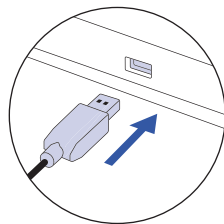

5

Connect the other end of the USB cable to a PC or Mac computer.

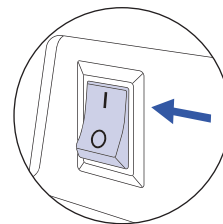

6

Turn on the printer with the power switch.

Loading the labels

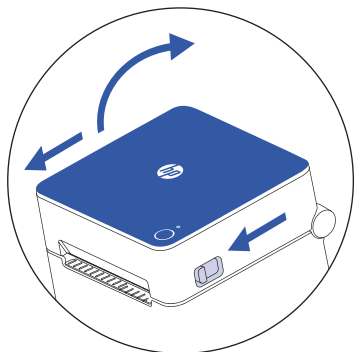

1

Press on both release levers on the sides of the printer to unlock the printer cover.

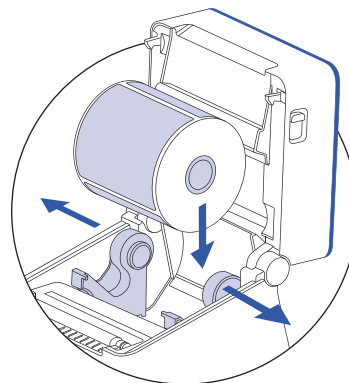

2

Lift the printer cover and insert a roll of labels between the media holders.

NOTE: Make sure the printing side of the label is facing up when installing the label roll.

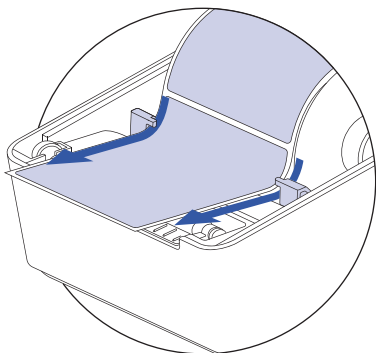

3

Feed the end of the label roll under the two media holder guides in the printer before placing the end of the roll on the printing slot. Then, close the printer cover.

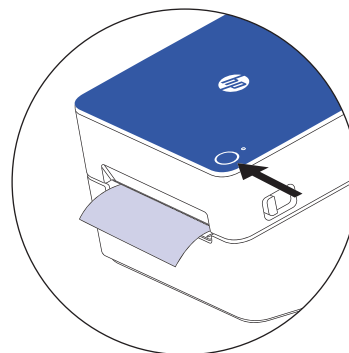

4

Once printer cover is closed label should align on its own. If it doesn't, press the feed button to align the label.

NOTE: By default, most platforms are preset to 8.5" x 11" labels. Make sure to adjust your label size accordingly based on your printing needs.

Installing the driver

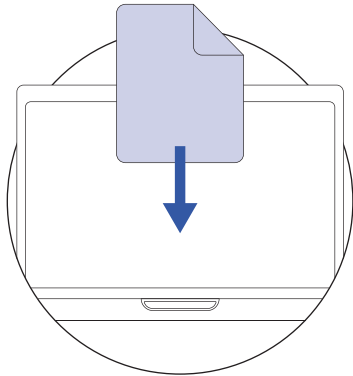





1

Install the driver for Mac or PC at hpworksolutions.com/setup to start using your printer.







Pro tips

- Avoid using poor quality labels as they can damage the printer.
 - Regularly clean the printer head.
 - Press the feed button on the printer to skip a blank label.
 - If paper is jammed, turn off the printer and allow the printer head to cool down.
 - Open the cover and ensure that the rubber is clean. For cleaning, use an alcohol swab then wait for the area to dry before turning on the printer.
- *See page 8 for more on maintenance.

Feed button action guide

Function	Action	LED color
Label Feed Test/ Label Alignment	Press the feed button once to align the label roll and make sure label feeds through the printer.	When complete, light will be solid green 
Configuration Page Printing	Press & hold the feed button for 1- 3 seconds to print out a configuration page that will give you information about the printer.	Slow blinking green light 
Manual Printer Calibration (if needed)	Press & hold the feed button for 4 - 6 seconds to calibrate the printer.	Fast blinking green light 
Factory Reset	Press & hold the feed button for 7 - 9 seconds to reset device back to factory settings.	Slow blinking red light 

LED color guide

LED color	Problem	Solution
Yellow solid light 	N/A	Printer is getting ready.
Green solid light 	N/A	Printer is ready to print.
Slow blinking yellow light 	Printer is having trouble with the label or gap sensor may not have recognized media.	Remove the label roll from the printer. Then, carefully insert the label roll back into the printer. Make sure the roll is properly installed in the printer.
Fast blinking yellow light 	Firmware is updating.	Wait for the printer to finish updating.
Red solid light 	Printer cover is open.	Make sure the printer cover is closed fully before you start to print.
Slow blinking red light 	Label is jammed or labels are running low.	Open the printer cover and adjust the labels as needed.

Maintenance

Cleaning printer head

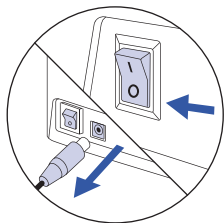

1

Turn the printer off, remove the power cord and AC adapter, and open the cover.

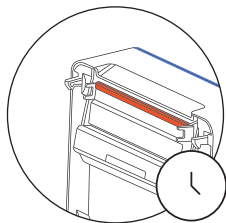

2

Wait until printer head cools down.

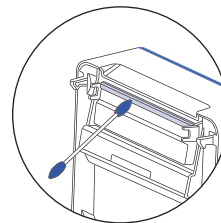

3

Clean printer head using alcohol swab.

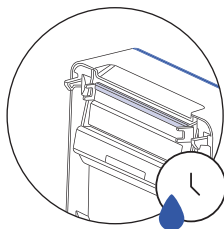

4

Wait until alcohol completely dries before closing the cover.

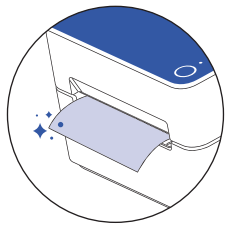

5

Connect the AC adapter and power cord to the printer and print a test page to check that printer head is clean.

Safety precautions

- Please turn off and unplug the printer when it is not in use for long periods of time.
- Use only with the power cord and power adapter supplied with the product.
*Power rating: 24Vdc, 2.5 A
- Do not bend the power cord excessively or place objects on the cord.
- CAUTION: The printer head can become very hot after printing labels.
- Do not touch the printer head.
- Keep the printer out of reach of children and pets.
- Do not use printer if any parts are missing or damaged.
- Do not attempt to disassemble or repair the printer yourself.

For more information



To watch a quick setup video or to learn more about your HP Label Printer, please visit www.hpworksolutions.com/setup or scan the QR code:



To view the two-year limited warranty, please go to: www.hpworksolutions.com



Need help?

Get in touch with our knowledgeable customer service team by accessing our live chat at www.hpworksolutions.com, emailing us at support@hpworksolutions.com, or calling 1-877-424-9746.



HP is a trademark of HP Inc. or its affiliates, used by C&A Marketing, Inc. under license from HP Inc.
Microsoft, Windows, Windows Server, Windows Vista, and Windows 10 are trademarks of Microsoft Corporation in the U.S. and/or other countries.
Apple, AirPrint, iPod, iPhone, iPad, App Store, Mac, Macintosh, and OS X are trademarks of Apple Inc. in the U.S. and other countries.
All other products, brand names, company names, and logos are trademarks of their respective owners, used merely to identify their respective products, and are not meant to connote any sponsorship, endorsement, or approval.
© 2022. All Rights Reserved. Made in Korea.
C&A Marketing, Inc. 114 Tived Lane East, Edison, NJ 08837