

DRJ45-1CAT6

Din Mountable CAT6 protector

Novaris network protection products are designed for the protection of equipment connected to twisted pair network cabling systems. They are compliant with CAT5, CAT6 and CAT6A cabling standards.

The DRJ45-1CAT6 is a single circuit network protector suitable for use on standard DIN mounting rails. LAN cables connect to the front face using standard RJ45 plugs.





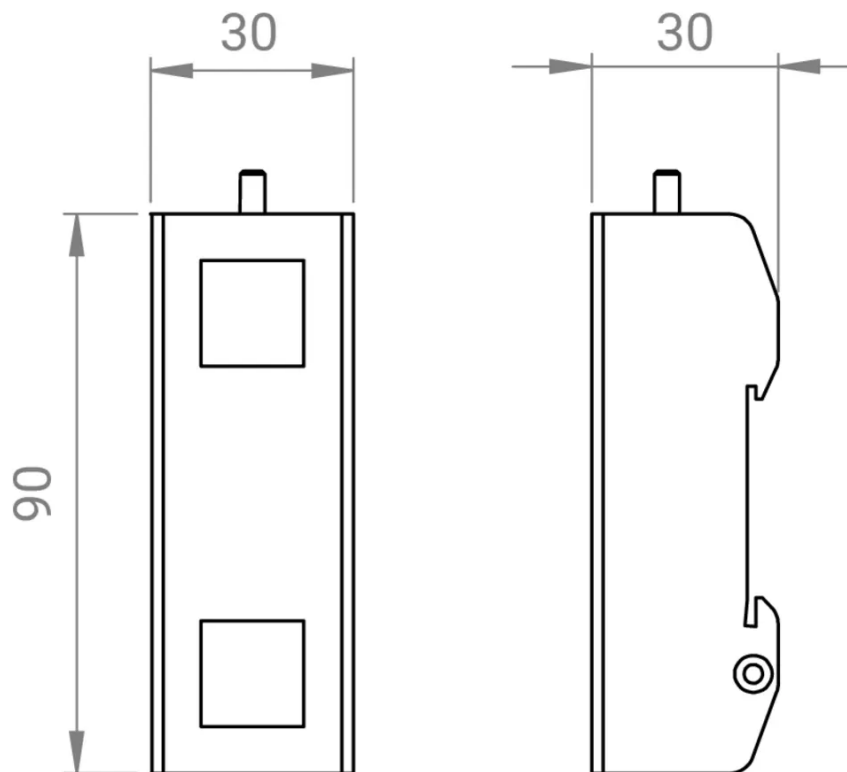

Image for illustrative purposes only

Dimensions



Product Datasheet

Electrical Specifications

Connection type		Series
Number of lines		4 pair & shield
Modes of protection		Transverse & Common
Maximum continuous voltage (DC)	U_c	6V
Maximum continuous voltage (AC)	U_c	4V
Maximum PoE voltage		80VDC
Maximum discharge current (8/20 μ s)	I_{max}	5kA
Maximum common mode discharge current (8/20 μ s)		10kA
Maximum discharge current (10/350 μ s)	I_{imp}	1kA
Maximum common mode discharge current (10/350 μ s)	I_{imp}	2kA
Impulse durability C2 10x8/20 μ s		1.5kA
Impulse durability D1 2x10/350 μ s		0.5kA
Maximum load current	I_L	1A
AC durability 5x1s		1A rms
Overstressed fault mode		Mode 3
Response time	t_A	<5ns
Line resistance		0.1 Ω
Line inductance		0.2 μ H
Earthing		Direct
Attenuation @220MHz		1.7dB
NEXT @250 MHz		35.8dB
Return Loss @ 250MHz		11.2dB

Electrical (L-L) Specifications

Voltage protection level @ 1 kV/ μ s	U_p	20V
Voltage protection level @ 100 V/ s		9V
Capacitance	- +	8pF











Electrical (L-PE) Specifications

Voltage protection level @ 1 kV/ μ s	U_p	<350V
L-PE Voltage protection level @ 1.5 kA 8/20 μ s		500V
Voltage protection level @ 100 V/ s		230V
Capacitance	- +	<2pF

Standard Specifications

IEC 61643-21	SPD connected to telecommunications and signalling networks - Cat C2, D1
AS 1768	Signalling/Telecommunications surge protection
UL 497B	Protectors for data, communications and fire-alarm circuits
ITU-T K.44	Resistibility tests for telecommunication equipment exposed to overvoltages and overcurrents
AS/CA S008	Requirements for Customer Cabling Products
AS/NZS 4117	Surge Protective Devices for Telecommunications Applications
AS/CA S009	Installation requirements for customer cabling (Wiring rules)

Mechanical Specifications

Minimum operating temperature		-40°C
Maximum operating temperature		85°C
Minimum operating humidity		5%
Maximum operating humidity		95%
Mounting method		TS35 DIN Rail
Environmental rating		IP20
Enclosure material		Aluminium
Enclosure finish		Black Powdercoat
Terminal type		RJ45 socket
Length		30mm
Width		30mm
Height		90mm

Other Specifications

Product Code		DRJ45-1CAT6
--------------	---	-------------

Shipping Specifications

Weight		150g
Customs tariff		85363000, 85363010