

# Safety Network Controller

## NX Series



Safety over  
EtherCAT®



# Quick, easy and flexible integration of production line safety

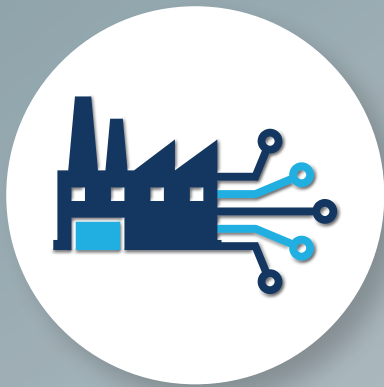

Scalable from large automotive production lines to small parts production lines

- Flexible safety system for large-scale production
  - Interlocking between various machines
- » Page 4



Quick and easy safety program design

- Reduce time required for design
  - Reduce time required for verification
- » Page 8



Efficient safety management and maintenance

- Minimize system downtime
  - Reduce maintenance work
- » Page 10

Manufacturers require flexible systems for global production and high-mix production. System designs have become more and more complicated because these flexible systems need safety control according to control programs. However, it is also required to reduce design and maintenance time to efficiently build various systems. In order to meet these needs, we offer a new NX Safety Network Controller.

### Safety control for large systems



Communication Control Unit  
NX-CSG320  
**NEW**

Safety CPU Unit  
NX-SL5500/5700  
**NEW**

### High-speed safety control for mid-size systems



Safety over  
**EtherCAT®**



Machine Automation Controller  
NX-102  
**NEW**

Safety CPU Unit  
NX-SL5500/5700  
**NEW**



Safety I/O Terminal  
I/O model GI-SMD1624 **NEW**



Safety I/O Terminal  
Input model GI-SID1224 **NEW**



Automation Software  
Sysmac Studio  
SYSMAC-SE/FE

### EtherNet/IP™

EtherNet/IP™ is a widely used and vendor-independent industrial Ethernet network that is managed by ODVA.



The Common Industrial Protocol (CIP™) is an industry standard open network, enabling seamless communication among CIP networks. CIP Safety™ adds safety functionality to CIP networks.

### EtherCAT®

EtherCAT® is an industrial real-time communication network promoted by EtherCAT Technology Group (ETG).

### Safety over EtherCAT®

Safety over EtherCAT (FSoE) allows a single communication system to be used for both control and safety data.

## Flexible safety system for large-scale production

### EtherNet/IP for safety across the world

Production systems have to meet worldwide standards because of the globalization of production. CIP Safety is a protocol for transmitting safety data via EtherNet/IP that is adopted by factory automation and robot manufacturers all over the world. Using CIP Safety, you can build globally standardized networks and simplify the global procurement of production systems.

### One connection using CIP Safety

Safety systems for industrial robots are becoming increasingly used; networks can be easily built with the NX-CSG Communication Control Unit and NX-SL5 Safety CPU Units which support CIP Safety.



### EtherNet/IP brings flexibility

Multiple network ports enable a safety network to be divided into several segments, making it easy to connect many network devices required for a large production line. This allows flexibility to add or remove devices from existing safety systems.

Safety control between lines :Port 1  
Robot control within process :Port 2A, 2B

EtherNet/IP port 1

EtherNet/IP port 2A

EtherNet/IP port 2B

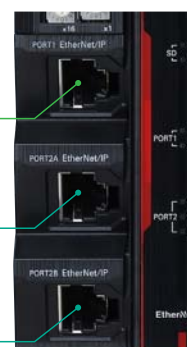

### Fast and fixed response cycle facilitates reconfiguration

The NX-CSG320 Communication Control Unit and NX-SL5 Safety CPU Unit provide safety communications via CIP safety and at the same time provides local high-speed safety I/O control. With a local I/O response time as low as every 50 ms, the NX-SL5 Safety CPU Unit can be used for applications where a high level of responsiveness is required.

\* Calculate the response speed of your system taking the performance of I/O devices into consideration. Refer to the manual for details.

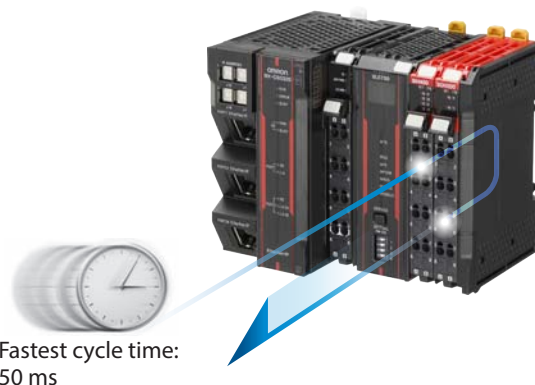

## Standardize the safety system network for a large robot system

### System configuration

In this example, devices and machines communicate via EtherNet/IP and CIP Safety in this system. Each process includes robots, safety light curtains, emergency stop switches, and other safety components. The NX-CSG Communication Control Unit and NX-SL5 Safety CPU Unit execute safety control programs in each process. CIP Safety is used for safety interlocking between processes and for building a safety control network across the system.

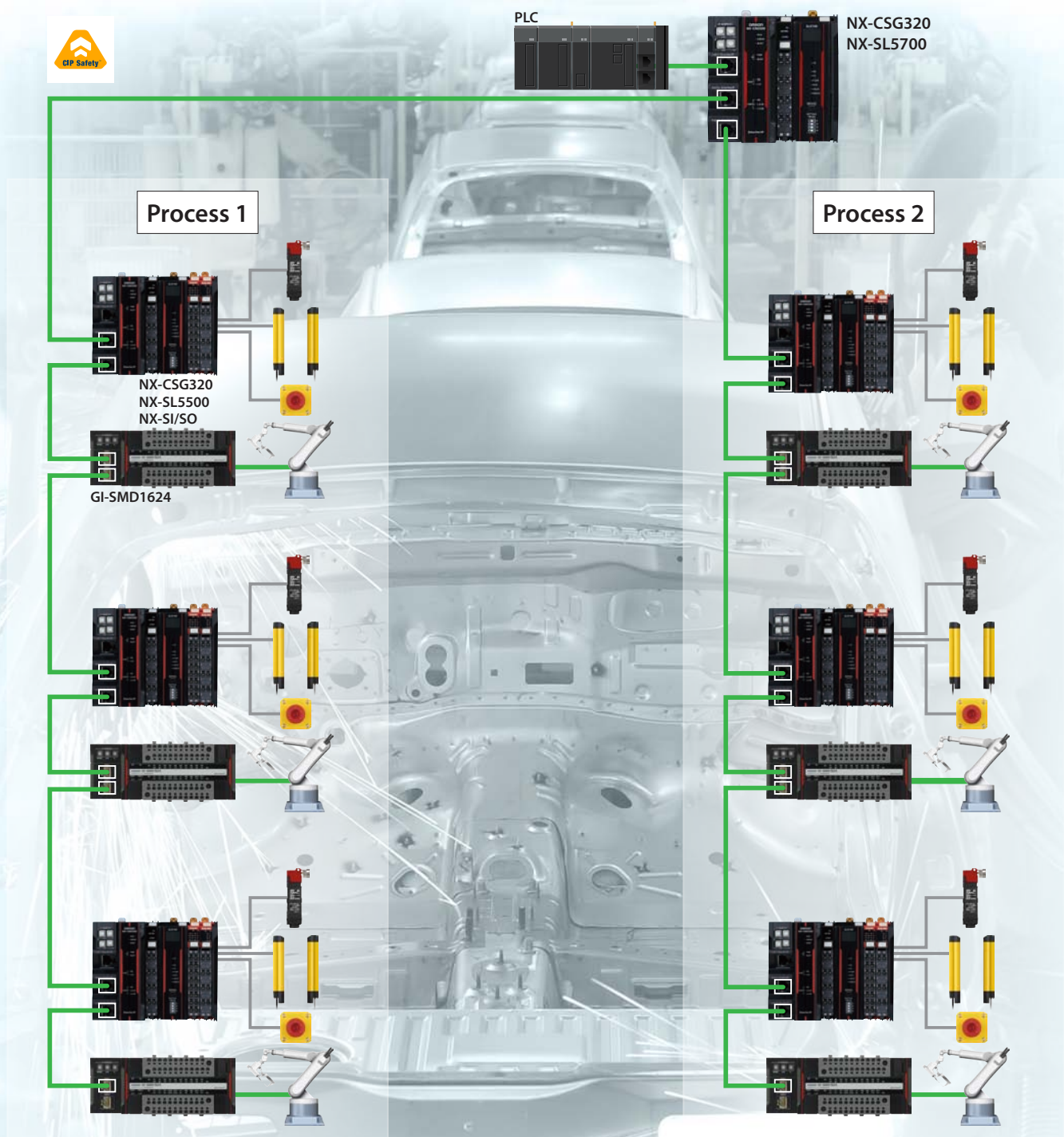

— EtherNet/IP & CIP Safety    
    
— Hardware cabling

\* Understand the connection specifications of devices which are used in the system before creating a network.

## Interlocking between various machines

### Simple configuration

CIP Safety allows safety devices and standard devices to be mixed on the same network, providing safety interlock control between machines. CIP Safety robots and remote I/O terminals can be easily connected.

### Modular processes bring flexibility to line layouts

The NX-CSG320 Communication Control Unit and NX-SL5 Safety CPU Unit exchange interlock signals with other machines while implementing safety control within the machine. Programs for machine control and safety control can be created for each machine. This modularized design helps standardize design and improve design efficiency.

### Modular machines with individual CPU units

#### System configuration

Machine 1 and 3 are processing machines with the control program and safety control program for each machine. Machine 2 is a material handling machine that transports products processed by Machine 1 and 3 to the next process. The NX-CSG320 Communication Control Unit and NX-SL5 Safety CPU Unit are used for all machines, and CIP Safety is used for safety interlocking between machines.

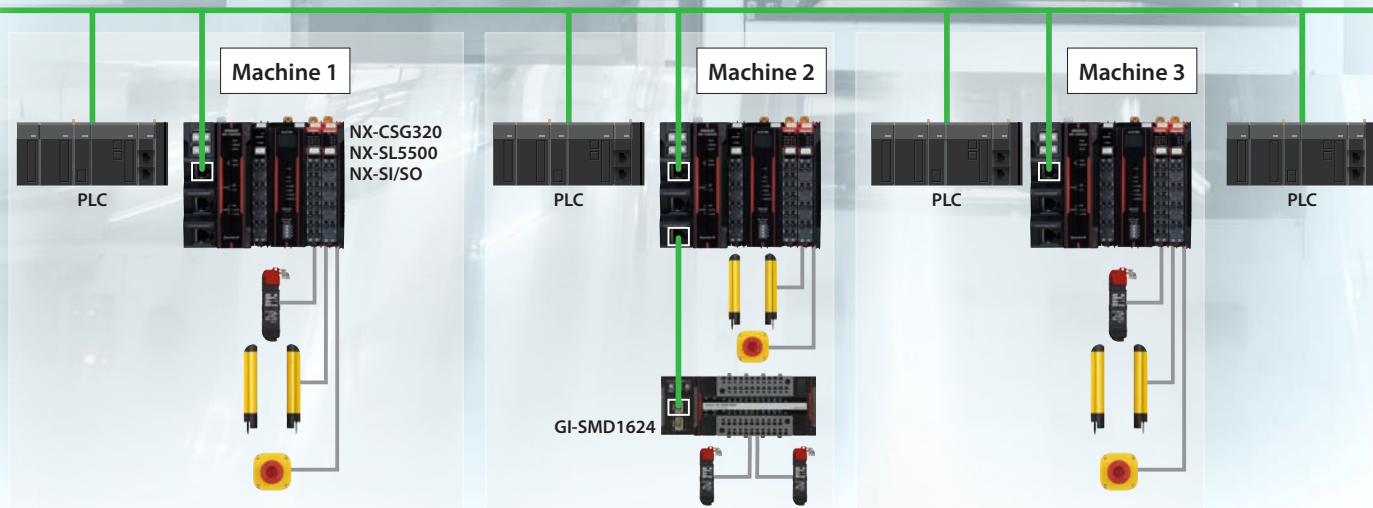

## Two different networks in a single system

The NX-SL5 Safety CPU Unit connected with the NX102 Machine Automation Controller enables the use of both EtherCAT + FSoE (Safety over EtherCAT) and EtherNet/IP + CIP Safety at the same time.

In addition to interlock control within a machine via FSoE, safety interlock between machines can be implemented using CIP Safety.

### Integrated safety into high-speed machine control

The NX-SL5 Safety CPU Unit combination with the NX102 Machine Automation Controller, provides both safety control and machine control with fast cycle times.

By mounting the NX-SL Safety CPU Unit and safety I/O units to the NX102 and by connecting the servo drives via FSoE on EtherCAT, you can configure a simple motion and safety control system using high-speed networks.

### Line safety control and fast machine control at the same time

#### System configuration

The NX102 Machine Automation Controller and NX-SL5 Safety CPU Unit are used in Machine 1 and 2 to build a system with safety network and real-time control capabilities using EtherCAT. The machine status is reported to the host system and displayed on the HMI connected on the same network.

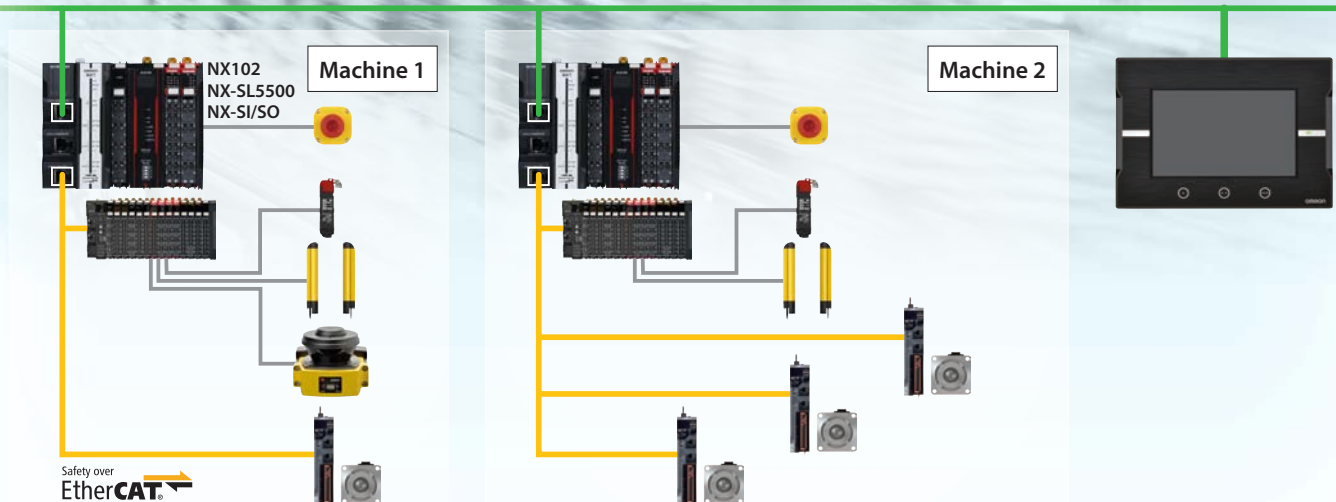

\* Understand the connection specifications of devices which are used in the system before creating a network.

## Improve design productivity

The Automation Software Sysmac Studio provides various functionalities to reduce time required for production system design and safety program verification.

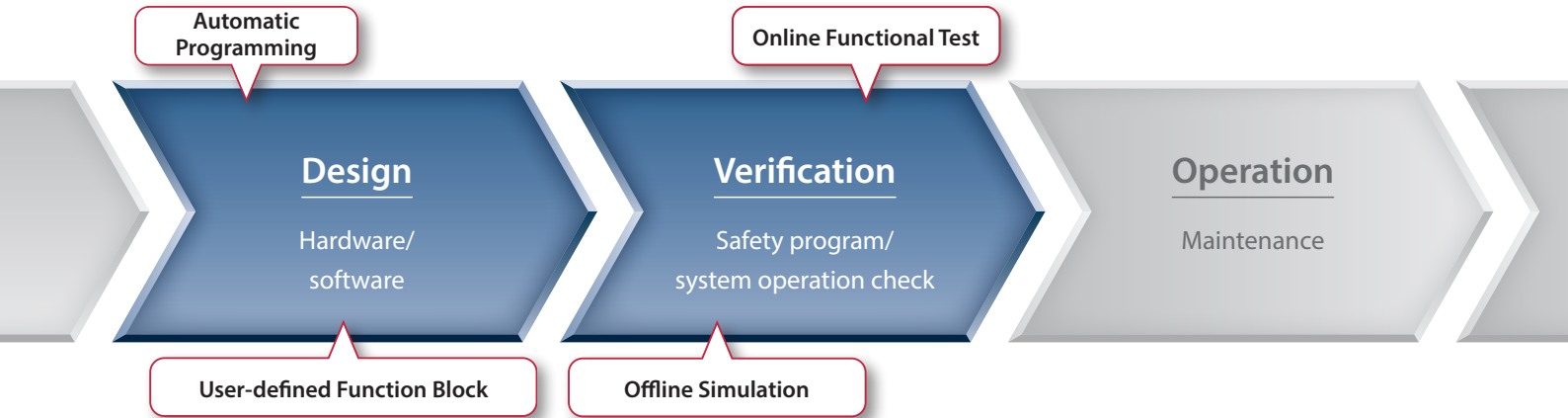

### Design Reduce time required for production system design

#### Automatic Programming

Create a truth table using input, output, and stop conditions of safety devices to automatically create a safety program for a simple machine.

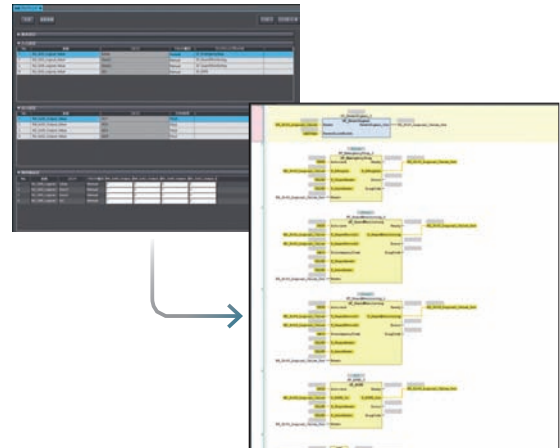

\* Programs created by Automatic Programming will not guarantee functional safety. Refer to the User's Manual (Cat. No. Z395) for details.

#### User-defined Function Block (FB)

Programs can be easily converted into a user-defined function block (FB); help files can be attached to describe input and output conditions as well as the functionality of the program within the function block (FB). Different security levels can be set to protect the function block from viewing and unauthorized modifications.

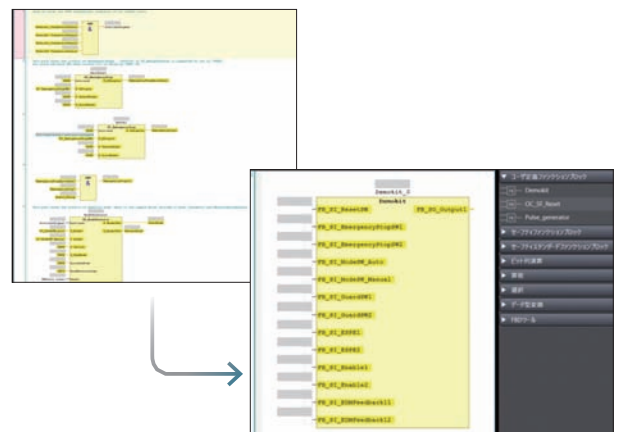

\* User-defined FBs can be used as modular software components according to the hardware configuration. They help standardize programs and maintain the consistency of design quality.



**Verification**

# Implement safety management without experts and global standardization

## Offline Simulation

Programs can be simulated on your PC, Sysmac Studio allows verification of programs without connecting hardware.



## Online Functional Test

Online Functional Test enables operation of safety functions to be checked when the NX-SL5 Safety CPU Unit is online with Sysmac Studio. The test results can be output as a report along with the safety signature; the safety signature is displayed on the seven-segment display of the NX-SL5 Safety CPU Unit, and can easily checked if the configuration matches the report after the program has been validated.



Safety Signature:#BF32

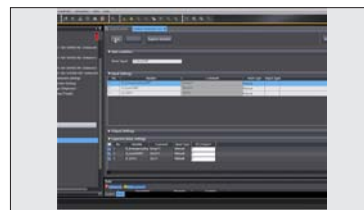

[Preparation]  
Start the Sysmac Studio and go online with the NX-SL5. Register the safety devices to test and set the expected values of each signal.



[Testing]  
Operate safety devices by following the instructions on the screen. Check if each device operates correctly and input the check results.



[Tests completed]  
The test results are listed after all tests have been completed. The list can be output as a CSV file.



[Printing test results]  
The test details, results, and executed date and time can be output as a PDF file. The names of the tester and approver can be added. The safety signature code, which identifies the validated program, is included at the bottom right of the report.

# Maintenance without PC

No PC is required for maintenance, which reduces production system maintenance work and minimizes system downtime.

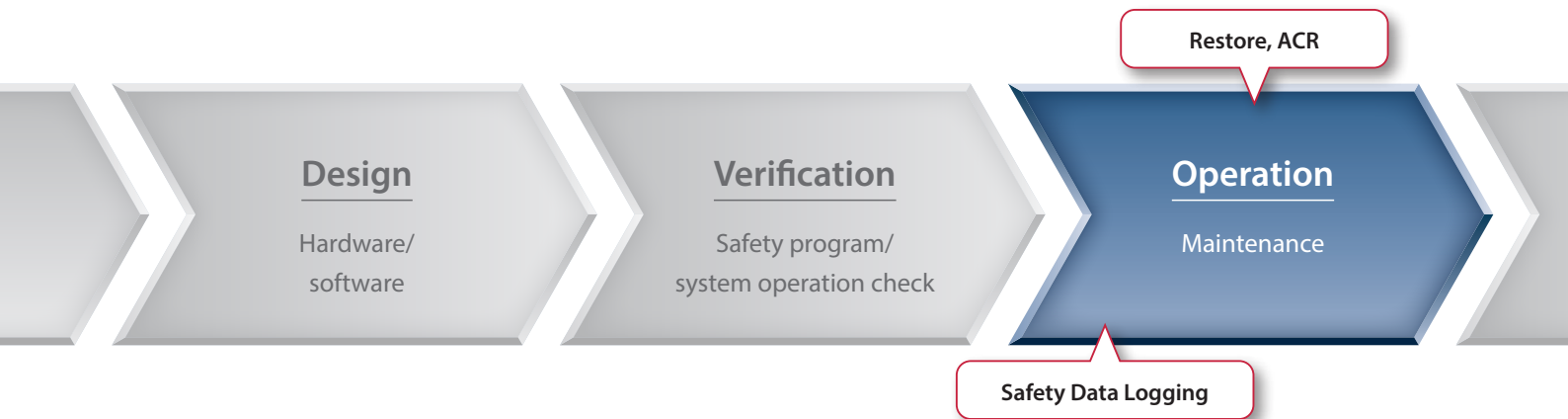

## Operation Minimize system downtime

### Safety Data Logging

An SD memory card containing logging settings is used for Safety Data Logging.

When start trigger conditions are met, the specified device variables and exposed variables can be logged in a chronological order and output to the SD memory card. This function helps to quickly identify the cause of a sudden stoppage of the system and determine preventive measures.

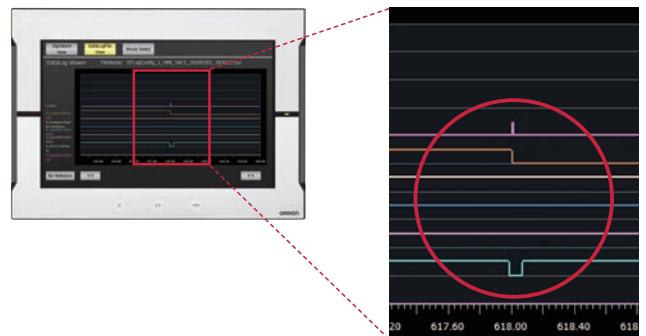

## Operation Reduce maintenance work

### Safety Unit Restore

Programs and settings can be stored on an SD memory card inserted into the communication control unit. When the safety CPU unit is replaced, the stored programs and settings can be easily copied to a new unit using the SD memory card.







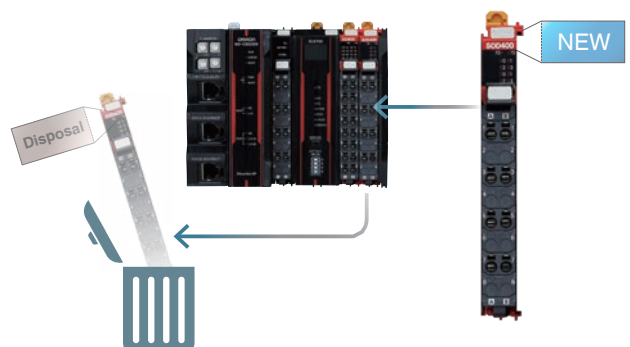





### ACR (Automatic Configuration Restart)

When replacing a safety I/O unit, just remove the old unit and mount a new one. The setting data is automatically downloaded. When replacing a safety I/O terminal, remove the memory cassette from the old terminal and install it into the new terminal to inherit the settings. No software is required. (See page 34)





**Existing products**

Choose a safety controller to suit your application.

Product name	Features	Catalog
<p>NX Safety Controller Safety Control Unit NX-SL3/SI/SO</p> 	<p><b>Integration of safety into machine automation enables simple, flexible system configuration</b></p> <ul style="list-style-type: none"> <li>● Fully integrate safety and standard control in one network by connecting with an NX EtherCAT Coupler Unit</li> <li>● Safety CPU unit: Up to 128 safety I/O units</li> <li>● Safety input unit: 8 or 4 safety input points per unit 4-channel units can be directly connected with Omron non-contact switches and single-beam sensors</li> <li>● Safety output unit: 2 or 4 safety output points per unit Output breaking current of 2.0 A (2-channel units)</li> <li>● PLCopen® Function Blocks for Safety</li> <li>● Standard IEC 61131-3 programming</li> </ul>	 <p>(Cat. No.) F100</p>  <p>(Cat. No.) F101</p>
<p>Safety Network Controller NE1A-SCPU Series</p> 	<p><b>Acts as a DeviceNet Safety master and slave and hosts the safety application program</b></p> <ul style="list-style-type: none"> <li>● NE1A-SCPU01-V1 with built-in 16 safety inputs and 8 safety outputs</li> <li>● NE1A-SCPU02 with built-in 40 safety inputs and 8 safety outputs</li> <li>● Simplifies safety systems. With safety network master capabilities, up to 32 safety nodes</li> <li>● Safety system can be monitored by standard controller via DeviceNet</li> </ul>	 <p>Refer to your local OMRON website</p>
<p>Safety Network Controller NE1A-SCPU0□-EIP</p> 	<p><b>Acts as a DeviceNet Safety master and slave and monitors safety system via EtherNet/IP</b></p> <ul style="list-style-type: none"> <li>● Connect with Omron PLC via EtherNet/IP for easy maintenance</li> <li>● Simplifies safety systems. With safety network master capabilities, up to 32 safety nodes</li> <li>● No external devices required for connecting to EtherNet/IP</li> </ul>	 <p>Refer to your local OMRON website</p>
<p>Safety Network Controller NE0A-SCPU01</p> 	<p><b>As a standalone controller as well as a DeviceNet Safety slave</b></p> <ul style="list-style-type: none"> <li>● TÜV-certified templates for safety applications with up to 12 inputs</li> <li>● Reusable user-defined safety circuit templates for easy standardization</li> <li>● NE0A operating status can be monitored by standard DeviceNet master</li> </ul>	 <p>Refer to your local OMRON website</p>
<p>Safety Controller G9SP Series</p> 	<p><b>Standalone safety controller</b></p> <ul style="list-style-type: none"> <li>● Easy programming for complex safety control</li> <li>● Unique programming software (G9SP Configurator) to support easy design and verification</li> </ul>	 <p>(Cat. No.) F090</p>

**Related product**

Product name	Features	Catalog
<p>Machine Automation Controller NX1</p> 	<p>NX102 CPU Unit NX102-□□□□</p> <p><b>Brings advanced control in miniaturized size</b></p>	 <p>(Cat. No.) P129</p>  <p>(Cat. No.) P130</p>

# NX-series Communication Control Unit/Safety Control Units

# NX-CSG/SL5/SI/SO

## Quick, easy, and flexible to integrate safety into production lines



For the most recent information on models that have been certified for safety standards, refer to your OMRON website.

- Two built-in CIP Safety on EtherNet/IP ports
- Up to 254 connections (NX-SL5700)
- Up to 32 NX Units per Communication Control Unit
- Innovative automation software
  - Automatic Programming
  - Safety Data Logging
  - Online Functional Test
- Meets EN ISO 13849-1 (PLe/Safety Category 4) and IEC 61508 (SIL3)

\* The Common Industrial Protocol (CIP™) is an industry standard open network, enabling seamless communication among CIP networks. CIP Safety™ adds safety functionality to CIP networks.

\* Safety over EtherCAT (FSoE): The open protocol Safety over EtherCAT (abbreviated with FSoE "Safety over EtherCAT") defines a safety related communication layer for EtherCAT. Safety over EtherCAT meets the requirements of IEC 61508 SIL 3 and enables the transfer of safe and standard information on the same communication system without limitations with regard to transfer speed and cycle time.

## Features

- CIP Safety on EtherNet/IP Is Supported
- Feature EtherNet/IP Communications Port
- The Standard Unit of NX-series Available
- Excellent Connectability with OMRON Safety I/O Devices
- Support for the IEC 61131-3 Programming Environment
  - Program Languages Based on the IEC 61131-3 International Standard
  - Programming with Variables
- Complete Advanced Validation
  - Checking Safety Programs and Safety Parameters
  - Debugging

### Trademarks

- Sysmac and SYSMAC are trademarks or registered trademarks of OMRON Corporation in Japan and other countries for OMRON factory automation products.
- Microsoft, Windows, Windows Vista, Excel, and Visual Basic are either registered trademarks or trademarks of Microsoft Corporation in the United States and other countries.
- EtherCAT® is registered trademark and patented technology, licensed by Beckhoff Automation GmbH, Germany.
- Safety over EtherCAT® is a registered trademark and a patented technology licensed by Beckhoff Automation GmbH, Germany.
- ODVA, CIP™, CompoNet™, DeviceNet™, EtherNet/IP™, and CIP Safety™ are trademarks of ODVA.
- The SD and SDHC logos are trademarks of SD-3C, LLC.

Other company names and product names in this document are the trademarks or registered trademarks of their respective companies.

### Copyrights

- Microsoft product screen shots reprinted with permission from Microsoft Corporation.
- This product incorporates certain third party software. The license and copyright information associated with this software is available at [http://www.fa.omron.co.jp/nj\\_info\\_e/](http://www.fa.omron.co.jp/nj_info_e/).

## CPU Rack Configuration

The following shows the CPU Rack Configuration, where NX Units are mounted to a CPU Rack. The CPU Rack is configured with a Communication Control Unit, a Safety CPU Unit, Safety I/O Units, other NX Units, and an End Cover mounted to it. The number of NX Unit connections is up to 32 units.

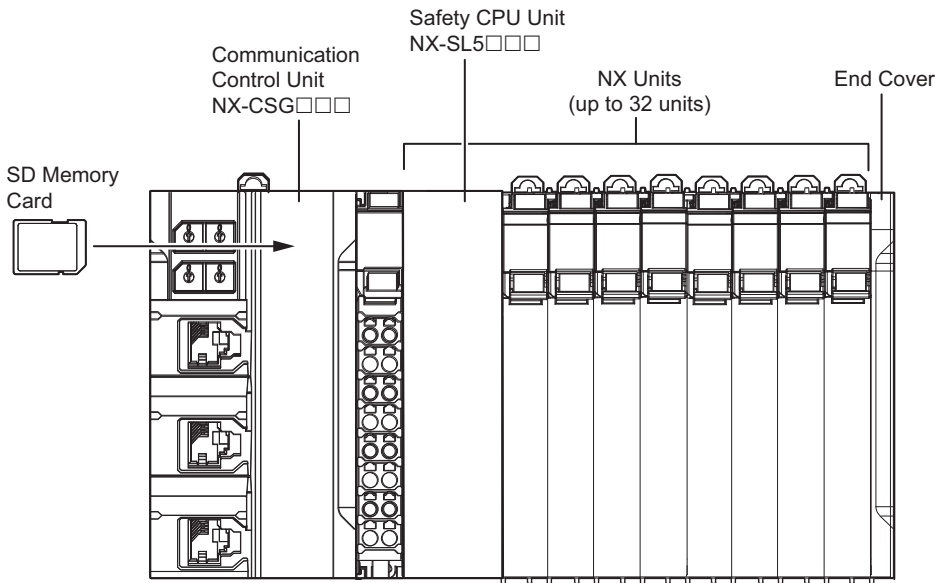

Configuration		Remarks
Communication Control Unit NX-CSG□□□		One required for every CPU Rack.
End Cover		Must be connected to the right side of the CPU Rack. One end cover is provided with the Communication Control Unit as a standard accessory.
NX Unit	Safety CPU Unit NX-SL5□□□	Up to 32 units can be mounted onto the CPU Rack. One Safety CPU Unit is required for each CPU Rack. Refer to <i>NX-series Safety Control Unit/Communication Control Unit User's Manual</i> (Cat. No. Z395) for the NX Units that you can connect.
	Safety Input Unit	
	Safety Output Unit	
	Other NX Units	
SD Memory Card		Install as required.

# NX-CSG/SL5/SI/SO

## Ordering Information

### NX-series Communication Control Unit

Unit type	Appearance	Supported communications protocol	Number of communications connectors	Network variables	Unit version	Model
Communication Control Unit		EtherNet/IP *1	3	2 *2	Ver. 1.01	<b>NX-CSG320</b>



**Note:** One NX-END02 End Cover is provided with the NX-CSG320 Communication Control Unit.

\*1. Routing of the CIP Safety protocol is supported.

\*2. PORT1 is an independent port. PORT2A and PORT2B are the ports with a built-in Ethernet switch.



### NX-series Safety Control Units

#### Safety CPU Units

Unit type	Appearance	Specifications				Unit version	Model
		Maximum number of safety I/O points	Program capacity	Number of safety I/O connections	I/O refreshing method		
Safety CPU Unit (NX-SL5□□□)		1024 points	2048 KB	128	Free-Run refreshing	Ver. 1.4	<b>NX-SL5500</b>
		2032 points	4096 KB	254	Free-Run refreshing	Ver. 1.4	<b>NX-SL5700</b>

**Note:** Refer to your local OMRON website for details of the NX-SL3□□□ Safety CPU Unit.

#### Safety Input Units

Unit type	Appearance	Specifications							Unit version	Model
		Number of safety input points	Number of test output points	Internal I/O common	Rated input voltage	OMRON special safety input devices	Number of safety slave connections	I/O refreshing method		
Safety Input Units		4 points	2 points	Sinking inputs (PNP)	24 VDC	Cannot be connected. *	1	Free-Run refreshing	Ver. 1.1	<b>NX-SIH400</b>
		8 points	2 points	Sinking inputs (PNP)	24 VDC	Cannot be connected.	1	Free-Run refreshing	Ver. 1.0	<b>NX-SID800</b>



\* The following OMRON special safety input devices can be connected directly without a special controller.

For detail of connectable OMRON special safety input devices, refer to *NX-series User's Manual Safety Control Unit/Communication Control Unit* (Cat. No. Z395).

Type	Model and corresponding PL and safety category
OMRON Single-beam Safety Sensors	E3ZS
OMRON Non-contact Door Switches	D40Z D40A
OMRON Safety Mats	UM, UMA *
OMRON Safety Edges	SGE (4-wire connection)

\* The UM Series was discontinued at the end of June 2019.

#### Safety Output Units

Unit type	Appearance	Specifications						Unit version	Model
		Number of safety output points	Internal I/O common	Maximum load current	Rated voltage	Number of safety slave connections	I/O refreshing method		
Safety Output Units		2 points	Sourcing outputs (PNP)	2.0 A/point, 4.0 A/Unit at 40°C, and 2.5 A/Unit at 55°C The maximum load current depends on the installation orientation and ambient temperature.	24 VDC	1	Free-Run refreshing	Ver. 1.0	<b>NX-SOH200</b>
		4 points	Sourcing outputs (PNP)	0.5 A/point and 2.0 A/Unit	24 VDC	1	Free-Run refreshing	Ver. 1.0	<b>NX-SOD400</b>

## Automation Software Sysmac Studio

Please purchase a DVD and required number of licenses the first time you purchase the Sysmac Studio. DVDs and licenses are available individually. Each model of licenses does not include any DVD.

Product name	Specifications	Number of licenses	Media	Model
		1 license	---	
<b>Sysmac Studio Safety Edition *1</b> Ver. 1.□□	Sysmac Studio Safety Edition is a license including necessary setting functions for the safety control system. *This product is a license only. You need the Sysmac Studio Standard Edition DVD media to install it.			<b>SYSMAC-FE001L</b>
<b>Sysmac Studio Standard Edition *2</b> Ver. 1.□□	Sysmac Studio runs on the following OS. Windows 7(32-bit/64-bit version)/8(32-bit/64-bit version)/8.1(32-bit/64-bit version)/10(32-bit/64-bit version) *3	--- (Media only)	Sysmac Studio (32bit) DVD	<b>SYSMAC-SE200D</b>
		--- (Media only)	Sysmac Studio (64bit) DVD	<b>SYSMAC-SE200D-64</b>

**Note:** For details of the Automation Software Sysmac Studio, refer to your local OMRON website.

\*1. The Safety Edition can be used with the Communication Control Unit and EtherNet/IP Coupler Unit.

\*2. The Sysmac Studio Standard Edition License (SYSMAC-SE2□□L) includes functions that the Safety Edition (SYSMAC-FE001L) provides.  
The Communication Control Unit can be used with the Sysmac Studio version 1.24 or higher.

\*3. Model "SYSMAC-SE200D-64" runs on Windows 10 (64bit).

## Optional Products

Product name	Specification	Model
Memory Card	SD memory card, 2 GB	<b>HMC-SD291</b>
	SD memory card, 4 GB	<b>HMC-SD491</b>

Product Name	Specification	Model
Unit/Terminal Block Coding Pins	For 10 Units (Terminal Block: 30 pins, Unit: 30 pins)	<b>NX-AUX02</b>

Product name	Specification				Model
	No. of terminals	Terminal number indications	Ground terminal mark	Terminal current capacity	
Terminal Block	8	A/B	Provided	10 A	<b>NX-TBC082</b>
	8	A/B	None	10 A	<b>NX-TBA082</b>
	16	A/B	None	10 A	<b>NX-TBA162</b>

## Accessories

### Communication Control Unit Accessories

**End Cover (NX-END02): 1**

One End Cover is provided with the Communication Control Unit.

# NX-CSG/SL5/SI/SO

## Specifications

### Regulations and Standards

#### NX-series Safety Control Units

#### Safety CPU Units NX-SL5500/SL5700

Certification body	Standards
TÜV Rheinland *1	<ul style="list-style-type: none"> <li>• EN ISO 13849-1</li> <li>• EN ISO 13849-2</li> <li>• IEC 61508 parts 1-7</li> <li>• IEC/EN 62061</li> <li>• IEC/EN 61131-2</li> </ul> <ul style="list-style-type: none"> <li>• IEC 61326-3-1</li> <li>• IEC 61131-6 *2</li> </ul>
UL	<ul style="list-style-type: none"> <li>• NRAG (UL 61010-1, UL 61010-2-201 and UL 121201)</li> <li>• NRAG7 (CSA C22.2 No. 61010-1, CSA C22.2 No. 61010-2-201 and CSA C22.2 No. 213)</li> <li>• FSPC (IEC 61508 and ISO 13849) *2</li> </ul>

#### Safety Input/Output Units NX-SI/SO

Certification body	Standards
TÜV Rheinland *1	<ul style="list-style-type: none"> <li>• EN ISO 13849-1</li> <li>• EN ISO 13849-2</li> <li>• IEC 61508 parts 1-7</li> <li>• IEC/EN 62061</li> <li>• IEC/EN 61131-2</li> </ul> <ul style="list-style-type: none"> <li>• IEC 61326-3-1</li> </ul>
UL	<ul style="list-style-type: none"> <li>• NRAG (UL 508 and ANSI/ISA 12.12.01)</li> <li>• NRAG7 (CSA C22.2 No. 142 and CSA C22.2 No. 213)</li> </ul>

\*1. The FSoE protocol was certified for applications in which OMRON FSoE devices are connected to each other.

For compatibility with FSoE devices other than OMRON FSoE devices, the customer must validate FSoE communications.

\*2. Only NX-SL5500/5700 have obtained IEC 61131-6 and FSPC certifications.

The NX-series Safety Control Units allow you to build a safety control system that meets the following standards.

- Requirements for SIL 3 (Safety Integrity Level 3) in IEC 61508, IEC/EN 62061, (Functional Safety of Electrical/Electronic/Programmable Electronic Safety-related Systems)
- Requirements for PL e (Performance Level e) and for safety category 4 in EN ISO13849-1

#### NX-series Communication Control Unit NX-CSG320

Certification body	Standards
UL	<ul style="list-style-type: none"> <li>• NRAG (UL 61010-1, UL 61010-2-201 and UL 121201)</li> <li>• NRAG7 (CSA C22.2 No. 61010-1, CSA C22.2 No. 61010-2-201 and CSA C22.2 No.213)</li> </ul>

#### NX-series Communication Control Unit NX-CSG320 and Safety Control Units NX-SL/SI/SO

Certification body	Standards
Shipbuilding Standards	NK, LK

The NX-series Communication Control Units and the NX-series Safety Control Units are also registered for RCM, EAC, and KC compliance.

## General Specifications

Item	Specification	
Enclosure	Mounted in a panel (open)	
Grounding method	Ground to 100 Ω or less	
Operating environment	Ambient operating temperature	0 to 55°C
	Ambient operating humidity	10% to 95% (with no condensation or icing)
	Atmosphere	Must be free from corrosive gases.
	Ambient storage temperature	-25 to 70°C (with no condensation or icing)
	Altitude	2,000 m max.
	Pollution degree	2 or less
	Noise immunity	Conforms to IEC 61131-2. 2 kV on power supply line
	Insulation class	Class III (SELV)
	Overvoltage category	II
	EMC immunity level	Zone B
	Vibration resistance	Conforms to IEC 60068-2-6. 5 to 8.4 Hz with 3.5-mm amplitude 8.4 to 150 Hz, acceleration of 9.8 m/s <sup>2</sup> 100 minutes each in X, Y, and Z directions (10 sweeps of 10 min each = 100 min total)
	Shock resistance	Conforms to IEC 60068-2-27. 147 m/s <sup>2</sup> , 3 times each in X, Y, and Z directions
Insulation resistance *	20 MΩ between isolated circuits (at 100 VDC)	
Dielectric strength *	510 VAC for 1 min between isolated circuits, leakage current: 5 mA max.	
Installation method	DIN Track (IEC 60715 TH35-7.5/TH35-15)	

\* The specification is for the Communication Control Unit, Safety Input Unit, and Safety Output Unit, not for the Safety CPU Unit.



# Specifications of Individual Units

## Communication Control Unit

<b>Unit name</b>	Communication Control Unit	
<b>Model</b>	NX-CSG320	
<b>Indicators</b>	<p>[RUN] indicator, [ERROR] indicator, [BUSY] indicator, [SD PWR] indicator, [SD BUSY] indicator, [NS] indicator × 2, [L/A] indicator, [L/A 2A] indicator, [L/A 2B] indicator, [TS] indicator, [UNIT PWR] indicator, [I/O PWR] indicator</p>	
<b>Hardware switch settings</b>	<p>[IP ADDRESS 1] Switch (x16, x1), [IP ADDRESS 2] Switch (x16, x1), DIP Switch</p> <p>* Factory default          • IP ADDRESS1: 192.168.1.1 [IP ADDRESS 1] Switch = "00"          • IP ADDRESS2: 192.168.250.1 [IP ADDRESS 2] Switch = "00"</p>	
<b>Dimensions *1</b>	72 × 100 × 90 mm (W × H × D)	
<b>Weight *2</b>	390 g	
<b>Number of NX Units that you can connect</b>	32 units or less	
<b>Number of communications that can be set between NX Units</b>	254 ports max. *3	
<b>Unit power supply</b>	<b>Power supply voltage</b>	24 VDC (20.4 to 28.8 VDC)
	<b>Unit power consumption *4</b>	5.95 W
	<b>Inrush current *5</b>	For cold start at room temperature: 10 A max./0.1 ms max. and 2.5 A max./150 ms max.
	<b>Current capacity of power supply terminal *6</b>	4 A
<b>Power supply to the NX Unit power supply</b>	<b>Isolation method</b>	No isolation: Between the Unit power supply terminal and internal circuit
	<b>NX Unit power supply capacity</b>	10 W max.
	<b>NX Unit power supply efficiency</b>	80%
<b>I/O power supply to NX Units</b>	<b>Isolation method</b>	No isolation: Between the Unit power supply terminal and NX Unit power supply
	<b>Power supply voltage</b>	5 to 24 VDC (4.5 to 28.8 VDC)
	<b>Maximum I/O power supply current</b>	4 A
<b>Current consumption from I/O power supply</b>	10 mA max. (24 VDC)	
<b>External connection terminals</b>	Screwless clamping terminal block (8 terminals)	
<b>Terminal connection diagram</b>	<p>UV/UG: Unit power supply terminals              IOV/IOG: I/O power supply terminals</p>	
<b>Accessories</b>	End cover (NX-END02): 1 pc.	
<b>Installation orientation and restrictions</b>	Only upright installation orientation	

\*1. Includes the End Cover, and does not include projecting parts.

\*2. Includes the End Cover. The weight of the End Cover is 82 g.

\*3. Includes the SD Memory Card. The NX Unit power consumption to NX Units is not included.

\*4. This is the inrush current value when the power supply turns ON after it has been OFF.

The inrush current may vary depending on the operating condition and other conditions. Therefore, select fuses, breakers, and external power supply devices that have enough margin in characteristic and capacity, considering the condition under which the devices are used.

Especially when you turn the power ON/OFF through a switch inserted to the external DC power supply, cycling power ON-OFF-ON within one second will cause the inrush current of approx. 30 A/0.3 mA to occur since the inrush current limiter circuit fails to limit the current.

\*5. The amount of current that can be passed constantly through the terminal. Do not exceed this current value when you use a through-wiring for the unit power supply.

\*6. The actual configurable number can be calculated as follows: 254 - <Number of CIP Safety connections configured> - <Number of FSOE connections configured>

## Built-in EtherNet/IP Port Specifications

The following table shows the specifications of the built-in EtherNet/IP port of the Communication Control Unit.

Item	Specification	
	NX-CSG-□□□	
Communications protocol	TCP/IP or UDP/IP	
Supported services	Sysmac Studio connection, tag data links, CIP message communications, FTP server, automatic clock adjustment (NTP client), SNMP (agent), DNS (client), BOOTP (client), TCP/UDP message service	
Number of logical ports	2 (With IP routing function)	
Physical layer	100Base-TX or 10Base-T (100Base-TX is recommended.) *1	
Transmission specifications	Media access method	CSMA/CD
	Modulation	Baseband
	Transmission paths	Star form
	Baud rate	100 Mbps (100BASE-TX)
	Transmission media	Shielded twisted-pair (STP) cable, Category 5, 5e or higher
	Transmission distance	100 m max. (distance between hub and node)
	Number of cascade connections	The built-in switching ports support up to 50 nodes. There is no limitation when an external Ethernet switch is used.
CIP Safety routing	Maximum number of routable CIP Safety connections	254 total For multi-cast connections, 128 total
	Maximum routable Safety data length per connection	32 bytes
CIP service: Tag data links (cyclic communications)	Number of connections	32/Logical ports (total of 64 with two logical ports)
	Packet interval (refresh cycle)	1 to 10,000 ms in 1-ms increments Packet intervals can be set independently for each connection. (Data is refreshed over the network at preset intervals and does not depend on the number of nodes.)
	Allowed communications bandwidth per Unit	12,000 pps *2 Note: The heartbeat and CIP Safety routing are included.
	Number of registrable tags	1024/Logical ports (total of 2048 with two logical ports)
	Tag types	Network variables
	Number of tags per connection (=1 tag set)	32 (31 tags if Controller status is included in the tag set.)
	Maximum link data size per node	46,208 bytes/Logical ports 92,416 bytes total
	Maximum data size per connection	1,444 bytes *3
	Number of registrable tag sets	Data concurrency is maintained within each connection. 32 per port (1 connection = 1 tag set) (total of 40 with two logical ports) *4
	Maximum size of 1 tag set	1,444 bytes (Two bytes are used if Controller status is included in the tag set.)
	Multi-cast packet filter *5	Supported.
CIP message service: Explicit messages *6	Class 3 (number of connections)	Connections: 16/Logical ports (total of 32 with two logical ports) (server only)
	UCMM (unconnected)	Maximum number of clients that can communicate at one time: 16 per port (total of 32 with two logical ports) Maximum number of servers that can communicate at one time: 16 per port (total of 32 with two logical ports)
TCP/UDP message service	Maximum number of clients that can communicate at one time	16 per port (total of 32 with two logical ports)
	Maximum message size	Request: 492 bytes Response: 496 bytes
SNMP	Agent	SNMPv1, SNMPv2c
	MIB	MIB-II
EtherNet/IP conformance test	Conforms to CT14	
Ethernet interface	10BASE-T or 100BASE-TX Auto negotiation or fixed settings	

\*1. If tag data links are being used, use 100Base-TX.

\*2. Here, pps means "packets per second" and indicates the number of packets that can be processed in one second.

\*3. To use a data size of 505 bytes or higher, the system must support a large forward open (an optional CIP specification).

The CS, CJ, NJ, and NX-series Units support a large forward open, but before connecting to nodes of other companies, confirm that those devices also support it.

\*4. If more than 40 tag sets are registered in total, the *Tag Data Link, Too Many Tag Sets Registered (840E0000 hex)* event will occur.

\*5. Because the built-in EtherNet/IP port is equipped with an IGMP client (version 2), unnecessary multicast packets can be filtered out by an Ethernet switch that supports IGMP Snooping.

\*6. The built-in EtherNet/IP port uses the TCP/UDP port numbers shown in the following table. Do not set the same port number for more than one TCP/UDP service.

Service	Type	Port number	Remarks
Tag data links	UDP	2222	Fixed values
Used by system	UDP	2223, 2224	
	TCP	9610	
CIP messages	TCP	44818	
FTP client (Data transfer port)	TCP	20	
DNS client	TCP/UDP	53	
BOOTP client	UDP	68	
HTTP server	TCP	80	You can change the port number in the Unit Settings on the Sysmac Studio.
Used by system, other	TCP/UDP	9600	
FTP client (Control port)	TCP	21	
TCP/UDP message service	TCP/UDP	64000	
NTP client	UDP	123	
SNMP agent	UDP	161	
SNMP trap	UDP	162	

## Safety Control Units

### Safety CPU Units NX-SL5500/SL5700

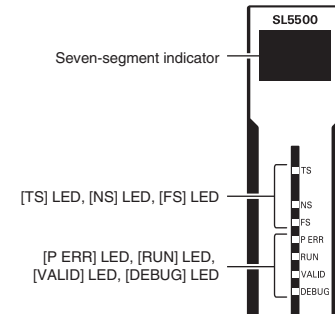
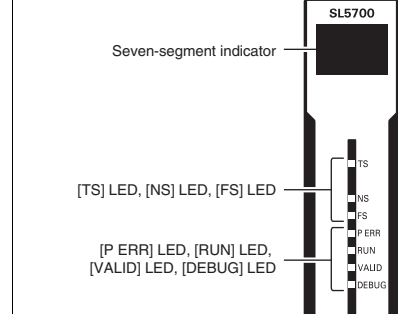
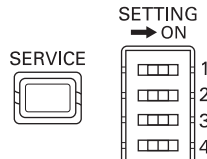
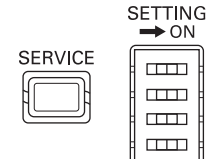
Unit name	Safety CPU Unit	
Model	NX-SL5500	NX-SL5700
Maximum number of safety I/O points	1024 points	2032 points
Program capacity	2048 KB	4096 KB
Number of safety master connections *1	128	254
Number of CIP Safety originator connections	128	254
Number of CIP Safety target connections	4	4
Number of originators that can be connected with a multi-cast connection	8	8
Number of FSoE master connections	128	254
I/O refreshing method	Free-Run refreshing	
External connection terminals	None	
Indicators	<p>[TS] indicator, [NS] indicator, [FS] indicator, [P ERR] indicator, [RUN] indicator, [VALID] indicator, [DEBUG] indicator, seven-segment indicator</p> 	<p>[TS] indicator, [NS] indicator, [FS] indicator, [P ERR] indicator, [RUN] indicator, [VALID] indicator, [DEBUG] indicator, seven-segment indicator</p> 
Hardware switch settings	<p>[SERVICE] switch, [SETTING] switch</p> 	<p>[SERVICE] switch, [SETTING] switch</p> 
Dimensions	30 x 100 x 71 mm (W x H x D)	
I/O power supply method	Not supplied.	
Current capacity of I/O power supply terminals	No I/O power supply terminals	
NX Unit power consumption	3.35 W max. *2	
Current consumption from I/O power supply	No consumption	
Weight	130 g max.	
Installation orientation and restrictions	Installation orientation: Upright installation Restriction *3: None.	

\*1. This is the maximum number of Safety I/O connections that can be set to this Unit. The value is the total number of CIP Safety originator connections, CIP Safety target connections, and FSoE master connections.  
 \*2. The cable length for the Units (Communication Control Unit and Power Supply Unit for NX Units) that supply power to the corresponding Unit must be up to 20 m.  
 \*3. Only NX102 CPU Units and Communication Control Units can be connected. NX1P2 CPU Units or Communications Coupler Units cannot be connected.

## Safety Input Units NX-SIH400/SID800

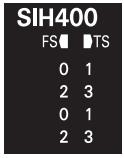
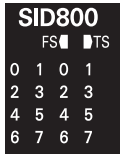
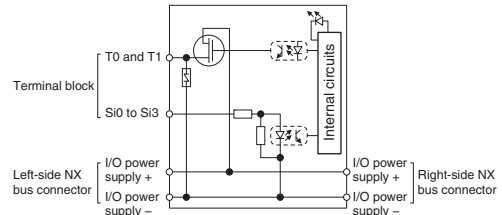
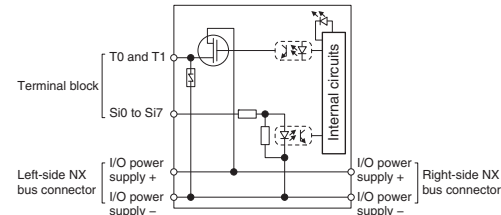
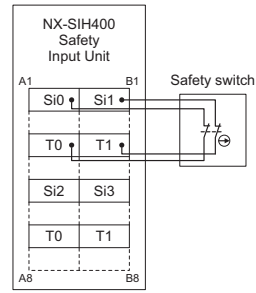
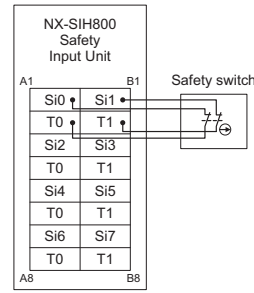
Unit name	Safety Input Unit	
Model	NX-SIH400	NX-SID800
Number of safety input points	4 points	8 points
Number of test output points	2 points	2 points
Internal I/O common	PNP (sinking inputs)	
Rated input voltage	24 VDC (20.4 to 28.8 VDC)	
OMRON special safety input devices	Can be connected.	Cannot be connected.
Number of safety slave connections	1	
I/O refreshing method	Free-Run refreshing	
External connection terminals	Screwless clamping terminal block (8 terminals)	Screwless clamping terminal block (16 terminals)
Indicators	[TS] indicator, [FS] indicator, [IN] indicator, [IN ERR] indicator 	[TS] indicator, [FS] indicator, [IN] indicator, [IN ERR] indicator 
Safety input current	4.5 mA TYP.	3.0 mA TYP.
Safety input ON voltage	11 VDC min.	15 VDC min.
Safety input OFF voltage/OFF current	5 VDC max., 1 mA max.	
Test output type	Sourcing outputs (PNP)	
Test output load current	25 mA max.	50 mA max.
Test output residual voltage	1.2 V max. (Between IOV and all output terminals)	
Test output leakage current	0.1 mA max.	
Dimensions	12 × 100 × 71 mm (W × H × D)	
Isolation method	Photocoupler isolation	
Insulation resistance	20 MΩ min. between isolated circuits (at 100 VDC)	
Dielectric strength	510 VAC for 1 min between isolated circuits, leakage current: 5 mA max.	
I/O power supply method	Power supplied from the NX bus	
Current capacity of I/O power supply terminals	No applicable terminals.	
NX Unit power consumption	<ul style="list-style-type: none"> <li>Connected to a CPU Unit or a Communication Control Unit 1.10 W max.</li> <li>Connected to a Communications Coupler Unit 0.70 W max.</li> </ul>	<ul style="list-style-type: none"> <li>Connected to a CPU Unit or a Communication Control Unit 1.10 W max.</li> <li>Connected to a Communications Coupler Unit 0.75 W max.</li> </ul>
Current consumption from I/O power supply	20 mA max.	
Weight	70 g max.	
Circuit layout		
Terminal connection diagram	<p>Si0 to Si3: Safety input terminals T0 and T1: Test output terminals</p>  <p>Refer to User's manual (Cat. No. Z395) for details.</p>	<p>Si0 to Si7: Safety input terminals T0 and T1: Test output terminals</p>  <p>Refer to User's manual (Cat. No. Z395) for details.</p>

Unit name	Safety Input Unit
<b>Installation orientation and restrictions</b>	Installation orientation: <ul style="list-style-type: none"> <li>• Connected to a CPU Unit or a Communication Control Unit * Possible in the upright installation orientation.</li> <li>• Connected to a Communications Coupler Unit 6 possible orientations.</li> </ul> Restrictions: Maximum ambient temperature is 50°C for any orientation other than upright installation.
<b>Protective functions</b>	Overvoltage protection circuit and short detection (test outputs)

\* Only NX102 CPU Units and Communication Control Units can be connected. NX1P2 CPU Units cannot be connected.

## Safety Output Units NX-SOH200/SOD400

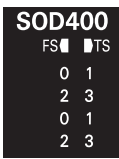
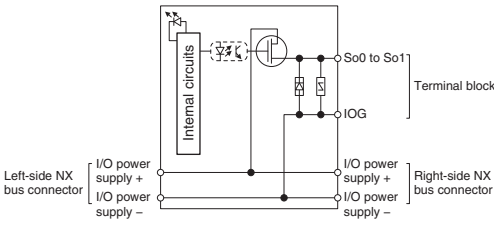
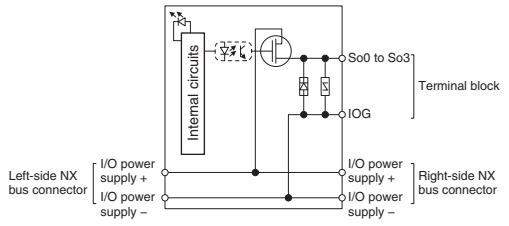
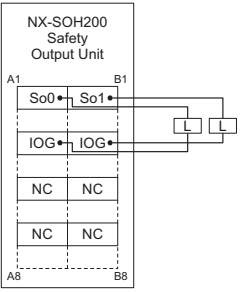
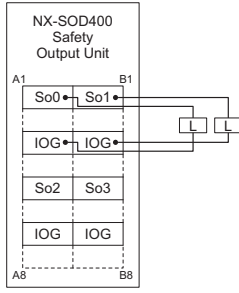
Unit name	Safety Output Unit	
Model	NX- SOH200	NX- SOD400
Number of safety output points	2 points	4 points
Internal I/O common	PNP (sourcing outputs)	
Maximum load current	2.0 A/point 4.0 A/Unit at 40°C 2.5 A/Unit at 55°C The maximum load current depends on the installation orientation and ambient temperature	0.5 A/point and 2.0 A/Unit
Rated voltage	24 VDC (20.4 to 28.8 VDC)	
Number of safety slave connections	1	
I/O refreshing method	Free-Run refreshing	
External connection terminals	Screwless clamping terminal block (8 terminals)	
Indicators	[TS] indicator, [FS] indicator, [OUT] indicator, [OUT ERR] indicator 	[TS] indicator, [FS] indicator, [OUT] indicator, [OUT ERR] indicator 
Safety output ON residual voltage	1.2 V max. (Between IOV and all output terminals)	
Safety output OFF residual voltage	2 V max. (Between IOG and all output terminals)	
Safety output leakage current	0.1 mA max.	
Dimensions	12 × 100 × 71 mm (W × H × D)	
Isolation method	Photocoupler isolation	
Insulation resistance	20 MΩ min. between isolated circuits (at 100 VDC)	
Dielectric strength	510 VAC for 1 min between isolated circuits, leakage current: 5 mA max.	
I/O power supply method	Power supplied from the NX bus	
Current capacity of I/O power supply terminals	IOG: 2 A max./terminal	IOG (A3 and B3): 2 A max./terminal IOG (A7 and B7): 0.5 A max./terminal
NX Unit power consumption	<ul style="list-style-type: none"> <li>Connected to a CPU Unit or a Communication Control Unit 1.05 W max.</li> <li>Connected to a Communications Coupler Unit 0.70 W max.</li> </ul>	<ul style="list-style-type: none"> <li>Connected to a CPU Unit or a Communication Control Unit 1.10 W max.</li> <li>Connected to a Communications Coupler Unit 0.75 W max.</li> </ul>
Current consumption from I/O power supply	40 mA max.	60 mA max.
Weight	65 g max.	
Circuit layout		
Terminal connection diagram	So0 and So1: Safety output terminals IOG: I/O power supply 0 V 	So0 to So3: Safety output terminals IOG: I/O power supply 0 V 
	Refer to User's manual (Cat. No. Z395) for details.	

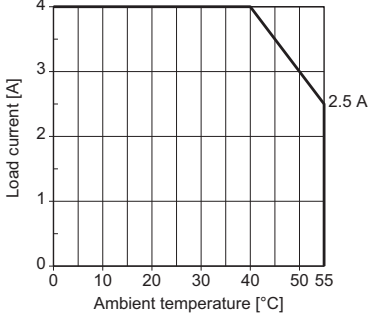
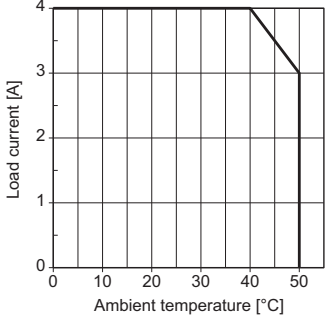
Unit name	Safety Output Unit	
<b>Model</b>	NX- SOH200	NX- SOD400
<b>Installation orientation and restrictions</b>	<p>Installation orientation:</p> <ul style="list-style-type: none"> <li>• Connected to a CPU Unit or a Communication Control Unit * Possible in the upright installation orientation.</li> <li>• Connected to a Communications Coupler Unit 6 possible orientations</li> </ul> <p>Restrictions: For upright installation, the ambient temperature is restricted as shown below depending on the total Unit load current.</p>  <p>For all installation orientations other than upright installation, the ambient temperature is restricted as shown below according to the total Unit load current.</p> 	
<b>Protective functions</b>	Overvoltage protection circuit and short detection (test outputs)	

\* Only NX102 CPU Units and Communication Control Units can be connected. NX1P2 CPU Units cannot be connected.

## Function Specifications

Refer to your local OMRON website for function specifications of the Communication Control Unit and Safety Control Unit.

# NX-CSG/SL5/SI/SO

## Version Information

### Relationship between the Unit Versions of Safety Control Units and Sysmac Studio Versions

This section describes the combinations that can be used of the unit versions of the Safety Control Unit and the Communication Control Unit, and the version of the Sysmac Studio.

#### Safety Control Units

NX Unit		Corresponding unit version/version	
Model	Unit version	Communication Control Unit	Sysmac Studio
NX-SL5500	Ver.1.3	Ver.1.01	Ver.1.24
	Ver.1.4		Ver.1.40
NX-SL5700	Ver.1.2	Ver.1.00 only	Ver.1.24
	Ver.1.3	Ver.1.01	
	Ver.1.4		Ver.1.40
NX-SIH400	Ver.1.0	Ver.1.00	Ver.1.24
NX-SIH400	Ver.1.1		
NX-SID800	Ver.1.0		
NX-SOH200			
NX-SOD400			



## Configuration Unit

Refer to the user's manuals for information on the NX Units that can be connected to the NX-series Communication Control Unit.

## Communication Control Unit

Unit	Model
Communication Control Unit	NX-CSG320

## Safety Control Units

Unit	Model
Safety CPU Unit	NX-SL5500, NX-SL5700
Safety Input Unit	NX-SIH400, NX-SID800
Safety Output Unit	NX-SOH200, NX-SOD400

## I/O Units

Unit	Model				
	2-point Units	4-point Units	8-point Units	16-point Units	32-point Units
Digital Input Unit	---	NX-ID3317 NX-ID3343 NX-ID3417 NX-ID3443 NX-IA3117	NX-ID4342 NX-ID4442	NX-ID5142-1 NX-ID5142-5 NX-ID5342 NX-ID5442	NX-ID6142-5 NX-ID6142-6
Digital Output Unit	NX-OC2633 NX-OC2733	NX-OD3121 NX-OD3153 NX-OD3256 NX-OD3257 NX-OD3268	NX-OD4121 NX-OD4256 NX-OC4633	NX-OD5121 NX-OD5121-1 NX-OD5121-5 NX-OD5256 NX-OD5256-1 NX-OD5256-5	NX-OD6121-5 NX-OD6121-6 NX-OD6256-5
Digital Mixed I/O Unit	---	---	---	NX-MD6121-5 NX-MD6121-6 NX-MD6256-5	---
Analog Input Unit	NX-AD2603 NX-AD2604 NX-AD2608 NX-AD2203 NX-AD2204 NX-AD2208	NX-AD3603 NX-AD3604 NX-AD3608 NX-AD3203 NX-AD3204 NX-AD3208	NX-AD4603 NX-AD4604 NX-AD4608 NX-AD4203 NX-AD4204 NX-AD4208	---	---
Analog Output Unit	NX-DA2603 NX-DA2605 NX-DA2203 NX-DA2205	NX-DA3603 NX-DA3605 NX-DA3203 NX-DA3205	---	---	---
Temperature Input Unit	NX-TS2101 NX-TS2102 NX-TS2104 NX-TS2201 NX-TS2202 NX-TS2204	NX-TS3101 NX-TS3102 NX-TS3104 NX-TS3201 NX-TS3202 NX-TS3204	---	---	---

## System Units

Unit	Model
Additional NX Unit Power Supply Unit	NX-PD1000
Additional I/O Power Supply Unit	NX-PF0630, NX-PF0730
I/O Power Supply Connection Unit	NX-PC0010, NX-PC0020, NX-PC0030
Shield Connection Unit	NX-TBX01

Communication Control Unit NX-CSG320

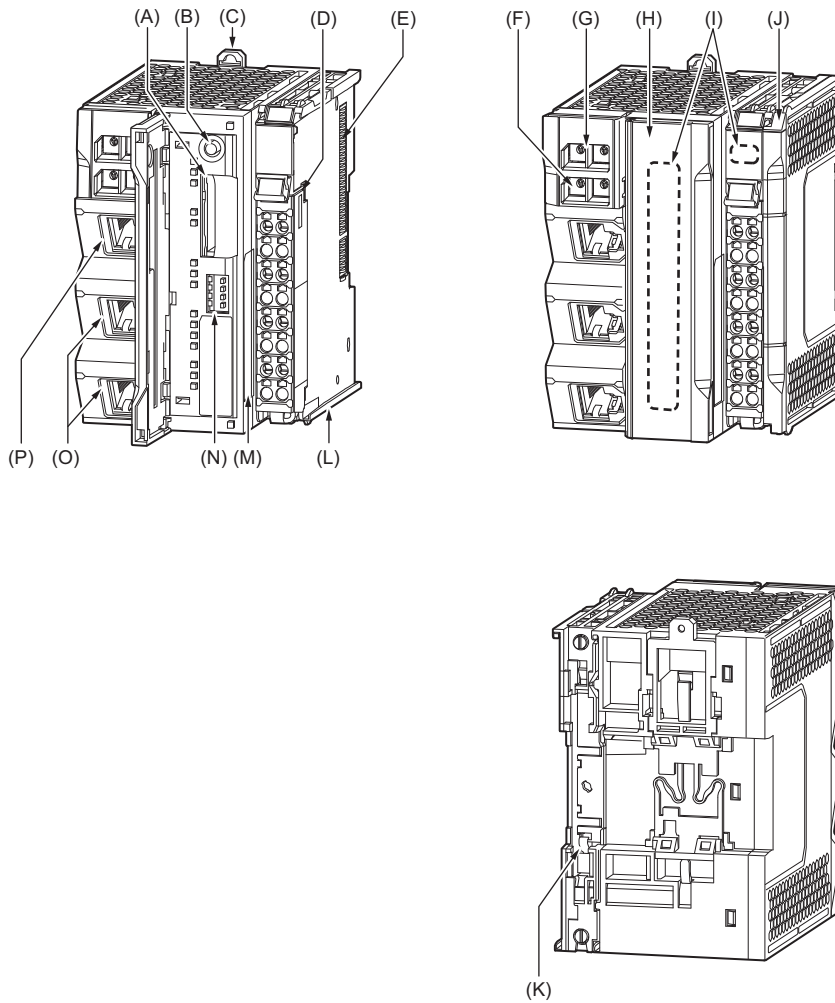

Letter	Name	Function
(A)	SD Memory Card connector	Connects the SD Memory Card to the Communication Control Unit.
(B)	SD Memory Card power supply switch	Turns OFF the power supply so that you can remove the SD Memory Card.
(C)	DIN Track mounting hooks	These hooks are used to mount the Unit to a DIN Track.
(D)	Terminal Block	Used for wiring the power supply and functional grounding wire.
(E)	NX bus connector	This connector is used to connect the Communication Control Unit to the NX Unit on the right of the Communication Control Unit.
(F)	IP Address Switch 2 (x16, x1)	Used for setting an IP address for the built-in EtherNet/IP port (PORT2A and PORT2B). Use the rotary switches and specify a two-digit hexadecimal number.
(G)	IP Address Switch 1 (x16, x1)	Used for setting an IP address for the built-in EtherNet/IP port (PORT1). Use the rotary switches and specify a two-digit hexadecimal number.
(H)	SD Memory Card cover	A cover for the SD Memory Card DIP switch area. It opens in the horizontal direction.
(I)	Operation Status Indicators	Show the operation status of Communication Control Unit by multiple indicators.
(J)	End Cover	A cover to protect the Communication Control Unit and NX Unit. One End Cover is provided with the Communication Control Unit as a standard accessory.
(K)	DIN Track contact plate	This plate is used to contact the functional ground terminal with a DIN Track.
(L)	Unit hookup guides	These guides are used to mount NX Units or End Cover.
(M)	ID Information Indication	Shows the ID information of the Unit.
(N)	DIP Switch	Used for backups. Normally, turn OFF all of the pins.
(O)	Built-in EtherNet/IP Port (PORT2)	Connects the built-in EtherNet/IP with an Ethernet cable. PORT2 consists of two RJ45 connectors (PORT2A and PORT2B) and has a built-in Ethernet switch.
(P)	Built-in EtherNet/IP Port (PORT1)	Connects the built-in EtherNet/IP with an Ethernet cable.

**Terminal Blocks**

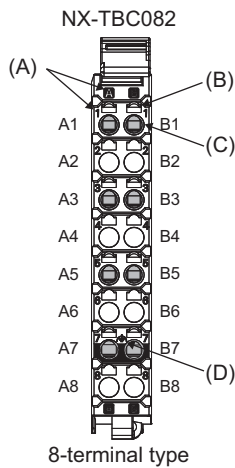

Letter	Name	Function
(A)	Terminal number indications	The terminal numbers are given by column letters A and B, and row numbers 1 to 8. The combination of the "column" and "row" gives the terminal numbers from A1 to A8 and B1 to B8. The terminal number indicators are the same regardless of the number of terminals on the terminal block, as shown above.
(B)	Release hole	Insert a flat-blade screwdriver into these holes to connect or remove the wires.
(C)	Terminal hole	The wires are inserted into these holes.
(D)	Ground terminal mark	This mark indicates the ground terminals.

Terminal Blocks come in three types depending on the number of terminals that can be used. There are 8-terminal, 12-terminal, and 16-terminal Terminal Blocks.

Only the 8-terminal type terminal block is compatible with Communication Control Unit.

To prevent incorrect insertion, terminal blocks in any other types besides the 8-terminal type cannot be mounted.

**Applicable Terminal Blocks for Each Model**

Current capacity of power supply terminals and applicable terminal blocks for each model of Communication Control Unit are shown in the following table.

Unit model number	Current capacity of power supply terminal for the Unit		Terminal block			
	Unit power supply	I/O power supply	Terminal block model	Number of terminals	Ground terminal mark	Terminal current capacity
NX-CSG320	4 A		NX-TBC082	8	Provided	10 A

**Indicators**

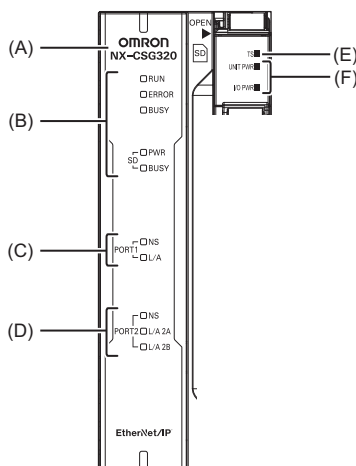

Letter	Name	Function
(A)	Model number display	Displays the model information of Communication Control Unit.
(B)	Communication Control Unit Status Indicators	The indicators show the current operating status of Communication Control Unit.
(C)	Built-in EtherNet/IP Status Indicators (PORT1)	The indicators show the communications status of Built-in EtherNet/IP Port (PORT1).
(D)	Built-in EtherNet/IP Status Indicators (PORT2)	The indicators show the communications status of Built-in EtherNet/IP Port (PORT2).
(E)	NX Bus Status Indicators	These indicators show the communications status with Communication Control Unit and NX Units.
(F)	Power Status Indicators	Show the power supply status of the Unit and I/O power supply.

## Safety Control Units

### Safety CPU Units NX-SL5500/SL5700

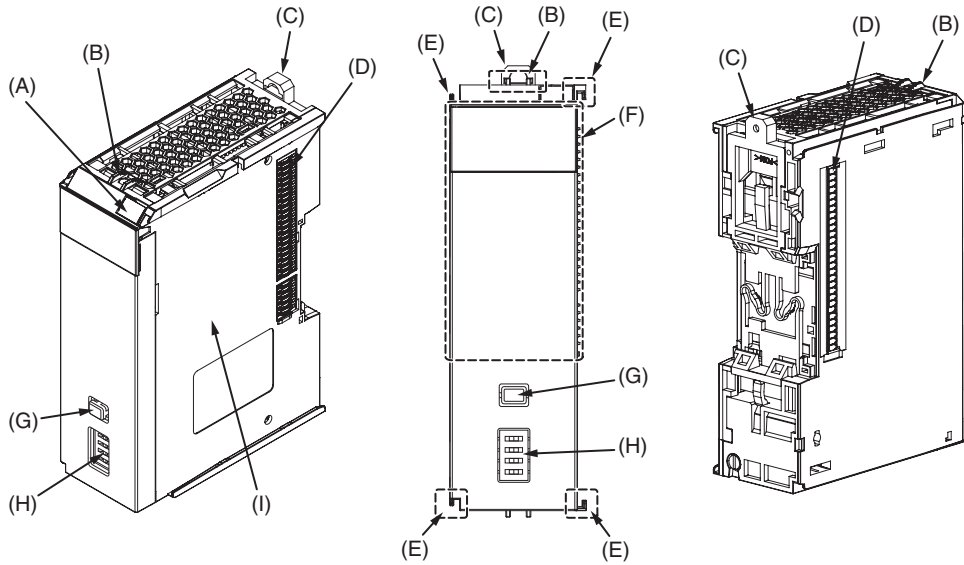

Letter	Name	Function
(A)	Marker attachment locations	The locations where markers are attached. The markers made by OMRON are installed for the factory setting. Commercially available markers can also be installed.
(B)	Protrusions for removing the Unit	The protrusions to hold when removing the Unit.
(C)	DIN Track mounting hook	This hook is used to mount the NX Unit to a DIN Track.
(D)	NX bus connector	This is the NX-series bus connector.
(E)	Unit hookup guides	These guides are used to connect two Units.
(F)	Indicators	The indicators show the current operating status and power supply status of the Safety CPU Unit.
(G)	Service switch	This switch is used for the start trigger of various functions.
(H)	DIP switch	This switch is used for the Safety Unit Restore and the safety data logging function.
(I)	Unit specifications	The specifications of the Safety CPU Unit are given.

### Indicators

The Safety CPU Unit has indicators that show the current operating status and communications status.

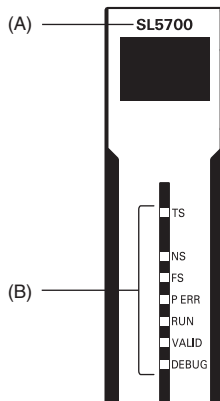

Letter	Name	Function
(A)	Model number display	Displays part of the model number of the Safety CPU Unit.
(B)	Indicators	Show the current operating status and communications status of the Safety CPU Unit.

**Safety Input Units NX-SIH400/SID800**  
**Safety Output Units NX-SOH200/SOD400**

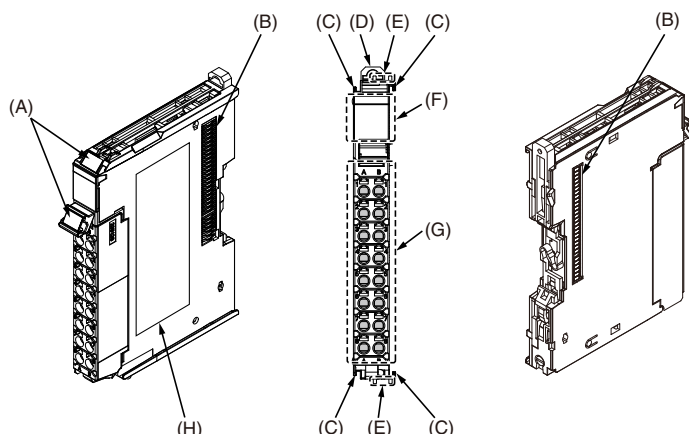

Letter	Item	Specification
(A)	Marker attachment locations	The locations where markers are attached. The markers made by OMRON are installed for the factory setting. Commercially available markers can also be installed.
(B)	NX bus connector	This is the NX-series bus connector. Connect this connector to another Unit, such as the NX-series Safety CPU Unit or a Safety I/O Unit.
(C)	Unit hookup guides	These guides are used to connect two Units.
(D)	DIN Track mounting hooks	These hooks are used to mount the NX Unit to a DIN Track.
(E)	Protrusions for removing the Unit	The protrusions to hold when removing the Unit.
(F)	Indicators	The indicators show the current operating status of the NX Unit or signal I/O status. The number of indicators varies depending on the NX Unit.
(G)	Terminal block	The terminal block is used to connect to external devices. It connects the safety outputs. The number of terminals depends on the NX Unit.
(H)	Unit specifications	The specifications of the NX Unit are given here.

**Terminal Blocks**

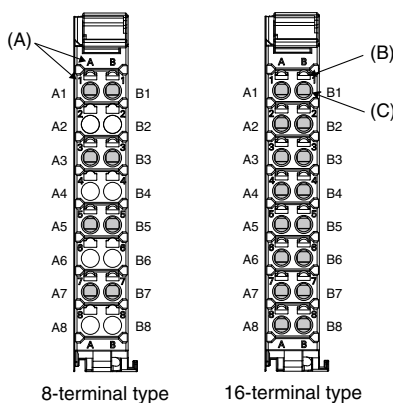

Letter	Item	Specification
(A)	Terminal number indications	The terminal numbers are given by column letters A and B, and row numbers 1 to 8. The combination of the column and row gives the terminal numbers from A1 to A8 and B1 to B8. The terminal number indicators are the same regardless of the number of terminals on the terminal block, as shown above.
(B)	Release holes	Insert a flat-blade screwdriver into these holes to connect and remove the wires.
(C)	Terminal holes	The wires are inserted into these holes.

**Applicable Terminal Blocks for Each Unit Model**

Unit model number	Terminal Blocks				
	Model	No. of terminals	Terminal number indications	Ground terminal mark	Terminal current capacity
NX-SIH400	NX-TBA082	8	A/B	None	10 A
NX-SID800	NX-TBA162	16	A/B	None	10 A
NX-SOH200	NX-TBA082	8	A/B	None	10 A
NX-SOD400	NX-TBA082	8	A/B	None	10 A

## Applicable Wires

### Using Ferrules

If you use ferrules, attach the twisted wires to them.

Observe the application instructions for your ferrules for the wire stripping length when attaching ferrules.

Always use plated one-pin ferrules. Do not use unplated ferrules or two-pin ferrules.

The applicable ferrules, wires, and crimping tool are given in the following table.

Terminal types	Manufacturer	Ferrule model number	Applicable wire (mm <sup>2</sup> (AWG))	Crimping tool
Terminals other than ground terminals	Phoenix Contact	A10,34-8	0.34 (#22)	Phoenix Contact (The figure in parentheses is the applicable wire size.) CRIMPFOX 6 (0.25 to 6 mm <sup>2</sup> , AWG24 to 10)
		A10,5-8	0.5 (#20)	
		A10,5-10		
		A10,75-8	0.75 (#18)	
		A10,75-10		
		A11,0-8	1.0 (#18)	
		A11,0-10		
		A11,5-8	1.5 (#16)	
A11,5-10				
Ground terminals		A12,5-10	2.0 *	
Terminals other than ground terminals	Weidmuller	H0.14/12	0.14 (#26)	Weidmuller (The figure in parentheses is the applicable wire size.) PZ6 Roto (0.14 to 6 mm <sup>2</sup> , AWG 26 to 10)
		H0.25/12	0.25 (#24)	
		H0.34/12	0.34 (#22)	
		H0.5/14	0.5 (#20)	
		H0.5/16		
		H0.75/14	0.75 (#18)	
		H0.75/16		
		H1.0/14	1.0 (#18)	
		H1.0/16		
		H1.5/14	1.5 (#16)	
H1.5/16				

\* Some AWG 14 wires exceed 2.0 mm<sup>2</sup> and cannot be used in the screwless clamping terminal block.

When you use any ferrules other than those in the above table, crimp them to the twisted wires so that the following processed dimensions are achieved.

Finished Dimensions of Ferrules

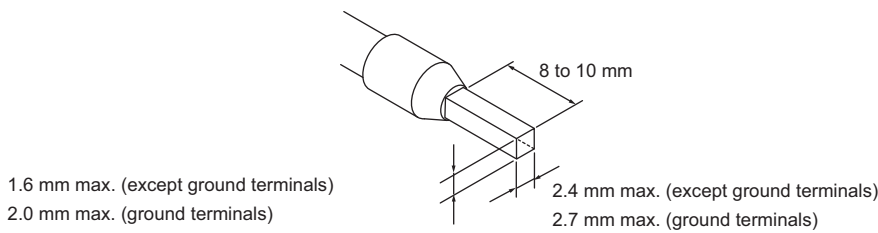

### Using Twisted Wires/Solid Wires

If you use the twisted wires or the solid wires, use the following table to determine the correct wire specifications.

Terminals		Wire type				Wire size	Conductor length (stripping length)
		Twisted wires		Solid wire			
Classification	Current capacity	Plated	Unplated	Plated	Unplated		
All terminals except ground terminals	2 A max.	Possible	Possible	Possible	Possible	0.08 to 1.5 mm <sup>2</sup> AWG28 to 16	8 to 10 mm
	Greater than 2 A and 4 A or less		Not Possible	Possible *1	Not Possible		
	Greater than 4 A		Possible *1	Not Possible	Not Possible		
Ground terminals	---	Possible	Possible	Possible *2	Possible *2	2.0 mm <sup>2</sup>	9 to 10 mm

\*1 Secure wires to the screwless clamping terminal block. Refer to the *Securing Wires* in the USER'S MANUAL (Cat. No. Z395) for how to secure wires.

\*2 With the NX-TB□□□1 Terminal Block, use twisted wires to connect the ground terminal. Do not use a solid wire.

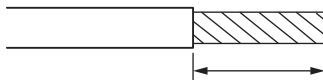

Conductor length (stripping length)

<Additional Information> If more than 2 A will flow on the wires, use plated wires or use ferrules.

## Selecting the Network Devices

### Recommended Ethernet Switches

We recommend products that have passed the ODVA's conformance tests for Managed Ethernet Switch Device Profile.

For more information, contact ODVA.

ODVA website: <https://www.odva.org>

### Recommended Twisted-pair Cables and Connectors

Applicable EtherNet/IP communications cables and connectors vary depending on the used baud rate.

For 100Base-TX and 10Base-T, use an STP (shielded twisted-pair) cable of category 5 or higher.

You can use either a straight or cross cable.

Cabling materials used for EtherNet/IP communication cables are shown in the table below.

100Base-TX in the Product name column of the table below indicates that either 100Base-TX or 10Base-T can be used.

Product name			Manufacturer	Model	
For 1000Base-T and 100Base-TX	Size and conductor pairs: AWG 24 × 4 pairs *	Cables	Hitachi Metals, Ltd.	NETSTAR-C5E SAB 0.5 × 4P CP	
			Kuramo Electric Co., Ltd.	KETH-SB	
			SWCC Showa Cable Systems Co., Ltd.	FAE-5004	
		RJ45 Connectors	Panduit Corporation	MPS588-C	
For 100Base-TX	Size and conductor pairs: AWG 22 × 2 pairs *	Cables	Kuramo Electric Co., Ltd.	KETH-PSB-OMR	
			JMACS Japan Co., Ltd.	PNET/B	
		RJ45 Assembly Connectors		OMRON	XS6G-T421-1

\* We recommend that you use cables and connectors in above combinations.

## Dimensions

(Unit: mm)

### Communication Control Unit NX-CSG320

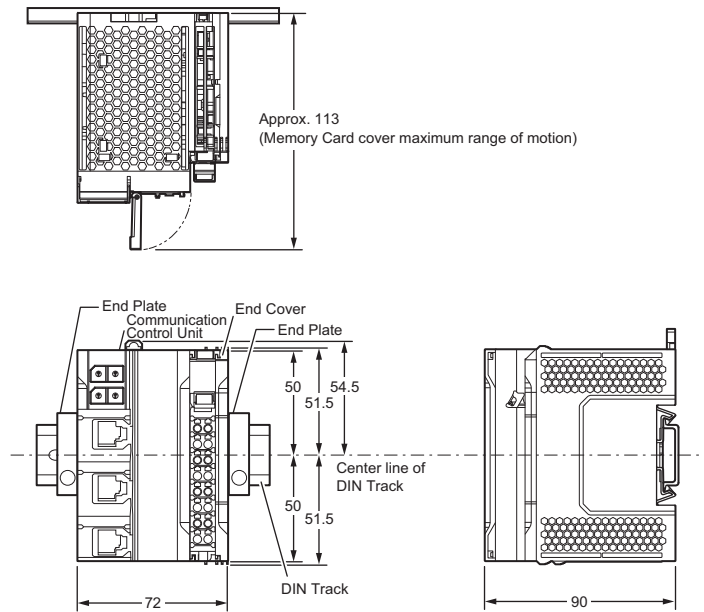

**Note:** For dimensions with the communications cable connected, refer to *NX-series User's Manual Safety Control Unit/Communication Control Unit* (Cat. No.Z395)

### Safety Control Units

#### Safety CPU Units NX-SL5500/SL5700

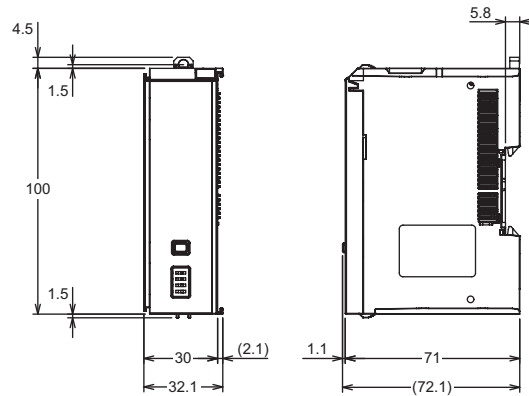

#### Safety Input Units NX-SIH400/SID800

#### Safety Output Units NX-SOH200/SOD400

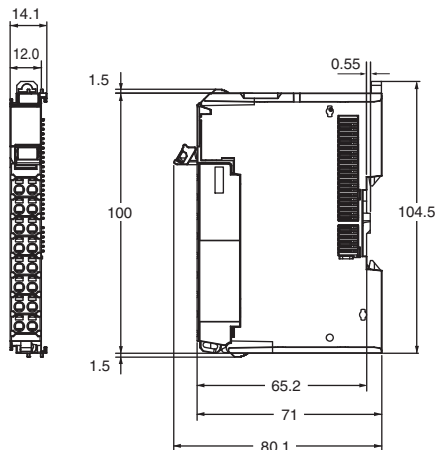

\*1. The dimension is 1.35 mm for Units with lot numbers through December 2014.

\*2. The dimension from the attachment surface of the DIN Track to the front surface of the Safety I/O Unit.



End Cover NX-END02

SD Memory Card HMC-SD291/SD491

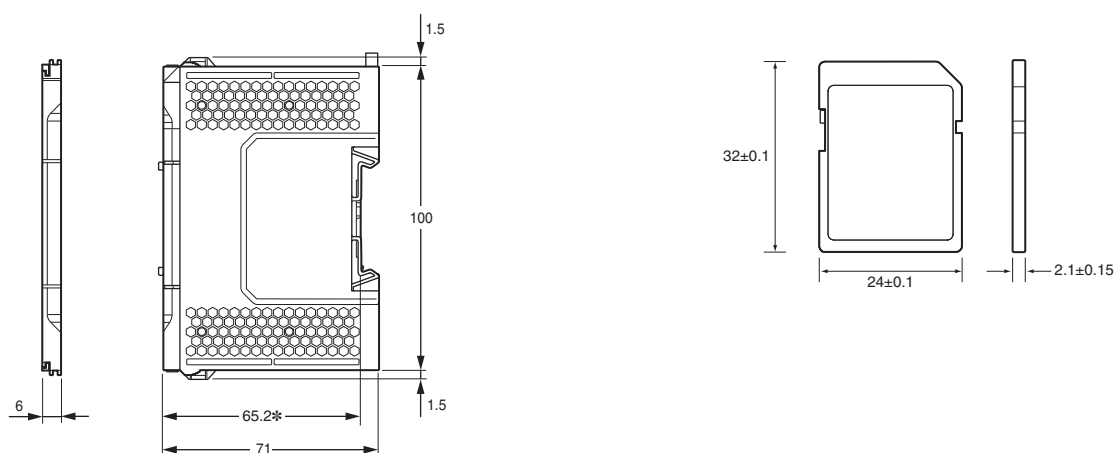

\* The dimension from the attachment surface of the DIN Track to the front surface of the end cover.

Related Manuals

Related Manuals	Cat. No.	Model numbers	Application	Description
NX-series Safety Control Unit / Communication Control Unit User's Manual	Z395	NX-SL5□□□ NX-SI□□□□ NX-SO□□□□ NX-CSG□□□□	Learning how to use the NX-series Safety Control Units and Communications Control Units.	Describes the hardware, setup methods, and functions of the NX-series Safety Control Units and Communications Control Units.
NX-series Communication Control Unit Built-in Function User's Manual	Z396	NX-CSG□□□□	Learning about the built-in functions of an NX-series Communications Control Unit.	Describes the software setup methods and communications functions of an NX-series Communications Control Unit.
NX-series Safety Control Unit Instructions Reference Manual	Z931	NX-SL□□□□	Learning about the specifications of instructions for the Safety CPU Unit.	Describes the instructions for the Safety CPU Unit.
NX-series Data Reference Manual	W525	NX-□□□□	Referencing lists of the data that is required to configure systems with NX-series Units.	Lists of the power consumptions, weights, and other NX Unit data that is required to configure systems with NX-series Units are provided.
Sysmac Studio Version 1 Operation Manual	W504	SYSMAC-SE2□□□□	Learning about the operating procedures and functions of the Sysmac Studio.	Describes the operating procedures of the Sysmac Studio.
NX-series System Units User's Manual	W523	NX-PD1□□□□ NX-PF0□□□□ NX-PC0□□□□ NX-TB□□□□X	Learning how to use NX-series System Units.	The hardware and functions of the NX-series System Units are described.

# Safety I/O Terminal GI-S Series

# GI-SMD/SID

## Safety I/O Terminals for CIP Safety™

- Support for CIP Safety on EtherNet/IP
- Standard-feature EtherNet/IP port
- Easy programming with Sysmac Studio



For the most recent information on models that have been certified for safety standards, refer to your local Omron website.

## Features

- Memory cassette for quick replacement of terminal
- Removable terminal block for easy maintenance
- Push-In Plus (screwless clamping) terminal block

### Quick replacement of terminal

#### ■ Memory cassette for quick replacement of terminal

Remove the memory cassette from the old terminal and install it into the new one to inherit the settings. No software is required.

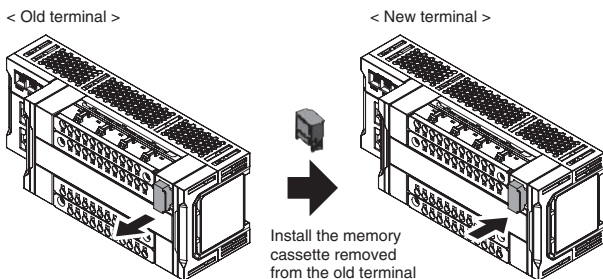

#### ■ Removable terminal block

Remove the wired terminal block from the old terminal and install it into the new one. No re-wiring is required.

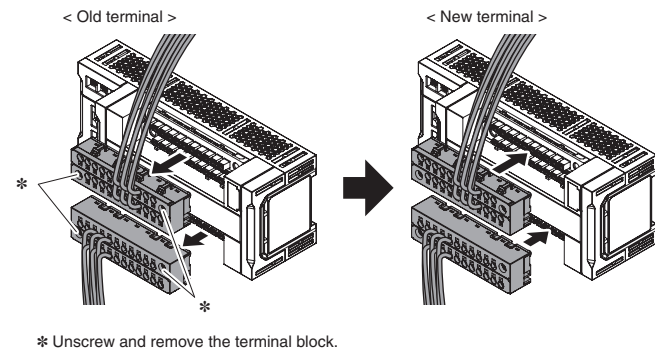

## Ordering Information

### GI-S-series safety I/O terminals **NEW**

Corresponding communication protocol	Specification		I/O capacity			Unit version	Model
	Number of connectors	Number of networks	Safety inputs	Test outputs	Safety outputs (for PNP)		
EtherNet/IP	2	1 *	12 inputs	12 outputs	4 outputs	Ver. 1.0	GI-SMD1624
			12 inputs	12 outputs	---	Ver. 1.0	GI-SID1224

\* PORT1 and PORT2 are ports with switching hub.

## Accessories

Not included.

- Sysmac and SYSMAC are trademarks or registered trademarks of OMRON Corporation in Japan and other countries for OMRON factory automation products.
- Microsoft, Windows, Windows Vista, Excel, and Visual Basic are either registered trademarks or trademarks of Microsoft Corporation in the United States and other countries.
- ODVA, CIP™, CompoNet™, DeviceNet™, EtherNet/IP™, and CIP Safety™ are trademarks of ODVA.
- The SD and SDHC logos are trademarks of SD-3C, LLC.

Other company names and product names in this document are the trademarks or registered trademarks of their respective companies.

## Specifications

### Regulations and Standards

#### GI-S-series safety I/O terminals

Certification body	Standards
TÜV Rheinland	<ul style="list-style-type: none"> <li>• EN ISO 13849-1</li> <li>• IEC 61508 parts 1-7</li> <li>• IEC/EN 62061</li> <li>• IEC/EN 61131-2</li> </ul>
UL	<ul style="list-style-type: none"> <li>• NRAG (UL 61010-1, UL 61010-2-201 and UL 121201)</li> <li>• NRAG7 (CSA C22.2 No. 61010-1, CSA C22.2 No. 61010-2-201 and CSA C22.2 No. 213)</li> </ul>

- The FSoE protocol was certified for applications in which OMRON FSoE devices are connected to each other. For compatibility with FSoE devices other than OMRON FSoE devices, the customer must validate FSoE communications.

By using GI-S-series safety I/O terminals, you can build a safety control system that meets the followings.

- Requirements for SIL 3 (Safety Integrity Level 3) in IEC 61508, IEC/EN 62061, (Functional Safety of Electrical/Electronic/Programmable Electronic Safety-related Systems)
- Requirements for PL<sub>e</sub> (Performance Level e) and for safety category 4 in EN ISO13849-1

Also, GI-S-series safety I/O terminals have been registered for conformity to RCM, EAC, and KC (Korean radio regulation).

### General Specifications

Item		Specification
<b>Enclosure</b>		Mounted in a panel (open type)
<b>Operating environment</b>	<b>Ambient operating temperature</b>	0 to 55°C
	<b>Ambient operating humidity</b>	10% to 95% (with no condensation or icing)
	<b>Atmosphere</b>	Must be free from corrosive gases
	<b>Ambient storage temperature</b>	-25 to 70°C (with no condensation or icing)
	<b>Altitude</b>	2,000 m max.
	<b>Pollution degree</b>	2
	<b>Insulation class</b>	CLASS III (SELV)
	<b>Overvoltage category</b>	II
	<b>EMC immunity level</b>	Zone B: IEC 61131-2
	<b>Vibration resistance</b>	Conforms to IEC 60068-2-6 5 to 8.4 Hz with amplitude of 3.5 mm 8.4 to 150 Hz, acceleration of 9.8 m/s <sup>2</sup> 100 min. in each X, Y, and Z directions (10 sweeps of 10 min. each = 100 min. total)
	<b>Shock resistance</b>	Conforms to IEC 60068-2-27 147 m/s <sup>2</sup> 3 times in each X, Y, and Z directions
	<b>Insulation resistance</b>	20 MΩ between isolated circuits (at 100 VDC)
<b>Dielectric strength</b>	500 VAC between isolated circuits for 1 minute at a leakage current of 10 mA max.	
<b>Installation method</b>		DIN Track mounting (IEC 60715 TH35-7.5/TH35-15)
<b>Degree of protection</b>		IP20

# GI-SMD/SID

## Individual Specifications

### GI-SMD1624/GI-SID1224

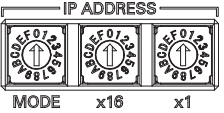
Model		GI-SMD1624	GI-SID1224
Number of safety input points		12	
Number of safety output points		4	---
Number of test output points		12	
OMRON special safety input device *1		Connection unavailable	
LED indication		[V0] LED, [IN□] LED x 12, [V1] LED, [OUT□] LED x 4, [MS] LED, [NS] LED, [PORT□ LINK] LED x 2	[V0] LED, [IN□] LED x 12, [V1] LED, [MS] LED, [NS] LED, [PORT□ LINK] LED x 2
Hardware switch setting		[IP ADDRESS] switch x3 (MODE, x16, x1)  * Factory default GI-SMD1624 : 192.168.250.2      [IP ADDRESS] Switch= "002" GI-SID1224 : 192.168.250.3      [IP ADDRESS] Switch= "003"	
Safety input type		IEC61131-2 type3 PNP (sinking inputs)	
Safety input current		6 mA max.	
Safety input ON voltage		11 VDC min.	
Safety input OFF voltage/OFF current		5 VDC max./1 mA max.	
Safety output type		Source output (for PNP)	
Safety output rated current		0.5 A max.	*2
Maximum total safety output current		2.0 A	
Safety output ON residual voltage		1.2 V max. (between V1 and each output terminal)	
Safety output OFF residual voltage		2.0 V max. (between G1 and each output terminal)	
Safety output leakage current		0.1 mA max.	
Test output type		Source output (for PNP)	
Test output rated current		0.7 A max.	
Maximum total test output current		5.0 A	
Test output ON residual voltage		1.2 V max. (between V0 and each output terminal)	
Test output leakage current		0.1 mA max.	
External dimensions *3		170 (W) x 65 (H) x 55 (D)	
Weight		400 g	
Number of communications that can be set between NX Units		254 ports max. *3	
Unit power supplies	Power supply voltage	24 VDC (20.4 to 28.8 VDC)	
	Current consumption *4	250 A max.	
	Inrush current	On cold start at normal temperature 50 A max., 0.1 ms max.	
	Power supply terminal current carrying capacity *5	5 A	
	Insulation type	No insulation: Between unit power supply terminal and internal circuit	
Output power supply	Power supply voltage	24 VDC (20.4 to 28.8 VDC)	
	Current consumption	50 A max.	
	Inrush current	On cold start at normal temperature 50 A max., 0.1 ms max.	
	Power supply terminal current carrying capacity *5	5 A	
	Insulation type	Photocoupler insulation	
External connection terminal	Communication connector	EtherNet/IP communication RJ45 x 2	
	Screwless clamp terminal block	Top terminal block Functional earthing Unit power supply Input/Test output Bottom terminal block Output power supply Output/Input/Test output	Top terminal block Functional earthing Unit power supply Input/Test output Bottom terminal block Input/Test output

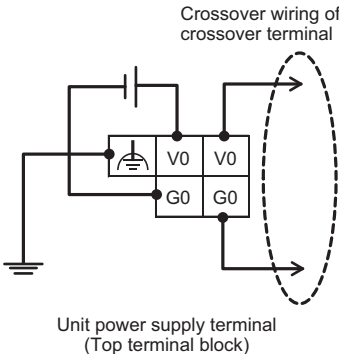
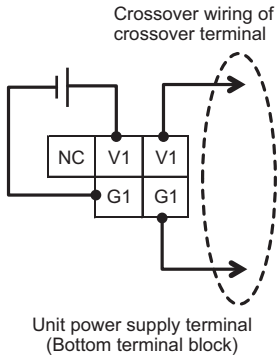
Model		GI-SMD1624	GI-SID1224
Inter-terminal connection diagram	V0/G0 Unit power supply		
	V1/G1 Output power supply		*2
Installation direction and restriction		No restriction	
Protective function		Overvoltage protection, overcurrent protection	

\*1. OMRON special safety input devices are the following input devices:

- Safety mat UMA, UM (The UM Series was discontinued at the end of June 2019.)
- Safety edge SGE
- Single-beam safety sensor E3ZS
- Non-contact door switch D40A, D40Z

\*2. GI-SID1224 has no output signal terminal and no output power supply is connected.

\*3. Projections are not included.

\*4. Inrush current when the supply power is turned ON from the static power-OFF state. Inrush current value may vary depending on conditions. For your selection of fuses, breakers, and external power supply units, take into account the conditions to be used to select those that have a margin in characteristics and capacity.

\*5. Current-carrying capacity allowed to continuously flow through the terminal. This current must not be exceeded in case crossover wiring is done for the unit power supply.

## GI-SMD/SID

### Built-in EtherNet/IP port specifications

This section describes the field bus specifications of the safety I/O terminal.

Item		Specifications	
		GI-SMD1624 / GI-SID1224	
Communications protocol		TCP/IP, UDP/IP	
Support services		Sysmac Studio connection, tag data links, CIP message communication, DHCP (client)	
Number of logical ports		1	
Physical layer		100BASE-TX	
Transmission specifications	Media access method	CSMA/CD	
	Modulation	Baseband	
	Transmission path	Star, daisy chain, mixed (star and daisy chain), ring (DLR)	
	Transmission rate	100M bit/s (100BASE-TX)	
	Transmission media	Twisted-pair cable (shielded: STP): category 5/5e or higher	
Transmission distance		100m max. (distance between hub and node)	
Number of cascaded connections		50 nodes or less recommended	
CIP messaging service: Explicit message UCMM (non-connection type)		Maximum number of clients that can communicate simultaneously: 8/Logical ports	
Safety process data communications	Exclusive Owner (EO)	Input	1
		Output	1
Standard process data communications	Input Only	1 (Point to Point)	
	Listen Only	7 (Multi-Cast)	
EtherNet/IP conformance test		CT9 compliant	
Ethernet interface		100BASE-TX Auto Negotiation Auto-MDI	
DLR (Device Level Ring)		Ring Node (Beacon-based)	

## Version Information

This section describes the combinations that can be used of the unit versions of the Safety CPU Unit and the Communication Control Unit, Machine Automation Controller, and the version of the Sysmac Studio.

Safety I/O Terminal		Supported Version					
Model	Unit Version	Safety CPU Unit NX-SL5700 NX-SL5500	Communication Control Unit NX-CSG320	Machine Automation Controller NX102-□□□□	Sysmac Studio	Network Configurator	Network Configurator for DeviceNet Safety
GI-SMD1624	Ver.1.0	Ver.1.3	Ver.1.01	Ver.1.31	Ver.1.24 or later	Ver.3.67 or later	Ver.3.42 or later
GI-SID1224	Ver.1.0	Ver.1.3	Ver.1.01	Ver.1.31	Ver.1.24 or later	Ver.3.67 or later	Ver.3.42 or later

## Component and Functions

This section describes the names and functions of the parts of the safety I/O terminal.

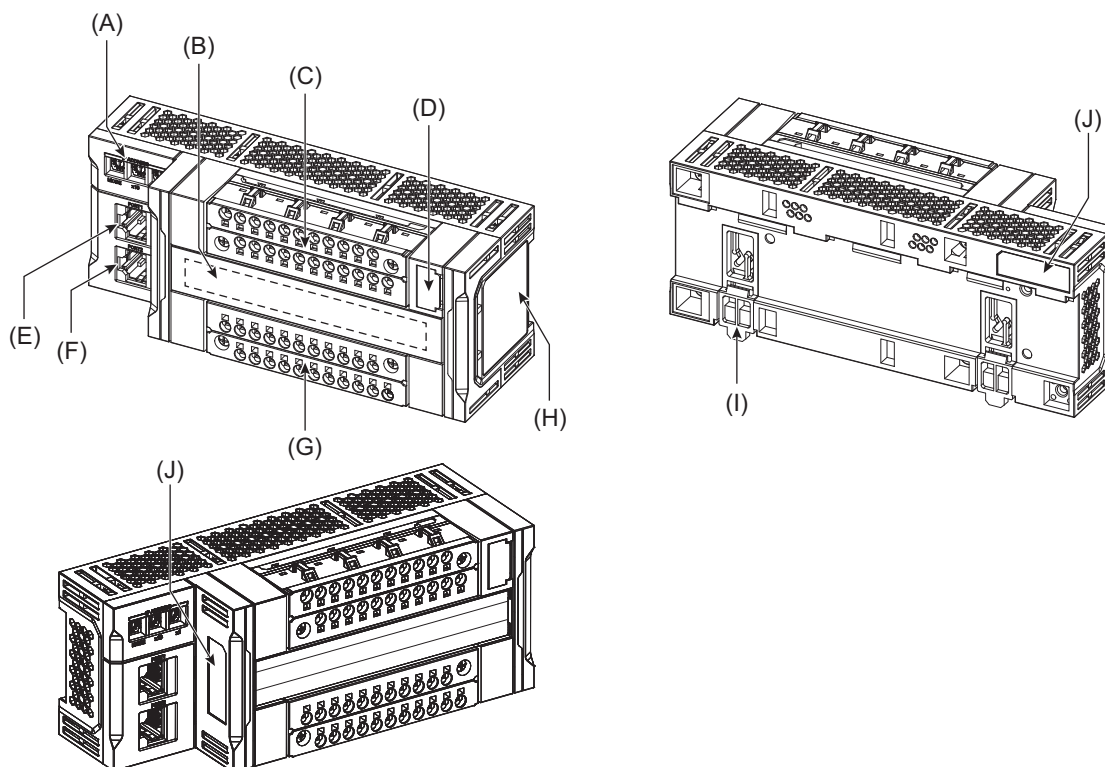

Symbol	Name	Description
A	Rotary switch	Used to set the mode switching and IP address of the built-in EtherNet/IP ports (PORT1/PORT2), in hexadecimal expression.
B	LED indicator	Shows the operation, signal, power supply and statuses of the safety I/O terminal itself by LED.
C	Top terminal block	Terminal block to connect unit power supply, grounding, and input devices.
D	Memory cassette slot	A memory cassette is set on delivery. The memory cassette allows a user to inherit the settings when replacing GI-S-series.
E	Built-in EtherNet/IP port (PORT1)	Connects the built-in EtherNet/IP with an Ethernet cable.
F	Built-in EtherNet/IP port (PORT2)	Connects the built-in EtherNet/IP with an Ethernet cable.
G	Bottom terminal block	Terminal block to connect output power supply and input/output devices. *
H	Unit specifications	Shows the product information, standards marking, and ID information (lot number/unit version) of the safety I/O terminal.
I	DIN Track mounting hooks	These hooks are used to mount the Unit to a DIN Track.
J	ID information indication	Shows the ID information (MAC address) of the safety I/O terminal.

\* Connection of output device is for GI-SMD1624 only.

# GI-SMD/SID

## Wiring

### Terminal arrangement

#### Top terminal block

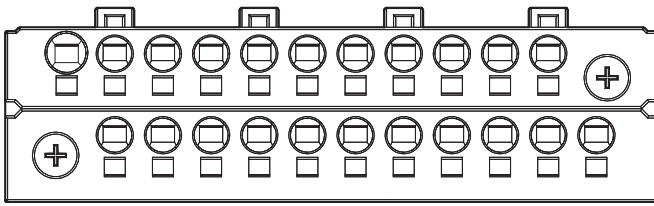

	V0	V0	IN0	IN1	IN2	IN3	IN4	IN5	IN6	IN7	
	G0	G0	T0	T1	T2	T3	T4	T5	T6	T7	NC

Symbol	Terminal name	Description
	Functional grounding	Functional grounding terminal to connect the grounding wire.
V0, G0	Unit power supply terminal	Terminal to connect the safety I/O terminal's power supply and to supply power to external devices. Power supply 24VDC is connected to V0 and 0VDC to G0, respectively. V0 and G0 terminals are internally connected.
IN0 - IN7	Input terminal	Terminal to connect a safety input device.
T0 - T7	Test output terminal	Terminal for test output.

#### Bottom terminal block

Arrangement differs for safety I/O terminal models.

##### a) GI-SMD1624

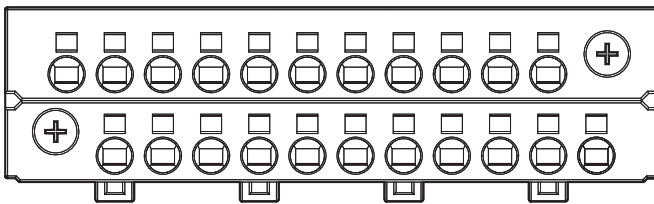

NC	V1	V1	G1	OUT0	OUT1	G1	IN8	IN9	IN10	IN11	
	G1	G1	G1	OUT2	OUT3	G1	T8	T9	T10	T11	NC

Symbol	Terminal name	Description
V1, G1	Output power supply terminal	Terminal to supply power to internal output control circuit and external devices. V1 and G1 terminals are internally connected.
OUT0 - OUT3	Output terminal	Terminal to connect a safety output device.
IN8 - IN11	Input terminal	Terminal to connect a safety input device.
T8 - T11	Test output terminal	Terminal for test output.

##### b) GI-SID1224

The terminal block form is same as a).

NC	V1	V1	G1	NC	NC	G1	IN8	IN9	IN10	IN11	
	G1	G1	G1	NC	NC	G1	T8	T9	T10	T11	NC

Symbol	Terminal name	Description
V1, G1	Output power supply terminal	V1 and G1 terminals are internally connected. GI-SID1224 is not connected to an output device and must not be wired.
NC	NC	Do not connect.
IN8 - IN11	Input terminal	Terminal to connect a safety input device.
T8 - T11	Test output terminal	Terminal for test output.



## Internal Circuit Diagram

GI-SMD1624

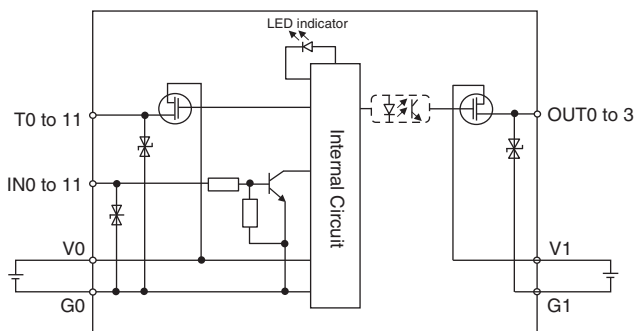

GI-SID1224

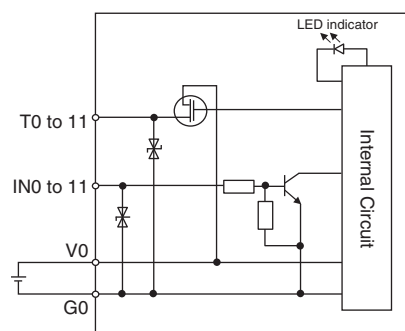

## Dimensions

(Unit: mm)

GI-SMD1624  
GI-SID1224

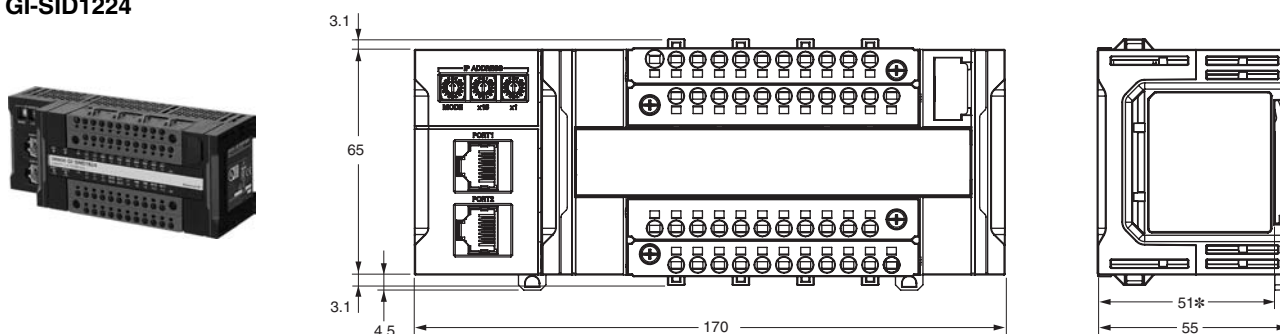

**Note:** For dimensions with the communications cable connected, refer to the *GI-S-series Safety I/O Terminal User's Manual*.  
\* This is a dimension from the DIN Track seat to the safety I/O terminal surface.

## Related Manuals

Manual name	Cat. No.	Model numbers	Application	Description
GI-S-series Safety I/O Terminal User's Manual	Z400	GI-S□□□□□□	Learning how to use the GI-S-series safety I/O terminals.	The hardware, setup methods, and functions of the GI-S-series safety I/O terminals are described.
NX-series Safety Control Unit / Communication Control Unit User's Manual	Z395	NX-SL5□□□□ NX-SI□□□□□ NX-SO□□□□□ NX-CSG□□□□	Learning how to use the NX-series Safety Control Units and Communications Control Units.	Describes the hardware, setup methods, and functions of the NX-series Safety Control Units and Communications Control Units.
NX-series NX102 CPU Unit Hardware User's Manual	W593	NX102-□□□□	Learning the basic specifications of the NX102 CPU Units, including introductory information, designing, installation, and maintenance. Mainly hardware information is provided.	An introduction to the entire NX102 system is provided along with the following information on the CPU Unit. <ul style="list-style-type: none"> <li>• Features and system configuration</li> <li>• Introduction</li> <li>• Part names and functions</li> <li>• General specifications</li> <li>• Installation and wiring</li> <li>• Maintenance and Inspection</li> </ul>
Sysmac Studio Version 1 Operation Manual	W504	SYSMAC-SE2□□□□	Learning about the operating procedures and functions of the Sysmac Studio.	Describes the operating procedures of the Sysmac Studio.

## Safety Precautions

Be sure to read the *Common Precautions for Safety Warning* at the following URL: <http://www.ia.omron.com/>.  
Be sure to read the following user's manual for other details required for correct use of the Safety I/O Terminals.

# Terms and Conditions Agreement

## **Read and understand this catalog.**

Please read and understand this catalog before purchasing the products. Please consult your OMRON representative if you have any questions or comments.

## **Warranties.**

- (a) Exclusive Warranty. Omron's exclusive warranty is that the Products will be free from defects in materials and workmanship for a period of twelve months from the date of sale by Omron (or such other period expressed in writing by Omron). Omron disclaims all other warranties, express or implied.
- (b) Limitations. OMRON MAKES NO WARRANTY OR REPRESENTATION, EXPRESS OR IMPLIED, ABOUT NON-INFRINGEMENT, MERCHANTABILITY OR FITNESS FOR A PARTICULAR PURPOSE OF THE PRODUCTS. BUYER ACKNOWLEDGES THAT IT ALONE HAS DETERMINED THAT THE PRODUCTS WILL SUITABLY MEET THE REQUIREMENTS OF THEIR INTENDED USE.

Omron further disclaims all warranties and responsibility of any type for claims or expenses based on infringement by the Products or otherwise of any intellectual property right. (c) Buyer Remedy. Omron's sole obligation hereunder shall be, at Omron's election, to (i) replace (in the form originally shipped with Buyer responsible for labor charges for removal or replacement thereof) the non-complying Product, (ii) repair the non-complying Product, or (iii) repay or credit Buyer an amount equal to the purchase price of the non-complying Product; provided that in no event shall Omron be responsible for warranty, repair, indemnity or any other claims or expenses regarding the Products unless Omron's analysis confirms that the Products were properly handled, stored, installed and maintained and not subject to contamination, abuse, misuse or inappropriate modification. Return of any Products by Buyer must be approved in writing by Omron before shipment. Omron Companies shall not be liable for the suitability or unsuitability or the results from the use of Products in combination with any electrical or electronic components, circuits, system assemblies or any other materials or substances or environments. Any advice, recommendations or information given orally or in writing, are not to be construed as an amendment or addition to the above warranty.

See <http://www.omron.com/global/> or contact your Omron representative for published information.

## **Limitation on Liability; Etc.**

OMRON COMPANIES SHALL NOT BE LIABLE FOR SPECIAL, INDIRECT, INCIDENTAL, OR CONSEQUENTIAL DAMAGES, LOSS OF PROFITS OR PRODUCTION OR COMMERCIAL LOSS IN ANY WAY CONNECTED WITH THE PRODUCTS, WHETHER SUCH CLAIM IS BASED IN CONTRACT, WARRANTY, NEGLIGENCE OR STRICT LIABILITY.

Further, in no event shall liability of Omron Companies exceed the individual price of the Product on which liability is asserted.

## **Suitability of Use.**

Omron Companies shall not be responsible for conformity with any standards, codes or regulations which apply to the combination of the Product in the Buyer's application or use of the Product. At Buyer's request, Omron will provide applicable third party certification documents identifying ratings and limitations of use which apply to the Product. This information by itself is not sufficient for a complete determination of the suitability of the Product in combination with the end product, machine, system, or other application or use. Buyer shall be solely responsible for determining appropriateness of the particular Product with respect to Buyer's application, product or system. Buyer shall take application responsibility in all cases.

NEVER USE THE PRODUCT FOR AN APPLICATION INVOLVING SERIOUS RISK TO LIFE OR PROPERTY OR IN LARGE QUANTITIES WITHOUT ENSURING THAT THE SYSTEM AS A WHOLE HAS BEEN DESIGNED TO ADDRESS THE RISKS, AND THAT THE OMRON PRODUCT(S) IS PROPERLY RATED AND INSTALLED FOR THE INTENDED USE WITHIN THE OVERALL EQUIPMENT OR SYSTEM.

## **Programmable Products.**

Omron Companies shall not be responsible for the user's programming of a programmable Product, or any consequence thereof.

## **Performance Data.**

Data presented in Omron Company websites, catalogs and other materials is provided as a guide for the user in determining suitability and does not constitute a warranty. It may represent the result of Omron's test conditions, and the user must correlate it to actual application requirements. Actual performance is subject to the Omron's Warranty and Limitations of Liability.

## **Change in Specifications.**

Product specifications and accessories may be changed at any time based on improvements and other reasons. It is our practice to change part numbers when published ratings or features are changed, or when significant construction changes are made. However, some specifications of the Product may be changed without any notice. When in doubt, special part numbers may be assigned to fix or establish key specifications for your application. Please consult with your Omron's representative at any time to confirm actual specifications of purchased Product.

## **Errors and Omissions.**

Information presented by Omron Companies has been checked and is believed to be accurate; however, no responsibility is assumed for clerical, typographical or proofreading errors or omissions.

- Sysmac is a trademark or registered trademark of OMRON Corporation in Japan and other countries for OMRON factory automation products.
- STI is a trademark or registered trademark of OMRON Corporation in Japan and other countries.
- Windows is a registered trademark of Microsoft Corporation in the USA and other countries.
- EtherCAT® is a registered trademark and patented technology, licensed by Beckhoff Automation GmbH, Germany.
- Safety over EtherCAT® is a registered trademark and patented technology, licensed by Beckhoff Automation GmbH, Germany.
- EtherNet/IP™, CIP Safety™, CompoNet™, and DeviceNet™ are trademarks of ODVA.
- The SD and SDHC logos are trademarks of SD-3C, LLC.
- Other company names and product names in this document are the trademarks or registered trademarks of their respective companies.
- Microsoft product screen shot(s) reprinted with permission from Microsoft Corporation.
- The product photographs and figures that are used in this catalog may vary somewhat from the actual products.
- Some images are used under license from Shutterstock.com.

## OMRON Corporation Industrial Automation Company

Kyoto, JAPAN

Contact: [www.ia.omron.com](http://www.ia.omron.com)

### Regional Headquarters

#### OMRON EUROPE B.V.

Wegalaan 67-69, 2132 JD Hoofddorp  
The Netherlands

Tel: (31)2356-81-300/Fax: (31)2356-81-388

#### OMRON ELECTRONICS LLC

2895 Greenspoint Parkway, Suite 200  
Hoffman Estates, IL 60169 U.S.A.

Tel: (1) 847-843-7900/Fax: (1) 847-843-7787

#### OMRON ASIA PACIFIC PTE. LTD.

No. 438A Alexandra Road # 05-05/08 (Lobby 2),  
Alexandra Technopark,  
Singapore 119967

Tel: (65) 6835-3011/Fax: (65) 6835-2711

#### OMRON (CHINA) CO., LTD.

Room 2211, Bank of China Tower,  
200 Yin Cheng Zhong Road,  
PuDong New Area, Shanghai, 200120, China

Tel: (86) 21-5037-2222/Fax: (86) 21-5037-2200

### Authorized Distributor:

© OMRON Corporation 2018-2019 All Rights Reserved.  
In the interest of product improvement,  
specifications are subject to change without notice.

**CSM\_1\_12\_0420**

**Cat. No. F104-E1-05**

1219 (0618)