

HENDO
LED TECHNOLOGIES

HENDO
LED TECHNOLOGIES



CONTACT INFORMATION:

4368 Corporate Dr, Burlington,
ONTARIO L7L 5R3,
Canada
www.hendoled.com

Email: sales@hendoled.ca

LED WORK LIGHTS
2023

7" LED WORK LIGHT 50W OSRAM



| MODEL | EL208 |
|--------------|---|
| SIZE | 7" (178x78x120mm) |
| POWER | 50W flood beam (10pcs 5W Osram) |
| RAW LUMEN | 6000LM |
| APPROVED | ECE R10, CE, UKCA |
| WARRANTY | 3 Years |
| VOLTAGE | 10-30V |
| CONNECTOR | DT Connector |
| WATERPROOF | IP67, IP69K |
| BRACKET | Stainless Steel |
| HOUSING | Die-cast Alu, PC Lens |
| WORKING TEMP | 5800K |
| PACKAGE | 12.45kg /carton, 12pcs, 44x29.5x35cm (45x31x36cm) |

4.3" LED WORK LIGHT 40W OSRAM



360° rotating Bracket

| MODEL | EL293F |
|--------------|--|
| SIZE | 4.3" (110X96X142mm) |
| POWER | 40W Flood beam (4pcs 10W Osram) |
| RAW LUMEN | 4800LM |
| APPROVED | ECE R10, CE, UKCA |
| WARRANTY | 3 Years |
| VOLTAGE | 10-30V |
| BRACKET | 360° Rotating bracket |
| WATERPROOF | IP67, IP69K |
| HOUSING | Die-cast Alu, PC Lens |
| WORKING TEMP | 5000K |
| LIFE TIME | Over 50000 hours |
| PACKAGE | 13.7kg /carton, 12pcs, 41.5x32.5x41cm (43x33x42cm) |

4" LED WORK LIGHT 5W OSRAW CHIP



3600LM
45W OSRAM



3600LM
45W OSRAM



4.2" & 5" LED WORK LIGHT 5W OSRAW CHIP



7500LM
80W OSRAM



8500LM
95W OSRAM



| MODEL | EL202 | EL203 |
|------------|-----------------------------------|-------------------------------|
| SIZE | 4.1" (105x105x46mm) | 3.9" (100x100x48mm) |
| POWER | 45W (9pcs 5W Osram) | 45W (9pcs 5W Osram) |
| RAW LUMEN | 3600LM | 3600LM |
| APPROVED | ECE R10, CE, CISPR 25 | ECE R10, CE, CISPR 25 |
| WARRANTY | 3 Years | 3 Years |
| VOLTAGE | 10-30V | 10-30V |
| PATTERN | Flood | Flood |
| CONNECTOR | 2 pin DT connector | 2 pin DT connector |
| WATERPROOF | IP67, IP69K | IP67, IP69K |
| BRACKET | Stainless Steel | Stainless Steel |
| HOUSING | Die-cast Alu, PC Lens | Die-cast Alu, PC Lens |
| PACKAGE | 12.2kg /carton, 20pcs, 37x35x28cm | 20pcs/ctn, 13.6kg, 37x35x28cm |

| MODEL | EL204 | EL206 |
|------------|--|-----------------------|
| SIZE | 4.2" (109x109x57mm) | 5.1" (130x60x160mm) |
| POWER | 80W (16pcs 5W Osram) | 95W (19pcs 5W Osram) |
| RAW LUMEN | 6500LM | 8500LM |
| APPROVED | ECE R10, CE, CISPR 25 | ECE R10, CE, CISPR 25 |
| WARRANTY | 3 Years | 3 Years |
| VOLTAGE | 10-30V | 10-30V |
| PATTERN | Flood | Flood |
| CONNECTOR | 2 pin DT Connector | 2 pin DT Connector |
| WATERPROOF | IP67, IP69K | IP67, IP69K |
| BRACKET | Stainless Steel | Stainless Steel |
| HOUSING | Die-cast Alu, PC Lens | Die-cast Alu, PC Lens |
| PACKAGE | 20pcs/ctn, 17.3kg, 36.5x33x26cm (38x35x27cm) | 20pcs/ctn |

LED WORK LIGHT 45W



| MODEL | EL2016 |
|--------------|-----------------------|
| SIZE | 4" |
| POWER | 45W |
| LUMEN | 3200LM |
| CERTIFICATES | CE, ECE |
| WARRANTY | 3 Years |
| VOLTAGE | 10-30V |
| PATTERN | Flood / Spot |
| WATERPROOF | IP68, IP69K |
| BRACKET | Stainless Steel |
| HOUSING | Die-cast Alu, PC Lens |
| PACKAGE | 20pcs/ctn |
| CARTONS | cm |

LED WORK LIGHT 54W



| MODEL | EL2018 |
|--------------|-----------------------|
| SIZE | 7" |
| POWER | 54W CREE |
| LUMEN | 4100LM |
| CERTIFICATES | CE, ECE R10 |
| WARRANTY | 3 Years |
| VOLTAGE | 10-30V |
| PATTERN | Flood / Spot |
| WATERPROOF | IP68, IP69K |
| BRACKET | Stainless Steel |
| HOUSING | Die-cast Alu, PC Lens |
| PACKAGE | 20pcs/ctn |
| CARTONS | cm |

4" LED ROUND WORK LIGHTS 10W Chip

10-80V Available



30W
10-60V

45W
10-60V

50W
10-80V

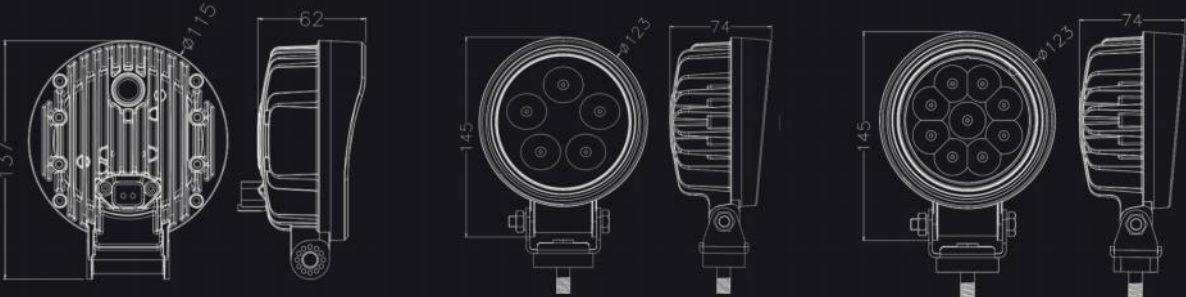

| MODEL | EL2045-30 | EL2045-45 | EL2045-50 |
|--------------|-------------------------------|-----------------------------|-----------------------------|
| SIZE | 4.5" (115x137x62mm) | 4.8" (123x145x74mm) | 4.8" (123x145x74mm) |
| POWER | 30W (6pcs 5W) | 45W (9pcs 5W) | 50W (5pcs 10W) |
| LUMEN | 3200LM | 4000LM | 4000LM |
| CERTIFICATES | CE, CISPR 25 | CE, CISPR 25 | CE, CISPR 25 |
| WARRANTY | 3 Years | 3 Years | 3 Years |
| VOLTAGE | 10-60V | 10-60V | 10-80V |
| PATTERN | Flood / Spot | Flood / Spot | Flood / Spot |
| CONNECTOR | Built-in DT connector | 0.35m Pig tail | 0.35m Pig tail |
| WATERPROOF | IP67, IP69K | IP67, IP69K | IP67, IP69K |
| BRACKET | Stainless Steel | Stainless Steel | Stainless Steel |
| HOUSING | Die-cast Alu, PC Lens | Die-cast Alu, PC Lens | Die-cast Alu, PC Lens |
| PACKAGE | 20pcs/ctn, 15kg, 35X32X26.5cm | 20pcs/ctn, 19kg, 37x31x21cm | 20pcs/ctn, 19kg, 37x31x21cm |

HEAVY DUTY LED WORK LIGHTS

10W CREE CHIP

R10  CISPR 25 C3



MODEL: EL2001 (40W)



MODEL: EL2002 (60W)



MODEL: EL2003 (90W)



MODEL: EL2004 (120W)



| MODEL | EL2001 | EL2002 | EL2003 | EL2004 |
|--------------|-----------------------|-----------------------|-----------------------|-----------------------|
| SIZE | 3" (97x120x75mm) | 4" (130x120x75mm) | 5" (130x150x78mm) | 6" (165x150x80mm) |
| POWER | 40W (4pcs 10W CREE) | 60W (6pcs 10W CREE) | 90W (9pcs 10W CREE) | 120W (12pcs 10W CREE) |
| LUMEN | 3600LM (2.75A@12V) | 5400LM (3.5A@12V) | 8100LM (6.2A@12V) | 10800LM (7.9A@12V) |
| CERTIFICATES | CE, ECE R10, CISPR 25 | CE, ECE R10, CISPR 25 | CE, ECE R10, CISPR 25 | CE, ECE R10, CISPR 25 |
| WARRANTY | 3 Years | 3 Years | 3 Years | 3 Years |
| VOLTAGE | 10-30V | 10-30V | 10-30V | 10-30V |
| PATTERN | Flood / Spot | Flood / Spot | Flood / Spot | Flood / Spot |
| CONNECTOR | Built-in DT connector | Built-in DT connector | Built-in DT connector | Built-in DT connector |
| WATERPROOF | IP67, IP69K | IP67, IP69K | IP67, IP69K | IP67, IP69K |
| BRACKET | Stainless Steel | Stainless Steel | Stainless Steel | Stainless Steel |
| HOUSING | Die-cast Alu, PC Lens | Die-cast Alu, PC Lens | Die-cast Alu, PC Lens | Die-cast Alu, PC Lens |
| PACKAGE | 20pcs/ctn, 17.8kg | 20pcs/ctn, 22.4kg | 12pcs/ctn, 18.5kg | 12pcs/ctn, 23.3kg |
| CARTONS | 56X25X23cm | 28x32x58cm | 42X31X32.5cm | 47X42X35.5cm |

LED WORK LIGHTS

50W / 80W / 70W



| MODEL | EL2013 | EL2014 | EL2015 |
|--------------|-----------------------|-----------------------|-----------------------|
| SIZE | 4" | 5" | 5" |
| POWER | 50W | 80W | 70W |
| LUMEN | 3000LM | 4800LM | 4200LM |
| CERTIFICATES | CE | CE | CE |
| WARRANTY | 3 Years | 3 Years | 3 Years |
| VOLTAGE | 10-30V | 10-30V | 10-30V |
| PATTERN | Flood / Spot | Flood / Spot | Flood / Spot |
| WATERPROOF | IP68, IP69K | IP68, IP69K | IP68, IP69K |
| BRACKET | Stainless Steel | Stainless Steel | Stainless Steel |
| HOUSING | Die-cast Alu, PC Lens | Die-cast Alu, PC Lens | Die-cast Alu, PC Lens |
| PACKAGE | 12pcs/ctn | 6pcs/ctn | 8pcs/ctn |
| CARTONS | 34.5x32x28cm | 35.5x31x21.5cm | 43x37.5x35.5cm |

HEAVY DUTY LED WORK LIGHTS

27W, 60W, 90W, 120W



Part No.: EL2081-27



Part No.: EL2081-60



Part No.: EL2081-90



Part No.: EL2081-100

| MODEL | EL2081-27 | EL2081-60 | EL2081-90 | EL2081-100 |
|--------------|-----------------------|-----------------------|-----------------------|-----------------------|
| SIZE | 4.3" (108*138*72) | 5" (125*113*103) | 6.4" (160*141*115.4) | 6.4" (160*141*115.4) |
| POWER | 27W CREE | 60W CREE | 90W CREE | 100W CREE |
| LUMEN | 2160LM | 4800LM | 7200LM | 8000LM |
| CERTIFICATES | CE, ECE R10 | CE, ECE R10 | CE, ECE R10 | CE, ECE R10 |
| WARRANTY | 3 Years | 3 Years | 3 Years | 3 Years |
| VOLTAGE | 10-30V | 10-30V | 10-48V | 10-30V |
| PATTERN | Flood / Spot | Flood / Spot | Flood / Spot | Flood / Spot |
| WATERPROOF | IP68, IP69K | IP68, IP69K | IP68, IP69K | IP68, IP69K |
| BRACKET | Stainless Steel | Stainless Steel | Stainless Steel | Stainless Steel |
| HOUSING | Die-cast Alu, PC Lens | Die-cast Alu, PC Lens | Die-cast Alu, PC Lens | Die-cast Alu, PC Lens |
| PACKAGE | 20pcs/ctn | 12pcs/ctn | 8pcs/ctn | 8pcs/ctn |
| CARTONS | 20kg, 42x26x33cm | | 22kg, 41.5x41x32cm | 41.5x41x32cm |

LED HEADLIGHT HIGH BEAM, LOW BEAM, INDICATOR, DRL

Two different installation directions, bottom installation, back installation





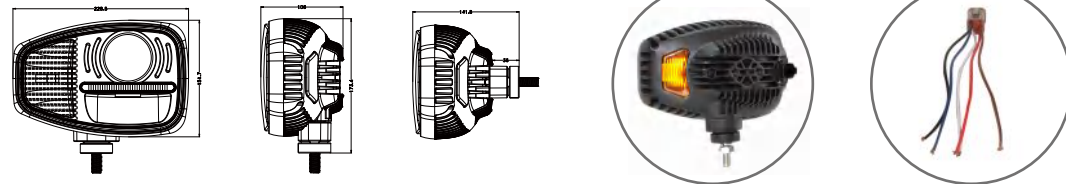

 ECE R112 R6 R87

 DOT FMVSS 108

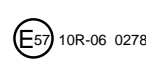

| MODEL | EL111 |
|--------------|--|
| SIZE | 228x151x106mm |
| POWER | Low beam: 30W, high beam: 60W |
| LUMEN | Low beam: 2400LM, high beam: 5600LM, DI: 6W, DRL: 6W |
| CERTIFICATES | DOT FMVSS 108, ECE R112, R6 R87, CE |
| VOLTAGE | 10-30V |
| PATTERN | High beam, low beam, DI, DRL |
| CONNECTOR | Built-in 6 pin DT Connector |
| WATERPROOF | IP67, IP69K |
| BRACKET | Stainless Steel |
| HOUSING | Die-cast Aluminum housing, PC Lens |
| PACKAGE | 2pairs/ctn, 10.4kg |
| CARTONS | 56X53X16cm |

Scene Light with Flashing Light 2-in-1



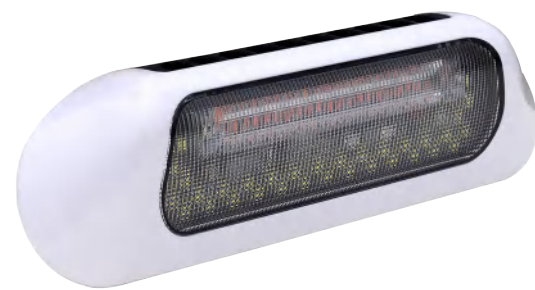





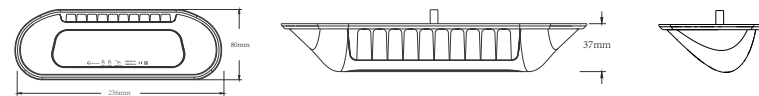

SL1-1
 Scene Light with Flashing Light
 With Synchronization & Asynchronous
 Warning Color option: ●●●○
 ECE R65 R10 SAE approved



SL1-3
 Scene Light
 4500LM



Product Video:
<https://youtu.be/iU43SE2CwYI>



| MODEL | SL1-1 | SL1-3 |
|---------------------|--|--|
| Size | 236x80x37mm | 236x80x37mm |
| Scene Light Power | 32W | 48W & 20W |
| Warning Light Power | 12W | - |
| Raw Lumen | 3500LM | 4500LM |
| Scene Light Angle | Down 45° | Down 45° |
| Warning Light angle | Horizontal 180° | - |
| Waterproof | IP67, IP69K | IP67, IP69K |
| Flashing patterns | 13 Patterns | - |
| Approval | ECE R65 TA1 TB2, ECE R10, R148, CE, UKCA | ECE R10, R148 CE, CA, CISPR 25 Class 4 |
| Voltage | 10-30V | 10-30V |
| Housing Material | Aluminium Housing, PC Cover | Aluminium Housing, PC Cover |
| Lens Material | UV resistant PC Lens | UV resistant PC Lens |
| Warranty | 3 Years | 3 Years |
| Package | 10pcs/ctn, 4.4kg, 44x27x21.5cm | 10pcs/ctn, 4.4kg, 44x27x21.5cm |

Loding & Unloading At any time any where!

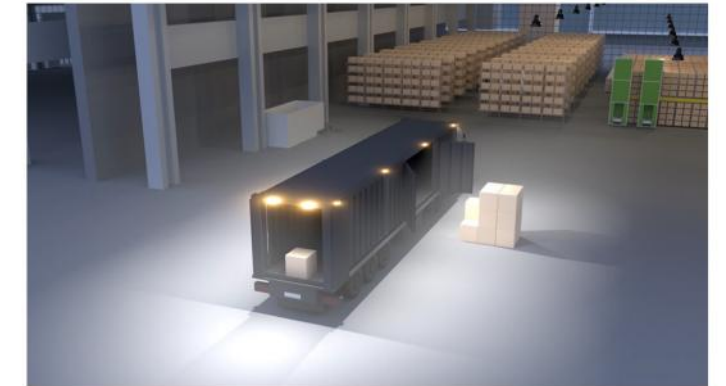

Auxiliary Turn Signal



When turning left
 All lights on the left will turn on simultaneously with the left turn signal

When turning Right
 All lights on the right will turn on simultaneously with the right turn signal



Anti-icing Snowplow light

High beam, Low beam, Indicator, DRL, With heating lens

Automatic Snow-melt and anti-icing system



-  HEATING LENS
-  ECE R112 R6 R87
-  DOT FMVSS 108

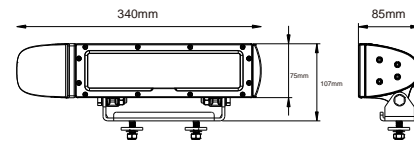
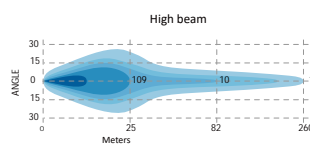
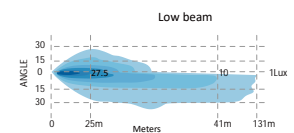

| MODEL | EL113 |
|--------------|--|
| SIZE | 340x85x107mm |
| POWER | Low beam: 20W, high beam: 40W |
| LUMEN | Low beam: 1800LM, high beam: 3600LM, DI: 18W, position light: 3W |
| CERTIFICATES | DOT FMVSS 108, ECE R112, R6 R7, CE |
| WARRANTY | 3 Years |
| VOLTAGE | 10-30V |
| PATTERN | High beam, low beam, DI, position light |
| CONNECTOR | Built-in 6 pin DT Connector |
| WATERPROOF | IP67, IP69K |
| BRACKET | Stainless Steel |
| HOUSING | Die-cast Aluminum housing, PC Lens |
| PACKAGE | 2pairs/ctn, 11kg, 41x34x25cm |

Anti-icing Snowplow light

High beam, Low beam, Indicator, DRL, With heating lens

Automatic Snow-melt and anti-icing system

-  HEATING LENS
-  ECE R112 R6 R87
-  DOT FMVSS 108

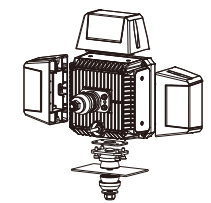

| MODEL | EL117 |
|--------------|--|
| SIZE | 215x150x85mm |
| POWER | Low beam: 35W, high beam: 65W |
| LUMEN | Low beam: 2500LM, high beam: 4500LM, DI: 18W, position light: 3W |
| CERTIFICATES | DOT FMVSS 108, ECE R112, R6 R7, CE |
| WARRANTY | 3 Years |
| VOLTAGE | 10-30V |
| PATTERN | High beam, low beam, DI, position light |
| CONNECTOR | Built-in 6 pin DT Connector |
| WATERPROOF | IP67, IP69K |
| BRACKET | Stainless Steel |
| HOUSING | Die-cast Aluminum housing, PC Lens |
| PACKAGE | 2pcs/ctn, 11kg, 53.5x30.5x27cm |

3" Mini LED Work Lights

Small but Powerful

10-60V Available

MINI



2800LM
42W



3000LM
48W

| MODEL | EL2041 | EL2042 |
|------------|-----------------------------------|-----------------------------------|
| SIZE | 3" (90x107x50mm) | 3" (123x145x74mm) |
| POWER | 42W (14pcs High power 3W Chip) | 48W (16pcs high power 3W Chip) |
| LUMEN | 2800LM | 3000LM |
| APPROVED | CE, ECE | CE, ECE |
| WARRANTY | 3 Years | 3 Years |
| VOLTAGE | 10-60V | 10-60V |
| PATTERN | Flood / Spot | Flood / Spot |
| CONNECTOR | 0.35m Pig tail | 0.35m Pig tail |
| WATERPROOF | IP68, IP69K | IP67, IP69K |
| BRACKET | Stainless Steel | Stainless Steel |
| HOUSING | Aluminum, PC | Aluminum, PC |
| PACKAGE | 50pcs/ctn, 52.5x34x24.5cm, 20.3kg | 50pcs/ctn, 52.5x34x24.5cm, 22.2kg |

RECHARGEABLE LED WORK LIGHTS

FLOOD & STROBE

Fully charge the battery and still have 90% remaining power after one year of non-use
Smart protection system: over-charging protection, over-discharge protection and short circuit protection

CE ROHS, FCC, PSE



2200mAh



8000mAh



10000mAh

Video link:
https://youtu.be/i290bxb3L_o

| MODEL | EL251 | EL256 | EL253 |
|---------------|---------------------------|-----------------------------|---|
| SIZE | 3" | 4" | 5" |
| POWER | 15W | 16W | 27W (White + Blue + Red LED) |
| LUMEN | 1100LM | 1400LM | 2700LM |
| BATTERY | 3.6V 2200mAh | 3.6V 8000mAh | 7.4V 10000mAh 18650 Lithium |
| WORKING HOURS | 4-5 hours | 4-8 hours | 8-16 hours |
| RECHARGING | 4 hours | 4 hours | 5.5 hours |
| CERTIFICATES | CE ROHS FCC PSE | CE ROHS FCC PSE | CE ROHS FCC PSE |
| WARRANTY | 1 Years | 1 Years | 1 Years |
| PATTERN | 100%, 30% brightness, SOS | 100%, 30% brightness, SOS | 100%, 30% brightness, Blue + Red Strobe |
| MOUNTING | Magnet base | Strong Magnet base | Strong Magnet base |
| MATERIAL | ABS, PC Lens | ABS, PC Lens | ABS, PC Lens |
| PACKAGE | 10pcs/ctn | 10pcs, 8.5kg, 640x300x221cm | 12pcs/ctn, 18kg, 440x330x490cm |

LED Work Light



Model: EL247 (18W)



Model: EL224 (24W)



Model: EL226 (27W)



Model: EL254 (42W)



Model: EL214 (24W)



Model: EL229 (27W)



Model: EL234 (48W)



Model: EL235 (48W)



Model: EL225 (24W)



Model: EL219 (36W)



Model: EL2102 (54W)



Model: EL265 (65W)



Model: EL258 (15W)



Model: EL229H (27W)



Model: EL234H (48W)



Model: EL238 (24W)



Model: EL263 (45W)



Model: EL2031 (45W)



Model: EL241 (18W)



Model: EL259A



Model: EL223 (12W)



Model: EL249 (30W)



Model: EL272 (60W)



Model: EL273 (90W)



HENDO
LED TECHNOLOGIES

HENDO
LED TECHNOLOGIES



**LED WARNING LIGHTS
2023**

LED Beacon ECE TA2 TB2

R65 R10 CISPR 25 C4



| MODEL | B5 | B6 | B7 |
|-------------------|-----------------------------|-----------------------------|-----------------------------|
| Size | 111x111x54.6mm | 124x124x89mm | 124x124x127mm |
| Power | 36W (24pcs 1.5W) | 48W (48pcs 1W) | 96W (96pcs 1W) |
| Certificate | ECE R65 TA2, R10, SAE | ECE R65 TA2, R10, SAE | ECE R65 TA2, R10, SAE |
| Anti-shock rating | 60G | 60G | 60G |
| Flash pattern | 13 Patterns | 13 Patterns | 13 Patterns |
| SYNC | with SYNC & ASYNC function | with SYNC & ASYNC function | with SYNC & ASYNC function |
| Waterproof | IP68, IP69K | IP68, IP69K | IP68, IP69K |
| Voltage | 10-30V | 10-30V | 10-30V |
| Material | Die-cast housing, PC Lens | Die-cast housing, PC Lens | Die-cast housing, PC Lens |
| Warranty | 3 Years | 3 Years | 3 Years |
| Package | 10pcs/ctn | 8pcs/ctn | 8pcs/ctn |
| Mounting | (Bolt Mount) (Magnet mount) | (Bolt Mount) (Magnet mount) | (Bolt Mount) (Magnet mount) |

Synchronized Flash available

Asynchronized Flash available

| | |
|---|--------------|
| Positive | Red Cable |
| Negative Ground | Black Cable |
| Synchronized flash & patterns selection | Yellow Cable |
| Asynchronized flash | Green Cable |

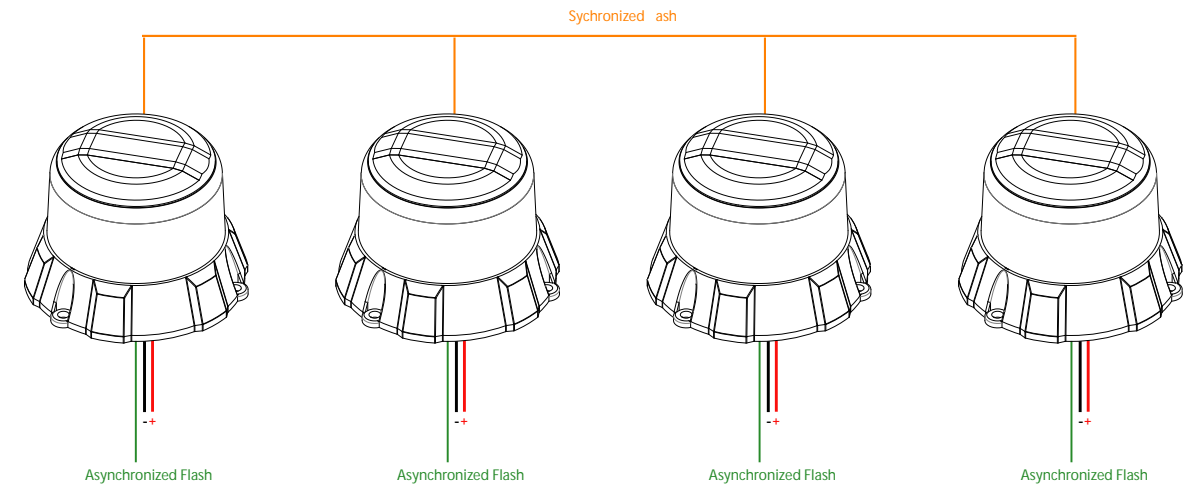

60G Shock Test Video

<https://youtu.be/7PNrlqyQk1k>



IP6K9K Waterproof Test Video

<https://youtu.be/crVqiC5EI5I>



Din Mount is also available



Black Housing is available

black top and black base



LED Beacon Dual Color, Amber & Blue & Red Mixed



| MODEL | B5d | B6d | B7d |
|-------------------|-----------------------------|-----------------------------|-----------------------------|
| Size | 111x111x54.6mm | 124x124x89mm | 124x124x127mm |
| Power | 36W (24pcs 1.5W) | 48W (48pcs 1W) | 96W (96pcs 1W) |
| Certificate | ECE R65 TA2, R10, SAE | ECE R65 TA2, R10, SAE | ECE R65 TA2, R10, SAE |
| Anti-shock rating | 60G | 60G | 60G |
| Flash pattern | 19 Patterns | 19 Patterns | 19 Patterns |
| SYNC | with SYNC & ASYNC function | with SYNC & ASYNC function | with SYNC & ASYNC function |
| Waterproof | IP68, IP69K | IP68, IP69K | IP68, IP69K |
| Voltage | 10-30V | 10-30V | 10-30V |
| Material | Die-cast housing, PC Lens | Die-cast housing, PC Lens | Die-cast housing, PC Lens |
| Warranty | 3 Years | 3 Years | 3 Years |
| Package | 10pcs/ctn | 8pcs/ctn | 8pcs/ctn |
| Mounting | (Bolt Mount) (Magnet mount) | (Bolt Mount) (Magnet mount) | (Bolt Mount) (Magnet mount) |

Wiring Instruction For Bolts Mounting Version

| | |
|------------------------|---|
| Color 1 Positive + | Red wire |
| Color 2 Positive + | White wire |
| Negative Ground - | Black wire |
| Flash Pattern and SYNC | Yellow wire (Momentarily touch for next pattern, touch for 5 second go back to 1st pattern) |
| Asynchronous | Green wire |

Synchronized Flash Setting

1. Connect all the Yellow wires together, and touch the Yellow wires to the positive for 5 seconds, and then all the lights will go back to the first flash pattern and will flash in sync.
2. Momentarily touch the Yellow wires to the positive for next pattern.

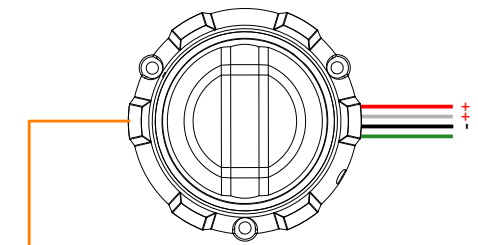

Asynchronous Flash Setting

1. Connect all the Yellow wires together, and touch the Yellow wires to the positive for 5 seconds, and then all the lights will go back to the first flash pattern and will flash in SYNC.
2. Momentarily touch the Yellow wires to the positive for next pattern.
3. Connect all the Green wires of all the lights you want to be asynchronous to the positive +, and the lights will flash asynchronously.

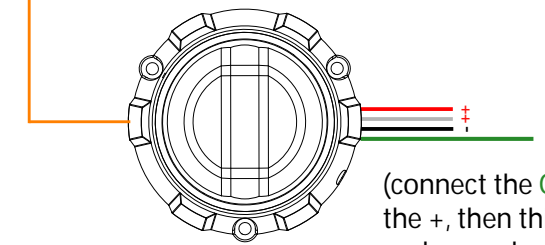

(connect the Green wire to the +, then this light will flash asynchronously)

B5 Video

Synchronized Flash & Asynchronized Flash
<https://youtu.be/2Rvxxo3wdBo>



B6 B7 Video

Synchronized Flash & Asynchronized Flash
<https://youtu.be/NkPiZnVy7rI>



LED Beacon Blue Version

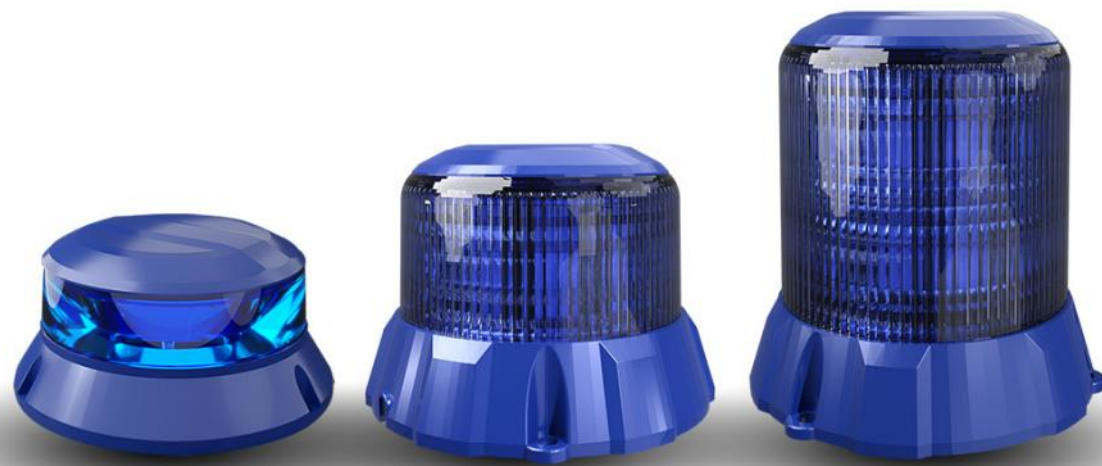

| MODEL | B5b | B6b | B7b |
|--------------------------|-----------------------------|-----------------------------|-----------------------------|
| Size | 111x111x54.6mm | 124x124x89mm | 124x124x127mm |
| Power | 36W (24pcs 1.5W) | 48W (48pcs 1W) | 96W (96pcs 1W) |
| Certificate | ECE R65 TB2, R10, SAE | ECE R65 TB1, R10, SAE | ECE R65 TA1, R10, SAE |
| Anti-shock rating | 60G | 60G | 60G |
| Flash pattern | 12 Patterns | 12 Patterns | 12 Patterns |
| SYNC | with SYNC & ASYNC function | with SYNC & ASYNC function | with SYNC & ASYNC function |
| Waterproof | IP68, IP69K | IP68, IP69K | IP68, IP69K |
| Voltage | 10-30V | 10-30V | 10-30V |
| Material | Die-cast housing, PC Lens | Die-cast housing, PC Lens | Die-cast housing, PC Lens |
| Warranty | 3 Years | 3 Years | 3 Years |
| Package | 10pcs/ctn | 8pcs/ctn | 8pcs/ctn |
| Mounting | (Bolt Mount) (Magnet mount) | (Bolt Mount) (Magnet mount) | (Bolt Mount) (Magnet mount) |

LED Beacon Red Version



| MODEL | B5r | B6r | B7r |
|--------------------------|-----------------------------|-----------------------------|-----------------------------|
| Size | 111x111x54.6mm | 124x124x89mm | 124x124x127mm |
| Power | 36W (24pcs 1.5W) | 48W (48pcs 1W) | 96W (96pcs 1W) |
| Certificate | ECE R65 TR1, R10, SAE | R10, SAE | R10, SAE |
| Anti-shock rating | 60G | 60G | 60G |
| Flash pattern | 12 Patterns | 12 Patterns | 12 Patterns |
| SYNC | with SYNC & ASYNC function | with SYNC & ASYNC function | with SYNC & ASYNC function |
| Waterproof | IP68, IP69K | IP68, IP69K | IP68, IP69K |
| Voltage | 10-30V | 10-30V | 10-30V |
| Material | Die-cast housing, PC Lens | Die-cast housing, PC Lens | Die-cast housing, PC Lens |
| Warranty | 3 Years | 3 Years | 3 Years |
| Package | 10pcs/ctn | 8pcs/ctn | 8pcs/ctn |
| Mounting | (Bolt Mount) (Magnet mount) | (Bolt Mount) (Magnet mount) | (Bolt Mount) (Magnet mount) |

1200mm Roof Rack Bars

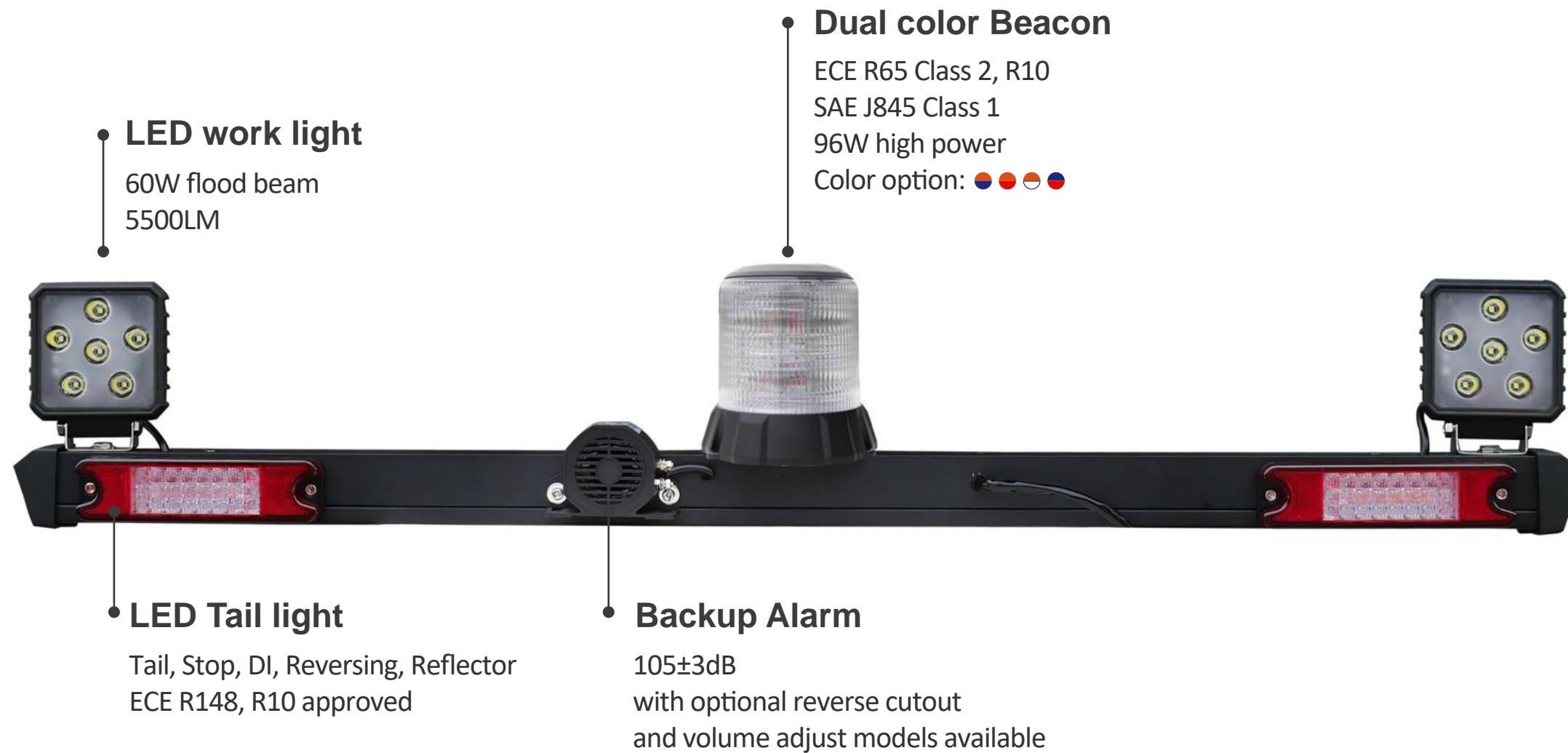

Huge range of applicaton

the roof rack Bar range can be customised to suit service vehicles, mining vehicles, construction and earth-moving machinery, plus contractor and tradesmen's vehicles. The bars can also be used as roof racks to carry equipment such as ladders, pipes and other materials.



| | |
|----------------|-------------|
| MODEL: | C5 |
| LENGTH | 47" |
| SIZE | 1200mm |
| MATERIAL | Aluminum |
| VOLTAGE | 12-24V |
| FLASH PATTERNS | 13 Patterns |
| WATERPROOF | IP67, IP69K |
| MOUNT | Screws |
| PACKAGE | 1 piece/ctn |

Warning Lights With Alarm 2-in-1

Warning Light and Backup alarm can work together or separately

Sound Level: 102DB, 10-30V available



5 functions:

- Daytime Reversing Mode-----Alarm + Warning Light
- Night Reversing Mode-----Alarm + Warning Light
- Night Reversing Mode-----Warning Light only
- Only Alarm Mode
- Only Warning Light Mode

3 functions:

- Warning Light Work only
- Alarm Work only
- Warning Light & Alarm Work Synchronously

| MODEL | EL5721 | EL5722 |
|---------------|-------------------|--|
| SIZE | 102x102x43mm | 141x141x105mm |
| POWER | 12W | 36W |
| SOUND LEVEL | 102DB | 107DB |
| CERTIFICATES | ECE R65, R10, SAE | ECE R65, R10, SAE |
| FLASH PATTERN | Dual Flashing | Single Flashing / Dual Flashing / Rotating |
| WATERPROOF | IP65 | IP65 |
| VOLTAGE | 10-30V | 10-30V |
| MATERIAL | Nylon housing | PC housing |
| WARRANTY | 3 Years | 3 Years |
| PACKAGE | 10pcs/ctn | 10pcs/ctn |
| COLOR OPTION | ● ● ● ○ | ● ● ● ○ ● |
| MOUNTING | Screws | Screws |

Rechargeable Personal Safety Strobe



VIDEO



https://youtu.be/hVq_QujutWQ

| MODEL: | EL5103 |
|----------------|--------------------|
| SIZE | 90X80X22mm |
| LED | 27 LEDs |
| WORKING HOURS | 20 Hours |
| VIEWING ANGLE | 360°+ face |
| SYNC | synchronization |
| FLASH PATTERNS | 16 Patterns |
| MATERIAL | Aluminum + PC Lens |
| WATERPROOF | IP67, IP69K |
| MOUNT | Magnetic base |
| COLOR OPTION | ● ● ● ● ○ |
| WEIGHT | 8.5kg/ctn |
| PACKAGE | 40pcs/ctn |

RECHARGEABLE BEACON WITH ALARM

With backup alarm can work together or separately
 Work for 8 hours, 104Db alarm
 Magnet mount, rechargeable battery



RECHARGEABLE BEACON WITH SENSOR

Light sensor, automatically turn off during the day and
 Automatically turn on at night
 Work for 50 hours
 Replaceable and rechargeable battery



Replaceable and Rechargeable battery 12000mAh
 work for more than 50 hours



LIGHT SENSOR

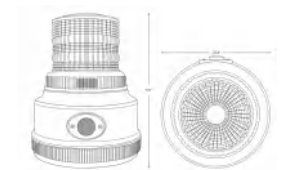

| PART NO. | EL529-1 |
|-------------------|--|
| POWER | 40pcs 1W LED |
| MOUNTING | Magnet Mount |
| BATTERY | Rechargeable battery |
| WORKING HOURS | 8 hours |
| ALARM | 104 dB alarm |
| FLASHING PATTERNS | 2 patterns (single Flash, Double flash) |
| SIZE | 110x110x80mm |
| PROTECTION | 10-30v, IP65 Waterproof |
| MATERIAL | PC Replaceable Lens, ABS base |
| WATERPROOF | 20pcs/ctn, 10.3kg, 68x27.5x20cm (70*30*22cm) |
| COLOR OPTION | ●●●●○ |

| PART NO. | EL5270 |
|-------------------|---|
| POWER | 22W (22pcs 1W LED) |
| BATTERY | Rechargeable battery |
| BATTERY CAPACITY | 12000mAh |
| WORKING HOURS | 50 hours |
| MOUNTING WAY | Magnet Mount |
| FLASHING PATTERNS | steady on, flash delay, steady flash or revolving |
| SIZE | 100x100x140mm |
| LENS | Replaceable Lens |
| WATERPROOF | IP65 |
| HOUSING | ABS Base, PC Lens |
| COLOR OPTION | ●●●○ |

BEACON 4 DIFFERENT SIZE



| PART NO. | EL5710-1 | EL5710-2 | EL5710-3 | EL5710-4 |
|-------------------|----------------------|--------------------|--------------------|--------------------|
| POWER | 20W (40pcs 0.5W LED) | 24W (24pcs 1W LED) | 48W (48pcs 1W LED) | 48W (48pcs 1W LED) |
| SIZE | 130x130x95mm | 135x135x110mm | 160x160x120mm | 160x160x150mm |
| APPROVED | ECE R65 R10, SAE | ECE R65 R10, SAE | ECE R65 R10, SAE | ECE R65 R10, SAE |
| FLASHING PATTERNS | 8 Patterns | 8 Patterns | 8 Patterns | 8 Patterns |
| VOLTAGE | 10-30V | 10-30V | 10-30V | 10-30V |
| WATERPROOF | IP67 | IP67 | IP67 | IP67 |
| HOUSING | ABS Base PC Lens | ABS Base PC Lens | ABS Base PC Lens | ABS Base PC Lens |
| WORKING TEMP | -40~85°C | -40~85°C | -40~85°C | -40~85°C |
| COLOR OPTION | ● ● ● ● ○ | ● ● ● ● ○ | ● ● ● ● ○ | ● ● ● ● ○ |
| MOUNT | Bolts Magnets | Bolts Magnets | Bolts Magnets | Bolts Magnets |

BEACON 3 MOUNTING WAYS



Model: EL521-1

Model: EL521-2

Model: EL521-3

| PART NO. | EL521-1 | EL521-2 | EL521-3 |
|-------------------|------------------|------------------|------------------|
| POWER | 30pcs LED | 30pcs LED | 30pcs LED |
| APPROVED | ECE R65 R10, SAE | ECE R65 R10, SAE | ECE R65 R10, SAE |
| FLASHING PATTERNS | 10 Patterns | 10 Patterns | 10 Patterns |
| SIZE | 145x145x116mm | 145x145x116mm | 128x128x213mm |
| VOLTAGE | 10-30V | 10-30V | 10-30V |
| MATERIAL | PC | PC | PC |
| WATERPROOF | IP67 | IP67 | IP67 |
| COLOR OPTION | ● ● ● ● ○ | ● ● ● ● ○ | ● ● ● ● ○ |
| MOUNT | Bolts Mount | Magnet Mount | DIN MOUNT |

Strobe Lights ECE TA2 TB2

R65 R10 SAE CISPR 25 C4

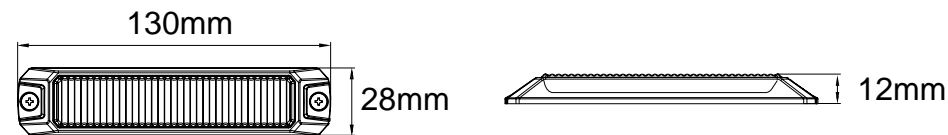

| MODEL | EL57 |
|---------------|----------------------------|
| SIZE | 130X28X12mm |
| POWER | 12W |
| CERTIFICATES | ECE R65 TA2, TB2, R10, SAE |
| FLASH PATTERN | 13 Patterns |
| SYNC | with SYNC & ASYNC function |
| WATERPROOF | IP67 |
| VOLTAGE | 10-30V |
| MATERIAL | Die-cast housing, PC Lens |
| WARRANTY | 3 Years |
| PACKAGE | 50pcs/ctn |
| COLOR OPTION | ● ● ● ○ |
| MOUNTING | Screws |

Wiring Instruciton

| | | |
|------------------------|--------|---|
| Positive VDC | Red | (12V DC or 24V DC only) |
| Negative Ground | Black | |
| Flash Pattern and SYNC | Yellow | (Momentarily touch for next pattern, touch for 5 second go back to first pattern) |
| Asynchronous | Green | |
| Cruise Light | White | (30% Brightness) |

* Connect the Yellow wire to positive will be Cruise Light as well

Synchronized Flash Setting

1. Connect all the Yellow wires together, and touch the Yellow wires to the positive for 5 seconds, and then all the lights will go back to the first flash pattern and will flash in SYNC.
2. Momentarily touch the Yellow wires to the positive for next pattern.

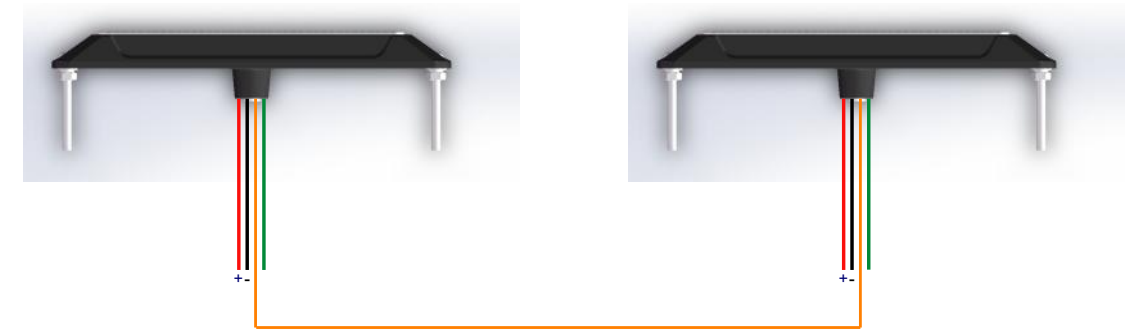

Asynchronous Flash Setting

1. Connect all the Yellow wires together, and touch the Yellow wires to the positive for 5 seconds, and then all the lights will go back to the first flash pattern and will flash in SYNC.
2. Momentarily touch the Yellow wires to the positive for next pattern.
3. Connect all the Green wires of all the lights you want to be asynchronous to the positive +, and the lights will flash asynchronously.

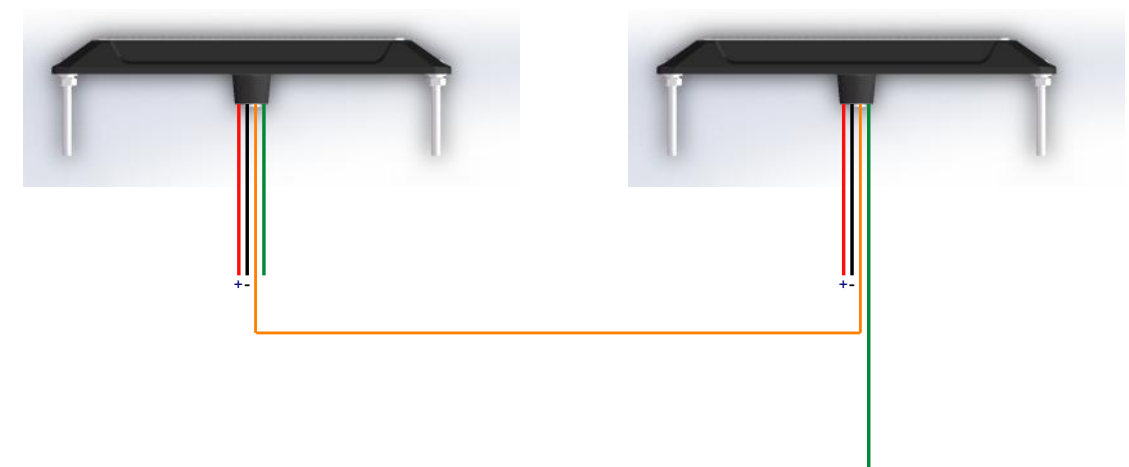

connect to the +, then this light will flash asynchronously

LED MINI BAR MAGNET MOUNTING



| | |
|----------------|----------------------|
| MODEL: | EL502 |
| SIZE | 10.8" |
| POWER | 48W |
| APPROVED | CE, ECE R10, EMC EMI |
| WATERPROOF | IP67 |
| MATERIAL | ABS/PC |
| FLASH PATTERNS | 10 patterns |
| PACKAGE | 10pcs/ctn |
| COLOR OPTIONS | ● ● ● ● ○ |
| MOUNT | Magnet mount |



| | |
|----------------|--------------------------|
| MODEL: | EL503 |
| SIZE | 10.8" |
| POWER | 48W |
| APPROVED | CE, ECE R65 R10, EMC EMI |
| WATERPROOF | IP67 |
| MATERIAL | ABS/PC |
| FLASH PATTERNS | 10 patterns |
| PACKAGE | 10pcs/ctn |
| COLOR OPTION | ● ● ● ● ○ |
| MOUNT | Magnet mount |



| | |
|----------------|----------------------|
| MODEL: | EL503 |
| SIZE | 10.8" |
| POWER | 48W |
| APPROVED | CE, ECE R10, EMC EMI |
| WATERPROOF | IP67 |
| MATERIAL | ABS/PC |
| FLASH PATTERNS | 10 patterns |
| PACKAGE | 10pcs/ctn |
| WEIGHT | ● ● ● ● ○ |
| MOUNT | Magnet mount |

Forklift Beacon 24W Osram

Super Bright



| | |
|------------|----------------------------------|
| PART NO. | EL5723 |
| DIMENSION | 4"x2.8"x5" |
| POWER | 24W |
| LED CHIP | 24pcs 1W Osram |
| APPROVED | ECE R65, R10, CE |
| WARRANTY | 3 Years |
| VOLTAGE | 10-110V |
| LED COLOR | ● ● ● ● ○ |
| WATERPROOF | IP67, IP69K |
| Mount | Screw Mount |
| HOUSING | PC Lens |
| Package | 20pcs/ctn, 6.1kg, 43.5x33x23.5cm |

LED Whip Lights, 360° RGB With Turn Signal, Brake, Reversing Function

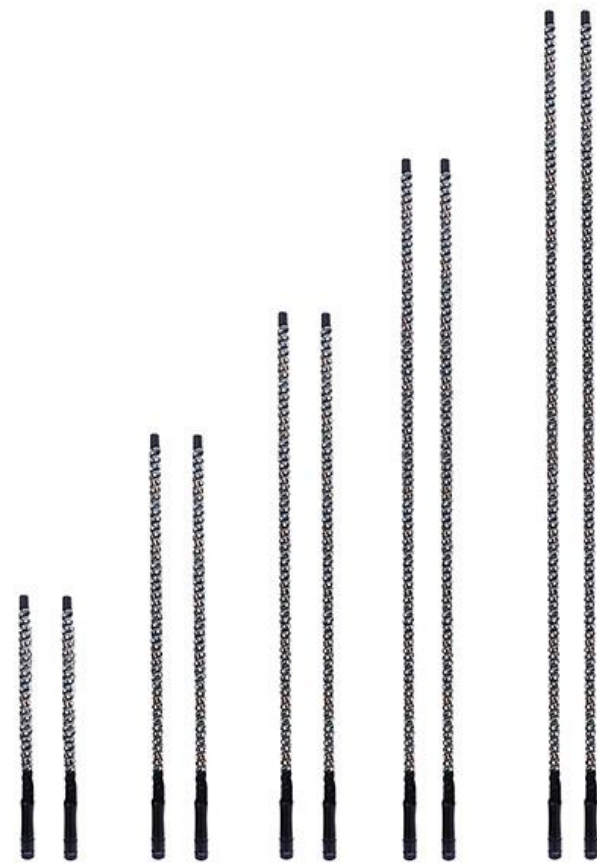

VIDEO



<https://youtu.be/wWvqbhxLLIk>

| MODEL | Q1-2FT | Q1-3FT | Q1-4FT | Q1-5FT | Q1-6FT |
|------------------|-------------------------------|--------------------|-------------------|-------------------|-------------------|
| LED | Super bright 5050LED | | | | |
| Color Option | RGB | | | | |
| Other function | Brake, Turn signal, Reversing | | | | |
| Voltage | 12V-24V | | | | |
| Housing material | Aluminun Alloy base | | | | |
| Mounting | Screws | | | | |
| Waterproof | IP66 | | | | |
| Length in ft | 2 ft | 3 ft | 4 ft | 5 ft | 6 ft |
| Length in cm | 61cm | 91cm | 122cm | 152cm | 183cm |
| Carton Size | 67x38x20cm | 100x38x20cm | 118.5x31x20cm | 155x31x20cm | 185x24x20cm |
| Carton Weight | 10set/ctn, 13.8kg | 10 set/ctn, 16.8kg | 8 set/ctn, 15.2kg | 8 set/ctn, 19.6kg | 6 set/ctn, 16.2kg |

- Over 300 Eye-Catching Patterns are sure to grab the attention of anyone passing by. With 32 brightness levels and 10 flash speed options.
- Remote Controlled with Speed, Color Mode, intensity & Strobing Function.
- Can be used as signal lights, brake lights, warning lights and chasing lights with brake, turning and reversing Function.
- Exclusive powerful spring design on the connector, Effective shock absorb, reduce the impact of sudden and strong shock in hard road conditions, cgreatly extend the product's life compair to other items in the market.
- Plug in installation, easy and more stable compair to other items in the market those only use the quick base. It's very necessary while in hard road condition.
- 360° of awesome color by flexible 360° wrapped tube.

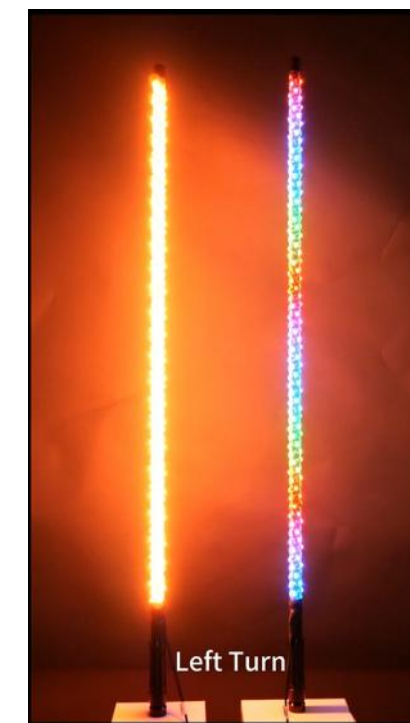
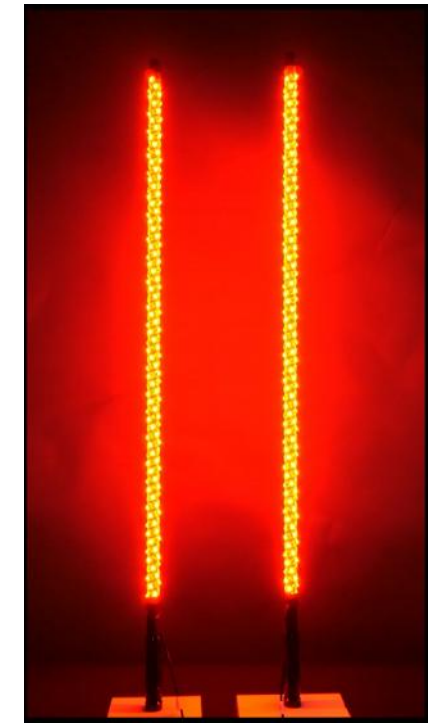
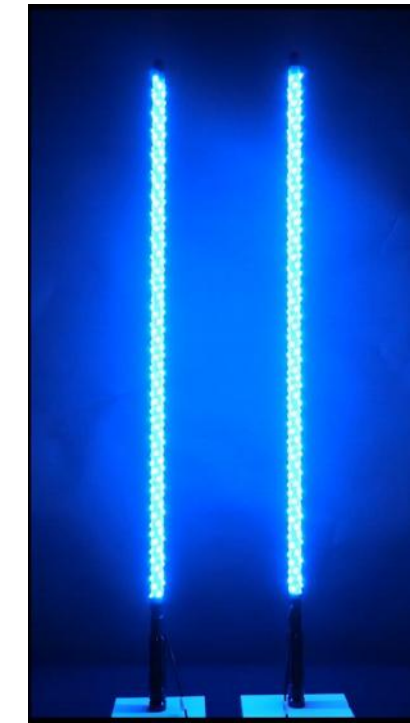

Safety Whip With Warning Light



→ 4 sides, 360° Flash

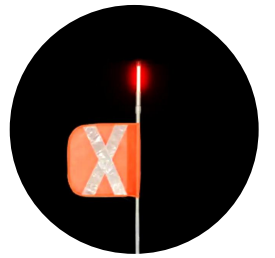

→ Reflective Flag

→ High Strength Glass Composite Fibre



→ Shock Resistance Carbon Steel Spring Base

→ Copper Connector

| MODEL | Q2-4FT | Q2-6FT | Q2-8FT | Q2-10FT |
|--------------------|-----------------------|-----------------------|-----------------------|-----------------------|
| Size (ft) | 4ft | 6ft | 8ft | 10ft |
| Size (cm) | 1.2m | 1.8m | 2.4m | 3m |
| LED | 12pcs 2835 RED LED | 12pcs 2835 RED LED | 12pcs 2835 RED LED | 12pcs 2835 RED LED |
| Pattern | Triple Flashing | Triple Flashing | Triple Flashing | Triple Flashing |
| illumination angle | 4 sides, 360° | 4 sides, 360° | 4 sides, 360° | 4 sides, 360° |
| Voltage | 12V-24V | 12V-24V | 12V-24V | 12V-24V |
| Pole material | Glass composite fibre | Glass composite fibre | Glass composite fibre | Glass composite fibre |
| Base | Spring base | Spring base | Spring base | Spring base |
| Mounting | Screws | Screws | Screws | Screws |
| Approved | ECE R10, CE, SAE | ECE R10, CE, SAE | ECE R10, CE, SAE | ECE R10, CE, SAE |
| Waterproof | IP66 | IP66 | IP66 | IP66 |
| Package | Woven Bag | Woven Bag | Woven Bag | Woven Bag |

Safety Whip With Warning Light



Magnetic mounting kit Safety Whips.

No need to drill any holes.
Simply attaches your safety whip to your vehicle by magnetic force.

| MODEL | Q3-4FT | Q3-6FT | Q3-8FT | Q3-10FT |
|--------------------|----------------------|----------------------|----------------------|----------------------|
| Size (ft) | 4ft | 6ft | 8ft | 10ft |
| Size (cm) | 1.2m | 1.8m | 2.4m | 3m |
| LED | 5050 LED | 5050 LED | 5050 LED | 5050 LED |
| Pattern | Flash / Crusie | Flash / Crusie | Flash / Crusie | Flash / Crusie |
| illumination angle | 2 sides | 2 sides | 2 sides | 2 sides |
| Voltage | 12V | 12V | 12V | 12V |
| Pole material | PC | PC | PC | PC |
| Pole Color | Clear or smoky black | Clear or smoky black | Clear or smoky black | Clear or smoky black |
| Base | latch base | latch base | latch base | latch base |
| Mounting | Screws | Screws | Screws | Screws |
| Waterproof | IP66 | IP66 | IP66 | IP66 |



WLB053
3pcs Strong Magnet
with suction cup
32x28x8cm
2cm thickness panel

Forklift Safety Light

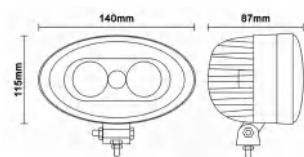

EL921

- 10W CREE
- 10-80V Working Voltage
- ECE R10 Approved
- IP67 Waterproof
- Blue or Red Spot beam
- Aluminum heat sink housing
- Polycarbonate lens
- 3 Years Warranty
- Operation temperature -40°C~60°C
- 18pcs/ctn, 14kg, 41x36.5x32cm

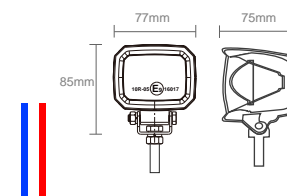

EL912

- 10W Osram
- 10-80V Working Voltage
- ECE R10 Approved
- IP67 Waterproof
- Blue or Red Straight Warning Line
- Aluminum heat sink housing
- Polycarbonate lens
- 3 Years Warranty
- Operation temperature -40°C~60°C
- 40pcs/ctn, 15.8kg, 45x37x23.5cm

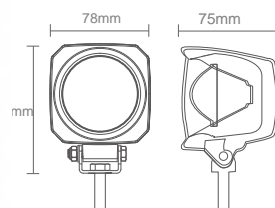

EL913

- 12W Osram
- 10-80V Working Voltage
- ECE R10 Approved
- IP67 Waterproof
- Blue or Red Spot beam
- Aluminum heat sink housing
- Polycarbonate lens
- 3 Years Warranty
- Operation temperature -40°C~60°C
- 40pcs/ctn, 13.6kg, 45x37x23.5cm

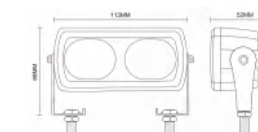

EL922

- 30W Osram
- 10-80V Working Voltage
- ECE R10 Approved
- IP67 Waterproof
- Blue or Red Straight Warning Line
- Aluminum heat sink housing
- Polycarbonate lens
- 3 Years Warranty
- Operation temperature -40°C~60°C

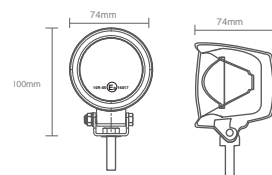

EL911

- 10W Osram
- 10-80V Working Voltage
- ECE R10 Approved
- IP67 Waterproof
- Blue or Red Arrow
- Aluminum heat sink housing
- Polycarbonate lens
- 3 Years Warranty
- Operation temperature -40°C~60°C



Forklift Safety Light



EL916

- 20W Osram
- 10-80V Working Voltage
- ECE R10 Approved
- IP67 Waterproof
- Blue or Red Semicircle Warning Line
- Aluminum heat sink housing
- Polycarbonate lens
- 3 Years Warranty
- Operation temperature -40°C~60°C

Forklift Safety Light

Dynamic flow



EL923

- 10W Osram
- 10-80V Working Voltage
- ECE R10 Approved
- IP67 Waterproof
- Blue or Red Dynamic Flow Beam
- Aluminum heat sink housing
- Polycarbonate lens
- 3 Years Warranty
- Operation temperature -40°C~60°C



45W High Power for Heavy Duty



EL924

- 45W Cree
- 10-80V Working Voltage
- ECE R10 Approved
- IP67 Waterproof
- Blue or Red Spot beam
- Aluminum heat sink housing
- Polycarbonate lens
- 3 Years Warranty
- Operation temperature -40°C~60°C

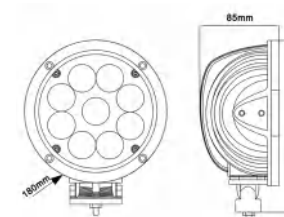



Model: EL301

- Backup Alarm
- Voltage: 12-80V
- Size: 104(L)x41(W)x66(H)mm
- Current: 0.1-0.8A
- Power: 15W
- Sound level: 107dB±3dB
- Package: 50pcs/ctn
- Carton: 18kgs



Model: EL302

- Black Alarm with Light
- Size: 102(L)x43.5(W)x85.5(H)mm
- Voltage: 9-80V
- Current: 0.1-2A
- Power: 20W
- Sound level: 107dB±3dB
- Package: 50pcs/ctn
- Carton: 21kg



Model: EL303

- Black alarm
- Size: 100(L)x40(W)x70(H)mm
- Voltage: 9-80V
- Current: 0.1-0.6A
- Power: 15W
- Sound level: 107dB±3dB
- Package: 50pcs/ctn
- Carton: 16KG

BACKUP ALARM

GET ALL YOUR LIGHTS UNDER CONTROL!

QC 3.0 USB fast charge, Type C Fast charge
 Overload protector, automatically cut off power.
 Two-color indicator light.
 With a reset switch.



| MODEL: | CS-976A1 | CS-976A2 | CS-352B1 | CS-464A1 | CS-441A1 |
|-----------------------|---|---|--------------------|--|---|
| Function | 4 Control switches 4 independent safety switches | 8 Control switches 8 independent safety switches | 4 Control switches | 1 Cigarette Lighter Socket 1 QC 3.0 USB Fast charge 1 Type C joint 4 Control switches | 1 Cigarette Lighter Socket 1 QC 3.0 USB Fast charge 1 Voltage Indicator 1 Type C joint 4 Control switches |
| Max Power | 240W | 240W | 240W | 240W | 240W |
| Size | 15x9cm | 21x9cm | 13x10cm | 13x10cm | 21x9cm |
| Input Voltage | 12-24V | 12-24V | 12-24V | 12-24V | 12-24V |
| Approved | CE, FCC | CE, FCC | CE, FCC | CE, FCC | CE, FCC |
| Panel Material | nylon | nylon | nylon | nylon | Aluminum alloy |
| Accessories | Stickers | Stickers | Stickers | Stickers | Stickers |

GET ALL YOUR LIGHTS UNDER CONTROL!

QC 3.0 USB fast charge, Type C Fast charge
 Overload protector, automatically cut off power.
 Two-color indicator light.
 With a reset switch.



| MODEL: | CS-221 | CS-831 | CS-651 | CS-101 | CS-103 |
|-----------------------|---|---|---|--|--|
| Function | QC 3.0 USB Fast charge Voltage Indicator | QC 3.0 USB Fast charge Type C joint, Voltage Indicator Cigarette Lighter Socket 8 Switches | 8 Control switches 8 independent safety switches | 1 Cigarette Lighter Socket 1 Voltage Indicator 10 Control switches 10 independent safety switches | 1 horn switch 2 USB 1 Voltage Indicator 10 Control switches 10 independent safety switches |
| Max Power | 240W | 240W | 240W | 240W | 240W |
| Size | 10.5x4.3cm | 15x11cm | 18x10cm | 21.8x18cm | 24.7x17.5cm |
| Input Voltage | 12-24V | 12-24V | 12-24V | 12-24V | 12-24V |
| Approved | CE, FCC | CE, FCC | CE, FCC | CE, FCC | CE, FCC |
| Panel Material | nylon | nylon | Aluminum alloy | Aluminum alloy | Aluminum alloy |
| Accessories | Stickers | Stickers | Stickers | Stickers | Stickers |



LED Work Light



Model: EL205 (90W)



Model: EL260 (60W)



Model: EL262 (60W)



Model: EL270 (39W)



Model: E216 (18W)



Model: EL221 (18W)



Model: EL211 (20W)
20pcs/ctn, 7.95kg, (48x36x20cm)



Model: EL211-1 (18W)



Model: EL268 (10W)
20pcs/ctn, 5.3kg, (32x28x23cm)



Model: EL269 (20W)



Model: EL260 (30W)



Model: EL262 (45W)



Model: EL2113R



Model: EL2112



Model: EL225 (24W)

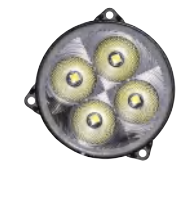

Model: EL2108 (40W)



Model: EL215 (36W)



Model: EL237 (24W)



Model: EL213 (30W)



Model: EL2021-12 (12W)



Model: EL2021-30 (30W)



Model: EL2022-24 (24W)



Model: EL2022-16 (16W)



Model: EL2022-12 (12W)

HENDO
LED TECHNOLOGIES

HENDO
LED TECHNOLOGIES



CONTACT INFORMATION:

4368 Corporate Dr, Burlington,
ONTARIO L7L 5R3, Canada
www.hendoled.com

Email: sales@hendoled.ca

**LED DRIVING LIGHTS
CATALOGUE**

Laser Eye 2"

Laser Beam
Glass lens
White beam or yellow beam

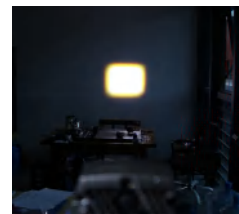
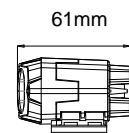
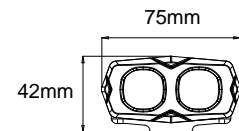

| PART NO. | EL406 |
|-----------------|--|
| Size | 2" [41x75x62mm] |
| Power | 40W [2pcs 20W, 2A@12V] |
| Raw Lumen | 3800LM |
| Effective Lumen | 2850LM, 1lux@350m |
| Beam Pattern | Laser Beam (White beam or yellow beam) |
| Certificates | IP68, CE |
| Voltage | 10-30V |
| Material | Aluminum housing, Glass lens |
| Warranty | 3 Years |
| Package | 20pcs/ctn, 15kg, 36x30x36cm |

LED Driving Light 3" & 4"

ATV & UTV Application
White beam or yellow beam



Model: EL413



Model: EL414



Model: EL415

| PART NO. | EL413 | EL414 | EL415 |
|-----------------|-------------------------------|------------------------------|------------------------------|
| Size | 4" [100x66x95mm] | 3" | 3" |
| Power | 50W [2.6A@12V=31.2W] | 40W [2.1A@12V=25.2W] | 30W [1.6A@12V=19.2W] |
| Raw Lumen | 3800LM | 3500LM | 2850LM |
| Effective Lumen | 2800LM, 1lux@210m | 2700LM | 2100LM |
| Beam Pattern | Flood or Spot | Flood or Spot | Flood or Spot |
| Certificates | IP68, CE, EMC | IP68, CE, EMC | IP68, CE, EMC |
| Voltage | 10-80V | 10-30V | 10-30V |
| Material | Aluminum housing, PC lens | Aluminum housing, PC lens | Aluminum housing, PC lens |
| Warranty | 3 Years | 3 Years | 3 Years |
| Package | 30pcs/ctn, 16.6kg, 60x28x26cm | 20pcs/ctn, 7.3kg, 58x23x23cm | 20pcs/ctn, 9.3kg, 58x23x23cm |



LED Driving Light 6" New!

184128 CD, 429 Meters @ 1Lux
4.6° High beam Driving Light
White beam or Yellow beam is available
With protective cover



| PART NO. | EL407 |
|-----------------|---|
| Size | 6" [175x175x90mm] |
| Power | 50W [2.75A@12V] |
| Raw Lumen | 4800LM [184128 CD] |
| Effective Lumen | 3200LM, 1lux@429m |
| Beam Pattern | 4.6° High beam (White or Amber) |
| Certificates | IP67, CE, EMARK, Rohs |
| Voltage | 10-30V |
| Material | Aluminum housing, PC lens (with protective cover) |
| Warranty | 3 Years |
| Package | 1 pair/ctn, 38x11x21cm, 3.3kg |

LED CUBE Lights

3.6" & 5"

ECE R112 R148

With Position Lights
40W & 75W OSRAM LED



LED Driving Lights

5", 7", 8.5"

ECE R112

DT Connector
with protective lens
OSRAM OSLO chip



| PART NO. | EL408-3.6" | EL408-5" |
|-----------------|--------------------------------|------------------------------------|
| Size | 3.6" [92x82x105mm] | 5" [124x84x143mm] |
| Power | 40W [8pcs 5W OSRAM, 2.1A@12V] | 75W [15pcs 5W OSRAM LED, 3.8A@12V] |
| Raw Lumen | 2500LM | 4500LM |
| Effective Lumen | 1800LM, 1lux@150m | 3200LM, 1lux@260m |
| Beam Pattern | Combo beam with position light | Combo beam with position light |
| Certificates | IP67, CE, ECE R112 R10, Rohs | IP67, CE, ECE R112 R10, Rohs |
| Voltage | 10-30V | 10-30V |
| Material | Aluminum housing, PC lens | Aluminum housing, PC lens |
| Warranty | 3 Years | 3 Years |
| Package | 10 Pairs/ctn | 10 Pairs/ctn |

| PART NO. | EL441-5 | EL441-7 | EL441-8.5 |
|-----------------|-------------------------|-----------------------|--------------------------|
| Size | 5" 50W Osram | 7" 90W Osram | 8.5" 160W Osram |
| LED | 5W oslon chip, 3.5A@12V | 5W oslon chip, 6A@12V | 5W oslon chip, 13.1A@12V |
| Raw Lumen | 7600LM | 12500LM | 19600LM |
| Effective Lumen | 5880LM | 9250LM | 10780LM |
| 1 Lux | 1lux@459m | 1lux@800m | 1lux@1050m |
| 10 meter | 2490Lux@10m | 6324Lux@10m | 12500Lux@10m |
| Certificates | CE, ECE R112 R10, FCC | CE, ECE R112 R10, FCC | CE, ECE R112 R10, FCC |
| Protection | IP69K, 10-30V | IP69K, 10-30V | IP69K, 10-30V |
| Material | Die-cast Alu, PC lens | Die-cast Alu, PC lens | Die-cast Alu, PC lens |
| Warranty | 3 Years | 3 Years | 3 Years |

LED Driving Lights 7" & 9"

DT Connector
with protective lens



| PART NO. | EL474 | EL495 |
|-----------------|-----------------------------|------------------------------|
| Size | 7" | 9" |
| Power | 96W [32pcs 3W, 6.5A@12V] | 160W [32pcs 5W, 10A@12V] |
| Raw Lumen | 9500LM | 14800LM |
| Effective Lumen | 7500LM | 10200LM |
| Beam Pattern | Spot or Combo | Spot or Combo |
| Certificates | IP68, CE, ECE R10, Rohs | IP68, CE, ECE R10, Rohs |
| Voltage | 10-30V | 10-30V |
| Material | Die-cast Alu, PC lens | Die-cast Alu, PC lens |
| Warranty | 3 Years | 3 Years |
| Package | 4pcs/ctn, 7.4kg, 42x28x28cm | 4pcs/ctn, 10.5kg, 54x32x34cm |

LED Driving Light 9"

DT Connector
with protective lens



| PART NO. | EL496 |
|-----------------|---|
| Size | 9" |
| Power | 120W [16pcs 5W + 1pc 40W LED, 8.7A@12V] |
| Raw Lumen | 10800LM |
| Effective Lumen | 9000LM |
| Beam Pattern | Combo Beam |
| Certificates | IP67, CE, ECE R10, Rohs |
| Voltage | 10-30V |
| Material | Die-cast Alu, PC lens |
| Warranty | 3 Years |
| Package | 4pcs/ctn, 11.6kg, 53x32x33cm |

Laser Driving Light 5.6" Round

Laser + Flood + Spot
120W

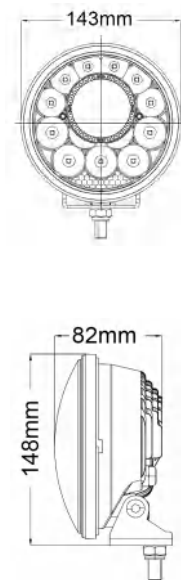

| PART NO. | EL431-5.6 |
|-----------------|---|
| Size | 5.6" [143x82x148mm] |
| Power | 120W [11pcs 10W OSRAM LED, 1 pc Laser Chip, 5.9A@12V] |
| Raw Lumen | 7000LM |
| Effective Lumen | 5500LM, 1lux@1100m |
| Beam Pattern | Laser + Flood + Spot |
| Certificates | IP67, CE, EMARK, Rohs |
| Voltage | 10-30V |
| Material | Aluminum housing, PC lens |
| Warranty | 3 Years |
| Package | 6 pcs/ctn, 15kg, 46x37x38cm |

Laser Driving Light 5" Square

Laser + Spot
65W

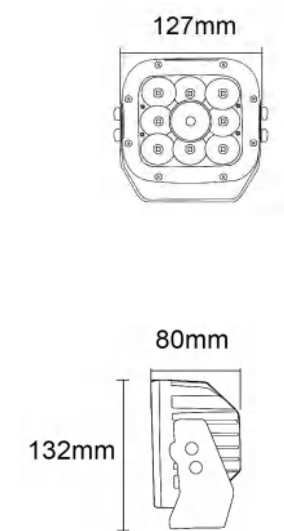

| PART NO. | EL498 |
|-----------------|---|
| Size | 5" [127x80x132mm] |
| Power | 65W [8pcs 5W OSRAM LED, 1 pc Laser Chip, 3.75A@12V] |
| Raw Lumen | 5800LM |
| Effective Lumen | 4800LM, 1lux@980m |
| Beam Pattern | Laser + Spot |
| Certificates | IP67, CE, EMARK, Rohs |
| Voltage | 10-30V |
| Material | Aluminum housing, PC lens |
| Warranty | 3 Years |
| Package | 12 pcs/ctn, 15.5kg, 47x38x40cm |

Laser Driving Light 7" New!

Laser + Flood + Spot
120W OSRAM
Protective cover is available

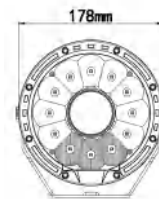

| PART NO. | EL430-7 |
|-----------------|--|
| Size | 7" [178X75X193mm] |
| Power | 120W [12pcs OSARM P8, 1 pc Laser chip, 7.1A@12V] |
| Raw Lumen | 8500LM |
| Effective Lumen | 6800LM, 1lux@1200m |
| Beam Pattern | Laser + Flood + Spot |
| Certificates | IP67, CE, EMARK, Rohs |
| Voltage | 10-30V |
| Material | Aluminum housing, PC lens |
| Warranty | 3 Years |
| Package | 8pcs/ctn, 14.5kg, 44X39X27cm |

Laser Driving Light 9" New!

Laser + Flood + Spot
150W OSRAM
Protective cover is available

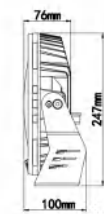
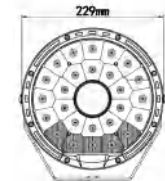

| PART NO. | EL430-9 |
|-----------------|---|
| Size | 9" [229x100x247mm] |
| Power | 150W [26pcs OSARM P8, 1 pc Laser chip, 10A@12V] |
| Raw Lumen | 14500LM |
| Effective Lumen | 10800LM, 1lux@1400m |
| Beam Pattern | Laser + Flood + Spot |
| Certificates | IP67, CE, EMARK, Rohs |
| Voltage | 10-30V |
| Material | Aluminum housing, PC lens |
| Warranty | 3 Years |
| Package | 6pcs/ctn, 16kg, 47x38x40cm |

Laser Driving Light 7" Round

OSRAM LED
OSRAM LASER
3 different protective lens options



Laser Driving Light 8.5" Round

OSRAM LED
OSRAM LASER
3 different protective lens options



| PART NO. | EL494-7 |
|-----------------|--|
| Size | 7" |
| Power | 65W [8pcs 5W OSRAM LED, 1pc Laser Chip, 4.75A@12V=57W] |
| Raw Lumen | 6000LM |
| Effective Lumen | 5500LM, 1lux@1250m |
| Beam Pattern | Laser + Spot |
| Certificates | IP67, CE, EMARK, FDA, Rohs |
| Voltage | 10-30V |
| Material | Die-cast Alu, PC lens |
| Warranty | 3 Years |
| Package | 13.2kg, 4pcs/ctn, 51.5x48x14.5cm |

| PART NO. | EL494-8.5 |
|-----------------|---|
| Size | 8.5" |
| Power | 145W [24pcs 5W OSRAM LED, 1pc Laser Chip, 11.3A@12V=135.6W] |
| Raw Lumen | 16600LM |
| Effective Lumen | 13500LM, 1lux@1500m |
| Beam Pattern | Laser + Spot + Combo |
| Certificates | IP67, CE, EMARK, FDA, Rohs |
| Voltage | 10-30V |
| Material | Die-cast Alu, PC lens |
| Warranty | 3 Years |
| Package | 8.2kg, 1 pair/ctn, 50.5x30.5x14.5cm |

Laser Driving Light 9" Round

OSRAM LED, OSRAM LASER
White Position
3 colors decorative frames
3 different protective lens options



PART NO. EL494-9

| | |
|-----------------|---|
| Size | 9" |
| Power | 145W [24pcs 5W OSRAM LED, 1pc Laser Chip, 12A@12V=144W] |
| Raw Lumen | 16600LM |
| Effective Lumen | 13500LM, 1lux@1500m |
| Beam Pattern | Laser + Flood + Spot with position light |
| Certificates | IP67, CE, EMARK, FDA, Rohs |
| Voltage | 10-30V |
| Material | Die-cast Alu, PC lens |
| Warranty | 3 Years |
| Package | 9.1kg, 1 pair/ctn, 50.5x30.5x16cm |

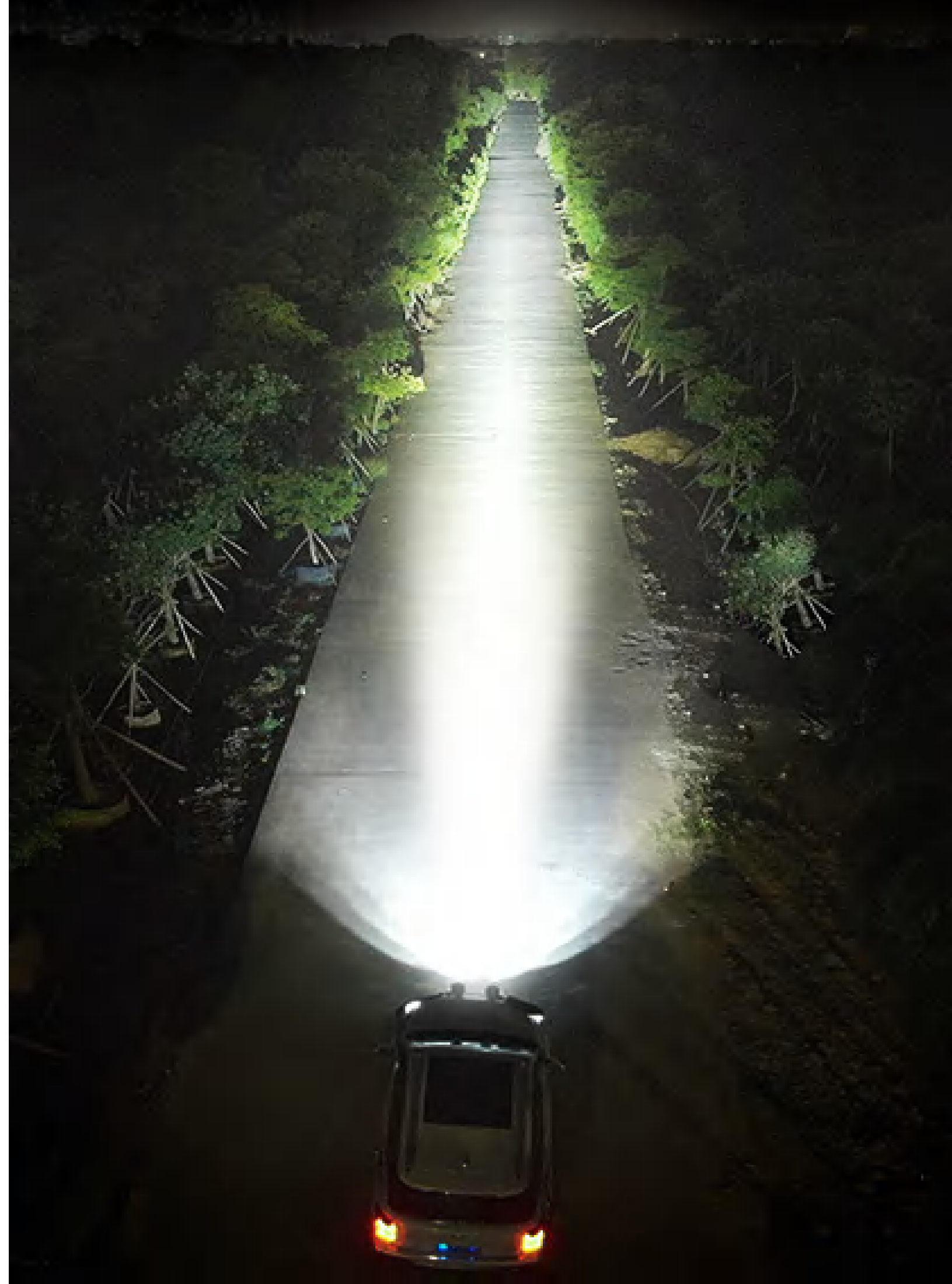

Laser Light Bar

12", 20", 30", 40", 50"
New!

5W OSRAM LED with OSRAM Laser
Side bracket mount or middle
bracket mount
Black or White housing

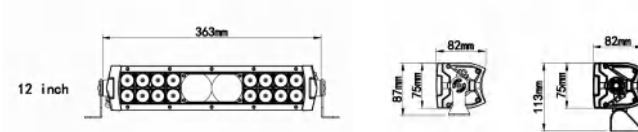

| PART NO. | EL633-12" | EL633-20" | EL633-30" | EL633-40" | EL633-50" |
|--------------|-----------------------|-----------------------|-----------------------|-----------------------|-----------------------|
| Size | 12" | 20" | 30" | 40" | 50" |
| Power | 130W | 210W | 315W | 420W | 525W |
| Raw Lumen | 11700LM | 18900LM | 28350LM | 37800LM | 47250LM |
| Beam Pattern | Laser + Spot | Laser + Spot | Laser + Spot | Laser + Spot | Laser + Spot |
| Certificates | IP67, CE, EMARK | IP67, CE, EMARK, | IP67, CE, EMARK | IP67, CE, EMARK | IP67, CE, EMARK |
| Voltage | 10-30V | 10-30V | 10-30V | 10-30V | 10-30V |
| Material | Die-cast Alu, PC Lens | Die-cast Alu, PC Lens | Die-cast Alu, PC Lens | Die-cast Alu, PC Lens | Die-cast Alu, PC Lens |
| Warranty | 3 Years | 3 Years | 3 Years | 3 Years | 3 Years |
| Package | 8pcs/ctn, 19.7kg | 6pcs/ctn, 18kg | 6pcs/ctn, 25kg | 4pcs/ctn, 21kg | 4pcs/ctn, 25kg |
| Carton | 48x38x39cm | 68x38x26cm | 94x38x26cm | 119x26x26cm | 140x30x26cm |



LED Light Bar 6W OSRAM Chip ECE R112 R10

Ultra-light weight design
No screws on the front frame
Side brakcet or Middle bracket

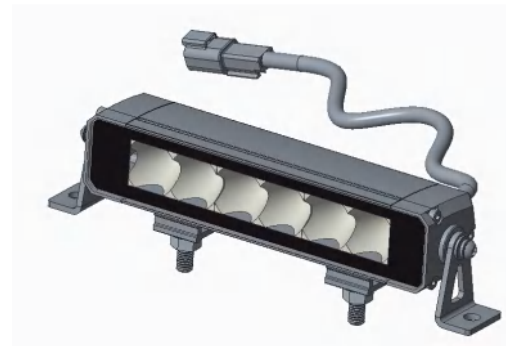

LED Light Bar 6W OSRAM Chip ECE R112 R10

Ultra-light weight design
No screws on the front frame
Side brakcet or Middle bracket



| PART NO. | EL634-8" | EL634-14" | EL634-22" | EL634-32" | EL634-42" | EL634-52" |
|--------------|---|-----------|-----------|-----------|-----------|------------|
| Size (inch) | 8" | 14" | 22" | 32" | 42" | 52' |
| Size (cm) | 20cm | 36cm | 56cm | 82cm | 110cm | 133cm |
| Power | 36W | 72W | 120W | 180W | 240W | 300W |
| LED | 6pcs LED | 12pcs LED | 20pcs LED | 30pcs LED | 40pcs LED | 50pcs LED' |
| Chip | 6W Osram Chip | | | | | |
| Beam Pattern | Driving Beam | | | | | |
| Mounting | Side bracket + Middle bracket | | | | | |
| Material | aluminum housing, PC lens, DT connector | | | | | |
| Voltage | 10-30V, IP68 waterproof | | | | | |
| Certificates | CE, ECE R10 R112, SAE, UKCA | | | | | |
| Warranty | 3 Years Warranty | | | | | |

| PART NO. | EL635-8" | EL635-14" | EL635-22" | EL635-32" | EL635-42" | EL635-52" |
|--------------|---|-----------|-----------|-----------|-----------|------------|
| Size (inch) | 8" | 14" | 22" | 32" | 42" | 52' |
| Size (cm) | 20cm | 36cm | 56cm | 82cm | 110cm | 133cm |
| Power | 36W | 72W | 120W | 180W | 240W | 300W |
| LED | 6pcs LED | 12pcs LED | 20pcs LED | 30pcs LED | 40pcs LED | 50pcs LED' |
| Chip | 6W Osram Chip | | | | | |
| Beam Pattern | Driving Beam | | | | | |
| Mounting | Side bracket + Middle bracket | | | | | |
| Material | aluminum housing, PC lens, DT connector | | | | | |
| Voltage | 10-30V, IP68 waterproof | | | | | |
| Certificates | CE, ECE R10 R112, SAE, UKCA | | | | | |
| Warranty | 3 Years Warranty | | | | | |

LED Light Bar Double Row



- 10-30V, IP67 Waterproof
- Spot or Flood or combo beam is available
- 1 Year warranty
- Die-cast housing, PC lens
- Stainless steel
- CE Approved

| MODEL | POWER | SIZE | LED | L / width / thickness | Package |
|------------|-------|------|--------|-----------------------|-----------|
| EL602-36W | 36W | 8" | 12pcs | 205x77x87mm | 20pcs/ctn |
| EL602-72W | 72W | 14" | 24pcs | 360x77x87mm | 10pcs/ctn |
| EL602-120W | 120W | 22" | 40pcs | 560x77x87mm | 6pcs/ctn |
| EL602-180W | 180W | 32" | 60pcs | 825x77x87mm | 6pcs/ctn |
| EL602-240W | 240W | 43" | 80pcs | 1085x77x87mm | 4pcs/ctn |
| EL602-300W | 300W | 53" | 100pcs | 1335x77x87mm | 4pcs/ctn |

LED Light Bar Double Row



EL604-72W, 24LED



EL604-126W, 42LED



EL604-180W, 60LED

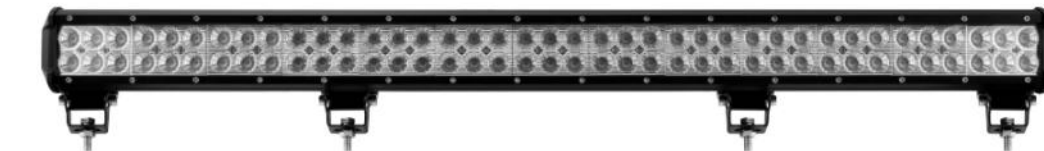

EL604-234W, 78LED

- 10-30V, IP67 Waterproof
- Spot or Flood or combo beam is available
- 1 Year warranty
- Die-cast housing, PC lens
- Stainless steel
- CE, ECE Approved

| MODEL | POWER | SIZE | LED | L / width / thickness | Package |
|------------|-------|------|-------|-----------------------|---------|
| EL604-18W | 18W | 3.5" | 6pcs | 96x78x61mm | 30 |
| EL604-36W | 36W | 6" | 12pcs | 166x78x61mm | 20 |
| EL604-54W | 54W | 9" | 18pcs | 235x78x61mm | 20 |
| EL604-72W | 72W | 12" | 24pcs | 305x78x61mm | 10 |
| EL604-90W | 90W | 15" | 30pcs | 373x78x61mm | 10 |
| EL604-108W | 108W | 17" | 36pcs | 470x78x61mm | 10 |
| EL604-126W | 126W | 20" | 42pcs | 508x78x61mm | 10 |
| EL604-144W | 144W | 22" | 48pcs | 570x78x61mm | 6 |
| EL604-180W | 180W | 28" | 60pcs | 712x78x61mm | 8 |
| EL604-234W | 234W | 36" | 78pcs | 916x78x61mm | 4 |

Magnet Base



D44
44mm magnet
pull strength: 8.5kg



D66
66mm magnet
pull strength: 16kg



D88
88mm magnet
pull strength: 30kg

Vacuum Suction Cup

Application:

Glass surface / Plastic surface / Aluminum alloy roof / Carbon fiber roof / Car or boat surface



SC-3"
3" Vacuum Suction Cup
71mm Diameter base
pull strength: 162kg



SC-4.5"
4.5" Vacuum Suction Cup
117mm Diameter base
pull strength: 324kg

Beacon Din Mount Bracket



DMB1



DMB2



DMB3



DMB4



DMB5



DMB6



DMB7



DMB8



DMB9

WIRING HARNESS

Different Length
Different Control way
Different Connector

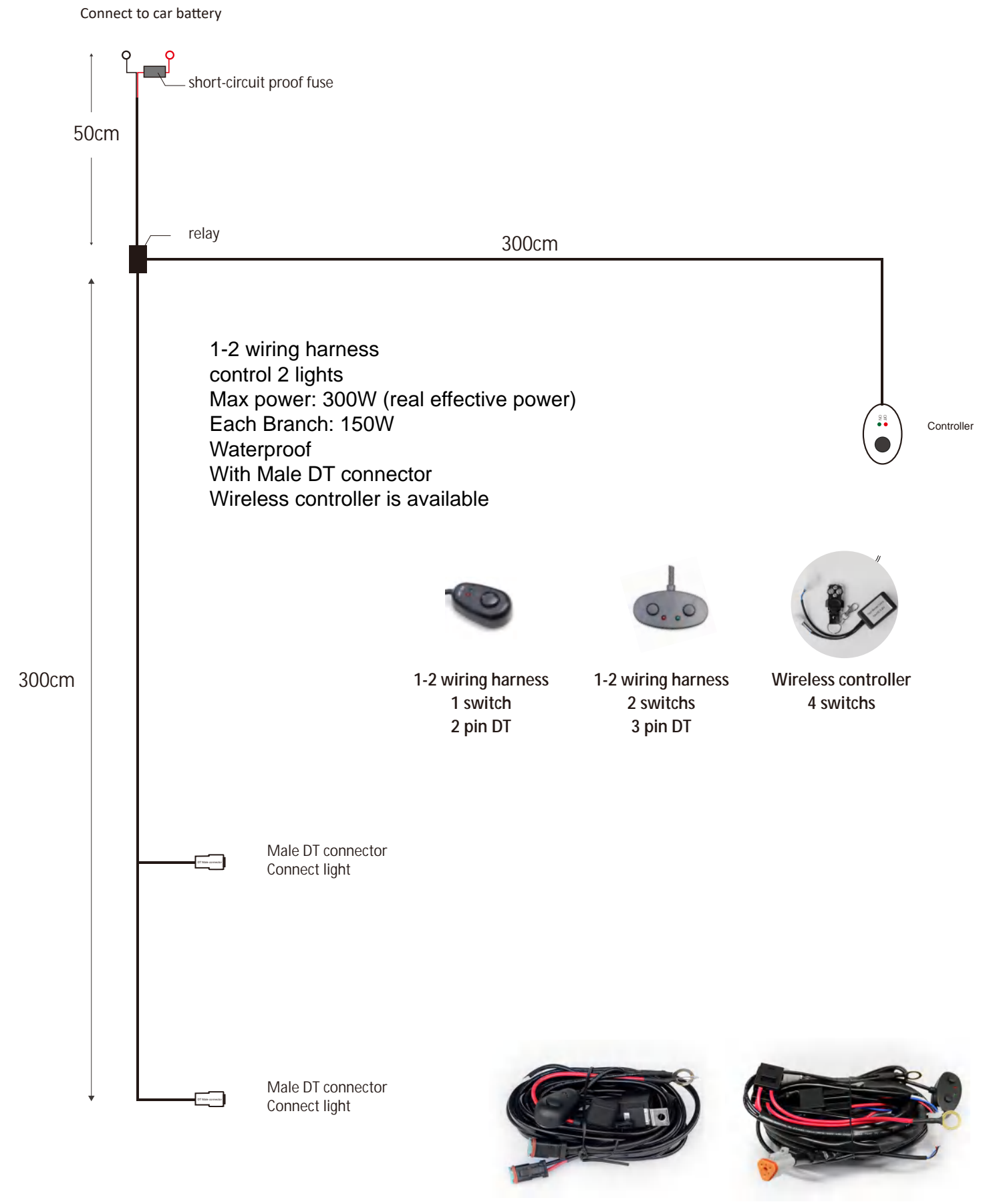
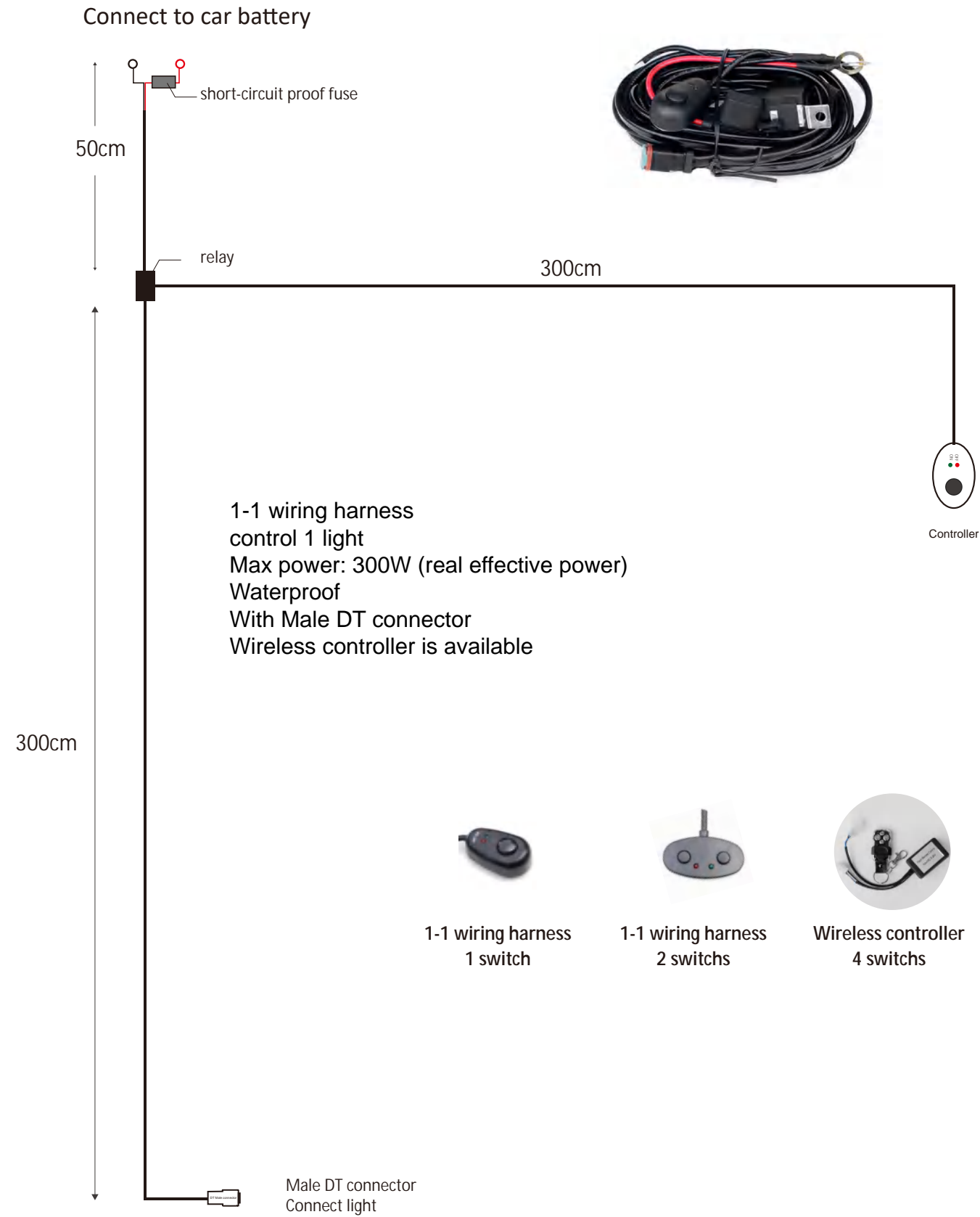

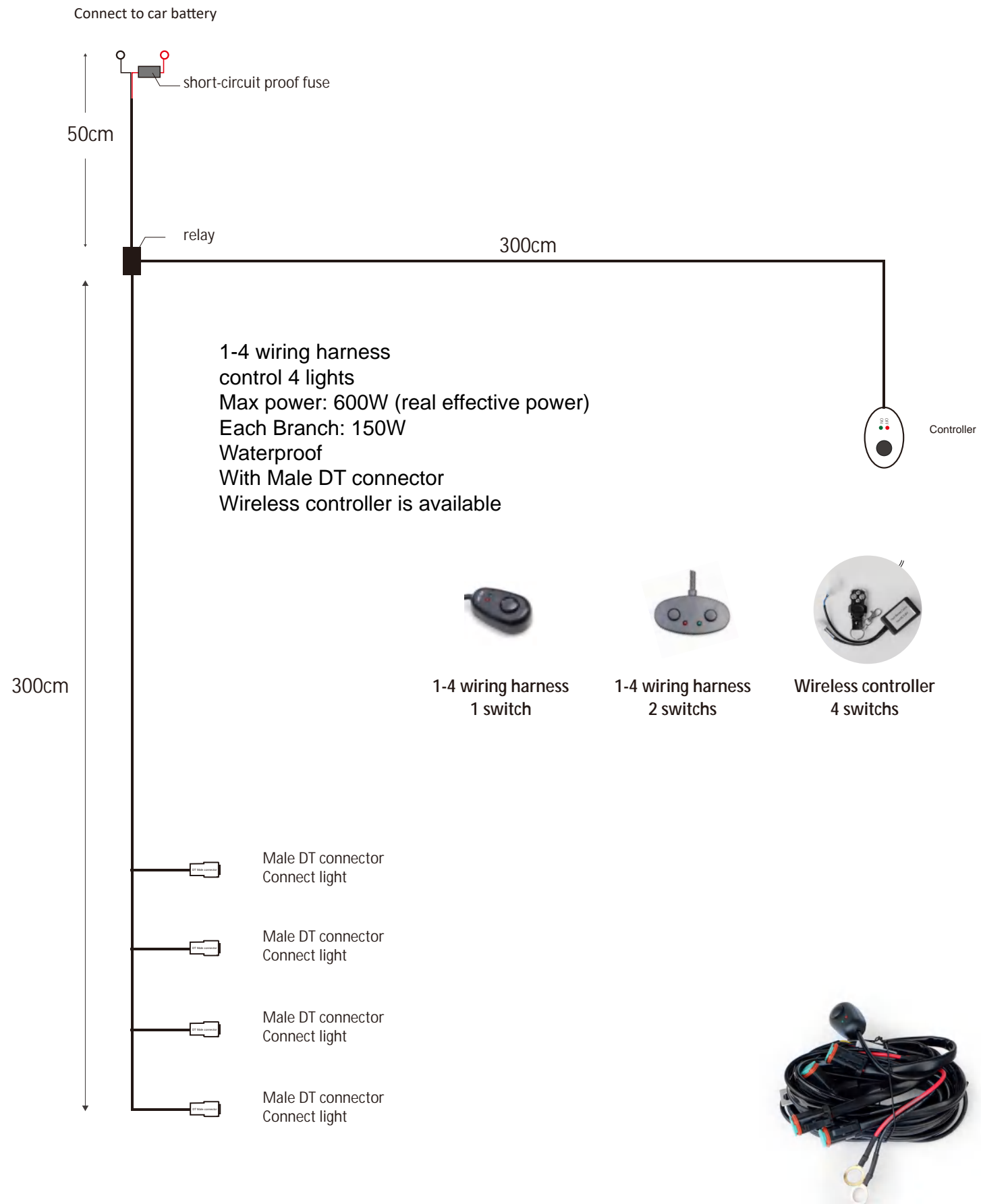

Connectors:



Controller:



Bracket

for Work light, Whip Light, Driving Light



WLB051
For 1.5"-2" pipe
360° rotating



Bracket

for Work light, Whip Light, Driving Light



WLB052
360° rotating



Magnet Bracket

180° Rotating



ELE-048
2pcs 88mm magnets
pull strength: 60kg
180° rotating



Magnet Bracket



ELE-0105
2pcs 88mm magnets
pull strength: 60kg



ELE-0106
2pcs 88mm magnets
pull strength: 60kg

HENDO
LED TECHNOLOGIES

HENDO
LED TECHNOLOGIES



LED SINGAL LIGHTS

LED Wireless Tail Light

5000mAh battery Each Side

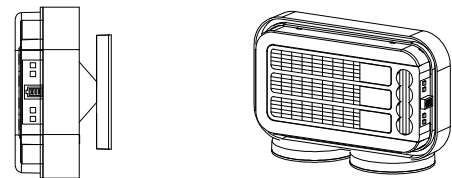

Horizontal magnetic mounting Vertical magnetic mounting

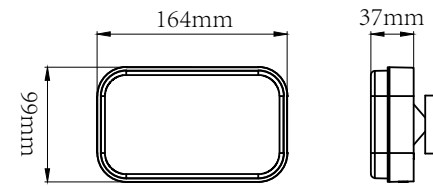

- Adopt new power-off technology. Even if the light is put away for a long time, the battery capacity can still maintain more than 95%.
- The lights have an auto-off function, and the standby time is 2 hours. If there is no operation within 2 hours, the lights will automatically turn off. It can prevent the driver from forgetting to turn off the light and causing the battery to run out.
- Each light can choose to install magnets horizontally or vertically.
- The adapter can be selected with or without CANBUS CONTROLLER

With Canbus controller: 12V only

Without Canbus controller: 12-24V available

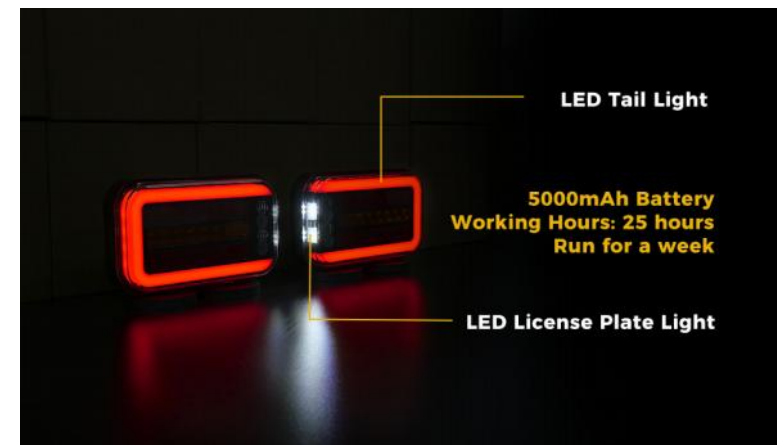

| MODEL | T1 |
|-------------------|--|
| Size | 165X100X39.5mm |
| Function | Tail Light / Brake light / Indicator / Reversing light / License plate light |
| Charging hours | 6 Hours |
| Standby | 2 Hours |
| Battery Capacity | 5000mAh |
| Frequency | 2.4G |
| Approval | ECE, FCC, CE, UKCA |
| Housing material | PC |
| Mounting | horizontal and vertical |
| Connector | 7 pin / 6 Blade / 4 Pin |
| Voltage | 12V or 24V |
| Canbus Controller | Available |
| Waterproof | IP66 |
| Warranty | 2 year |

15.7" LED TRAILER LIGHT



| PART NO. | EL7701-DI | EL7701-R | EL7701-ST | EL7701-STD |
|----------------|--------------------|-----------------|----------------------|---------------------------|
| Size | 40x2x4cm | 40x2x4cm | 40x2x4cm | 40x2x4cm |
| Function | Director Indicator | Reversing | Rear position, Brake | DI & Rear position, Brake |
| Voltage | 12V - 24V | 12V - 24V | 12V - 24V | 12V - 24V |
| Waterproof | IP67 | IP67 | IP67 | IP67 |
| Lens Material | ABS | ABS | ABS | ABS |
| Cover Material | Chrome Housing | Chrome Housing | Chrome Housing | Chrome Housing |
| Approved | DOT | DOT | DOT | DOT |
| Warranty | 3 Years | 3 Years | 3 Years | 3 Years |
| Connection | 3 wires pigtail | 3 wires pigtail | 3 wires pigtail | 3 wires pigtail |
| Package | 50pcs/ctn | 50pcs/ctn | 50pcs/ctn | 50pcs/ctn |

3/4" Round LED Marker / Clearance Lights



MODEL: EL7341

| MODEL: | EL7341 |
|-----------------|-------------------------------|
| Size | 3/4" Round |
| Diodes | 1pcs |
| Available color | Red, Amber, White |
| Voltage | 12V or 24V |
| Waterproof | IP67 |
| Material | ABS/AS |
| Warranty | 1 Years |
| Mounting | Grommet |
| Wires | 2 wires pigtail |
| Package | 200pcs/ctn, 12kgs, 51X24X30cm |

4" PVC Rubber Round Truck Light



MODEL: EL794



MODEL: EL795

| PART NO. | EL794 | EL795 |
|------------------|--------------------------------|--------------------------------|
| Size | 4" round | 4" round |
| Available color | Red, Amber, White | Red, Amber, White |
| Voltage | 12V or 24V | 12V or 24V |
| Waterproof | IP67 | IP67 |
| Lens Material | ABS/AS | ABS/AS |
| Cover Material | ABS/AS | ABS/AS |
| Grommet material | PVC | PVC |
| Warranty | 1 Years | 1 Years |
| Kit includes: | Grommet, 3 wires pigtail | Grommet, 3 wires pigtail |
| Package | 50pcs/ctn, 14.5kgs, 71x31x34cm | 50pcs/ctn, 14.5kgs, 71x31x34cm |

4" PVC Rubber Round Truck Light



MODEL: EL796



MODEL: EL797

| PART NO. | EL796 | EL797 |
|------------------|--------------------------------|--------------------------------|
| Size | 4" round | 4" round |
| Function | Red, Amber, White | Red, Amber, White |
| Voltage | 12V or 24V | 12V or 24V |
| Waterproof | IP67 | IP67 |
| Lens Material | ABS/AS | ABS/AS |
| Cover Material | ABS/AS | ABS/AS |
| Grommet material | PVC | PVC |
| Warranty | 1 Years | 1 Years |
| Kit includes: | Grommet, 3 wires pigtail | Grommet, 3 wires pigtail |
| Package | 50pcs/ctn, 14.5kgs, 71x31x34cm | 50pcs/ctn, 14.5kgs, 71x31x34cm |

6" PVC Rubber Round Truck Light



MODEL: EL781



MODEL: EL782

| PART NO. | EL781 | EL782 |
|------------------|------------------------------------|------------------------------------|
| Size | 6" Oval | 6" Oval |
| Available color | Red, Amber, White | Red, Amber, White |
| Voltage | 12V or 24V | 12V or 24V |
| Waterproof | IP67 | IP67 |
| Lens Material | ABS/AS | ABS/AS |
| Cover Material | ABS/AS | ABS/AS |
| Grommet material | PVC | PVC |
| Warranty | 1 Years | 1 Years |
| Kit includes: | Grommet, 3 wires pigtail | Grommet, 3 wires pigtail |
| Package | 50pcs/ctn, 14.5kgs, 47.5x42x27.5cm | 50pcs/ctn, 14.5kgs, 47.5x42x27.5cm |

6" PVC Rubber Round Truck Light

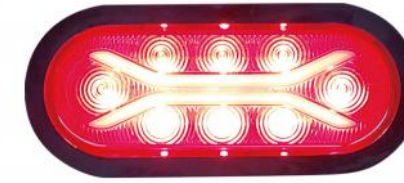

MODEL: EL783



MODEL: EL784

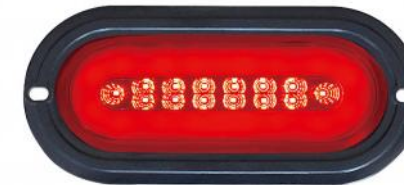

MODEL: EL785

| PART NO. | EL783 | EL784 | EL785 |
|------------------|--------------------------------|--------------------------------|--------------------------------|
| Size | 6" Oval | 6" Oval | 6" Oval |
| Available color | Red, Amber, White | Red, Amber, White | Red, Amber, White |
| Voltage | 12V or 24V | 12V or 24V | 12V or 24V |
| Waterproof | IP67 | IP67 | IP67 |
| Lens Material | ABS/AS | ABS/AS | ABS/AS |
| Cover Material | ABS/AS | ABS/AS | ABS/AS |
| Grommet material | PVC | PVC | PVC |
| Warranty | 1 Years | 1 Years | 1 Years |
| Kit includes: | Grommet, 3 wires pigtail | Grommet, 3 wires pigtail | Grommet, 3 wires pigtail |
| Package | 50pcs, 14.5kgs, 47.5x42x27.5cm | 50pcs, 14.5kgs, 47.5x42x27.5cm | 50pcs, 14.5kgs, 47.5x42x27.5cm |

2.5" Round LED Marker / Clearance Lights

Mounting option: Grommet / Stainless Steel trim ring / Flange cover



MODEL: EL7251



MODEL: EL7252

| MODEL: | EL7251 | EL7252 |
|-----------------|--------------------------------|--------------------------------|
| Size | 2.5" Round | 2.5" Round |
| Diodes | 6/9pcs | 13pcs |
| Available color | Red, Amber, White | Red, Amber, White |
| Voltage | 12V or 24V | 12V or 24V |
| Waterproof | IP67 | IP67 |
| Material | ABS/AS | ABS/AS |
| Warranty | 1 Years | 1 Years |
| Mounting | Grommet | Grommet |
| Wires | 2 wires pigtail | 2 wires pigtail |
| Package | 100pcs/ctn, 7kgs, 46x22.5x37cm | 100pcs/ctn, 7kgs, 46x22.5x37cm |

2.5" Round LED Marker / Clearance Lights

Mounting option: Grommet / Stainless Steel trim ring / Flange cover



MODEL: EL7253



MODEL: EL7254



MODEL: EL7255

| MODEL: | EL7253 | EL7254 | EL7255 |
|-----------------|--------------------------------|--------------------------------|--------------------------------|
| Size | 2.5" Round | 2.5" Round | 2.5" Round |
| Diodes | 4pcs | 4pcs | 9pcs |
| Available color | Red, Amber, White | Red, Amber, White | Red, Amber, White |
| Voltage | 12V or 24V | 12V or 24V | 12V or 24V |
| Waterproof | IP67 | IP67 | IP67 |
| Material | ABS/AS | ABS/AS | ABS/AS |
| Warranty | 1 Years | 1 Years | 1 Years |
| Mounting | Grommet | Grommet | Grommet |
| Wires | 2 wires pigtail | 2 wires pigtail | 2 wires pigtail |
| Package | 100pcs/ctn, 7kgs, 46x22.5x37cm | 100pcs/ctn, 7kgs, 46x22.5x37cm | 100pcs/ctn, 7kgs, 46x22.5x37cm |

2" Round LED Marker / Clearance Lights

Mounting option: Grommet / Stainless Steel trim ring / Flange cover



MODEL: EL7201



MODEL: EL7202

| MODEL: | EL7201 | EL7202 |
|-----------------|--------------------------------|--------------------------------|
| Size | 2" Round | 2" Round |
| Diodes | 9pcs | 13pcs |
| Available color | Red, Amber, White | Red, Amber, White |
| Voltage | 12V or 24V | 12V or 24V |
| Waterproof | IP67 | IP67 |
| Material | ABS/AS | ABS/AS |
| Warranty | 1 Years | 1 Years |
| Mounting | Grommet | Grommet |
| Wires | 2 wires pigtail | 2 wires pigtail |
| Package | 100pcs/ctn, 6.8kgs, 42x22x34cm | 100pcs/ctn, 6.8kgs, 42x22x34cm |

2" Round LED Marker / Clearance Lights

Mounting option: Grommet / Stainless Steel trim ring / Flange cover



MODEL: EL7203



MODEL: EL7204

| MODEL: | EL7203 | EL7204 |
|-----------------|--------------------------------|--------------------------------|
| Size | 2" Round | 2" Round |
| Diodes | 4pcs | 11pcs |
| Available color | Red, Amber, White | Red, Amber, White |
| Voltage | 12V or 24V | 12V or 24V |
| Waterproof | IP67 | IP67 |
| Material | ABS/AS | ABS/AS |
| Warranty | 1 Years | 1 Years |
| Mounting | Grommet | Grommet |
| Wires | 2 wires pigtail | 2 wires pigtail |
| Package | 100pcs/ctn, 6.8kgs, 42x22x34cm | 100pcs/ctn, 6.8kgs, 42x22x34cm |

Tail Light Side Marker



Model: EL7705 (Tail, Stop, DI, Side Marker, Reflector)



Model: EL7706 (Tail, Stop, DI, Side Marker, Reflector)



Model: EL7707 (Side Marker OR Interior Lighting)



Model: EL7708 (Tail, Stop, DI)

| PART NO. | EL7705 & EL7706 | EL7707 | EL7708 |
|------------|--|---|----------------|
| Size | 130x116x66mm | 75X31X10mm | 350x21x16mm |
| Function | Tail , Stop, DI, Side marker, Reflector | Side marker DI, Side marker, Reflector | Tail, Stop, DI |
| Approved | CE | CE | CE |
| Waterproof | IP67 | IP67 | IP67 |
| Voltage | 10-30V | 10-30V | 10-30V |
| Material | PC, ABS | PC, ABS | PC, ABS |
| Mount | Bolt Mounting | Bolt Mounting | Bolt Mounting |
| Warranty | 3 Years | 3 Years | 3 Years |
| Package | 20pcs/ctn | 20pcs/ctn | 20pcs/ctn |

LED Side Marker

2 Sides 2 Colors



MODEL: EL758



MODEL: EL759



MODEL: EL756



MODEL: EL757

| MODEL | EL758 | EL759 | EL756 | EL757 |
|-------------|---------------------|---------------------|---------------------|---------------------|
| Size (inch) | 4.2" | 4.5" | 3" | 4.2" |
| Size (CM) | 106x106x122mm | 113x120x63mm | 78x78x89mm | 106x106x122mm |
| Function | Side Marker Light | Side Marker Light | Side Marker Light | Side Marker Light |
| Color | (Red, Amber, White) | (Red, Amber, White) | (Red, Amber, White) | (Red, Amber, White) |
| Approved | CE, ECE | CE, ECE | CE, ECE | CE, ECE |
| Waterproof | IP67 | IP67 | IP67 | IP67 |
| Voltage | 10-30V | 10-30V | 10-30V | 10-30V |
| Material | PC, ABS | PC, ABS | PC, ABS | PC, ABS |
| Mount | Bolt Mounting | Bolt Mounting | Bolt Mounting | Bolt Mounting |
| Package | 20pcs/ctn | 20pcs/ctn | 20pcs/ctn | 20pcs/ctn |

