

HP 12c Platinum Financial Calculator

User's guide



i n v e n t

Edition 5

HP part number F2231AA-90001

Notice

REGISTER YOUR PRODUCT AT: www.register.hp.com

THIS MANUAL AND ANY EXAMPLES CONTAINED HEREIN ARE PROVIDED "AS IS" AND ARE SUBJECT TO CHANGE WITHOUT NOTICE. HEWLETT-PACKARD COMPANY MAKES NO WARRANTY OF ANY KIND WITH REGARD TO THIS MANUAL, INCLUDING, BUT NOT LIMITED TO, THE IMPLIED WARRANTIES OF MERCHANTABILITY, NON-INFRINGEMENT AND FITNESS FOR A PARTICULAR PURPOSE.

HEWLETT-PACKARD CO. SHALL NOT BE LIABLE FOR ANY ERRORS OR FOR INCIDENTAL OR CONSEQUENTIAL DAMAGES IN CONNECTION WITH THE FURNISHING, PERFORMANCE, OR USE OF THIS MANUAL OR THE EXAMPLES CONTAINED HEREIN.

© 1981-82, 1999, 2002-2005, 2006-07 Hewlett-Packard Development Company, L.P. Reproduction, adaptation, or translation of this manual is prohibited without prior written permission of Hewlett-Packard Company, except as allowed under the copyright laws.

Hewlett-Packard Company
16399 West Bernardo Drive
MS 8-600
San Diego, CA 92127-1899
USA

Printing History

Edition 5

August 2007

Introduction

About This Handbook

This *HP 12c Platinum user's guide* is intended to help you get the most out of your investment in your HP 12c Platinum Programmable Financial Calculator. Although the excitement of acquiring this powerful financial tool may prompt you to set this handbook aside and immediately begin “pressing buttons,” in the long run you'll profit by reading through this handbook and working through the examples it contains.

Following this introduction is a brief section called Making Financial Calculations Easy—which shows you that your HP 12c Platinum does just that! The remainder of this handbook is organized basically into three parts:

- Part I (sections 1 through 7) describes how to use the various financial, mathematics, statistics, and other functions (except for programming) provided in the calculator:
 - Section 1 is about Getting Started. It tells you how to use the keyboard, how to do simple arithmetic calculations and chain calculations, and how to use the storage registers (“memories”).
 - Section 2 tells you how to use the percentage and calendar functions.
 - Section 3 tells you how to use the simple interest, compound interest, and amortization functions.
 - Section 4 tells you how to do discounted cash flow analysis, bond, and depreciation calculations.
 - Section 5 tells you about miscellaneous operating features such as Continuous Memory, the display, and special function keys.
 - Sections 6 and 7 tell you how to use the statistics, mathematics, and number-alteration functions.
- Part II (sections 8 through 11) describes how to use the powerful programming capabilities of the HP 12c Platinum.
- Part III (sections 12 through 16) gives you step-by-step solutions to specialized problems in real estate, lending, savings, investment analysis, and bonds. Some of these solutions can be done manually, while others involve running a program. Since the programmed solutions are both self-contained and step-by-step, you can easily employ them even if you don't care to learn how to create your own programs. But if you *do* start to create your own programs, look over the programs used in the solutions: they contain examples of good programming techniques and practices.

4 Introduction

- The various appendices describe additional details of calculator operation as well as warranty and service information.
- The Function Key Index and Programming Key Index at the back of the handbook can be used as a handy page reference to the comprehensive information inside the manual.

Financial Calculations in the United Kingdom

The calculations for most financial problems in the United Kingdom are identical to the calculations for those problems in the United States — which are described in this handbook. Certain problems, however, require different calculation methods in the United Kingdom than in the United States. Refer to Appendix G for more information.

For More Solutions to Financial Problems

In addition to the specialized solutions found in Sections 12 through 16 of this handbook, many more are available in the optional *HP 12c Platinum Solutions Handbook*. Included are solutions to problems in lending, forecasting, pricing, statistics, savings, investment analysis, personal finance, securities, Canadian mortgages, learning curves in manufacturing, options pricing, and queuing theory. The solutions handbook is available online at the HP 12c Platinum website.

HP would like to thank the following for their contribution:

Gene Wright, Lipscomb University, Nashville, TN, USA

and

Tony Hutchins, Wellington, NZ

Jordi Hidalgo, Barcelona, Spain

Contents

| | |
|---|-----------|
| Introduction | 3 |
| About This Handbook..... | 3 |
| Financial Calculations in the United Kingdom..... | 4 |
| For More Solutions to Financial Problems..... | 4 |
| Part I: Problem Solving | 15 |
| Section 1: Getting Started | 16 |
| Power On and Off..... | 16 |
| Low-Power Indication..... | 16 |
| Adjusting the Display Contrast..... | 16 |
| The Keyboard..... | 16 |
| Keying in Numbers..... | 17 |
| Digit Separators..... | 17 |
| Negative Numbers..... | 17 |
| Keying in Large Numbers..... | 18 |
| Backspacing..... | 18 |
| The CLEAR Keys..... | 19 |
| Undo Operation..... | 20 |
| The RPN and ALG Keys..... | 20 |
| Simple Arithmetic Calculations in RPN Mode..... | 21 |
| Simple Arithmetic Calculations in ALG Mode..... | 22 |
| Chain Calculations in RPN Mode..... | 23 |
| Chain Calculations in ALG Mode..... | 26 |
| Parentheses Calculations..... | 26 |
| Storage Registers..... | 27 |
| Storing and Recalling Numbers..... | 27 |
| Clearing Storage Registers..... | 29 |
| Storage Register Arithmetic..... | 29 |
| Section 2: Percentage and Calendar Functions | 31 |
| Percentage Functions..... | 31 |
| Percentages in RPN Mode..... | 31 |
| Percentages in ALG Mode..... | 32 |
| Net Amount in RPN Mode..... | 33 |
| Net Amount in ALG Mode..... | 33 |
| Percent Difference..... | 34 |
| Percent of Total in RPN Mode..... | 35 |

6 Contents

| | |
|---|-----------|
| Percent of Total in ALG Mode | 36 |
| Calendar Functions | 37 |
| Date Format | 37 |
| Future or Past Dates | 38 |
| Number of Days Between Dates | 40 |
| Section 3: Basic Financial Functions..... | 41 |
| The Financial Registers | 41 |
| Storing Numbers into the Financial Registers | 41 |
| Displaying Numbers in the Financial Registers | 41 |
| Clearing the Financial Registers | 42 |
| Simple Interest Calculations..... | 42 |
| Financial Calculations and the Cash Flow Diagram..... | 44 |
| The Cash Flow Sign Convention..... | 46 |
| The Payment Mode | 46 |
| Generalized Cash Flow Diagrams..... | 47 |
| Compound Interest Calculations..... | 49 |
| Specifying the Number of Compounding Periods and the Periodic Interest Rate | 49 |
| Calculating the Number of Payments or Compounding Periods ... | 49 |
| Calculating the Periodic and Annual Interest Rates..... | 55 |
| Calculating the Present Value | 56 |
| Calculating the Payment Amount..... | 59 |
| Calculating the Future Value..... | 61 |
| Odd-Period Calculations | 63 |
| Amortization | 69 |
| Section 4: Additional Financial Functions | 72 |
| Discounted Cash Flow Analysis: NPV and IRR | 72 |
| Calculating Net Present Value (NPV) | 73 |
| Calculating Internal Rate of Return (IRR) | 78 |
| Reviewing Cash Flow Entries..... | 79 |
| Changing Cash Flow Entries..... | 80 |
| Bond Calculations | 82 |
| Bond Price | 82 |
| Bond Yield..... | 83 |
| Depreciation Calculations | 84 |
| Section 5: Additional Operating Features | 86 |
| Continuous Memory..... | 86 |
| The Display..... | 86 |

| | |
|--|----|
| Status Indicators | 86 |
| Number Display Formats | 87 |
| Scientific Notation Display Format | 88 |
| Special Displays | 89 |
| The $\boxed{X \approx Y}$ Key in RPN Mode..... | 90 |
| The \boxed{LSTx} Key in RPN Mode | 90 |
| Arithmetic Calculations With Constants | 91 |
| Recovering From Errors in Digit Entry..... | 91 |

Section 6: Statistics Functions 93

| | |
|---|----|
| Accumulating Statistics | 93 |
| Correcting Accumulated Statistics | 94 |
| Mean | 94 |
| Standard Deviation..... | 96 |
| Linear Estimation | 97 |
| Weighted Mean..... | 99 |

Section 7: Mathematics and Number-Alteration Functions 100

| | |
|--------------------------------------|-----|
| One-Number Functions | 100 |
| The Power Function in RPN Mode..... | 102 |
| The Power Function in ALG Mode | 102 |

Part II: Programming..... 105

Section 8: Programming Basics 106

| | |
|---|-----|
| Why Use Programs?..... | 106 |
| Creating a Program..... | 106 |
| Running a Program..... | 108 |
| Program Memory | 110 |
| Identifying Instructions in Program Lines | 110 |
| Displaying Program Lines..... | 111 |
| The $\boxed{GTO}000$ Instruction and Program Line 000 | 114 |
| Expanding Program Memory | 114 |
| Setting the Calculator to a Particular Program Line | 116 |
| Executing a Program One Line at a Time | 116 |
| Interrupting Program Execution..... | 119 |
| Pausing During Program Execution | 119 |
| Stopping Program Execution | 124 |

Section 9: Branching and Looping 127

| | |
|------------------------|-----|
| Simple Branching | 127 |
|------------------------|-----|

8 Contents

| | |
|---|------------|
| Looping..... | 128 |
| Conditional Branching | 131 |
| Section 10: Program Editing | 141 |
| Changing the Instruction in a Program Line | 141 |
| Adding Instructions at the End of a Program..... | 142 |
| Adding Instructions within a Program | 144 |
| Adding Instructions by Replacement | 144 |
| Adding Instructions by Branching..... | 146 |
| Section 11: Multiple Programs..... | 151 |
| Storing Another Program | 151 |
| Running Another Program..... | 155 |
| Part III: Solutions | 157 |
| Section 12: Real Estate and Lending..... | 158 |
| Annual Percentage Rate Calculations With Fees..... | 158 |
| Price of a Mortgage Traded at a Discount or Premium..... | 161 |
| Yield of a Mortgage Traded at a Discount or Premium | 163 |
| The Rent or Buy Decision | 165 |
| Deferred Annuities | 171 |
| Section 13: Investment Analysis..... | 174 |
| Partial-Year Depreciation..... | 174 |
| Straight-Line Depreciation..... | 174 |
| Declining-Balance Depreciation | 179 |
| Sum-of-the-Years-Digits Depreciation | 183 |
| Full- and Partial-Year Depreciation with Crossover | 187 |
| Excess Depreciation | 194 |
| Modified Internal Rate of Return..... | 195 |
| Black-Scholes Formula for Valuing European Options..... | 197 |
| Section 14: Leasing..... | 205 |
| Advance Payments..... | 205 |
| Solving for Payment..... | 205 |
| Solving for Yield | 209 |
| Advance Payments With Residual | 212 |
| Solving for Payment..... | 212 |
| Solving for Yield | 215 |

| | |
|---|------------|
| Section 15: Savings | 217 |
| Nominal Rate Converted to Effective Rate | 217 |
| Effective Rate Converted to Nominal Rate | 219 |
| Continuous Rate Converted to Effective Rate..... | 220 |
| Section 16: Bonds | 221 |
| 30/360 Day Basis Bonds | 221 |
| Annual Coupon Bonds..... | 226 |
| Appendices | 231 |
| Appendix A: RPN and the Stack | 232 |
| Getting Numbers Into the Stack: The ENTER Key..... | 233 |
| Termination of Digit Entry | 234 |
| Stack Lift..... | 234 |
| Rearranging Numbers in the Stack | 234 |
| The X\leftrightarrowY Key | 234 |
| The R\downarrow Key | 235 |
| One-Number Functions and the Stack | 235 |
| Two-Number Functions and the Stack..... | 235 |
| Mathematics Functions | 236 |
| Percentage Functions..... | 236 |
| Calendar and Financial Functions..... | 237 |
| The LAST X Register and the LSTX Key | 238 |
| Chain Calculations in RPN Mode | 239 |
| Arithmetic Calculations with Constants | 240 |
| Appendix B: Algebraic Mode (ALG) | 242 |
| Simple Arithmetic Calculations in ALG Mode | 242 |
| Keying in Negative Numbers (CHS) | 243 |
| Chain Calculations in ALG Mode | 243 |
| The LSTX Key in ALG Mode | 244 |
| The History Stack in ALG Mode..... | 244 |
| Parentheses Calculations | 245 |
| Percentage Functions..... | 246 |
| Percent Difference | 246 |
| Percent of Total | 247 |
| The Power Function | 247 |
| Appendix C: More About IRR | 248 |
| Appendix D: Error Conditions | 250 |
| Error 0: Mathematics | 250 |
| Error 1: Storage Register Overflow | 251 |

Error 2: Statistics..... 251
 Error 3: IRR..... 251
 Error 4: Memory 251
 Error 5: Compound Interest 252
 Error 6: Storage Registers 253
 Error 7: IRR 253
 Error 8: Calendar 254
 Error 9: Service 254
 Pr Error 254

Appendix E: Formulas Used..... 255

Percentage..... 255
 Interest 255
 Simple Interest 255
 Compound Interest 256
 Amortization 256
 Discounted Cash Flow Analysis 257
 Net Present Value 257
 Internal Rate of Return..... 257
 Calendar..... 257
 Actual Day Basis..... 257
 30/360 Day Basis..... 257
 Bonds 258
 Black-Scholes Formula for Valuing European Options 259
 Depreciation 259
 Straight-Line Depreciation..... 260
 Sum-of-the-Years-Digits Depreciation 260
 Declining-Balance Depreciation 260
 Modified Internal Rate of Return..... 261
 Advance Payments..... 261
 Interest Rate Conversions 261
 Finite Compounding..... 261
 Continuous Compounding..... 261
 Statistics 262
 Mean 262
 Weighted Mean 262
 Linear Estimation..... 262
 Standard Deviation 262
 Factorial 262
 The Rent or Buy Decision 263

Appendix F: Batteries, Warranty, and Service Information.. 264

Batteries 264

| | |
|--|------------|
| Low-Power Indication | 264 |
| Installing a New Batteries | 264 |
| Verifying Proper Operation (Self-Tests) | 266 |
| Perchlorate Material – special handling may apply. | 267 |
| HP Limited Hardware Warranty and Customer Care | 268 |
| Customer Care..... | 269 |
| Regulatory Information | 272 |
| Disposal of Waste Equipment by Users in Private Household in the European Union | 274 |
| Appendix G: United Kingdom Calculations | 275 |
| Mortgages | 275 |
| Annual Percentage Rate (APR) Calculations..... | 276 |
| Bond Calculations | 276 |
| Function Key Index | 278 |
| Programming Key Index..... | 282 |
| Subject Index | 284 |

Making Financial Calculations Easy

Before you begin to read through this handbook, let's take a look at how easy financial calculations can be with your hp 12c platinum. While working through the examples below, don't be concerned about learning how to use the calculator; we'll cover that thoroughly beginning with Section 1.

Example 1: Suppose you want to ensure that you can finance your daughter's college education 14 years from today. You expect that the cost will be about \$6,000 a year (\$500 a month) for 4 years. Assume she will withdraw \$500 at the beginning of each month from a savings account. How much would you have to deposit into the account when she enters college if the account pays 6% annual interest compounded monthly?

This is an example of a compound interest calculation. All such problems involve at least three of the following quantities:

- n : the *number* of compounding periods.
- i : the *interest rate* per compounding period.
- PV : the *present value* of a compounded amount.
- PMT : the *periodic payment* amount.
- FV : the *future value* of a compounded amount.

In this particular example:

- n is 4 years \times 12 periods per year = 48 periods.
- i is 6% per year \div 12 periods per year = 0.5% per period.
- PV is the quantity to be calculated — the present value when the financial transaction begins.
- PMT is \$500.
- FV is zero, since by the time your daughter graduates she (hopefully!) will not need any more money.

To begin, turn the calculator on by pressing the **ON** key. Then, press the keys shown in the **Keystrokes** column below.*

* If you are not familiar with the use of an hp calculator keyboard, refer to the description on pages 16 and 17.

Note: A battery symbol (🔋) shown in the upper-left corner of the display when the calculator is on signifies that the available battery power is nearly exhausted. To install new batteries, refer to Appendix F.

The calendar functions and nearly all of the financial functions take some time to produce an answer. (This is typically just a few seconds, but the **i**, **AMORT**, **IRR**, and **YTM** functions could require a half-minute or more.) During these calculations, the word **running** flashes in the display to let you know that the calculator is running.

| Keystrokes | Display | |
|--|----------------|---|
| f CLEAR REG f 2 | 0 . 00 | Clears previous data inside the calculator and sets display to show two decimal places. |
| 4 g 12X | 48 . 00 | Calculates and stores the number of compounding periods. |
| 6 g 12÷ | 0 . 50 | Calculates and stores the periodic interest rate. |
| 500 PMT | 500 . 00 | Stores periodic payment amount. |
| g BEG | 500 . 00 | Sets payment mode to Begin. |
| PV | -21 , 396 . 61 | Amount required to be deposited.* |

Example 2: We now need to determine how to accumulate the required deposit by the time your daughter enters college 14 years from now. Let’s say that she has a paid-up \$5,000 insurance policy that pays 5.35%, compounded annually. How much would it be worth by the time she enters college?

In this example, we need to calculate *FV*, the future value.

| Keystrokes | Display | |
|----------------------------------|----------------|---|
| f CLEAR FIN | -21 , 396 . 61 | Clears previous financial data inside the calculator. |
| 14 n | 14 . 00 | Stores the number of compounding periods. |
| 5.35 i | 5 . 35 | Stores the periodic interest rate. |
| 5000 CHS PV | -5 , 000 . 00 | Stores the present value of the policy. |

* Don’t be concerned now about the minus sign in the display. That and other details will be explained in Section 3.

14 Making Financial Calculations Easy

Keystrokes

FV

Display

10,371.79 Value of policy in 14 years.

Example 3: The preceding example showed that the insurance policy will provide about half the required amount. An additional amount must be set aside to provide the balance ($21,396.61 - 10,371.79 = 11,024.82$). Suppose you make monthly payments, beginning at the end of next month, into an account that pays 6% annually, compounded monthly. What payment amount would be required in order to accumulate \$11,024.82 in the 14 years remaining?

Keystrokes

f **CLEAR** **FIN**

10,371.79

Clears previous financial data inside the calculator.

14 **g** **12x**

168.00

Calculates and stores the number of compounding periods.

6 **g** **12÷**

0.50

Calculates and stores the periodic interest rate.

11024.82 **FV**

11,024.82

Stores the future value required.

g **END**

11,024.82

Sets payment mode to End.

PMT

-42.03

Monthly payment required.

Example 4: Suppose you cannot find a bank that currently offers an account with 6% annual interest compounded monthly, but you can afford to make \$45 monthly payments. What is the minimum interest rate that will enable you to accumulate the required amount?

In this problem, we do not need to clear the previous financial data inside the calculator, since most of it is unchanged from the preceding example.

Keystrokes

45 **CHS** **PMT**

-45.00

Stores payment amount.

i

0.43

Periodic interest rate.

RCL **g** **12÷**

5.13

Annual interest rate.

This is only a small sampling of the many financial calculations that can now be done easily with your hp 12c platinum. To begin learning about this powerful financial tool, just turn the page.

Part I
Problem Solving

Section 1

Getting Started

Power On and Off

To begin using your hp 12c platinum, press the **ON** key*. Pressing **ON** again turns the calculator off. If not manually turned off, the calculator will turn off automatically 12 minutes after it was last used.

Low-Power Indication

A battery symbol (🔋) shown in the upper-left corner of the display when the calculator is on signifies that the available battery power is nearly exhausted. To replace the batteries, refer to Appendix F.

Adjusting the Display Contrast

The display's readability depends on lighting, your viewing angle, and the display contrast setting. You can adjust the display contrast, by holding down the **f** key and pressing **+** or **-**.

The Keyboard

Many keys on the hp 12c platinum perform two or even three functions. The primary function of a key is indicated by the characters printed in white on the upper face of the key. The alternate function(s) of a key are indicated by the characters printed in gold above the key and the characters printed in blue on the lower face of the key. These alternate functions are specified by pressing the appropriate *prefix* key before the function key:

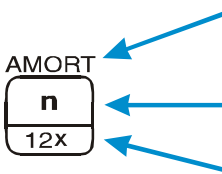
- 
- To specify the alternate function printed in gold above a key, press the gold prefix key (**f**), then press the function key.
 - To specify the primary function printed on the upper face of a key, press the key alone.
 - To specify the alternate function printed in blue on the lower face of a key, press the blue prefix key (**g**), then press the function key.

* Note that the **ON** key is lower than the other keys to help prevent its being pressed inadvertently.

Throughout this handbook, references to the functions shown on the keyboard in gold under the bracket labeled “CLEAR” appear throughout this handbook preceded by the word “CLEAR” (for example, “The CLEAR $\overline{\text{REG}}$ function ...” or “Pressing $\overline{\text{f}}$ CLEAR $\overline{\text{REG}}$...”).

If you press the $\overline{\text{f}}$ or $\overline{\text{g}}$ prefix key mistakenly, you can cancel it by pressing $\overline{\text{f}}$ CLEAR $\overline{\text{PREFIX}}$. This can also be pressed to cancel the $\overline{\text{STO}}$, $\overline{\text{RCL}}$, and $\overline{\text{GTO}}$ keys. (These keys are “prefix” keys in the sense that other keys must be pressed after them in order to execute the corresponding function.) Since the $\overline{\text{PREFIX}}$ key is also used to display the mantissa (all 10 digits) of a displayed number, the mantissa of the number in the display will appear for a moment after the $\overline{\text{PREFIX}}$ key is released.

Pressing the $\overline{\text{f}}$ or $\overline{\text{g}}$ prefix key turns on the corresponding status indicator — **f** or **g** — in the display. Each indicator turns off when you press a function key (executing an alternate function of that key), another prefix key, or $\overline{\text{f}}$ CLEAR $\overline{\text{PREFIX}}$.

Keying in Numbers

To key a number into the calculator, press the digit keys in sequence, just as if you were writing the number on paper. A decimal point must be keyed in (using the decimal point key) if it is part of the number unless it appears to the right of the last digit.

Digit Separators

As a number is keyed in, each group of three digits to the left of the decimal point is automatically separated in the display. When the calculator is first turned on after coming from the factory — or after Continuous Memory is reset — the decimal point in displayed numbers is a dot, and the separator between each group of three digits is a comma. If you wish, you can set the calculator to display a comma for the decimal point and a dot for the three-digit separator. To do so, turn the calculator off, then press and hold down the $\overline{\text{.}}$ key while you press $\overline{\text{ON}}$. Doing so again sets the calculator to use the original digit separators in the display.

Negative Numbers

To make a displayed number negative — either one that has just been keyed in or one that has resulted from a calculation — simply press $\overline{\text{CHS}}$ (*change sign*) —. When the display shows a negative number — that is, the number is preceded by a minus sign — pressing $\overline{\text{CHS}}$ removes the minus sign from the display, making the number positive.

Keying in Large Numbers

Since the display cannot show more than 10 digits of a number, numbers greater than 9,999,999,999 cannot be entered into the display by keying in all the digits in the number. However, such numbers can be easily entered into the display if the number is expressed in a mathematical shorthand called “scientific notation.” To convert a number into scientific notation, move the decimal point until there is only one digit (a nonzero digit) to its left. The resulting number is called the “mantissa” of the original number, and the number of decimal places you moved the decimal point is called the “exponent” of the original number. If you moved the decimal point to the left, the exponent is positive; if you moved the decimal point to the right (this would occur for numbers less than one), the exponent is negative. To key the number into the display, simply key in the mantissa, press **EE** (enter exponent), then key in the exponent. If the exponent is negative, press **CHS** after pressing **EE**.

For example, to key in \$1,781,400,000,000, we move the decimal point 12 places to the left, giving a mantissa of 1.7814 and an exponent of 12:

| Keystrokes | Display | |
|---------------------|----------------|--|
| 1.7814 EE 12 | 1.7814 12 | 1,781,400,000,000 entered in scientific notation. |

Numbers entered in scientific notation can be used in calculations just like any other number.

Backspacing

While you are entering a number, pressing **9** **←** deletes the last character you entered. After performing a calculation, pressing **9** **←** deletes the current number.

| Keystrokes (RPN mode) | Display | |
|---|----------------|---|
| 12345 9 ← 9 ← .63 ENTER | 123.63 | Correcting removes the 4 and 5. 9 ← clears the most recent digit entered. |
| 5 + | 128.63 | |
| 9 ← | 0.00 | Clears the calculator line. |

| Keystrokes (ALG mode) | Display | |
|--|----------|--|
| 12345 $\boxed{g} \boxed{\leftarrow} \boxed{g} \boxed{\leftarrow}$.63 $\boxed{+}$ | 123 . 63 | Correcting removes the 4 and 5. $\boxed{g} \boxed{\leftarrow}$ clears the most recent digit entered. |
| 5 $\boxed{=}$ | 128 . 63 | $\boxed{=}$ is also labeled the $\boxed{\text{ENTER}}$ key. |
| $\boxed{g} \boxed{\leftarrow}$ | 0 . 00 | Clears the calculator line. |

The CLEAR Keys

Clearing a register or the display replaces the number in it with zero. Clearing program memory replaces the instructions there with $\boxed{g} \boxed{\text{GTO}} 000$. There are several clearing operations on the hp 12c platinum, as shown in the table below:

| Key(s) | Clears: |
|--|---|
| $\boxed{\text{CLx}}$ | Display and X-register. |
| $\boxed{f} \boxed{\text{CLEAR}} \boxed{\Sigma}$ | Statistics registers (R_1 through R_6), stack registers, and display. |
| $\boxed{f} \boxed{\text{CLEAR}} \boxed{\text{PRGM}}$ | Program memory (only when pressed in Program mode). |
| $\boxed{f} \boxed{\text{CLEAR}} \boxed{\text{FIN}}$ | Financial registers. |
| $\boxed{f} \boxed{\text{CLEAR}} \boxed{\text{REG}}$ | Data storage registers, financial registers, stack and LAST X registers, and display. |

Note: In ALG mode, it is a good idea to begin calculations by pressing $\boxed{\text{CLx}} \boxed{\text{CLx}}$. This will ensure that there are no pending arithmetic calculations that might interfere with the solution of a new problem. The reason this key is pressed twice is that pressing it the first time clears the display and X-register only, allowing you to correct an erroneous entry by keying in a correct number. The second press of $\boxed{\text{CLx}}$ will clear any pending operations as well. Pressing the $\boxed{=}$ key is another way to ensure that there are no pending operations before beginning a new calculation, since the $\boxed{=}$ key will evaluate any pending expressions.

Undo Operation

Every time you press CLx , $\text{g} \leftarrow$, f CLEAR REG , $\text{f CLEAR } \Sigma$ or f CLEAR FIN key to clear data, the ↶ status indicator appears in the display. This means you can press $\text{g} \curvearrowright$ to *undo* the last operation (i.e., to recover the data.)

Note: the Undo function is only available immediately after data has been cleared. When the Undo indicator is turned off no operation can be undone.

The RPN and ALG Keys

The calculator can be set to perform arithmetic operations in either RPN (Reverse Polish Notation) or ALG (Algebraic) mode.

In Reverse Polish Notation (RPN) mode, the intermediate results of calculations are stored automatically, hence you do not have to use parentheses.

In algebraic (ALG) mode, you perform addition, subtraction, multiplication, and division in the traditional way, using parentheses if needed.

To select RPN mode: Press f RPN to set the calculator to RPN mode. When the calculator is in RPN mode, the **RPN** status indicator is lit.

To select ALG mode: Press f ALG to set the calculator to ALG mode. When the calculator is in ALG mode, the **ALG** status indicator is lit.

Example

Suppose you want to calculate $1 + 2 = 3$.

In RPN mode, you enter the first number, press the ENTER key, enter the second number, and finally press the arithmetic operator key: + .

In ALG mode, you enter the first number, press + , enter the second number, and finally press the equals key: = . Don't forget to press CLx CLx before doing the calculation.

| RPN mode | ALG mode |
|-------------------------------|---------------------------|
| 1 ENTER 2 + | 1 + 2 = |

You can choose either ALG (Algebraic) or RPN (Reverse Polish Notation) mode for your calculations. Throughout the manual, most examples are shown in both modes. The Keystrokes column will indicate RPN mode or ALG mode where the keystrokes differ. When the keystrokes are the same, the column is simply titled "Keystrokes".

Simple Arithmetic Calculations in RPN Mode

In RPN mode, any simple arithmetic calculation involves two numbers and an operation — addition, subtraction, multiplication, or division. To do such a calculation on your hp 12c platinum, you first tell the calculator the two numbers, *then* tell the calculator the operation to be performed. The answer is calculated when the operation key ($\boxed{+}$, $\boxed{-}$, $\boxed{\times}$, or $\boxed{\div}$) is pressed.

The two numbers should be keyed into the calculator in the order they would appear if the calculation were written down on paper left-to-right. After keying in the first number, press the $\boxed{\text{ENTER}}$ key to tell the calculator that you have completed entering the number. Pressing $\boxed{\text{ENTER}}$ separates the second number to be entered from the first number already entered.

In summary, to perform an arithmetic operation:

1. Key in the first number.
2. Press $\boxed{\text{ENTER}}$ to separate the second number from the first.
3. Key in the second number.
4. Press $\boxed{+}$, $\boxed{-}$, $\boxed{\times}$, or $\boxed{\div}$ to perform the desired operation.

For example to calculate $13 \div 2$, proceed as follows:

| Keystrokes (RPN mode) | Display | |
|----------------------------------|----------------|---|
| 13 | 13. | Keys the first number into the calculator. |
| $\boxed{\text{ENTER}}$ | 13.00 | Pressing $\boxed{\text{ENTER}}$ separates the second number from the first. |
| 2 | 2. | Keys the second number into the calculator. |
| $\boxed{\div}$ | 6.50 | Pressing the operation key calculates the answer. |

Notice that after you pressed $\boxed{\text{ENTER}}$, two zeroes appeared following the decimal point. This is nothing magical: the calculator's display is currently set to show two decimal places of every number that has been entered or calculated. Before you pressed $\boxed{\text{ENTER}}$, the calculator had no way of knowing that you had completed entering the number, and so displayed only the digits you had keyed in. Pressing $\boxed{\text{ENTER}}$ tells the calculator that you have completed entering the number: it *terminates digit entry*. You need not press $\boxed{\text{ENTER}}$ after keying in the second number because the $\boxed{+}$, $\boxed{-}$, $\boxed{\times}$ and $\boxed{\div}$ keys also terminate digit entry. (In fact, all keys terminate digit entry except for digit entry keys — digit keys, $\boxed{\cdot}$, $\boxed{\text{CHS}}$, and $\boxed{\text{EEX}}$ — and prefix keys — $\boxed{\text{f}}$, $\boxed{\text{g}}$, $\boxed{\text{STO}}$, $\boxed{\text{RCL}}$, and $\boxed{\text{GTO}}$.)

Simple Arithmetic Calculations in ALG Mode

In ALG mode, any simple arithmetic calculation involves two numbers and an operation — addition, subtraction, multiplication, or division. To do such a calculation on your hp 12c platinum, you tell the calculator the first number, then the operation to be performed, and then tell the calculator the second number. The answer is calculated when the equals key ($\boxed{=}$) is pressed.

For example, to calculate $21.1 + 23.8$, do the following:

| Keystrokes (ALG mode) | Display | |
|---------------------------|---------|--|
| $\boxed{CLX} \boxed{CLX}$ | 0 . 00 | Clears any pending operations. |
| 21.1 $\boxed{+}$ | 21 . 10 | Keys in the first number and prepares to add the second. |
| 23.8 | 23 . 8 | Keys the second number. |
| $\boxed{=}$ | 44 . 90 | $\boxed{=}$ completes the calculation. |

Once a calculation has been completed:

- pressing another digit key starts a new calculation, or
- pressing an operator key continues the calculation.

| Keystrokes (ALG mode) | Display | |
|---|----------|--|
| $\boxed{CLX} \boxed{CLX}$ | 0 . 00 | Clears any pending operations. |
| 77.35 $\boxed{-}$ | 77 . 35 | |
| 90.89 $\boxed{=}$ | -13 . 54 | $\boxed{=}$ completes the calculation. |
| 65 $\boxed{g} \boxed{\sqrt{x}} \boxed{\times} \boxed{12} \boxed{=}$ | 96 . 75 | New calculation: $\sqrt{65} \times 12$ |
| $\boxed{\div} \boxed{3.5} \boxed{=}$ | 27 . 64 | Calculates $96.75 \div 3.5$ |

You can also do long calculations without pressing $\boxed{=}$ after each intermediate calculation: just press it at the end. The operators perform from left to right, in the order you enter them. Note that if you have just pressed $\boxed{=}$, there is no need to press $\boxed{CLX} \boxed{CLX}$ before starting a new calculation — the $\boxed{=}$ key will have completed any pending operations.

Chain Calculations in RPN Mode

Whenever the answer has just been calculated and is therefore in the display, you can perform another operation with this number by simply keying in the second number and then pressing the operation key: you need *not* press **ENTER** to separate the second number from the first. This is because when a number is keyed in after a function key (such as **+**, **-**, **×**, **÷**, etc.) is pressed, the result of that prior calculation is stored inside the calculator — just as when the **ENTER** key is pressed. *The only time you must press the **ENTER** key to separate two numbers is when you are keying them both in, one immediately following the other.*

The hp 12c platinum is designed so that each time you press a function key in RPN mode, the calculator performs the operation *then* — not later — so that you see the results of all intermediate calculations, as well as the “bottom line.”

Example: Suppose you’ve written three checks without updating your checkbook, and you’ve just deposited your paycheck for \$1,053 into your checking account. If your latest balance was \$58.33 and the checks were written for \$22.95, \$13.70, and \$10.14, what is the new balance?

Solution: When written down on paper, this problem would read

$$58.33 - 22.95 - 13.70 - 10.14 + 1053$$

| Keystrokes (RPN mode) | Display | |
|--------------------------|---------|---|
| 58.33 | 58.33 | Keys the first number. |
| ENTER | 58.33 | Pressing ENTER separates the second number from the first. |
| 22.95 | 22.95 | Keys in the second number. |
| - | 35.38 | Pressing - subtracts the second number from the first. The calculator displays the result of this calculation, which is the balance after subtracting the first check. |
| 13.7 | 13.7 | Keys in the next number. Since a calculation has just been performed, do not press ENTER ; the next number entered (13.7) is automatically separated from the one previously in the display (35.38). |

24 Section 1: Getting Started

Keystrokes (RPN mode)

Display

| | | |
|---------|---------------------|--|
| □ | 21 . 68 | Pressing □ subtracts the number just entered from the number previously in the display. The calculator displays the result of this calculation, which is the balance after subtracting the second check. |
| 10.14 □ | 11 . 54 | Keys in the next number and subtracts it from the previous balance. The new balance appears in the display. (It's getting rather low!) |
| 1053 □ | 1 , 064 . 54 | Keys in the next number — the paycheck deposited — and adds it to the previous balance. The new, current balance appears in the display. |

The preceding example demonstrates how the hp 12c platinum calculates just as you would using pencil and paper (except a lot faster!):

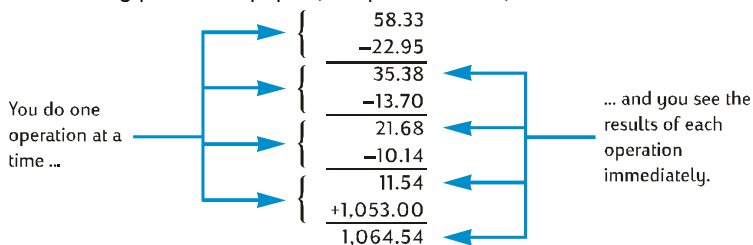

Let's see this happening in a different type of calculation — one that involves multiplying groups of two numbers and then adding the results. (This is the type of calculation that would be required to total up an invoice consisting of several items with different quantities and different prices.)

For example, consider the calculation of $(3 \times 4) + (5 \times 6)$. If you were doing this on paper, you would do the multiplication in the first parentheses, then the multiplication in the second parentheses, and finally add the results of the two multiplications:

$$\begin{array}{c}
 \cancel{(3 \times 4)} + \cancel{(5 \times 6)} \\
 \textcircled{1} 12 + \textcircled{2} 30 \\
 \textcircled{3} 42
 \end{array}$$

Your hp 12c platinum calculates the answer in just the same way in RPN mode:

| Keystrokes (RPN mode) | Display | |
|---|---------|---|
| 3 <input type="text" value="ENTER"/> 4 <input type="text" value="X"/> | 12.00 | Step 1: Multiply the numbers in the first parentheses. |
| 5 <input type="text" value="ENTER"/> 6 <input type="text" value="X"/> | 30.00 | Step 2: Multiply the numbers in the second parentheses. |
| <input type="text" value="+"/> | 42.00 | Step 3: Add the results of the two multiplications. |

Notice that before doing step 2, you did not need to store or write down the result of step 1: it was stored inside the calculator automatically. And after you keyed in the 5 and the 6 in step 2, the calculator was holding two numbers (12 and 5) inside for you, in addition to the 6 in the display. (The hp 12c platinum can hold a total of three numbers inside, in addition to the number in the display.) After step 2, the calculator was still holding the 12 inside for you, in addition to the 30 in the display. You can see that the calculator holds the number for you, just as you would have them written on paper, and then calculates with them at the proper time, just as you would yourself.* But with the hp 12c platinum, you don't need to write down the results of an intermediate calculation, and you don't even need to manually store it and recall it later.

By the way, notice that in step 2 you needed to press again. This is simply because you were again keying in two numbers immediately following each other, without performing a calculation in between.

To check your understanding of how to calculate with your hp 12c platinum, try the following problems yourself. Although these problems are relatively simple, more complicated problems can be solved using the same basic steps. If you have difficulty obtaining the answers shown, review the last few pages.

$$(3 + 4) \times (5 + 6) = 77.00$$

$$\frac{(27 - 14)}{(14 + 38)} = 0.25$$

$$\frac{5}{3 + 16 + 21} = 0.13$$

* Although you don't *need* to know just how these numbers are stored and brought back at just the right time, if you're interested you can read all about it in Appendix A. By gaining a more complete understanding of the calculator's operation, you'll use it more efficiently and confidently, yielding a better return on the investment in your hp 12c platinum.

Chain Calculations in ALG Mode

To do a chain calculation, you don't need to press [=] after each operation, but only at the very end.

For instance, to calculate $\frac{750 \times 12}{360}$ you can enter either:

- 750 [X] 12 [=] ÷ 360 [=] or
- 750 [X] 12 ÷ 360 [=]

In the second case, the ÷ key acts like the [=] key by displaying the result of 750×12 .

Here's a longer chain calculation: $\frac{456 - 75}{18.5} \times \frac{68}{1.9}$

This calculation can be written as: $456 - 75 \div 18.5 \times 68 \div 1.9$. Watch what happens in the display as you key it in:

Keystrokes (ALG mode)

Display

[CLx][CLx]

0.00

Clears any pending operations.

456[-]75[÷]

381.00

Subtracts 75 from 456.

18.5[X]

20.59

Divides 381 by 18.5.

68[÷]

1,400.43

Multiplies by 68.

1.9[=]

737.07

Divides by 1.9 and displays the result.

Parentheses Calculations

In ALG mode, parentheses can be used in calculations to change the order in which operations are evaluated. When there are pending open parentheses, the () status indicator will be shown in the display. As open parentheses are closed, the expression contained within the parentheses is evaluated, from left to right. The final result of a calculation will be displayed when you press the [=] key, and then any pending parentheses will be closed. You can't use more than 13 pending (opened) parentheses at the same time.

For example, suppose you want to calculate:

$$\frac{8}{(5 - 1)}$$

Keying $8 \div 5 - 1$ will calculate $8 \div 5$ first and then the result (1.6) will have 1 subtracted from it (resulting in 0.6), which is not what is intended.

If you want to calculate $\frac{8}{(5-1)}$, use the following keystrokes:

| Keystrokes (ALG mode) | Display | |
|--|----------------|--------------------------------|
| $\boxed{\text{CLX}} \boxed{\text{CLX}}$ | 0 . 00 | Clears any pending operations. |
| $8 \boxed{\div} \boxed{9} \boxed{[} \boxed{5} \boxed{-}$ | 5 . 00 | No calculation is done. |
| $1 \boxed{9} \boxed{)}$ | 4 . 00 | Calculates $5 - 1$. |
| $\boxed{=}$ | 2 . 00 | Calculates $\frac{8}{(5-1)}$. |

Storage Registers

Numbers (data) in the hp 12c platinum are stored in memories called “storage registers” or simply “registers.” (The singular term “memory” is sometimes used in this handbook to refer to the entire collection of storage registers.) Four special registers are used for storing numbers during calculations (these “stack registers” are described in Appendix A), and another (called the “LAST X” register) is used for storing the number last in the display before an operation is performed in RPN mode. In addition to these registers into which numbers are stored automatically, up to 20 “data storage” registers are available for manual storage of numbers. These data storage registers are designated R_0 through R_9 and R_{10} through R_{19} . Still other storage registers — referred to as the “financial registers” — are reserved for numbers used in financial calculations.

Storing and Recalling Numbers

To store the number from the display into a data storage register:

1. Press $\boxed{\text{STO}}$ (*store*).
2. Key in the register number: 0 through 9 for registers R_0 through R_9 , or $\boxed{\cdot}0$ through $\boxed{\cdot}9$ for registers R_{10} through R_{19} .

Similarly, to recall a number from a storage register into the display, press $\boxed{\text{RCL}}$ (*recall*), then key in the register number. This copies the number from the storage register into the display; the number remains unaltered in the storage register. Furthermore, when this is done, the number previously in the display is automatically held inside the calculator for a subsequent calculation, just as the number in the display is held when you key in another number.

28 Section 1: Getting Started

Example: Before you leave to call on a customer interested in your personal computer, you store the cost of the computer (\$1,250) and also the cost of a printer (\$500) in data storage registers. Later, the customer decides to buy six computers and one printer. You recall the cost of the computer, multiply by the quantity ordered, and then recall and add the cost of the printer to get the total invoice.

| Keystrokes | Display | |
|-----------------------------|----------|--|
| 1250 $\boxed{\text{STO}}$ 0 | 1,250.00 | Stores the cost of the computer in R_0 . |
| 500 $\boxed{\text{STO}}$ 2 | 500.00 | Stores the cost of the printer in R_2 . |
| $\boxed{\text{ON}}$ | | Turns the calculator off. |

Later that same day ...

| Keystrokes (RPN mode) | Display | |
|--------------------------|----------|---|
| $\boxed{\text{ON}}$ | 500.00 | Turns the calculator back on. |
| $\boxed{\text{RCL}}$ 0 | 1,250.00 | Recalls the cost of the computer to the display. |
| 6 $\boxed{\times}$ | 7,500.00 | Multiplies the quantity ordered to get the cost of the computers. |
| $\boxed{\text{RCL}}$ 2 | 500.00 | Recalls the cost of the printer to the display. |
| $\boxed{+}$ | 8,000.00 | Total invoice. |

| Keystrokes (ALG mode) | Display | |
|------------------------------------|----------|--|
| $\boxed{\text{ON}}$ | 500.00 | Turns the calculator back on. |
| $\boxed{\text{RCL}}$ 0 | 1,250.00 | Recalls the cost of the computer to the display. |
| $\boxed{\times}$ 6 | 6. | Multiplies by the quantity ordered to get the cost of the computers. |
| $\boxed{+}$ $\boxed{\text{RCL}}$ 2 | 500.00 | Recalls the cost of the printer to the display. |
| $\boxed{=}$ | 8,000.00 | Total invoice. |

Clearing Storage Registers

To clear a single storage register — that is, to replace the number in it with zero — merely store zero into it. You need not clear a storage register before storing data into it; the storing operation automatically clears the register before the data is stored.

To clear *all* storage registers at once — including the financial registers, the stack registers, and the LAST X register — press $\boxed{\text{f}}\boxed{\text{CLEAR}}\boxed{\text{REG}}\boxed{*}$. This also clears the display.

All storage registers are also cleared when Continuous Memory is reset (as described on page 86).

Storage Register Arithmetic

Suppose you wanted to perform an arithmetic operation with the number in the display and the number in a storage register, then store the result back into the same register without altering the number in the display. The hp 12c platinum enables you to do all this in a single operation:

1. Press $\boxed{\text{STO}}$.
2. Press $\boxed{+}$, $\boxed{-}$, $\boxed{\times}$, or $\boxed{\div}$ to specify the desired operation.
3. Key in the register number.

When storage register arithmetic is performed, the new number in the register is determined according to the following rule:

$$\begin{array}{l} \text{number now} \\ \text{in register} \end{array} = \begin{array}{l} \text{number formerly} \\ \text{in register} \end{array} \left\{ \begin{array}{l} + \\ - \\ \times \\ \div \end{array} \right\} \text{number in display}$$

Storage register arithmetic is possible with only registers R_0 through R_4 .

Example: In the example on page 23, we updated the balance in your checkbook. Let's suppose that because data is stored indefinitely in your calculator's Continuous Memory, you keep track of your checking account balance in the calculator. You could use storage register arithmetic to quickly update the balance after depositing or writing checks.

Keystrokes

58.33 $\boxed{\text{STO}}$ 0

Display

58.33

Stores the current balance in register R_0 .

* $\boxed{\text{f}}\boxed{\text{CLEAR}}\boxed{\text{REG}}$ is not programmable.

30 Section 1: Getting Started

Keystrokes

22.95 **STO** **-** 0

13.7 **STO** **-** 0

10.14 **STO** **-** 0

1053 **STO** **+** 0

RCL 0

Display

22.95

13.70

10.14

1,053.00

1,064.54

Subtracts the first check from the balance in R_0 . Note that the display continues to show the amount subtracted; the answer is placed only in R_0 .

Subtracts the second check.

Subtracts the third check.

Adds the deposit.

Recalls the number in R_0 to check the new balance.

Section 2

Percentage and Calendar Functions

Percentage Functions

The hp 12c platinum includes three keys for solving percentage problems: $\boxed{\%}$, $\boxed{\Delta\%}$, and $\boxed{\%T}$. You don't need to convert percentages to their decimal equivalents; this is done automatically when you press any of these keys. Thus, 4% need not be changed to 0.04; you key it in the way you see and say it: 4 $\boxed{\%}$.

Percentages in RPN Mode

In RPN mode, to find the amount corresponding to a percentage of a number:

1. Key in the base number.
2. Press $\boxed{\text{ENTER}}$.
3. Key in the percentage.
4. Press $\boxed{\%}$.

For example, to find 14% of \$300:

| Keystrokes (RPN mode) | Display | |
|--------------------------|----------|--|
| 300 | 300 . | Keys in the base number. |
| $\boxed{\text{ENTER}}$ | 300 . 00 | Pressing $\boxed{\text{ENTER}}$ separates the next number entered from the first number, just as when an ordinary arithmetic calculation is performed. |
| 14 | 14 . | Keys in the percentage. |
| $\boxed{\%}$ | 42 . 00 | Calculates the amount. |

If the base number is already in the display as a result of a previous calculation, you should not press $\boxed{\text{ENTER}}$ before keying in the percentage — just as in a chain arithmetic calculation.

32 Section 2: Percentage and Calendar Functions

Percentages in ALG Mode

In ALG mode, to find the amount corresponding to a percentage of a number:

1. Key in the base number.
2. Press $\boxed{\times}$.
3. Key in the percentage.
4. Press $\boxed{\%}$.
5. Press $\boxed{=}$.

For example, to find 14% of \$300:

Keystrokes (ALG mode)

Display

| | | |
|---|----------|--|
| $\boxed{\text{CLx}} \boxed{\text{CLx}}$ | 0 . 00 | Clears any pending operations. |
| 300 | 300 . | Keys in the base number. |
| $\boxed{\times}$ | 300 . 00 | Tells the calculator to multiply the 300 by the percentage entered next. |
| 14 | 14 . | Keys in the percentage. |
| $\boxed{\%}$ | 0 . 14 | Divides the percentage by 100. |
| $\boxed{=}$ | 42 . 00 | Calculates the amount. |

In most cases, $\boxed{\%}$ divides a number by 100. The one exception is when a plus or minus sign precedes the number. For instance, 25 $\boxed{\%}$ results in 0.25. To find 25% of 200, press: 200 $\boxed{\times}$ 25 $\boxed{\%}$ $\boxed{=}$. (Result is 50.)

Note: This is the last time the initial $\boxed{\text{CLx}} \boxed{\text{CLx}}$ will be shown in these examples. Don't forget to clear the calculator in ALG mode before beginning a new calculation.

Net Amount in RPN Mode

A net amount — that is, the base amount plus or minus the percentage amount — can be calculated easily with your hp 12c platinum, since the calculator holds the base amount inside after you calculate a percentage amount. To calculate a net amount, simply calculate the percentage amount, then press $\boxed{+}$ or $\boxed{-}$.

Example: You're buying a new car that lists for \$23,250. The dealer offers you a discount of 8%, and the sales tax is 6%. Find the amount the dealer is charging you, then find the total cost to you, including tax.

| Keystrokes (RPN mode) | Display | |
|------------------------------|-----------|---|
| 23250 $\boxed{\text{ENTER}}$ | 23,250.00 | Keys in the base amount and separates it from the percentage. |
| 8 $\boxed{\%}$ | 1,860.00 | Amount of discount. |
| $\boxed{-}$ | 21,390.00 | Base amount less discount. |
| 6 $\boxed{\%}$ | 1,283.40 | Amount of tax (on \$21,390). |
| $\boxed{+}$ | 22,673.40 | Total cost: base amount less discount plus tax. |

Net Amount in ALG Mode

In ALG mode, you can calculate a net amount all in one calculation:

For example, to decrease 200 by 25%, just enter 200 $\boxed{-}$ 25 $\boxed{\%}$ $\boxed{=}$. (Result is 150.)

Example: You borrow \$1,250 from a relative, and agree to repay the loan in a year with 7% simple interest. How much money will you owe?

| Keystrokes (ALG mode) | Display | |
|---------------------------------|----------|---|
| 1250 $\boxed{+}$ 7 $\boxed{\%}$ | 87.50 | Interest on the loan is \$87.50. |
| $\boxed{=}$ | 1,337.50 | You owe this amount at the end of one year. |

Example: You're buying a new car that lists for \$23,250. The dealer offers you a discount of 8%, and the sales tax is 6%. Find the amount the dealer is charging you, then find the total cost to you, including tax.

| Keystrokes (ALG mode) | Display | |
|--------------------------|-----------|---|
| 23250 $\boxed{-}$ | 23,250.00 | Keys in the base amount and prepares to subtract the discount percentage. |

34 Section 2: Percentage and Calendar Functions

Keystrokes (ALG mode)

Display

| | | |
|-------|-----------|---|
| 8 [%] | 1,860.00 | Amount of discount. |
| + | 21,390.00 | Base amount less discount. |
| 6 [%] | 1,283.40 | Amount of tax (on \$21,390). |
| = | 22,673.40 | Total cost: base amount less discount plus tax. |

Percent Difference

In RPN or ALG mode, to find the percent difference between two numbers:

1. Key in the base number.
2. Press **ENTER** to separate the other number from the base number.
3. Key in the other number.
4. Press **Δ%**.

If the other number is greater than the base number, the percent difference will be positive. If the other number is less than the base number, the percent difference will be negative. Therefore, a positive answer indicates an increase, while a negative answer indicates a decrease.

If you are calculating a percent difference over time, the base number is typically the amount occurring first.

Example: Yesterday your stock fell from \$58.50 to \$53.25 per share. What is the percent change? (Note that the **ENTER** key is the same as the **=** key in ALG mode.)

Keystrokes

Display

| | | |
|-------------------|-------|---|
| 58.5 ENTER | 58.50 | Keys in the base number and separates it from the other number. |
| 53.25 | 53.25 | Keys in the other number. |
| Δ% | -8.97 | Nearly a 9% decrease. |

The **Δ%** key can be used for calculations of the percent difference between a wholesale cost and a retail cost. If the base number entered is the wholesale cost, the percent difference is called the *markup*; if the base number entered is the retail cost, the percent difference is called the *margin*. Examples of markup and margin calculations are included in the *hp 12c platinum Solutions Handbook*.

Percent of Total in RPN Mode

In RPN mode, to calculate what percentage one number is of another:

1. Calculate the total amount by adding the individual amounts, just as in a chain arithmetic calculation.
2. Key in the number whose percentage equivalent you wish to find.
3. Press $\boxed{\%T}$.

Example: Last month, your company posted sales of \$3.92 million in the U.S., \$2.36 million in Europe, and \$1.67 million in the rest of the world. What percentage of the total sales occurred in Europe?

| Keystrokes (RPN mode) | Display | |
|----------------------------------|----------------|--|
| 3.92 $\boxed{\text{ENTER}}$ | 3 . 92 | Keys in the first number and separates it from the second. |
| 2.36 $\boxed{+}$ | 6 . 28 | Adds the second number. |
| 1.67 $\boxed{+}$ | 7 . 95 | Adds the third number to get the total. |
| 2.36 | 2 . 36 | Keys in 2.36 to find what percentage it is of the number in the display. |
| $\boxed{\%T}$ | 29 . 69 | Europe had nearly 30% of the total sales. |

In RPN mode, the hp 12c platinum holds the total amount inside after a percent of total is calculated. Therefore, to calculate what percentage *another* amount is of the total:

1. Clear the display by pressing $\boxed{\text{CLX}}$.
2. Key in that amount.
3. Press $\boxed{\%T}$ again.

For example, to calculate what percent of the total sales in the preceding example occurred in the U.S. and what percent occurred in the rest of the world:

| Keystrokes (RPN mode) | Display | |
|---|----------------|---|
| $\boxed{\text{CLX}}$ 3.92 $\boxed{\%T}$ | 49 . 31 | The U.S. had about 49% of the total sales. |
| $\boxed{\text{CLX}}$ 1.67 $\boxed{\%T}$ | 21 . 01 | The rest of the world had about 21% of the total sales. |

36 Section 2: Percentage and Calendar Functions

To find what percentage a number is of a total, when you already know the total number:

1. Key in the total number.
2. Press **ENTER** to separate the other number from the total number.
3. Key in the number whose percentage equivalent you wish to find.
4. Press **%T**.

For example, if you already knew in the preceding example that the total sales were \$7.95 million and you wanted to find what percentage of that total occurred in Europe:

| Keystrokes (RPN mode) | Display | |
|----------------------------------|----------------|---|
| 7.95 ENTER | 7 . 95 | Keys in the total amount and separates it from the next number. |
| 2.36 | 2 . 36 | Keys in 2.36 to find what % it is of the number in the display. |
| %T | 29 . 69 | Europe had nearly 30% of the total sales. |

Percent of Total in ALG Mode

In ALG mode, to calculate what percentage one number is of another:

1. Calculate the total amount by adding the individual amounts, just as in a chain arithmetic calculation.
2. Key in the number whose percentage equivalent you wish to find.
3. Press **%T**.

Example: Last month, your company posted sales of \$3.92 million in the U.S., \$2.36 million in Europe, and \$1.67 million in the rest of the world. What percentage of the total sales occurred in Europe?

| Keystrokes (ALG mode) | Display | |
|----------------------------------|----------------|---|
| 3.92 + | 3 . 92 | Keys in the first number and separates it from the second. |
| 2.36 + | 6 . 28 | Adds the second number. |
| 1.67 = | 7 . 95 | Adds the third number to get the total. |
| 2.36 | 2 . 36 | Keys in 2.36 to find what % it is of the number in the display. |
| %T | 29 . 69 | Europe had nearly 30% of the total |

**Keystrokes
(ALG mode)****Display**

sales.

To find what percentage a number is of a total, when you already know the total number:

1. Key in the total number.
2. Press [=] to separate the other number from the total number.
3. Key in the number whose percentage equivalent you wish to find.
4. Press [%T].

For example, if you already knew in the preceding example that the total sales were \$7.95 million and you wanted to find what percentage of that total occurred in Europe:

**Keystrokes
(ALG mode)****Display**

7.95 [=]

7 . 95

Keys in the total amount and separates it from the next number.

2.36

2 . 36

Keys in 2.36 to find what percentage it is of the number in the display.

[%T]

29 . 69

Europe had nearly 30% of the total sales.

Calendar Functions

The calendar functions provided by the hp 12c platinum — [9] [DATE] and [9] [ADYS] — can handle dates from October 15, 1582 through November 25, 4046. These calendar functions work the same in both RPN and ALG modes.

Date Format

For each of the calendar functions — and also for bond calculations ([f] [PRICE] and [f] [YTM]) — the calculator uses one of two date formats. The date format is used to interpret dates when they are keyed into the calculator as well as for displaying dates.

Month-Day-Year. To set the date format to month-day-year, press [9] [M.DY]. To key in a date with this format in effect:

1. Key in the one or two digits of the month.
2. Press the decimal point key (□).
3. Key in the two digits of the day.
4. Key in the four digits of the year.

Dates are displayed in the same format.

For example, to key in April 7, 2004:

| Keystrokes | Display |
|------------|----------|
| 4.072004 | 4.072004 |

Day-Month-Year. To set the date format to day-month-year, press $\boxed{g} \boxed{DMY}$. To key in a date with this format in effect:

1. Key in the one or two digits of the day.
2. Press the decimal point key ($\boxed{\cdot}$).
3. Key in the two digits of the month.
4. Key in the four digits of the year.

For example, to key in 7 April, 2004:

| Keystrokes | Display |
|------------|----------|
| 7.042004 | 7.042004 |

When the date format is set to day-month-year, the **D.MY** status indicator in the display is lit. If **D.MY** is not lit, the date format is set to month-day-year.

The date format remains set to what you last specified until you change it; it is not reset each time the calculator is turned on. However, if Continuous Memory is reset, the date format is set to month-day-year.

Future or Past Dates

To determine the date and day that is a given number of days from a given date:

1. Key in the given date and press \boxed{ENTER} .
2. Key in the number of days.
3. If the other date is in the past, press \boxed{CHS} .
4. Press $\boxed{g} \boxed{DATE}$.

The answer calculated by the $\boxed{g} \boxed{DATE}$ function is displayed in a special format. The numbers of the month, day, and year (or day, month, and year) are separated by digit separators, and the digit at the right of the displayed answer indicates the day of the week: 1 for Monday through 7 for Sunday.*

* The day of the week indicated by the \boxed{DATE} function may differ from that recorded in history for dates when the Julian calendar was in use. The Julian calendar was standard in England and its colonies until September 14, 1752, when they switched to the Gregorian calendar. Other countries adopted the Gregorian calendar at various times.

Example: If you purchased a 120-day option on a piece of land on 14 May 2004, what would be the expiration date? Assume that you normally express dates in the day-month-year format.

Keystrokes

Display

`g DMY`

7 . 04

Sets date format to day-month-year. (Display shown assumes date remains from preceding example. The full date is not now displayed because the display format is set to show only two decimal places, as described in Section 5.)

14.052004`ENTER`

14 . 05

Keys in the date and separates it from the number of days to be entered.

120`g DATE`

11 , 09 , 2004 6

The expiration date is 11 September 2004, a Saturday.

When `g DATE` is executed as an instruction in a running program, the calculator pauses for about 1 second to display the result, then resumes program execution.

Number of Days Between Dates

To calculate the number of days between two given dates:

1. Key in the earlier date and press $\boxed{\text{ENTER}}$.
2. Key in the later date and press $\boxed{\text{g}} \boxed{\text{ADYS}}$.

The answer shown in the display is the actual number of days between the two dates, including leap days (the extra days occurring in leap years), if any. In addition, the hp 12c platinum also calculates the number of days between the two dates on the basis of a 30-day month. This answer is held inside the calculator; to display it, press $\boxed{\text{x}\bar{\text{y}}}$. Pressing $\boxed{\text{x}\bar{\text{y}}}$ again will return the original answer to the display.

Example: Simple interest calculations can be done using either the actual number of days or the number of days counted on the basis of a 30-day month. What would be the number of days counted each way, to be used in calculating the simple interest accruing from June 3, 2004 to October 14, 2005? Assume that you normally express dates in the month-day-year format.

Keystrokes

Display

$\boxed{\text{g}} \boxed{\text{M.DY}}$

11 . 09

Sets date format to month-day-year. (Display shown assumes date remains from preceding example.)

6.032004 $\boxed{\text{ENTER}}$

6 . 03

Keys in the earlier date and separates it from the later date.

10.142005 $\boxed{\text{g}} \boxed{\text{ADYS}}$

498 . 00

Keys in the later date. Display shows actual number of days.

$\boxed{\text{x}\bar{\text{y}}}$

491 . 00

Number of days counted on the basis of a 30-day month.

Section 3

Basic Financial Functions

The Financial Registers

In addition to the data storage registers discussed on page 27, the hp 12c platinum has five special registers in which numbers are stored for financial calculations. These registers are designated n , i , PV , PMT , and FV . The first five keys on the top row of the calculator are used to store a number from the display into the corresponding register, to calculate the corresponding financial value and store the result into the corresponding register, or to display the number stored in the corresponding register.*

Storing Numbers into the Financial Registers

To store a number into a financial register, key the number into the display, then press the corresponding key (n , i , PV , PMT , or FV).

Displaying Numbers in the Financial Registers

To display a number stored in a financial register, press RCL followed by the corresponding key.†

* Which operation is performed when one of these keys is pressed depends upon the last preceding operation performed: If a number was just stored into a financial register (using n , i , PV , PMT , FV , $9|12X$, or $9|12÷$), pressing one of these five keys calculates the corresponding value and stores it into the corresponding register; otherwise pressing one of these five keys merely stores the number from the display into the corresponding register.

† It's good practice to press the corresponding key *twice* after RCL , since often you may want to calculate a financial value right after displaying another financial value. As indicated in the preceding footnote, if you wanted to display FV and then calculate PV , for example, you should press $RCL|FV|FV|PV$. If you didn't press FV the second time, pressing PV would store FV in the PV register rather than calculating PV , and to calculate PV you would have to press PV again.

Clearing the Financial Registers

Every financial function uses numbers stored in several of the financial registers. Before beginning a new financial calculation, it is good practice to clear all of the financial registers by pressing $\boxed{f}\boxed{CLEAR}\boxed{FIN}$. Frequently, however, you may want to repeat a calculation after changing a number in only one of the financial registers. To do so, do not press $\boxed{f}\boxed{CLEAR}\boxed{FIN}$; instead, simply store the new number in the register. The numbers in the other financial registers remain unchanged.

The financial registers are also cleared when you press $\boxed{f}\boxed{CLEAR}\boxed{REG}$ and when Continuous Memory is reset (as described on page 86).

Simple Interest Calculations

The hp 12c platinum simultaneously calculates simple interest on both a 360-day basis and a 365-day basis. You can display either one, as described below. Furthermore, with the accrued interest in the display, you can calculate the total amount (principal plus accrued interest) by pressing $\boxed{+}$ in RPN mode or $\boxed{+}\boxed{\times\div y}\boxed{=}$ in ALG mode.

1. Key in or calculate the number of days, then press \boxed{n} .
2. Key in the annual interest rate, then press \boxed{i} .
3. Key in the principal amount, then press $\boxed{CHS}\boxed{PV}$.*
4. Press $\boxed{f}\boxed{INT}$ to calculate and display the interest accrued on a 360-day basis.
5. If you want to display the interest accrued on a 365-day basis, press $\boxed{R}\boxed{\downarrow}\boxed{\times\div y}$.
6. In RPN mode, press $\boxed{+}$ or in ALG mode, press $\boxed{+}\boxed{\times\div y}\boxed{=}$ to calculate the total of the principal and the accrued interest shown in the display.

The quantities n , i , and PV can be entered in any order.

* Pressing the \boxed{PV} key stores the principal amount in the PV register, which then contains the *present value* of the amount on which interest will accrue. The \boxed{CHS} key is pressed first to change the sign of the principal amount before storing it in the PV register. This is required by the cash flow sign convention (see page 46), which is applicable primarily to compound interest calculations.

Example 1: Your good friend needs a loan to start his latest enterprise and has requested that you lend him \$450 for 60 days. You lend him the money at 7% simple interest, to be calculated on a 360-day basis. What is the amount of accrued interest he will owe you in 60 days, and what is the total amount owed?

| Keystrokes (RPN mode) | Display | |
|----------------------------------|----------------|--|
| 60 \boxed{n} | 60 . 00 | Stores the number of days. |
| 7 \boxed{i} | 7 . 00 | Stores the annual interest rate. |
| 450 \boxed{CHS} \boxed{PV} | -450 . 00 | Stores the principal. |
| \boxed{f} \boxed{INT} | 5 . 25 | Accrued interest, 360-day basis. |
| $\boxed{+}$ | 455 . 25 | Total amount: principal plus accrued interest. |

In ALG mode, perform the steps in the RPN listing above, except replace the last step with the step below.

| Keystrokes (ALG mode) | Display | |
|---|----------------|--|
| $\boxed{+}$ $\boxed{\times \div y}$ $\boxed{=}$ | 455 . 25 | Total amount: principal plus accrued interest. |

Example 2: Your friend agrees to the 7% interest on the loan from the preceding example, but asks that you compute it on a 365-day basis rather than a 360-day basis. What is the amount of accrued interest he will owe you in 60 days, and what is the total amount owed?

| Keystrokes (RPN mode) | Display | |
|---|----------------|--|
| 60 \boxed{n} | 60 . 00 | } If you have not altered the numbers in the <i>n</i> , <i>i</i> , and <i>PV</i> registers since the preceding example, you may skip these keystrokes. |
| 7 \boxed{i} | 7 . 00 | |
| 450 \boxed{CHS} \boxed{PV} | -450 . 00 | |
| \boxed{f} \boxed{INT} $\boxed{R\downarrow}$ $\boxed{\times \div y}$ | 5 . 18 | Accrued interest, 365-day basis. |
| $\boxed{+}$ | 455 . 18 | Total amount: principal plus accrued interest. |

In ALG mode, perform the steps in the RPN listing above, except replace the last step with the step below.

| Keystrokes (ALG mode) | Display | |
|---|----------------|--|
| $\boxed{+}$ $\boxed{\times \div y}$ $\boxed{=}$ | 455 . 18 | Total amount: principal plus accrued interest. |

Financial Calculations and the Cash Flow Diagram

The concepts and examples presented in this section are representative of a wide range of financial calculations. If your specific problem does not appear to be illustrated in the pages that follow, *don't* assume that the calculator is not capable of solving it. Every financial calculation involves certain basic elements; but the terminology used to refer to these elements typically differs among the various segments of the business and financial communities. All you need to do is identify the basic elements in your problem, and then structure the problem so that it will be readily apparent what quantities you need to tell the calculator and what quantity you want to solve for.

An invaluable aid for using your calculator in a financial calculation is the *cash flow diagram*. This is simply a pictorial representation of the timing and direction of financial transactions, labeled in terms that correspond to keys on the calculator.

The diagram begins with a horizontal line, called a *time line*. It represents the duration of a financial problem, and is divided into compounding periods. For example, a financial problem that transpires over 6 months with monthly compounding would be diagrammed like this:



The exchange of money in a problem is depicted by vertical arrows. Money you receive is represented by an arrow pointing up from the point in the time line when the transaction occurs; money you pay out is represented by an arrow pointing down.

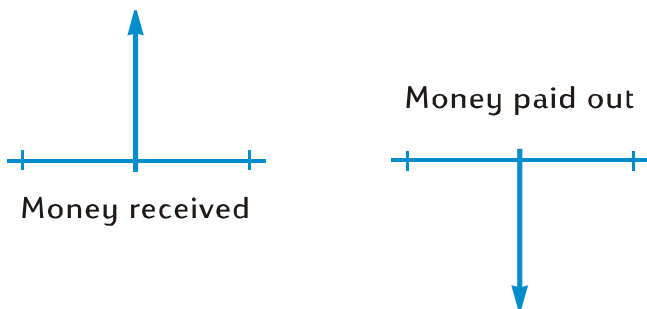

Suppose you deposited (paid out) \$1,000 into an account that pays 6% annual interest and is compounded monthly, and you subsequently deposited an additional \$50 at the end of each month for the next 2 years. The cash flow diagram describing the problem would look like this:

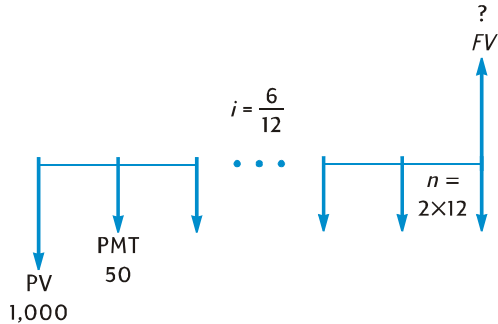

The arrow pointing up at the right of the diagram indicates that money is received at the end of the transaction. Every completed cash flow diagram must include at least one cash flow in each direction. Note that cash flows corresponding to the accrual of interest are *not* represented by arrows in the cash flow diagram.

The quantities in the problem that correspond to the first five keys on the top row of the keyboard are now readily apparent from the cash flow diagram.

- n is the number of compounding periods. This quantity can be expressed in years, months, days, or any other time unit, as long as the interest rate is expressed in terms of the same basic compounding period. In the problem illustrated in the cash flow diagram above, $n = 2 \times 12$.

The form in which n is entered determines whether or not the calculator performs financial calculations in Odd-Period mode (as described on pages 63 through 67). If n is a *noninteger* (that is, there is at least one nonzero digit to the right of the decimal point), calculations of i , PV , PMT , and FV are performed in Odd-Period mode.

- i is the interest rate *per compounding period*. The interest rate shown in the cash flow diagram and entered into the calculator is determined by dividing the annual interest rate by the number of compounding periods. In the problem illustrated above, $i = 6\% \div 12$.
- PV — the *present value* — is the initial cash flow or the present value of a series of future cash flows. In the problem illustrated above, PV is the \$1,000 initial deposit.
- PMT is the *period payment*. In the problem illustrated above PMT is the \$50 deposited each month. When all payments are equal, they are referred to as *annuities*. (Problems involving equal payments are described in this section under Compound Interest Calculations; problems involving unequal payments can be handled as described in under Discounted Cash Flow Analysis: NPV and IRR. Procedures for calculating the balance in a savings account after a series of *irregular* and/or *unequal* deposits are included in the *hp 12c platinum Solutions Handbook*.)

46 Section 3: Basic Financial Functions

- *FV* — the *future value* — is the final cash flow or the compounded value of a series of prior cash flows. In the particular problem illustrated above, *FV* is unknown (but can be calculated).

Solving the problem is now basically a matter of keying in the quantities identified in the cash flow diagram using the corresponding keys, and then calculating the unknown quantity by pressing the corresponding key. In the particular problem illustrated in the cash flow diagram above, *FV* is the unknown quantity; but in other problems, as we shall see later, *n*, *i*, *PV*, or *PMT* could be the unknown quantity. Likewise, in the particular problem illustrated above there are four known quantities that must be entered into the calculator before solving for the unknown quantity; but in other problems only three quantities may be known — which must always include *n* or *i*.

The Cash Flow Sign Convention

When entering the *PV*, *PMT*, and *FV* cash flows, the quantities must be keyed into the calculator with the proper sign, + (plus) or – (minus), in accordance with ...

The Cash Flow Sign Convention: Money received (arrow pointing up) is entered or displayed as a positive value (+). Money paid out (arrow pointing down) is entered or displayed as a negative value (–).

The Payment Mode

One more bit of information must be specified before you can solve a problem involving periodic payments. Such payments can be made either at the beginning of a compounding period (payments in advance, or annuities due) or at the end of the period (payments in arrears, or ordinary annuities). Calculations involving payments in advance yield different results than calculations involving payments in arrears. Illustrated below are portions of cash flow diagrams showing payments in advance (Begin) and payments in arrears (End). In the problem illustrated in the cash flow diagram above, payments are made in arrears.



Regardless of whether payments are made in advance or in arrears, the number of payments must be the same as the number of compounding periods.

To specify the payment mode:

- Press if payments are made at the beginning of the compounding periods.
- Press if payments are made at the end of the compounding periods.

The **BEGIN** status indicator is lit when the payment mode is set to Begin. If **BEGIN** is not lit, the payment mode is set to End.

The payment mode remains set to what you last specified until you change it; it is not reset each time the calculator is turned on. However, if Continuous Memory is reset, the payment mode will be set to End.

Generalized Cash Flow Diagrams

Examples of various kinds of financial calculations, together with the applicable cash flow diagrams, appear under Compound Interest Calculations later in this section. If your particular problem does not match any of those shown, you can solve it nevertheless by first drawing a cash flow diagram, then keying the quantities identified in the diagram into the corresponding registers. *Remember always to observe the sign convention when keying in PV, PMT, and FV.*

The terminology used for describing financial problems varies among the different segments of the business and financial communities. Nevertheless, most problems involving compound interest can be solved by drawing a cash flow diagram in one of the following basic forms. Listed below each form are some of the problems to which that diagram applies.

48 Section 3: Basic Financial Functions

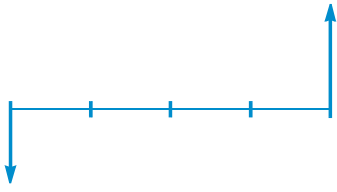

Compound Growth
Savings Account
Appreciation

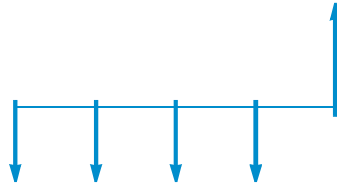

Savings Plan
Pension Fund
Annuity Due

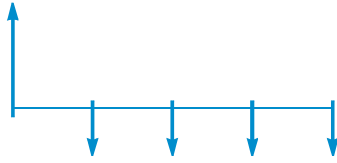

Mortgage
Direct Reduction (Installment) Loan
Amortization
Ordinary Annuity

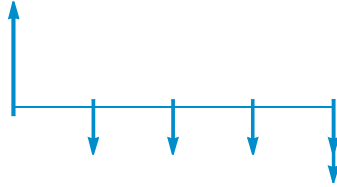

Mortgage With Balloon
Amortization
Ordinary Annuity

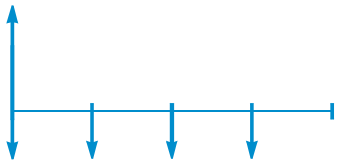

Lease
Amortization
Annuity Due

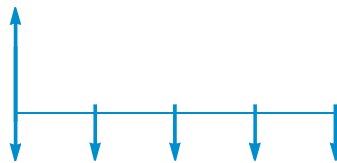

Lease With Buyback (Residual)
Amortization
Annuity Due

Compound Interest Calculations

Specifying the Number of Compounding Periods and the Periodic Interest Rate

Interest rates are usually quoted at the *annual rate* (also called the *nominal rate*): that is, the interest rate per year. However, in compound interest problems, the interest rate entered into i must always be expressed in terms of the basic compounding period, which may be years, months, days, or any other time unit. For example, if a problem involves 6% annual interest compounded quarterly for 5 years, n — the number of quarters — would be $5 \times 4 = 20$ and i — the interest rate per quarter — would be $6\% \div 4 = 1.5\%$. If the interest were instead compounded monthly, n would be $5 \times 12 = 60$ and i would be $6\% \div 12 = 0.5\%$.

If you use the calculator to multiply the number of years by the number of compounding periods per year, pressing \boxed{n} then stores the result into n . The same is true for i . Values of n and i are calculated and stored like this in Example 2 on page 60.

If interest is compounded monthly, you can use a shortcut provided on the calculator to calculate and store n and i :

- To calculate and store n , key the number of years into the display, then press $\boxed{9} \boxed{12} \times$.
- To calculate and store i , key the annual rate into the display, then press $\boxed{9} \boxed{12} \div$.

Note that these keys not only multiply or divide the displayed number by 12; they also automatically store the result in the corresponding register, so you need not press the \boxed{n} or \boxed{i} key next. The $\boxed{9} \boxed{12} \times$ and $\boxed{9} \boxed{12} \div$ keys are used in Example 1 on page 59.

Calculating the Number of Payments or Compounding Periods

1. Press $\boxed{f} \boxed{\text{CLEAR}} \boxed{\text{FIN}}$ to clear the financial registers.
2. Enter the periodic interest rate, using \boxed{i} or $\boxed{9} \boxed{12} \div$.
3. Enter at least two of the following values:
 - Present value, using $\boxed{\text{PV}}$.
 - Payment amount, using $\boxed{\text{PMT}}$.
 - Future value, using $\boxed{\text{FV}}$.
4. If a PMT was entered, press $\boxed{9} \boxed{\text{BEG}}$ or $\boxed{9} \boxed{\text{END}}$ to set the payment mode.
5. Press \boxed{n} to calculate the number of payments or periods.

Note: Remember to observe the cash flow sign convention.

50 Section 3: Basic Financial Functions

If the answer calculated is not an integer (that is, there would be nonzero digits to the right of the decimal point), the calculator rounds the answer up to the next higher integer before storing it in the n register and displaying it.* For example, if n were calculated as 318.15, 319.00 would be the displayed answer.

n is rounded up by the calculator to show the *total* number of payments needed: $n-1$ equal, full payments, and one final, smaller payment. The calculator does not automatically adjust the values in the other financial registers to reflect n equal payments; rather, it allows you to choose which, if any, of the values to adjust.† Therefore, if you want to know the value of the final payment (with which you can calculate a balloon payment) or desire to know the payment value for n equal payments, you will need to press one of the other financial keys, as shown in the following two examples.

Example 1: You're planning to build a log cabin on your vacation property. Your rich uncle offers you a \$35,000 loan at 10.5% interest. If you make \$325 payments at the end of each month, how many payments will be required to pay off the loan, and how many years will this take?

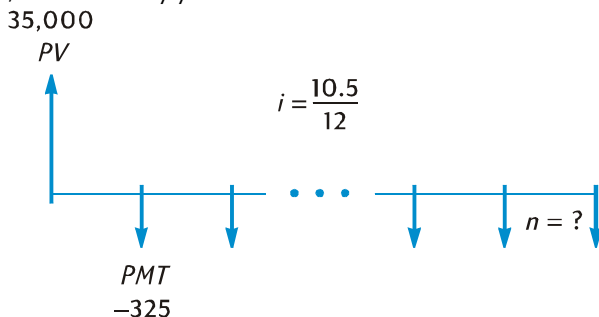

Keystrokes (RPN mode)

Display

| | | |
|--|---------------|---|
| \boxed{f} CLEAR \boxed{FIN} | | |
| 10.5 \boxed{g} $\boxed{12}$ $\boxed{\div}$ | 0 . 88 | Calculates and stores i . |
| 35000 \boxed{PV} | 35 , 000 . 00 | Stores PV . |
| 325 \boxed{CHS} \boxed{PMT} | -325 . 00 | Stores PMT (with minus sign for cash paid out). |
| \boxed{g} \boxed{END} | -325 . 00 | Sets the payment mode to End. |

* The calculator will round n down to the next lower integer if the fractional portion of n is less than 0.005.

† After calculating n , pressing \boxed{i} , \boxed{PV} , \boxed{PMT} , or \boxed{FV} will recalculate the value in the corresponding financial register.

**Keystrokes
(RPN mode)**

n

Display

328.00

Number of payments required.

12 \div

27.33

Twenty-seven years and four months.

In ALG mode, perform the RPN steps but replace the last step with the step below.

**Keystrokes
(ALG mode)** \div 12 =**Display**

27.33

Twenty-seven years and four months.

Because the calculator rounds the calculated value of n up to the next higher integer, in the preceding example it is likely that — while 328 payments will be required to pay off the loan — only 327 *full* payments of \$325 will be required, the next and final payment being less than \$325. You can calculate the final, fractional, 328th payment as follows:

**Keystrokes
(RPN mode)**

328 n

Display

328.00

Stores total number of payments.*

FV

181.89

Calculates *FV* — which equals the overpayment if 328 full payments were made.

RCL PMT

-325.00

Recalls payment amount.

+

-143.11

Final, fractional payment.

**Keystrokes
(ALG mode)**

328 n

Display

328.00

Stores total number of payments.*

FV

181.89

Calculates *FV* — which equals the overpayment if 328 full payments were made.

* You could skip this step, since 328 is already stored in the n register. If you do so, however, you will need to press FV twice in the next step (for the reason discussed in the first footnote on page 41; you would not have to press FV twice if you had not pressed 12 \div in RPN mode or \div 12 = in ALG mode after n in the example above.) We choose to show this and the following example in a parallel format so that the procedure is easy to remember: the number you key is the number of the final payment — either the fractional payment or the balloon payment — whose amount is to be calculated.

**Keystrokes
(ALG mode)**

[+] [RCL] [PMT]

Display

-325.00

Recalls payment amount.

[=]

-143.11

Final, fractional payment.

Alternatively, you could make the fractional payment together with the 327th payment. (Doing so will result in a somewhat smaller total of all payments, since you will not have to pay interest during the 328th payment period.) You can calculate this final, larger, 327th payment (essentially a balloon payment) as follows:

**Keystrokes
(RPN mode)**

327 [n]

Display

327.00

Stores number of *full payments*.

[FV]

-141.87

Calculates *FV* — which is the balance remaining after 327 full payments.

[RCL] [PMT]

-325.00

Recalls payment amount.

[+]

-466.87

Final, balloon payment.

**Keystrokes
(ALG mode)**

327 [n]

Display

327.00

Stores number of *full payments*.

[FV]

-141.87

Calculates *FV* — which is the balance remaining after 327 full payments.

[+] [RCL] [PMT]

-325.00

Recalls payment amount.

[=]

-466.87

Final, balloon payment.

Instead of having a fractional (or balloon) payment at the end of the loan, you might wish to make 327 or 328 *equal* payments. Refer to “Calculating the Payment Amount” on page 59 for a complete description of this procedure.

Example 2: You're opening a savings account today (the middle of the month) with a \$775 deposit. The account pays 6.25% interest compounded semimonthly. If you make semimonthly deposits of \$50 beginning next month, how long will it take for your account to reach \$4,000?

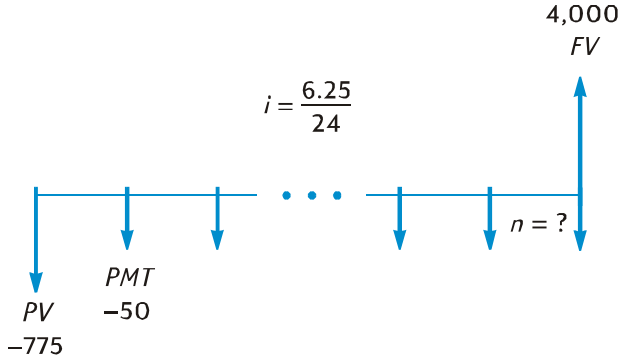

Keystrokes (RPN mode)

f CLEAR FIN
 6.25 ENTER 24 ÷ i
 775 CHS PV
 50 CHS PMT
 4000 FV
 9 END
 n
 2 ÷

Display

0.26 Calculates and stores *i*.
 -775.00 Stores *PV* (with minus sign for cash paid out).
 -50.00 Stores *PMT* (with minus sign for cash paid out).
 4,000.00 Stores *FV*.
 4,000.00 Sets the payment mode to End.
 58.00 Number of semimonthly deposits.
 29.00 Number of months.

Keystrokes (ALG mode)

f CLEAR FIN
 6.25 ÷ 24 i
 775 CHS PV
 50 CHS PMT
 4000 FV

Display

0.26 Calculates and stores *i*.
 -775.00 Stores *PV* (with minus sign for cash paid out).
 -50.00 Stores *PMT* (with minus sign for cash paid out).
 4,000.00 Stores *FV*.

**Keystrokes
(ALG mode)****Display**

| | | |
|------------------------------------|----------|---------------------------------|
| $\boxed{g} \boxed{END}$ | 4,000.00 | Sets the payment mode to End. |
| \boxed{n} | 58.00 | Number of semimonthly deposits. |
| $\boxed{\div} \boxed{2} \boxed{=}$ | 29.00 | Number of months. |

As in Example 1, it is likely that only 57 *full* deposits will be required, the next and final deposit being less than \$50. You can calculate this final, fractional, 58th deposit as in Example 1, except that for this example you must subtract the original *FV*. (In Example 1, the original *FV* was zero.) The procedure is as follows:

**Keystrokes
(RPN mode)****Display**

| | | |
|---------------------------|----------|--|
| $\boxed{FV} \boxed{FV}$ | 4,027.27 | Calculates <i>FV</i> – which equals the balance in the account if 58 full deposits were made.* |
| $\boxed{RCL} \boxed{PMT}$ | -50.00 | Recalls amount of deposits. |
| $\boxed{+}$ | 3,977.27 | Calculates the balance in the account if 57 full deposits were made and interest accrued during the 58 th month.† |
| 4000 $\boxed{-}$ | -22.73 | Calculates final, fractional, 58 th deposit required to reach \$4,000. |

**Keystrokes
(ALG mode)****Display**

| | | |
|-------------------------------------|----------|--|
| $\boxed{FV} \boxed{FV}$ | 4,027.27 | Calculates <i>FV</i> – which equals the balance in the account if 58 full deposits were made.* |
| $\boxed{+} \boxed{RCL} \boxed{PMT}$ | -50.00 | Recalls amount of deposits. |
| $\boxed{-}$ | 3,977.27 | Calculates the balance in the account if 57 full deposits were made and interest accrued during the 58 th month.† |

* In this example, \boxed{FV} must be pressed twice, since the preceding key pressed was $\boxed{+}$ in RPN mode and $\boxed{=}$ in ALG mode. If we had stored the number of deposits in *n* (as we did following Example 1), we would have to press \boxed{FV} only once here, since the preceding key pressed would have been \boxed{n} (as it was following Example 1). Remember that it is not necessary to store the number of payments in *n* before calculating the amount of the final, *fractional* payment. (Refer to the preceding footnote.)

† You might think that we could calculate the balance in the account after 57 *full* deposits were made simply by storing that number in *n* and then calculating *FV*, as we did using the second method following Example 1. However, this balance would *not* include the interest accrued during the 58th month.

| Keystrokes (ALG mode) | Display | |
|--------------------------|---------|---|
| 4000 [=] | -22.73 | Calculates final, fractional, 58 th deposit required to reach \$4,000. |

Calculating the Periodic and Annual Interest Rates

1. Press [f] CLEAR [FIN] to clear the financial registers.
 2. Enter the number of payments or periods, using [n] or [g] [12] [X].
 3. Enter at least two of the following values:
 - Present value, using [PV].
 - Payment amount, using [PMT].
 - Future value, using [FV].
- } **Note:** Remember to observe the cash flow sign convention.
4. If a *PMT* was entered, press [g] [BEG] or [g] [END] to set the payment mode.
 5. Press [i] to calculate the periodic interest rate.
 6. To calculate the annual interest rate in RPN mode, key in the number of periods per year, then press [X]. To calculate the annual interest rate in ALG mode, press [X], key in the number of periods per year, then press [=].

Example: What annual interest rate must be obtained to accumulate \$10,000 in 8 years on an investment of \$6,000 with quarterly compounding?

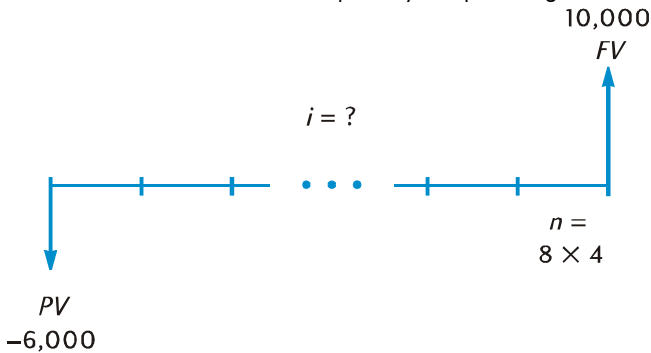

| Keystrokes (RPN mode) | Display | |
|--------------------------|-----------|---|
| [f] CLEAR [FIN] | | |
| 8 [ENTER] 4 [X] [n] | 32.00 | Calculates and stores <i>n</i> . |
| 6000 [CHS] [PV] | -6,000.00 | Stores <i>PV</i> (with minus sign for cash paid out). |
| 10000 [FV] | 10,000.00 | Stores <i>FV</i> . |

**Keystrokes
(RPN mode)**

[i]

Display

1 . 61

Periodic (quarterly) interest rate.

4[X]

6 . 44

Annual interest rate.

**Keystrokes
(ALG mode)**

[f] CLEAR [FIN]

Display

8[X] 4 [n]

32 . 00

Calculates and stores *n*.

6000 [CHS] [PV]

-6,000 . 00

Stores *PV* (with minus sign for cash paid out).

10000 [FV]

10,000 . 00

Stores *FV*.

[i]

1 . 61

Periodic (quarterly) interest rate.

[X] 4 [=]

6 . 44

Annual interest rate.

Calculating the Present Value

1. Press [f] CLEAR [FIN] to clear the financial registers.
2. Enter the number of payments or periods, using [n] or [9] [12] [X].
3. Enter the periodic interest rate, using [i] or [9] [12] [÷].
4. Enter either or both of the following:

- Payment amount, using [PMT].
- Future value, using [FV].



Note: Remember to observe the cash flow sign convention.

5. If a *PMT* was entered, press [9] [BEG] or [9] [END] to set the payment mode.
6. Press [PV] to calculate the present value.

Example 1: You're financing a new car purchase with a loan from an institution that requires 5.9% interest compounded monthly over the 4-year term of the loan. If you can make payments of \$450 at the end of each month and your down payment will be \$1,500, what is the maximum price you can pay for the car? (Assume the purchase date is one month prior to the date of the first payment.)

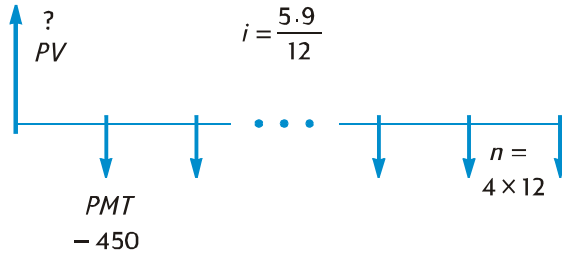

**Keystrokes
(RPN mode)**

Display

| | | |
|----------------------------------|---------------|---|
| \boxed{f} CLEAR \boxed{FIN} | | |
| 4 \boxed{g} $\boxed{12X}$ | 48 . 00 | Calculates and stores n . |
| 5.9 \boxed{g} $\boxed{12\div}$ | 0 . 49 | Calculates and stores i . |
| 450 \boxed{CHS} \boxed{PMT} | -450 . 00 | Stores PMT (with minus sign for cash paid out). |
| \boxed{g} \boxed{END} | -450 . 00 | Sets payment mode to End. |
| \boxed{PV} | 19 , 198 . 60 | Maximum amount of loan. |
| 1500 $\boxed{+}$ | 20 , 698 . 60 | Maximum purchase price. |

In ALG mode, press the keys listed for RPN mode but replace the last step above with the step below.

**Keystrokes
(ALG mode)**

Display

| | | |
|------------------------------|---------------|-------------------------|
| $\boxed{+}$ 1500 $\boxed{=}$ | 20 , 698 . 60 | Maximum purchase price. |
|------------------------------|---------------|-------------------------|

58 Section 3: Basic Financial Functions

Example 2: A development company would like to purchase a group of condominiums with an annual net cash flow of \$17,500. The expected holding period is 5 years, and the estimated selling price at that time is \$540,000. Calculate the maximum amount the company can pay for the condominiums in order to realize at least a 12% annual yield.

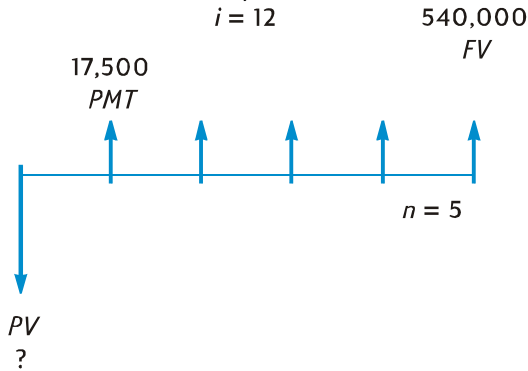

Keystrokes

5

12

17500

540000

Display

5.00

Stores *n*.

12.00

Stores *i*.

17,500.00

Stores *PMT*. Unlike in the previous problem, here *PMT* is positive since it represents cash received.

540,000.00

Stores *FV*.

540,000.00

Sets payment mode to End.

-369,494.09

The maximum purchase price to provide a 12% annual yield. *PV* is displayed with a minus sign since it represents cash paid out.

Calculating the Payment Amount

1. Press \boxed{f} CLEAR \boxed{FIN} to clear the financial registers.
 2. Enter the number of payments or periods, using \boxed{n} or \boxed{g} $\boxed{12x}$.
 3. Enter the periodic interest rate, using \boxed{i} or \boxed{g} $\boxed{12\div}$.
 4. Enter either or both of the following:
 - Present value, using \boxed{PV} .
 - Future value, using \boxed{FV} .
- Note:** Remember to observe the cash flow sign convention.
5. Press \boxed{g} \boxed{BEG} or \boxed{g} \boxed{END} to set the payment mode.
 6. Press \boxed{PMT} to calculate the payment amount.

Example 1: Calculate the payment amount on a 29-year, \$243,400 mortgage at 5.25% annual interest, compounded monthly.

243,400

PV

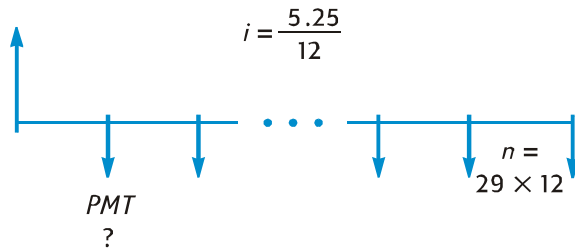

Keystrokes

\boxed{f} CLEAR \boxed{FIN}

29 \boxed{g} $\boxed{12x}$

5.25 \boxed{g} $\boxed{12\div}$

243400 \boxed{PV}

\boxed{g} \boxed{END}

\boxed{PMT}

Display

348.00

Calculates and stores n .

0.44

Calculates and stores i .

243,400.00

Stores PV .

243,400.00

Sets payment mode to End.

-1,363.29

Monthly payment (with minus sign for cash paid out).

60 Section 3: Basic Financial Functions

Example 2: Looking forward to retirement, you wish to accumulate \$60,000 after 15 years by making deposits in an account that pays 9.75% interest compounded semiannually. You open the account with a deposit of \$3,200 and intend to make semiannual deposits, beginning six months later, from your profit-sharing bonus paychecks. Calculate how much these deposits should be.

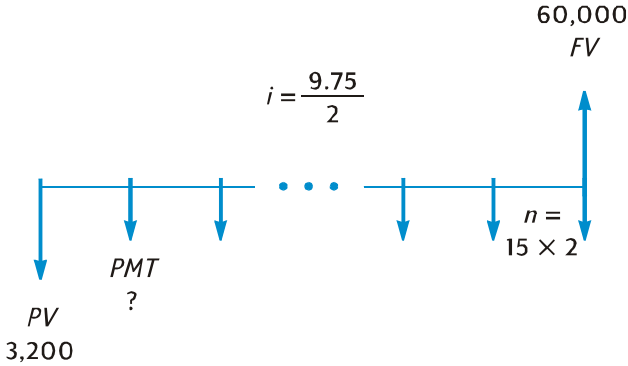

**Keystrokes
(RPN mode)**

`f` `CLEAR` `FIN`
`15` `ENTER` `2` `X` `n`
`9.75` `ENTER` `2` `÷` `i`
`3200` `CHS` `PV`
`60000` `FV`
`g` `END`
`PMT`

Display

`30.00` Calculates and stores *n*.
`4.88` Calculates and stores *i*.
`-3,200.00` Stores *PV* (with minus sign for cash paid out).
`60,000.00` Stores *FV*.
`60,000.00` Sets payment mode to End.
`-717.44` Semiannual payment (with minus sign for cash paid out).

**Keystrokes
(ALG mode)**

`f` `CLEAR` `FIN`
`15` `X` `2` `n`
`9.75` `÷` `2` `i`
`3200` `CHS` `PV`
`60000` `FV`
`g` `END`

Display

`30.00` Calculates and stores *n*.
`4.88` Calculates and stores *i*.
`-3,200.00` Stores *PV* (with minus sign for cash paid out).
`60,000.00` Stores *FV*.
`60,000.00` Sets payment mode to End.

**Keystrokes
(ALG mode)**

Display

| | | |
|-----|---------|---|
| PMT | -717.44 | Semiannual payment (with minus sign for cash paid out). |
|-----|---------|---|

Calculating the Future Value

1. Press \boxed{f} CLEAR \boxed{FIN} to clear the financial registers.
 2. Enter the number of payments or periods, using \boxed{n} or \boxed{g} $\boxed{12x}$.
 3. Enter the periodic interest rate, using \boxed{i} or \boxed{g} $\boxed{12\div}$.
 4. Enter either or both of the following:
 - Present value, using \boxed{PV} .
 - Payment amount, using \boxed{PMT} .
- } **Note:** Remember to observe the cash flow sign convention.
5. If a *PMT* was entered, press \boxed{g} \boxed{BEG} or \boxed{g} \boxed{END} to set the payment mode.
 6. Press \boxed{FV} to calculate the future value.

Example 1: In Example 1 on page 59, we calculated that the payment amount on a 29-year, \$243,400 mortgage at 5.25% annual interest compounded monthly is \$1,363.29. If the seller requests a balloon payment at the end of 5 years, what would be the amount of the balloon?

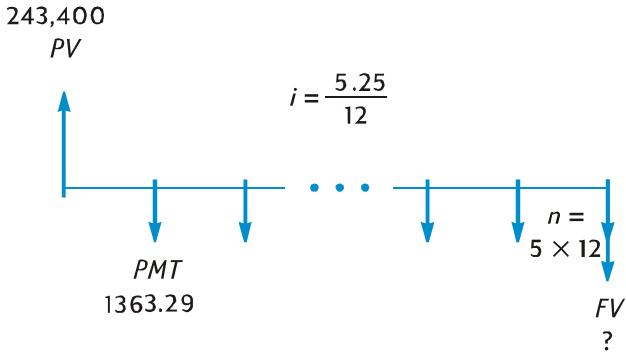

Keystrokes

Display

| | | |
|-------------------------------------|------------|--|
| \boxed{f} CLEAR \boxed{FIN} | | |
| 5 \boxed{g} $\boxed{12x}$ | 60.00 | Calculates and stores <i>n</i> . |
| 5.25 \boxed{g} $\boxed{12\div}$ | 0.44 | Calculates and stores <i>i</i> . |
| 243400 \boxed{PV} | 243,400.00 | Stores <i>PV</i> . |
| 1363.29 \boxed{CHS} \boxed{PMT} | -1,363.29 | Stores <i>PMT</i> (with minus sign for cash paid out). |

62 Section 3: Basic Financial Functions

Keystrokes

$\boxed{g} \boxed{END}$

\boxed{FV}

Display

-1,363.29 Sets payment mode to End.

-222,975.98 Amount of balloon payment.

Example 2: If you deposit \$50 a month (at the beginning of each month) into a new account that pays 6.25% annual interest compounded monthly, how much will you have in the account after 2 years?

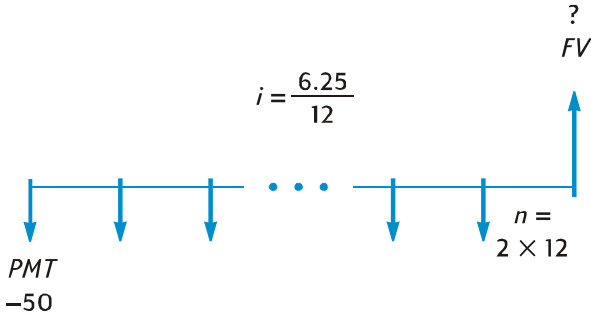

Keystrokes

$\boxed{f} \boxed{CLEAR} \boxed{FIN}$

2 $\boxed{g} \boxed{12X}$

6.25 $\boxed{g} \boxed{12\div}$

50 $\boxed{CHS} \boxed{PMT}$

$\boxed{g} \boxed{BEG}$

\boxed{FV}

Display

24.00 Calculates and stores n .

0.52 Calculates and stores i .

-50.00 Stores PMT (with minus sign for cash paid out).

-50.00 Sets payment mode to Begin.

1,281.34 Balance after 2 years.

Example 3: Property values in an unattractive area are depreciating at the rate of 2% per year. Assuming this trend continues, calculate the value in 6 years of property presently appraised at \$32,000.

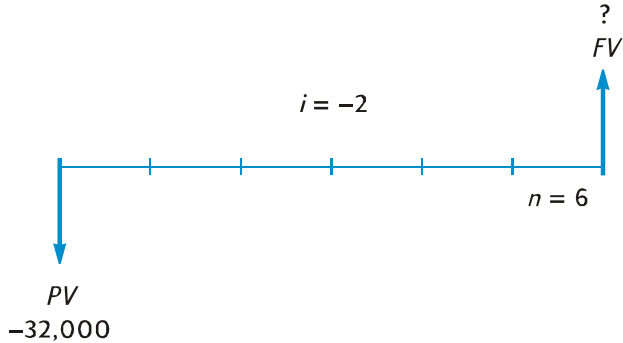

Keystrokes

Display

| | | |
|--|------------|---|
| <code>f</code> CLEAR <code>FIN</code> | | |
| <code>6</code> <code>n</code> | 6.00 | Stores <i>n</i> . |
| <code>2</code> <code>CHS</code> <code>i</code> | -2.00 | Stores <i>i</i> (with minus sign for a "negative interest rate"). |
| 32000 <code>CHS</code> <code>PV</code> | -32,000.00 | Stores <i>PV</i> (with minus sign for cash paid out). |
| <code>FV</code> | 28,346.96 | Property value after 6 years. |

Odd-Period Calculations

The cash flow diagrams and examples presented so far have dealt with financial transactions in which interest begins to accrue at the beginning of the first regular payment period. However, interest often begins to accrue prior to the beginning of the first regular payment period. The period from the date interest begins accruing to the date of the first payment, being not equal to the regular payment periods is sometimes referred to as an "odd first period". For simplicity, in using the hp 12c platinum we will always regard the first period as equal to the remaining periods, and we will refer to the *period between the date interest begins accruing and the beginning of the first payment period* as simply the "odd period" or the "odd days". (Note that the odd period is always assumed by the calculator to occur *before* the first full payment period.) The following two cash flow diagrams represent transactions including an odd period for payments in advance (Begin) and for payments in arrears (End).

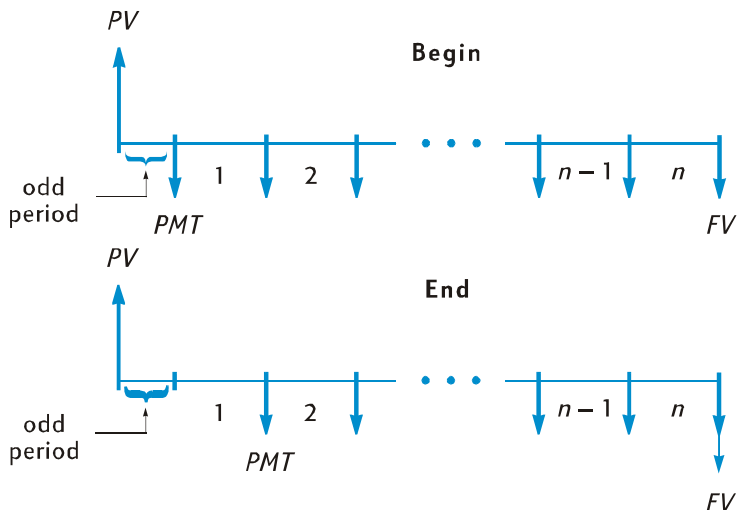

You can calculate i , PV , PMT , and FV for transactions involving an odd period simply by entering a *noninteger* n . (A noninteger is a number with at least one nonzero digit to the right of the decimal point.) This places the calculator in Odd-Period mode.* The integer part of n (the part to the left of the decimal point) specifies the number of full payment periods, and the fractional part (the part to the right of the decimal) specifies the length of the odd period as a fraction of a full period. The odd period, therefore, cannot be greater than one full period.

* Calculations of i , PMT , and FV are performed using the present value at the end of the odd period. This is equal to the number in the PV register *plus* the interest accrued during the odd period. When calculating PV in Odd-Period mode, the calculator returns a value equal to the present value at the *beginning* of the odd period and stores it in the PV register.

After calculating i , PV , PMT , or FV in Odd-Period mode, you should not try to calculate n . If you do, the calculator will switch out of Odd-Period mode and compute n without taking the odd period into account. The values in the other financial registers will correspond to the new n , but the original assumptions for the problem will be changed.

The fractional part of n can be determined using either the actual number of odd days or the number of odd days counted on the basis of a 30-day month.* The $\boxed{g} \boxed{\Delta DYS}$ function can be used to calculate the number of odd days either way. The fractional part of n is a fraction of a payment period, so the number of odd days must be divided by the number of days in a period. If interest is compounded monthly, for this number you can use either 30, $365/12$, or (if the odd period falls entirely within a single month) the actual number of days in that month. Usually, a monthly period is taken to be 30 days long.

At your option, the calculations of i , PV , PMT , and FV can be performed with either simple interest or compound interest accruing during the odd period. If the **C** status indicator in the display is not lit, simple interest is used. To specify compound interest, turn the **C** indicator on by pressing $\boxed{STO} \boxed{EEX}$.† Pressing $\boxed{STO} \boxed{EEX}$ again turns the **C** indicator off, and calculations will then be performed using simple interest for the odd period.

Example 1: A 36-month loan for \$4,500 accrues interest at a 5% annual percentage rate (APR), with the payments made at the end of each month. If interest begins accruing on this loan on February 15, 2004 (so that the first period begins on March 1, 2004), calculate the monthly payment, with the odd days counted on the basis of a 30-day month and compound interest used for the odd period.

Keystrokes (RPN mode)

Display

$\boxed{f} \boxed{CLEAR} \boxed{FIN}$

Clears financial registers.

$\boxed{g} \boxed{M.DY}$

Sets date format to month-day-year.

$\boxed{g} \boxed{END}$

Sets payment mode to End.

$\boxed{STO} \boxed{EEX}$

Turns on the **C** indicator in the display, so that compound interest will be used for the odd period.

2.152004 \boxed{ENTER}

2.15

Keys in the date interest begins accruing and separates it from the next date entered.

3.012004

3.012004

Keys in the date of the beginning of the first period.

* The two methods of counting odd days will yield slightly different answers. If you are calculating i to determine the annual percentage rate (APR) for an odd-period transaction, the lower APR will result if the calculation uses the greater number of odd days determined using the two methods.

† $\boxed{STO} \boxed{EEX}$ is not programmable.

**Keystrokes
(RPN mode)**g Δ DYS $\times \div$ y30 \div 36 $+$ n5 g Δ 12 \div

4500 PV

PMT

Display

15.00

16.00

0.53

36.53

0.42

4,500.00

-135.17

Actual number of odd days.

Number of odd days counted on the basis of a 30-day month.

Divides by the length of a monthly period to get the fractional part of n .Adds the fractional part of n to the number of complete payment periods, then stores the result in n .Calculates and stores i .Stores PV .

Monthly payment.

**Keystrokes
(ALG mode)**

STO EEX

2.152004 \equiv

3.012004

g Δ DYS $\times \div$ y \div 30 $+$

36 n

5 g Δ 12 \div

4500 PV

PMT

Display

2.15

3.012004

15.00

16.00

0.53

36.53

0.42

4,500.00

-135.17

Turns on the **C** indicator in the display, so that compound interest will be used for the odd period.

Keys in the date interest begins accruing and separates it from the next date entered.

Keys in the date of the beginning of the first period.

Actual number of odd days.

Number of odd days counted on the basis of a 30-day month.

Divides by the length of a monthly period to get the fractional part of n .Adds the fractional part of n to the number of complete payment periods, then stores the result in n .Calculates and stores i .Stores PV .

Monthly payment.

Example 2: A 42-month loan of \$3,950 for a used car began accruing interest on July 19, 2004, so that the first period began on August 1, 2004. Payments of \$120 are made at the end of each month. Calculate the annual percentage rate (APR), using the actual number of odd days and simple interest for the odd period.

**Keystrokes
(RPN mode)**

f CLEAR FIN

STO EEX

7.192004 ENTER

8.012004

g ADYS

30 ÷

42 + n

3950 PV

120 CHS PMT

i

12 X

Display

Clears financial registers.

Turns off the **C** indicator in the display, so that simple interest will be used for the odd period.

7.19

Keys in the date interest begins accruing and separates it from the next date entered.

8.012004

Keys in the date of the beginning of the first period.

13.00

Actual number of odd days.

0.43

Divides by the length of a monthly period to get the fractional part of n .

42.43

Adds the fractional part of n to the number of complete payment periods, then stores the result in n .

3,950.00

Stores PV .

-120.00

Stores PMT (with minus sign for cash paid out).

1.16

Periodic (monthly) interest rate.

13.95

Annual percentage rate (APR).

**Keystrokes
(ALG mode)**

f CLEAR FIN

STO EEX

7.192004 =

Display

Clears financial registers.

Turns off the **C** indicator in the display, so that simple interest will be used for the odd period.

7.19

Keys in the date interest begins accruing and separates it from the next date entered.

**Keystrokes
(ALG mode)****Display**

| | | |
|---------------------------------------|--------------|--|
| 8.012004 | 8 . 012004 | Keys in the date of the beginning of the first period. |
| $\boxed{g} \boxed{\Delta DYS}$ | 13 . 00 | Actual number of odd days. |
| $\boxed{\div} \boxed{30} \boxed{+}$ | 0 . 43 | Divides by the length of a monthly period to get the fractional part of n . |
| 42 \boxed{n} | 42 . 43 | Adds the fractional part of n to the number of complete payment periods, then stores the result in n . |
| 3950 \boxed{PV} | 3 , 950 . 00 | Stores PV . |
| 120 $\boxed{CHS} \boxed{PMT}$ | -120 . 00 | Stores PMT (with minus sign for cash paid out). |
| \boxed{i} | 1 . 16 | Periodic (monthly) interest rate. |
| $\boxed{\times} \boxed{12} \boxed{=}$ | 13 . 95 | Annual percentage rate (APR). |

Before leaving this Odd-Period mode example, you may now press $\boxed{STO} \boxed{EEX}$ to turn the **C** annunciator off, if needed. Note that when the calculator is not in Odd-Period mode, the status of the **C** annunciator actually has no effect on calculator operation. You will find another use of Odd-Period mode and $\boxed{STO} \boxed{EEX}$ in Section 16 of this manual, where the **C** must be set before the two Bond programs will work correctly.

Amortization

The hp 12c platinum enables you to calculate the amounts applied toward principal and toward interest from a single loan payment or from several payments, and also tells you the remaining balance of the loan after the payments are made.*

To obtain an amortization schedule:

1. Press \boxed{f} CLEAR \boxed{FIN} to clear the financial registers.
2. Enter the periodic interest rate, using \boxed{i} or \boxed{g} $\boxed{12\div}$.
3. Enter the amount of the loan (the principal), using \boxed{PV} .
4. Key in the periodic payment, then press \boxed{CHS} \boxed{PMT} (the sign of *PMT* must be negative, in accordance with the cash flow sign convention).
5. Press \boxed{g} \boxed{BEG} or (for most direct reduction loans) \boxed{g} \boxed{END} to set the payment mode.
6. Key in the number of payments to be amortized.
7. Press \boxed{f} \boxed{AMORT} to display the amount from those payments applied toward interest.
8. Press $\boxed{X\div Y}$ to display the amount from those payments applied toward the principal.
9. To display the number of payments just amortized, press \boxed{R} \boxed{R} .
10. To display the remaining balance of the loan, press \boxed{RCL} \boxed{PV} .
11. To display the *total* number of payments amortized, press \boxed{RCL} \boxed{n} .

Example: For a house you're about to buy, you can obtain a 25-year mortgage for \$250,000 at 5.25% annual interest. This requires payments of \$1,498.12 (at the end of each month). Find the amounts that would be applied to interest and to the principal from the first year's payments.

| Keystrokes | Display |
|-----------------------------------|---------------------------------|
| \boxed{f} CLEAR \boxed{FIN} | |
| 5.25 \boxed{g} $\boxed{12\div}$ | 0.44 Enters <i>i</i> . |
| 250000 \boxed{PV} | 250,000.00 Enters <i>PV</i> . |

* All amounts calculated when \boxed{f} \boxed{AMORT} is pressed are automatically rounded to the number of decimal places specified by the display format. (The display format is described in Section 5.) This rounding affects the number *inside* the calculator as well as how the number appears in the display. The amounts calculated on your hp 12c platinum may differ from those on the statements of lending institutions by a few cents, since different rounding techniques are sometimes used. To calculate answers rounded to a different number of decimal places, press \boxed{f} followed by the number of decimal places desired before you press \boxed{f} \boxed{AMORT} .

70 Section 3: Basic Financial Functions

Keystrokes

1498.12 **[CHS]** **[PMT]**

[g] **[END]**

12 **[f]** **[AMORT]**

[x \geq y]

[RCL] **[PV]**

[RCL] **[n]**

Display

-1,498.12 Enters PMT (with minus sign for cash paid out).

-1,498.12 Sets payment mode to End.

-13,006.53 Portion of first year's payments (12 months) applied to interest.

-4,970.91 Portion of first year's payments applied to principal.

245,029.09 Balance remaining after 1 year.

12.00 Total number of payments amortized.

The number of payments keyed in just before **[f]** **[AMORT]** is pressed is taken to be the payments following any that have already been amortized. Thus, if you now press 12 **[f]** **[AMORT]**, your hp 12c platinum will calculate the amounts applied to interest and to the principal from the second year's payments (that is, the second 12 months):

Keystrokes

12 **[f]** **[AMORT]**

[x \geq y]

[R] **[R]**

[RCL] **[PV]**

[RCL] **[n]**

Display

-12,739.18 Portion of second year's payments applied to interest.

-5,238.26 Portion of second year's payments applied to principal.

12.00 Number of payments just amortized.

239,790.83 Balance remaining after 2 years.

24.00 Total number of payments amortized.

Pressing **[RCL]** **[PV]** or **[RCL]** **[n]** displays the number in the PV or n register. When you did so after each of the last two calculations, you may have noticed that PV and n had been changed from their original values. The calculator does this so that you can easily check the remaining balance and the total number of payments amortized. But because of this, if you want to generate a new amortization schedule from the beginning, you must reset PV to its original value and reset n to 0.

For example, suppose you now wanted to generate an amortization schedule for each of the first two months:

Keystrokes

250000 **[PV]**

0 **[n]**

Display

250,000.00 Resets PV to original value.

0.00 Resets n to zero.

Keystrokes1 \boxed{f} \boxed{AMORT} $\boxed{X \rightleftharpoons Y}$ 1 \boxed{f} \boxed{AMORT} $\boxed{X \rightleftharpoons Y}$ \boxed{RCL} \boxed{n} **Display**

-1,093.75 Portion of first payment applied to interest.

-404.37 Portion of first payment applied to principal.

-1,091.98 Portion of second payment applied to interest.

-406.14 Portion of second payment applied to principal.

2.00 Total number of payments amortized.

If you want to generate an amortization schedule but do not already know the monthly payment:

1. Calculate *PMT* as described on page 59.
2. Press $0 \boxed{n}$ to reset *n* to zero.
3. Proceed with the amortization procedure listed on page 69 beginning with step 6.

Example: Suppose you obtained a 30-year mortgage instead of a 25-year mortgage for the same principal (\$250,000) and at the same interest rate (5.25%) as in the preceding example. Calculate the monthly payment, then calculate the amounts applied to interest and to the principal from the first month's payment. Since the interest rate is not being changed, do not press \boxed{f} \boxed{CLEAR} \boxed{FIN} ; to calculate *PMT*, just enter the new value for *n*, reset *PV*, then press \boxed{PMT} .

Keystrokes30 \boxed{g} $\boxed{12X}$ 250000 \boxed{PV} \boxed{PMT} 0 \boxed{n} 1 \boxed{f} \boxed{AMORT} $\boxed{X \rightleftharpoons Y}$ \boxed{RCL} \boxed{PV} **Display**360.00 Enters *n*.250,000.00 Enters *PV*.

-1,380.51 Monthly payment.

0.00 Resets *n* to zero.

-1,093.75 Portion of first payment applied to interest.

-286.76 Portion of first payment applied to principal.

249,713.24 Remaining balance.

Section 4

Additional Financial Functions

Discounted Cash Flow Analysis: NPV and IRR

The hp 12c platinum provides functions for the two most widely-used methods of discounted cash flow analysis: $\boxed{f} \boxed{NPV}$ (*net present value*) and $\boxed{f} \boxed{IRR}$ (*internal rate of return*). These functions enable you to analyze financial problems involving cash flows (money paid out or received) occurring at regular intervals. As in compound interest calculations, the interval between cash flows can be any time period; however, the amounts of these cash flows need not be equal.

To understand how to use $\boxed{f} \boxed{NPV}$ and $\boxed{f} \boxed{IRR}$, let's consider the cash flow diagram for an investment that requires an initial cash outlay (CF_0) and generates a cash flow (CF_1) at the end of the first year, and so on up to the final cash flow (CF_6) at the end of the sixth year. In the following diagram, the initial investment is denoted by CF_0 , and is depicted as an arrow pointing down from the time line since it is cash paid out. Cash flows CF_1 and CF_4 also point down from the time line, because they represent projected cash flow losses.

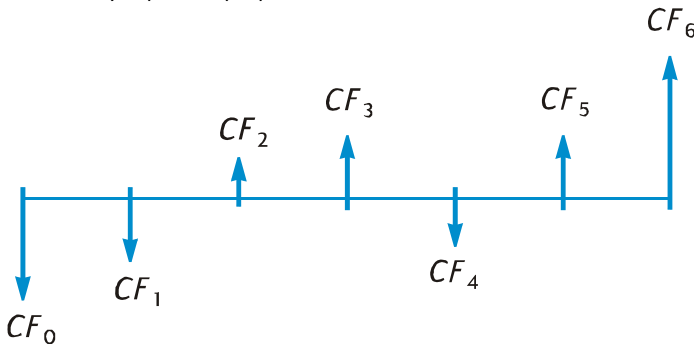

NPV is calculated by adding the initial investment (represented as a *negative* cash flow) to the present value of the anticipated future cash flows. The interest rate, i , will be referred to in this discussion of NPV and IRR as the *rate of return*.* The value of NPV indicates the result of the investment:

- If NPV is positive, the financial value of the investor's assets would be increased: the investment is financially attractive.

* Other terms are sometimes used to refer to the rate of return. These include: *required rate of return*, *minimally acceptable rate of return*, and *cost of capital*.

- If NPV is zero, the financial value of the investor's assets would not change: the investor is indifferent toward the investment.
- If NPV is negative, the financial value of the investor's assets would be decreased: the investment is not financially attractive.

A comparison of the NPV 's of alternative investment possibilities indicates which of them is most desirable: the greater the NPV , the greater the increase in the financial value of the investor's assets.

IRR is the rate of return at which the discounted future cash flows equal the initial cash outlay: IRR is the discount rate at which NPV is zero. The value of IRR relative to the present value discount rate also indicates the result of the investment:

- If IRR is greater than the desired rate of return, the investment is financially attractive.
- If IRR is equal to the desired rate of return, the investor is indifferent toward the investment.
- If IRR is less than the desired rate of return, the investment is not financially attractive.

Calculating Net Present Value (NPV)

Calculating NPV for Ungrouped Cash Flows. If there are no equal consecutive cash flows, use the procedure described (and then summarized) below. With this procedure, NPV (and IRR) problems involving up to 80 cash flows (in addition to the initial investment CF_0) can be solved. If two or more consecutive cash flows are equal — for example, if the cash flows in periods three and four are both \$8,500 — you can solve problems involving more than 80 cash flows, or you can minimize the number of storage registers required for problems involving less than 80 cash flows, by using the procedure described next (under Calculating NPV for Grouped Cash Flows, page 75).

The amount of the initial investment (CF_0) is entered into the calculator using the $\boxed{g} \boxed{CF_0}$ keys.

Each cash flow (CF_1 , CF_2 , etc.) is designated CF_j , where j takes on values from 1 up to the number of the final cash flow. The amount of a cash flow is entered using the $\boxed{g} \boxed{CF_1}$ keys. Each time $\boxed{g} \boxed{CF_1}$ is pressed, the amount in the display is stored in the next available storage register, and the number in the n register is increased by 1. This register therefore counts how many cash flow amounts (in addition to the initial investment CF_0) have been entered.

Note: When entering cash flow amounts — including the initial investment CF_0 — remember to observe the cash flow sign convention by pressing \boxed{CHS} after keying in a negative cash flow.

74 Section 4: Additional Financial Functions

In summary, to enter the cash flow amounts:

1. Press $\boxed{f}\boxed{CLEAR}\boxed{REG}$ to clear the financial and storage registers.
2. Key in the amount of the initial investment, press \boxed{CHS} if that cash flow is negative, then press $\boxed{g}\boxed{CF_0}$.
3. Key in the amount of the next cash flow, press \boxed{CHS} if the cash flow is negative, then press $\boxed{g}\boxed{CF_i}$. If the cash flow amount is zero in the next period, press 0 $\boxed{g}\boxed{CF_i}$.
4. Repeat step 3 for each cash flow until all have been entered.

With the amounts of the cash flows stored in the calculator's registers, you can calculate *NPV* as follows:

1. Enter the interest rate, using \boxed{i} or $\boxed{g}\boxed{12}\boxed{\div}$.
2. Press $\boxed{f}\boxed{NPV}$.

The calculated value of *NPV* appears in the display and also is automatically stored in the *PV* register.

Example: An investor has an opportunity to buy a duplex for \$80,000 and would like a return of at least 13%. He expects to keep the duplex 5 years and then sell it for \$130,000; and he anticipates the cash flows shown in the diagram below. Calculate *NPV* to determine whether the investment would result in a return or a loss.

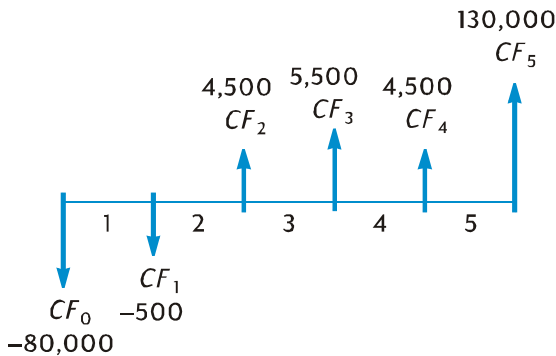

Note that although a cash flow amount (\$4,500) occurs twice, these cash flows are *not* consecutive. Therefore, these cash flows must be entered using the method described above.

Keystrokes

$\boxed{f}\boxed{CLEAR}\boxed{REG}$

80000 $\boxed{CHS}\boxed{g}\boxed{CF_0}$

Display

0.00

-80,000.00

Clears financial and storage registers.

Stores CF_0 (with minus sign for a negative cash flow).

| Keystrokes | Display | |
|----------------------------------|------------|--|
| 500 [CHS] [g] [CF ₁] | -500.00 | Stores CF_1 (with minus sign for a negative cash flow). |
| 4500 [g] [CF ₁] | 4,500.00 | Stores CF_2 . |
| 5500 [g] [CF ₁] | 5,500.00 | Stores CF_3 . |
| 4500 [g] [CF ₁] | 4,500.00 | Stores CF_4 . |
| 130000 [g] [CF ₁] | 130,000.00 | Stores CF_5 . |
| [RCL] [n] | 5.00 | Checks number of cash flow amounts entered (in addition to CF_0). |
| 13 [i] | 13.00 | Stores i . |
| [f] [NPV] | 212.18 | NPV. |

Since NPV is positive, the investment would increase the financial value of the investor's assets.

Calculating NPV for Grouped Cash Flows. A maximum of 80 cash flow amounts (in addition to the initial investment CF_0) can be stored in the hp 12c platinum.* However, problems involving more than 80 cash flows *can* be handled if among the cash flows there are *equal consecutive* cash flows. For such problems, you merely enter along with the amounts of the cash flows the number of times — up to 99 — each amount occurs consecutively. This number is designated N_i , corresponding to cash flow amount CF_i , and is entered using the [g] [N_i] keys. Each N_i is stored in a special register inside the calculator.

This method can, of course, be used for problems involving fewer than 80 cash flows — and it will require fewer storage registers than the method described above under Calculating NPV for Ungrouped Cash Flows. Equal consecutive cash flows *can* be entered using that method — provided there are enough storage registers available to accommodate the total number of individual cash flows. The facility of grouping equal consecutive cash flows is provided to minimize the number of storage registers required.

Note: When entering cash flow amounts — including the initial investment CF_0 — remember to observe the cash flow sign convention by pressing [CHS] after keying in the amount for a negative cash flow.

* If you have stored a program in the calculator, the number of registers available for storing cash flow amounts may be less than 81.

76 Section 4: Additional Financial Functions

In summary, to enter the amounts of the cash flows and the number of times they occur consecutively:

1. Press \boxed{f} CLEAR \boxed{REG} to clear the financial and storage registers.
2. Key in the amount of the initial investment, press \boxed{CHS} if that cash flow is negative, then press \boxed{g} $\boxed{CF_0}$.
3. If the initial investment consists of more than one cash flow of the amount entered in step 2, key in the number of those cash flows, then press \boxed{g} $\boxed{N_1}$. If \boxed{g} $\boxed{N_1}$ is not pressed, the calculator assumes that N_0 is 1.
4. Key in the amount of the next cash flow, press \boxed{CHS} if that cash flow is negative, then press \boxed{g} $\boxed{CF_1}$. If the cash flow amount is zero in the next period, press 0 \boxed{g} $\boxed{CF_1}$.
5. If the amount entered in step 4 occurs more than once consecutively, key in the number of times that cash flow amount occurs consecutively, then press \boxed{g} $\boxed{N_1}$. If \boxed{g} $\boxed{N_1}$ is not pressed, the calculator assumes that N_i is 1 for the CF_i just entered.
6. Repeat steps 4 and 5 for each CF_i and N_i until all cash flows have been entered.

With the amounts of the cash flows and the number of times they occur consecutively stored in the calculator, NPV can be calculated by entering the interest rate and pressing \boxed{f} \boxed{NPV} , just as described earlier.

Example: An investor has an opportunity to purchase a piece of property for \$79,000; and he would like a 13.5% return. He expects to be able to sell it after 10 years for \$100,000 and anticipates the yearly cash flows shown in the table below:

| Year | Cash Flow | Year | Cash Flow |
|------|-----------|------|-----------|
| 1 | \$14,000 | 6 | \$9,100 |
| 2 | \$11,000 | 7 | \$9,000 |
| 3 | \$10,000 | 8 | \$9,000 |
| 4 | \$10,000 | 9 | \$4,500 |
| 5 | \$10,000 | 10 | \$100,000 |

Since two cash flow amounts (\$10,000 and \$9,000) are repeated consecutively, we can minimize the number of storage registers required by using the method just described.

| Keystrokes | Display | |
|--|------------|--|
| \boxed{f} CLEAR \boxed{REG} | 0.00 | Clears financial and storage registers. |
| 79000 \boxed{CHS} \boxed{g} $\boxed{CF_0}$ | -79,000.00 | Initial investment (with minus sign for a negative cash flow). |
| 14000 \boxed{g} $\boxed{CF_1}$ | 14,000.00 | First cash flow amount. |
| 11000 \boxed{g} $\boxed{CF_2}$ | 11,000.00 | Next cash flow amount. |
| 10000 \boxed{g} $\boxed{CF_3}$ | 10,000.00 | Next cash flow amount. |
| 3 \boxed{g} $\boxed{N_i}$ | 3.00 | Number of times this cash flow amount occurs consecutively. |
| 9100 \boxed{g} $\boxed{CF_4}$ | 9,100.00 | Next cash flow amount. |
| 9000 \boxed{g} $\boxed{CF_5}$ | 9,000.00 | Next cash flow amount. |
| 2 \boxed{g} $\boxed{N_i}$ | 2.00 | Number of times this cash flow amount occurs consecutively. |
| 4500 \boxed{g} $\boxed{CF_6}$ | 4,500.00 | Next cash flow amount. |
| 100000 \boxed{g} $\boxed{CF_7}$ | 100,000.00 | Final cash flow amount. |
| \boxed{RCL} \boxed{n} | 7.00 | Seven different cash flow amounts have been entered. |
| 13.5 \boxed{i} | 13.50 | Stores i . |
| \boxed{f} NPV | 907.77 | NPV. |

Since NPV is positive, the investment would increase the financial value of the investor's assets by \$907.77.

Calculating Internal Rate of Return (IRR)

1. Enter the cash flows using either of the methods described above under Calculating Net Present Value.
2. Press $\boxed{f} \boxed{IRR}$.

The calculated value of *IRR* appears in the display and also is automatically stored in the *i* register.

Note: Remember that the $\boxed{f} \boxed{IRR}$ function may take a significant amount of time to produce an answer, during which the calculator displays **running**.

Example: The NPV calculated in the preceding example was positive, indicating that the actual rate of return (that is, the *IRR*) was greater than the 13.5 used in the calculation. Find the *IRR*.

Assuming the cash flows are still stored in the calculator, we need only press $\boxed{f} \boxed{IRR}$:

Keystrokes

Display

$\boxed{f} \boxed{IRR}$

13.72

IRR is 13.72%.

Note that the value calculated by $\boxed{f} \boxed{IRR}$ is the *periodic* rate of return. If the cash flow periods are other than years (for example, months or quarters), you can calculate the nominal annual rate of return by multiplying the periodic *IRR* by the number of periods per year.

As noted above, the calculator may take several seconds or even minutes to produce an answer for *IRR*. This is because the mathematical calculations for finding *IRR* are extremely complex, involving a series of iterations — that is, a series of successive calculations. In each iteration, the calculator uses an estimate of *IRR* as the interest rate in a computation of *NPV*. The iterations are repeated until the computed *NPV* reaches about zero.*

The complex mathematical characteristics of the *IRR* computation have an additional ramification: Depending on the magnitudes and signs of the cash flows, the computation of *IRR* may have a single answer, multiple answers, a negative answer or no answer.†

For additional information regarding $\boxed{f} \boxed{IRR}$, refer to Appendix C. For an alternative method of calculating *IRR*, refer to Section 13.

* In practice, because the complex mathematical calculations inside the calculator are done with numbers rounded to 10 digits, *NPV* may never reach exactly zero. Nevertheless, the interest rate that results in a very small *NPV* is very close to the actual *IRR*.

† In the case of multiple answers for *IRR*, the decision criteria listed on page 72 should be modified accordingly.

Reviewing Cash Flow Entries

- To display a single cash flow amount, press $\boxed{\text{RCL}}$, then key in the number of the register containing the cash flow amount to be displayed. Alternatively, store the number of that cash flow amount (that is, the value of j for the CF_j desired) in the n register, then press $\boxed{\text{RCL}} \boxed{g} \boxed{CF_j}$.
- To review *all* the cash flow amounts, press $\boxed{\text{RCL}} \boxed{g} \boxed{CF_j}$ repeatedly. This displays the cash flow amounts in *reverse* order — that is, beginning with the final cash flow and proceeding to CF_0 .
- To display the number of times a cash flow amount occurs consecutively — that is, to display the N_j for a CF_j — store the number of that cash flow amount (that is, the value of j) in the n register, then press $\boxed{\text{RCL}} \boxed{g} \boxed{N_j}$.
- To review all the cash flow amounts together with the number of times each cash flow amount occurs consecutively (that is, to review each CF_j and N_j pair), press $\boxed{\text{RCL}} \boxed{g} \boxed{N_j} \boxed{\text{RCL}} \boxed{g} \boxed{CF_j}$ repeatedly. This displays N_j followed by CF_j beginning with the final cash flow amount and proceeding to N_0 and CF_0 .

Note: Neither $\boxed{f} \boxed{\text{IRR}}$ nor $\boxed{f} \boxed{\text{NPV}}$ changes the number in the n register. However, each time $\boxed{\text{RCL}} \boxed{g} \boxed{CF_j}$ is pressed, the number in the n register is decreased by 1. If this is done, or if you manually change the number in the n register in order to display a single N_j and/or CF_j , be sure to reset the number in the n register to the total number of cash flow amounts originally entered (*not* including the amount of the initial investment CF_0). If this is not done, *NPV* and *IRR* calculations will give incorrect results; also, a review of cash flow entries would begin with N_n and CF_n , where n is the number currently in the n register.

For example, to display the fifth cash flow amount and the number of times that amount occurs consecutively:

| Keystrokes | Display | |
|--|----------|--|
| $\boxed{\text{RCL}} \boxed{5}$ | 9,000.00 | CF_5 |
| $\boxed{5} \boxed{n}$ | 5.00 | Stores the value of j in the n register. |
| $\boxed{\text{RCL}} \boxed{g} \boxed{N_j}$ | 2.00 | N_5 |
| $\boxed{7} \boxed{n}$ | 7.00 | Resets the number in the n register to its original value. |

80 Section 4: Additional Financial Functions

To display all the cash flow amounts and the number of times they occur consecutively:

| Keystrokes | Display | |
|--|----------------|--|
| $\boxed{\text{RCL}} \boxed{9} \boxed{\text{N}_i}$ | 1.00 | N_7 |
| $\boxed{\text{RCL}} \boxed{9} \boxed{\text{CF}_i}$ | 100,000.00 | CF_7 |
| $\boxed{\text{RCL}} \boxed{9} \boxed{\text{N}_i}$ | 1.00 | N_6 |
| $\boxed{\text{RCL}} \boxed{9} \boxed{\text{CF}_i}$ | 4,500.00 | CF_6 |
| $\boxed{\text{RCL}} \boxed{9} \boxed{\text{N}_i}$ | 2.00 | N_5 |
| $\boxed{\text{RCL}} \boxed{9} \boxed{\text{CF}_i}$ | 9,000.00 | CF_5 |
| . | . | . |
| . | . | . |
| . | . | . |
| $\boxed{\text{RCL}} \boxed{9} \boxed{\text{N}_i}$ | 1.00 | N_1 |
| $\boxed{\text{RCL}} \boxed{9} \boxed{\text{CF}_i}$ | 14,000.00 | CF_1 |
| $\boxed{\text{RCL}} \boxed{9} \boxed{\text{N}_i}$ | 1.00 | N_0 |
| $\boxed{\text{RCL}} \boxed{9} \boxed{\text{CF}_i}$ | -79,000.00 | CF_0 |
| $7 \boxed{\text{n}}$ | 7.00 | Resets the number in the n register to its original value. |

Changing Cash Flow Entries

- To change a cash flow amount:
 1. Key the amount into the display.
 2. Press $\boxed{\text{STO}}$.
 3. Key in the number of the register containing the cash flow amount to be changed.
- To change the number of times a cash flow amount occurs consecutively — that is, to change the N_i for a CF_i :
 1. Store the number of that cash flow amount (that is, i) in the n register.
 2. Key the number of times the cash flow amount occurs consecutively into the display.
 3. Press $\boxed{9} \boxed{\text{N}_i}$.

Note: If you change the number in the n register in order to change an N_i , be sure to reset the number in the n register to the total number of cash flow amounts originally entered (not including the amount of the initial investment CF_0). If this is not done, *NPV* and *IRR* calculations will give incorrect results.

Example 1: With the cash flows now stored in the calculator, change CF_2 from \$11,000 to \$9,000, then calculate the new *NPV* for a 13.5% return.

| Keystrokes | Display | |
|------------|----------|----------------------------------|
| 9000[STO]2 | 9,000.00 | Stores the new CF_2 in R_2 . |
| 13.5[i] | 13.50 | Stores i . * |
| [f][NPV] | -644.75 | The new <i>NPV</i> . |

Since this *NPV* is negative, the investment would decrease the financial value of the investor's assets.

Example 2: Change N_5 from 2 to 4, then calculate the new *NPV*.

| Keystrokes | Display | |
|------------|-----------|--|
| 5[n] | 5.00 | Stores j in the n register. |
| 4[g][Ni] | 4.00 | Stores the new N_5 . |
| 7[n] | 7.00 | Resets the number in the n register to its original value. |
| [f][NPV] | -1,857.21 | The new <i>NPV</i> . |

* This step is necessary in this example because we have calculated *IRR* since the first time we calculated *NPV*. The *IRR* calculation replaced the 13.5 we keyed into i before calculating *NPV* with the result for *IRR* – 13.72.

Bond Calculations

The hp 12c platinum enables you to solve for bond price (and the interest accrued since the last interest date) and the yield to maturity.* The \boxed{f} \boxed{PRICE} and \boxed{f} \boxed{YTM} calculations are done assuming a semiannual coupon payment and using an actual/actual basis (such as for U.S. Treasury bonds and U.S. Treasury notes). In accordance with market convention, prices are based on a redemption (par) value of 100.

To calculate bond price and yield for a 30/360 bond (that is, using the basis of a 30-day month and a 360-day year —such as for municipal bonds, corporate bonds, and to calculate bond price for bonds with an annual coupon payment), refer to Section 16: Bonds.

Bond Price

1. Enter the desired yield to maturity (as a percentage), using \boxed{i} .
2. Enter the annual coupon rate (as a percentage), using \boxed{PMT} .
3. Key in the settlement (purchase) date (as described on page 37), then press \boxed{ENTER} .
4. Key in the maturity (redemption) date.
5. Press \boxed{f} \boxed{PRICE} .

The price is shown in the display and also is stored in the PV register. The interest accrued since the last interest date is held inside the calculator: to display the interest, press $\boxed{x\text{>y}}$; to add the interest to the price, press $\boxed{+}$ in RPN mode and $\boxed{+}$ $\boxed{x\text{>y}}$ $\boxed{=}$ in ALG mode.

Example: What price should you pay on April 28, 2004 for a 6.75% U.S. Treasury bond that matures on June 4, 2018, if you want a yield of 4.75%. Assume that you normally express dates in the month-day-year format.

Keystrokes (RPN mode)

Display

| | | |
|-----------------------------|------------|--|
| 4.75 \boxed{i} | 4 . 75 | Enters yield to maturity. |
| 6.75 \boxed{PMT} | 6 . 75 | Enters coupon rate. |
| $\boxed{9}$ $\boxed{M.DY}$ | 6 . 75 | Sets date format to month-day-year. |
| 4.282004 \boxed{ENTER} | 4 . 28 | Enters settlement (purchase) date. |
| 6.042018 | 6 . 042018 | Enters maturity (redemption) date. |
| \boxed{f} \boxed{PRICE} | 120 . 38 | Bond price (as a percent of par). |
| $\boxed{+}$ | 123 . 07 | Total price, including accrued interest. |

* All bond calculations are performed in accordance with the Securities Industry Association's recommendations as contained in Jan Mayle, TIPS Inc., *Standard Securities Calculation Methods*, Volume 1, Third Edition, Securities Industry Association Inc., New York, 1993.

In ALG mode, perform the steps listed for RPN mode above but replace the last step with the step below.

| Keystrokes (ALG mode) | Display | |
|--|----------------|--|
| $\boxed{+}$ $\boxed{\times}$ \boxed{y} $\boxed{=}$ | 123.07 | Total price, including accrued interest. |

Bond Yield

1. Enter the quoted price (as a percent of par), using \boxed{PV} .
2. Enter the annual coupon rate (as a percentage), using \boxed{PMT} .
3. Key in the settlement (purchase) date, then press \boxed{ENTER} .
4. Key in the maturity (redemption) date.
5. Press \boxed{f} \boxed{YTM} .

The yield to maturity is shown in the display and also is stored in the *i* register.

Note: Remember that the \boxed{f} \boxed{YTM} function may take a significant amount of time to produce an answer, during which the calculator displays **running**.

Example: The market is quoting 122.125% for the bond described in the preceding example. What yield will that provide?

| Keystrokes | Display | |
|---------------------------|----------------|------------------------------------|
| 122.125 \boxed{PV} | 122.13 | Enters quoted price. |
| 6.75 \boxed{PMT} | 6.75 | Enters coupon rate. |
| 4.282004 \boxed{ENTER} | 4.28 | Enters settlement (purchase) date. |
| 6.042018 | 6.042018 | Enters maturity (redemption) date. |
| \boxed{f} \boxed{YTM} | 4.60 | Bond yield. |

After solving a bond problem, the FV register contains the redemption value plus the annual coupon rate percentage divided by two, and the n register contains the days from settlement date to the next coupon date divided by the number of days in the coupon period in which settlement occurs.

Depreciation Calculations

The hp 12c platinum enables you to calculate depreciation and the remaining depreciable value (book value minus salvage value) using the straight-line, sum-of-the-years-digits, and declining-balance methods. To do so with any of these methods:

1. Enter the original cost of the asset, using **[PV]**.
2. Enter the salvage value of the asset, using **[FV]**. If the salvage value is zero, press **0[FV]**.
3. Enter the expected useful life of the asset (in years), using **[n]**.
4. If the declining-balance method is being used, enter the declining-balance factor (as a percentage), using **[i]**. For example, 1.25 times the straight-line rate — 125 percent declining-balance — would be entered as **125[i]**.
5. Key in the number of the year for which depreciation is to be calculated.
6. Press:
 - **[f][SL]** for depreciation using the straight-line method.
 - **[f][SOYD]** for depreciation using the sum-of-the-years-digits method.
 - **[f][DB]** for depreciation using the declining-balance method.

[f][SL], **[f][SOYD]**, and **[f][DB]** each place the amount of depreciation in the display. To display the remaining depreciable value (the book value less the salvage value) after the depreciation has been calculated, press **[x↔y]**.

Example: A metalworking machine, purchased for \$10,000, is depreciated over 5 years. Its salvage value is estimated at \$500. Find the depreciation and remaining depreciable value for the first 3 years of the machine's life using the declining-balance method at double the straight-line rate (200 percent declining-balance).

Keystrokes

Display

| | | |
|-------------------|-----------|---|
| 10000 [PV] | 10,000.00 | Enters original cost. |
| 500 [FV] | 500.00 | Enters salvage value. |
| 5 [n] | 5.00 | Enters expected useful life. |
| 200 [i] | 200.00 | Enters declining-balance factor. |
| 1 [f][DB] | 4,000.00 | Depreciation in first year. |
| [x↔y] | 5,500.00 | Remaining depreciable value after first year. |
| 2 [f][DB] | 2,400.00 | Depreciation in second year. |

| Keystrokes | Display | |
|----------------------------------|----------|--|
| $\boxed{X \Rightarrow Y}$ | 3,100.00 | Remaining depreciable value after second year. |
| $\boxed{3} \boxed{f} \boxed{DB}$ | 1,440.00 | Depreciation in third year. |
| $\boxed{X \Rightarrow Y}$ | 1,660.00 | Remaining depreciable value after third year. |

To calculate depreciation and the remaining depreciable value when the acquisition date of the asset does not coincide with the beginning of the fiscal accounting year, refer to the procedures in Section 13. That section also includes a procedure for depreciation calculations when changing from the declining-balance method to the straight-line method, and a procedure for calculating excess depreciation.

Section 5

Additional Operating Features

Continuous Memory

The calculator's Continuous Memory contains the data storage registers, the financial registers, the stack and LAST X registers, program memory, and status information such as display format, date format, and payment mode. All information in Continuous Memory is preserved even while the calculator is turned off. Furthermore, information in Continuous Memory is preserved for a short time when the batteries are removed, so that you can change the batteries without losing your data and programs.

Continuous Memory may be reset if the calculator is dropped or otherwise traumatized, or if power is interrupted. You can also manually reset Continuous Memory as follows:

1. Turn the calculator off.
2. Hold down the \square key, and press \square ON.

When Continuous Memory is reset:

- All registers are cleared.
- Program memory consists of eight program lines, each containing the instruction \square 9 \square GTO 000.
- Display format is set to the standard format with two decimal places.
- Date format is set to month-day-year.
- Payment mode is set to End.
- Arithmetic operation is set to RPN mode.

Whenever Continuous Memory has been reset, the display will show **Pr Error**. Pressing any key will clear this message from the display.

The Display

Status Indicators

Nine indicators that appear along the bottom of the display signify the status of the calculator for certain operations. These status indicators are described elsewhere in this handbook where the relevant operation is discussed.

RPN ALG () f 9 BEGIN D.MY C PRGM

Number Display Formats

When the calculator is first turned on after coming from the factory or after Continuous Memory has been reset, answers are *displayed* with two decimal places.

| Keystrokes (RPN mode) | Display |
|-----------------------------------|---------|
| 19.8745632 $\boxed{\text{ENTER}}$ | 19.87 |
| 5 $\boxed{-}$ | 14.87 |

| Keystrokes (ALG mode) | Display |
|--------------------------|---------|
| 19.8745632 $\boxed{=}$ | 19.87 |
| 5 $\boxed{=}$ | 14.87 |

Although you see only two decimal places, all calculations in your hp 12c platinum are performed with full 10-digit numbers.

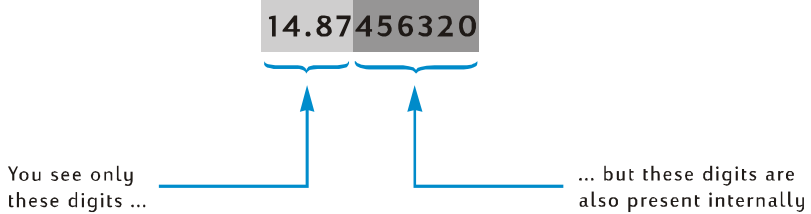

When only two decimal places are displayed, numbers are *rounded* to two decimal places: if the third digit is 5 through 9, the second digit is increased by one; if the third digit is 0 through 4, the second digit is not affected. Rounding occurs regardless of how many decimal places are displayed.

Several options are provided for controlling how numbers appear in the display. But regardless of which display format or how many displayed decimal places you specify, the number inside the calculator — which *appears* altered in the display — is not altered unless you use the $\boxed{\text{RND}}$, $\boxed{\text{AMORT}}$, $\boxed{\text{SL}}$, $\boxed{\text{SOYD}}$, or $\boxed{\text{DB}}$ functions.

Standard Display Format. The number 14.87 now in your calculator is currently being displayed in the standard display format with two decimal places shown. To display a different number of decimal places, press $\boxed{\text{f}}$ followed by a digit key (0 through 9) specifying the number of decimal places. In the following examples, notice how the displayed form of the number inside the calculator — 14.87456320 — is rounded to the specified number of digits.

| Keystrokes | Display |
|--------------|--------------------|
| $\boxed{f}4$ | 14.8746 |
| $\boxed{f}1$ | 14.9 |
| $\boxed{f}0$ | 15. |
| $\boxed{f}9$ | 14.87456320 |

Although nine decimal places were specified after \boxed{f} , only eight are displayed since the display can show a total of only 10 digits.

The standard display format, plus the specified number of decimal places, remain in effect until you change them; they are not reset each time the calculator is turned on. However, if Continuous Memory is reset, when the calculator is next turned on numbers will be displayed in the standard display format with two decimal places shown.

If a calculated answer is either too small or too large to be displayed in the standard display format, the display format automatically switches to scientific notation (described below). The display returns to the standard display format for all numbers that can be displayed in that format.

Scientific Notation Display Format

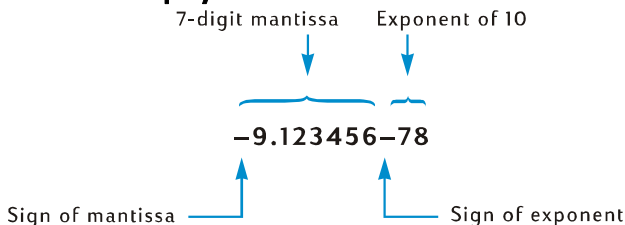

In scientific notation, a number is displayed with its *mantissa* at the left and a two-digit *exponent* at the right. The mantissa is simply the first seven digits in the number, and has a single, nonzero digit to the left of the decimal point. The exponent is simply how many decimal places you would move the decimal point in the mantissa before writing down the number in standard format. If the exponent is negative (that is, there is a minus sign between it and the mantissa), the decimal point should be moved to the left; this occurs for any number less than 1. If the exponent is positive (that is, there is a blank space between it and the mantissa), the decimal point should be moved to the right; this occurs for any number greater than or equal to 1.

To set the display format to scientific notation, press $\boxed{f} \boxed{\circ}$. For example (assuming the display still shows **14.87456320** from the preceding example):

Keystrokes

[f] [.]

Display

1.487456 01

The exponent in this example indicates that the decimal point should be moved one decimal place to the right, giving the number 14.87456, which is the first seven digits of the number previously in the display.

To set the display back to standard display format, press [f] followed by the desired number of decimal places. Scientific notation display format remains in effect until you change to the standard display format; it is not reset each time the calculator is turned on. However, if Continuous Memory is reset, when the calculator is next turned on the standard display format, with two decimal places, will be used.

Mantissa Display Format. Because both the standard display format and scientific notation display format often show only a few digits of a number, you may occasionally want to see all 10 digits — the full mantissa — of the number inside the calculator. To do so, press [f] CLEAR [PREFIX] and hold down the [PREFIX] key. The display will show all 10 digits of the number as long as you hold down the [PREFIX] key; after you release the key, the number will again be displayed in the current display format. For instance, if the display still contains the result from the preceding example:

Keystrokes

[f] CLEAR [PREFIX]

Display

1487456320

All 10 digits of the number inside the calculator.

1.487456 01

Display returns to its former contents when the [PREFIX] key is released.

[f] 2

14.87

Returns display to standard format.

Special Displays

Running. Certain functions and many programs may take several seconds or more to produce an answer. During these calculations, the word **running** flashes in the display to let you know that the calculator is running.

Overflow and Underflow. If a calculation results in a number whose magnitude is greater than $9.999999999 \times 10^{99}$, the calculation is halted and the calculator displays **9.999999 99** (if the number is positive) or **-9.999999 99** (if the number is negative).

If a calculation results in a number whose magnitude is less than 10^{-99} , the calculation is not halted, but the value 0 is used for that number in subsequent calculations.

Errors. If you attempt an improper operation — such as division by zero — the calculator will display the word **Error** followed by a digit (**0** through **9**). To clear the **Error** display, press any key. This does not execute that key's function, but does restore the calculator to its condition before the improper operation was attempted. Refer to Appendix D for a list of error conditions.

Pr Error. If power to the calculator is interrupted, the calculator will display **Pr Error** when next turned on. This indicates that Continuous Memory — which contains all data, program, and status information — has been reset.

The $\boxed{\times\rightleftharpoons y}$ Key in RPN Mode

Suppose you need to subtract \$25.83 from \$144.25, and you (mistakenly) key in 25.83 as the first number and then key in 144.25 as the second number. But then you realize that when written down on paper, the desired calculation reads $144.25 - 25.83$, so that you have unfortunately keyed in the *second* number first. To correct this mistake, merely exchange the first and second numbers by pressing $\boxed{\times\rightleftharpoons y}$, the *exchange* key.

Keystrokes (RPN mode)

25.83 $\boxed{\text{ENTER}}$ 144.25

Display

144.25

Oops! You mistakenly keyed in the *second number first*.

$\boxed{\times\rightleftharpoons y}$

25.83

Exchanges the first and second numbers. The first number keyed in is now in the display.

$\boxed{-}$

118.42

The answer is obtained by pressing the operation key.

The $\boxed{\times\rightleftharpoons y}$ key is also useful for checking the first number entered to make sure you keyed it in correctly. Before pressing the operation key or equals key, however, you should press $\boxed{\times\rightleftharpoons y}$ again to return the second number entered to the display. Regardless of how many times you press $\boxed{\times\rightleftharpoons y}$, the calculator considers the number in the display to be the *second* number entered.

The $\boxed{\text{LSTX}}$ Key in RPN Mode

Occasionally you may want to recall to the display the number that was there before an operation was performed. (This is useful for doing arithmetic calculations with constants and for recovering from errors in keying in numbers.) To do so, press $\boxed{g}\boxed{\text{LSTX}}$ (*LAST X*). This section describes how to use $\boxed{g}\boxed{\text{LSTX}}$ in RPN mode.

Arithmetic Calculations With Constants

Example: At Permex Pipes a certain pipe fitting is packaged in quantities of 15, 75, and 250. If the cost per fitting is \$4.38, calculate the cost of each package.

| Keystrokes (RPN mode) | Display | |
|--|--------------|--|
| 15 <input type="text" value="ENTER"/> | 15 . 00 | Keys first quantity into calculator. |
| 4.38 | 4 . 38 | Keys unit cost into display. |
| <input type="text" value="X"/> | 65 . 70 | Cost of a package of 15. |
| 75 | 75 . | Keys second quantity into display. |
| <input type="text" value="g"/> <input type="text" value="LSTx"/> | 4 . 38 | Recalls unit cost — which was last number in display before <input type="text" value="X"/> was pressed — into display. |
| <input type="text" value="X"/> | 328 . 50 | Cost of a package of 75. |
| 250 | 250 . | Keys third quantity into display. |
| <input type="text" value="g"/> <input type="text" value="LSTx"/> | 4 . 38 | Recalls unit cost into display again. |
| <input type="text" value="X"/> | 1 , 095 . 00 | Cost of a package of 250. |

Another method for doing arithmetic calculations with constants is described on page 240.

Recovering From Errors in Digit Entry

Example: Suppose you want to divide the total annual production for one of your firm's products (429,000) by the number of retail outlets (987) in order to calculate the average number distributed by each outlet. Unfortunately, you mistakenly key in the number of outlets as 9987 rather than as 987. It's easy to correct:

| Keystrokes (RPN mode) | Display | |
|--|----------------|--|
| 429000 <input type="text" value="ENTER"/> | 429 , 000 . 00 | |
| 9987 | 9 , 987 . | You haven't noticed your mistake yet. |
| <input type="text" value="÷"/> | 42 . 96 | About 43 products per outlet — but that seems too low! |
| <input type="text" value="g"/> <input type="text" value="LSTx"/> | 9 , 987 . 00 | Recalls to the display the number that was there before you press <input type="text" value="÷"/> . You see that you keyed it in wrong. |
| 429000 <input type="text" value="ENTER"/> | 429 , 000 . 00 | Begins the problem over. |

92 Section 5: Additional Operating Features

**Keystrokes
(RPN mode)**

987 $\boxed{\div}$

Display

434 . 65

The correct answer.

Section 6

Statistics Functions

Accumulating Statistics

The hp 12c platinum can perform one- or two-variable statistical calculations. The data is entered into the calculator using the $\Sigma+$ key, which automatically calculates and stores statistics of the data into storage registers R_1 , through R_6 . (These registers are therefore referred to as the “statistics registers.”)

Before beginning to accumulate statistics for a new set of data, you should clear the statistics registers by pressing f CLEAR Σ .*

In one-variable statistical calculations, to enter each data point — referred to as an “x-value” — key the x-value into the display, then press $\Sigma+$.

In two-variable statistical calculations, to enter each data pair — referred to as the “x and y-values”:

1. Key the y-value into the display.
2. Press ENTER.
3. Key the x-value into the display.
4. Press $\Sigma+$.

Each time you press $\Sigma+$, the calculator does the following:

- The number in R_1 is increased by 1, and the result is copied into the display.
- The x-value is added to the number in R_2 .
- The square of the x-value is added to the number in R_3 .
- The y-value is added to the number in R_4 .
- The square of the y-value is added to the number in R_5 .
- The product of the x and y-values is added to the number in R_6 .

* This also clears the stack registers and the display.

The table below shows where the accumulated statistics are stored.

| Register | Statistic |
|------------------------------|---|
| R ₁ (and display) | n : number of data pairs accumulated. |
| R ₂ | Σx : summation of x -values. |
| R ₃ | Σx^2 : summation of squares of x -values. |
| R ₄ | Σy : summation of y -values. |
| R ₅ | Σy^2 : summation of squares of y -values. |
| R ₆ | Σxy : summation of products of x -values and y -values. |

Correcting Accumulated Statistics

If you discover you have entered data incorrectly, the accumulated statistics can easily be corrected. Simply key in the incorrect data point or data pair again as if it were new, but press $\boxed{9} \boxed{\Sigma^-}$ instead of $\boxed{\Sigma^+}$. Then enter the correct data point or data pair and press $\boxed{\Sigma^+}$.

Mean

Pressing $\boxed{9} \boxed{\bar{x}}$ calculates the means (arithmetic averages) of the x -values (\bar{x}) and of the y -values (\bar{y}). The mean of the x -values appears in the display after $\boxed{9} \boxed{\bar{x}}$ is pressed; to display the mean of the y -values, press $\boxed{\bar{x} \bar{y}}$.

Example: A survey of seven salespersons in your company reveals that they work the following hours a week and sell the following dollar volumes each month. How many hours does the average salesperson work each week? How much does the average salesperson sell each month?

| Salesperson | Hours/Week | Sales/Month |
|-------------|------------|-------------|
| 1 | 32 | \$17,000 |
| 2 | 40 | \$25,000 |
| 3 | 45 | \$26,000 |
| 4 | 40 | \$20,000 |
| 5 | 38 | \$21,000 |
| 6 | 50 | \$28,000 |
| 7 | 35 | \$15,000 |

To find the average workweek and sales of this sample:

| Keystrokes | Display | |
|------------------------------------|---------------|--|
| \boxed{f} CLEAR $\boxed{\Sigma}$ | 0 . 00 | Clears statistics registers. |
| 32 \boxed{ENTER} | 32 . 00 | |
| 17000 $\boxed{\Sigma+}$ | 1 . 00 | First entry. |
| 40 \boxed{ENTER} | 40 . 00 | |
| 25000 $\boxed{\Sigma+}$ | 2 . 00 | Second entry. |
| 45 \boxed{ENTER} | 45 . 00 | |
| 26000 $\boxed{\Sigma+}$ | 3 . 00 | Third entry. |
| 40 \boxed{ENTER} | 40 . 00 | |
| 20000 $\boxed{\Sigma+}$ | 4 . 00 | Fourth entry. |
| 38 \boxed{ENTER} | 38 . 00 | |
| 21000 $\boxed{\Sigma+}$ | 5 . 00 | Fifth entry. |
| 50 \boxed{ENTER} | 50 . 00 | |
| 28000 $\boxed{\Sigma+}$ | 6 . 00 | Sixth entry. |
| 35 \boxed{ENTER} | 35 . 00 | |
| 15000 $\boxed{\Sigma+}$ | 7 . 00 | Total number of entries in the sample. |
| \boxed{g} $\boxed{\bar{x}}$ | 21 , 714 . 29 | Mean dollar sales per month (\bar{x}). |
| $\boxed{x \rightleftharpoons y}$ | 40 . 00 | Mean workweek in hours (\bar{y}). |

Standard Deviation

Pressing $\boxed{g} \boxed{S}$ calculates the standard deviation of the x -values (s_x) and of the y -values (s_y). (The standard deviation of a set of data is a measure of the dispersion around the mean.) The standard deviation of the x -values appears in the display after $\boxed{g} \boxed{S}$ is pressed; to display the standard deviation of the y -values, press $\boxed{x} \boxed{\neq} \boxed{y}$.

Example: To calculate the standard deviations of the x -values and of the y -values from the preceding example:

| Keystrokes | Display | |
|------------------------------------|----------|-------------------------------------|
| $\boxed{g} \boxed{S}$ | 4,820.59 | Standard deviation of sales. |
| $\boxed{x} \boxed{\neq} \boxed{y}$ | 6.03 | Standard deviation of hours worked. |

The formulas used in the hp 12c platinum for calculating s_x and s_y give *best estimates* of the population standard deviation based on a sample of the population. Thus, current statistical convention calls them *sample* standard deviations. So we have assumed that the seven salespersons are a sample of the population of *all salespersons*, and our formulas derive best estimates of the population from the sample.

What if the seven salespersons constituted the whole population of salespersons. Then we wouldn't need to *estimate* the *population* standard deviation. We can find the *true population* standard deviation (σ) when the data set equals the total population, using the following keystrokes.*

| Keystrokes | Display | |
|------------------------------------|-----------|------------------------|
| $\boxed{g} \boxed{\bar{x}}$ | 21,714.29 | Mean (dollars) |
| $\boxed{\Sigma+}$ | 8.00 | Number of entries + 1. |
| $\boxed{g} \boxed{S}$ | 4,463.00 | σ_x |
| $\boxed{x} \boxed{\neq} \boxed{y}$ | 5.58 | σ_y |

* It turns out that if you sum the mean of the population into the set itself and find the new s , computed using the formulas on page 262, that s will be the *population* standard deviation, σ , of the original set.

To continue summing data pairs, press $\boxed{g} \boxed{\bar{x}} \boxed{g} \boxed{\Sigma^-}$ before entering more data.

Note: In some cases involving data values that differ by a relatively small amount, the calculator cannot compute the standard deviation or the linear estimation accurately because such calculations would exceed the precision of the calculator. For instance, while the standard deviation of the values 1,999,999; 2,000,000 and 2,000,001 is 1; the standard deviation returned by the hp 12c platinum is 0 due to the effect of roundoff. This will not happen, however, if you normalize the data by keying only the difference between each value and the mean or approximate mean of the values. In the preceding example, the correct result can be obtained using the values -1 , 0 and 1 instead. Just remember to add the difference (2,000,000) back to the calculation of the average.

Linear Estimation

With two-variable statistical data accumulated in the statistics registers, you can estimate a new y -value (\hat{y}) given a new x -value, and estimate a new x -value (\hat{x}) given a new y -value.

To calculate \hat{y} and $\boxed{\hat{x}_r}$

1. Key in a new x -value.
2. Press $\boxed{g} \boxed{\hat{y}_r}$.

To calculate \hat{x} :

1. Key in a new y -value.
2. Press $\boxed{g} \boxed{\hat{x}_r}$.

Example: Using the accumulated statistics from the preceding problem, estimate the amount of sales delivered by a new salesperson working 48 hours per week.

Keystrokes

48 $\boxed{g} \boxed{\hat{x}_r}$

Display

28,818.93

Estimated sales for a 48 hour
workweek.

The reliability of a linear estimate depends upon how closely the data pairs would, if plotted on a graph, lie in a straight line. The usual measure of this reliability is the correlation coefficient, r . This quantity is automatically calculated whenever \hat{y} or \hat{x} is calculated; to display it, press $\boxed{\times \div y}$. A correlation coefficient close to 1 or -1 indicates that the data pairs lie very close to a straight line. On the other hand, a correlation coefficient close to 0 indicates that the data pairs do not lie closely to a straight line; and a linear estimate using this data would not be very reliable.

98 Section 6: Statistics Functions

Example: Check the reliability of the linear estimate in the preceding example by displaying the correlation coefficient.

| Keystrokes | Display | |
|------------------------|----------------|---|
| $\boxed{\times\div y}$ | 0.90 | The correlation coefficient is close to 1, so the sales calculated in the preceding example is a good estimate. |

To graph the regression line, calculate the coefficients of the linear equation $y = A + Bx$.

1. Press $0 \boxed{g} \boxed{\hat{y},r}$ to compute the y-intercept (A).
2. To compute the slope of the line (B) in RPN mode, press $1 \boxed{g} \boxed{\hat{y},r} \boxed{\times\div y} \boxed{R\downarrow} \boxed{\times\div y} \boxed{-}$. To compute the slope of the line (B) in ALG mode, press these keys: $1 \boxed{g} \boxed{\hat{y},r} \boxed{\times\div y} \boxed{R\downarrow} \boxed{-} \boxed{\times\div y} \boxed{=}$.

Example: Compute the slope and intercept of the regression line in the preceding example.

| Keystrokes (RPN mode) | Display | |
|---|----------------|---|
| $0 \boxed{g} \boxed{\hat{y},r}$ | 15.55 | y-intercept (A); projected value for $x = 0$. |
| $1 \boxed{g} \boxed{\hat{y},r} \boxed{\times\div y} \boxed{R\downarrow} \boxed{\times\div y} \boxed{-}$ | 0.001 | Slope of the line (B); indicates the change in the projected values caused by an incremental change in the x value. |

| Keystrokes (ALG mode) | Display | |
|---|----------------|---|
| $0 \boxed{g} \boxed{\hat{y},r}$ | 15.55 | y-intercept (A); projected value for $x = 0$. |
| $1 \boxed{g} \boxed{\hat{y},r} \boxed{\times\div y} \boxed{R\downarrow} \boxed{-} \boxed{\times\div y} \boxed{=}$ | 0.001 | Slope of the line (B); indicates the change in the projected values caused by an incremental change in the x value. |

The equation that describes the regression line is:

$$y = 15.55 + 0.001x$$

Weighted Mean

You can compute the weighted mean of a set of numbers if you know the corresponding weights of the items in question.

1. Press \boxed{f} CLEAR $\boxed{\Sigma}$.
2. Key in the value of the item and press \boxed{ENTER} , then key in its weight and press $\boxed{\Sigma+}$. Key in the second item's value, press \boxed{ENTER} , key in the second weight, and press $\boxed{\Sigma+}$. Continue until you have entered all the values of the items and their corresponding weights. The rule for entering the data is "item \boxed{ENTER} weight $\boxed{\Sigma+}$."
3. Press \boxed{g} $\boxed{\bar{x}_w}$ to calculate the weighted mean of the items.

Example: Suppose that you stop during a vacation drive to purchase gasoline at four stations as follows: 15 gallons at \$1.16 per gallon, 7 gallons at \$1.24 per gallon, 10 gallons at \$1.20 per gallon, and 17 gallons at \$1.18 per gallon. You want to find the average cost per gallon of gasoline purchased. If you purchased the same quantity at each station, you could determine the simple arithmetic average or mean using the \boxed{g} $\boxed{\bar{x}}$ keys. But since you know the value of the item (gasoline) and its corresponding weight (number of gallons purchased), use the \boxed{g} $\boxed{\bar{x}_w}$ keys to find the weighted mean:

| Keystrokes | Display | |
|---|---------|--------------------------------|
| \boxed{f} CLEAR $\boxed{\Sigma}$ | 0.00 | Clears statistics registers. |
| 1.16 \boxed{ENTER} 15 $\boxed{\Sigma+}$ | 1.00 | First item and weight. |
| 1.24 \boxed{ENTER} 7 $\boxed{\Sigma+}$ | 2.00 | Second item and weight. |
| 1.2 \boxed{ENTER} 10 $\boxed{\Sigma+}$ | 3.00 | Third item and weight. |
| 1.18 \boxed{ENTER} 17 $\boxed{\Sigma+}$ | 4.00 | Fourth item and weight. |
| \boxed{g} $\boxed{\bar{x}_w}$ | 1.19 | Weighted mean cost per gallon. |

A procedure for calculating the standard deviation and standard error (as well as the mean) of weighted or grouped data is included in the *hp 12c platinum Solutions Handbook*.

Section 7

Mathematics and Number-Alteration Functions

The *hp 12c platinum* provides several keys for mathematical functions and for altering numbers. These functions are useful for specialized financial calculations as well as for general mathematics calculations.

One-Number Functions

Most of the mathematics functions require that only one number be in the calculator (that is, the number in the display) before the function key is pressed. Pressing the function key then replaces the number in the display by the result.

Reciprocal. Pressing $\boxed{1/x}$ calculates the reciprocal of the number in the display — that is, it divides 1 by the number in the display.

Square. Pressing $\boxed{g} \boxed{x^2}$ calculates the square of the number in the display.

Square Root. Pressing $\boxed{g} \boxed{\sqrt{x}}$ calculates the square root of the number in the display.

Logarithm. Pressing $\boxed{g} \boxed{LN}$ calculates the natural logarithm (that is, the logarithm to the base e) of the number in the display. To calculate the common logarithm (that is, the logarithm to the base 10) of the number in the display, calculate the natural logarithm, then press $10 \boxed{g} \boxed{LN} \boxed{\div}$ in RPN mode and $\boxed{\div} \boxed{10} \boxed{g} \boxed{LN} \boxed{=}$ in ALG mode.

Exponential. Pressing $\boxed{g} \boxed{e^x}$ calculates the exponential of the number in the display — that is, it raises the base e to the number in the display.

Factorial. Pressing $\boxed{g} \boxed{n!}$ calculates the factorial of the number in the display — that is, it calculates the product of the integers from 1 to n , where n is the number in the display.

Round. The display format specifies to how many decimal places a number inside the calculator is rounded when it appears in the display; but the display format alone does not affect the number itself inside the calculator. Pressing $\boxed{f} \boxed{RND}$, however, changes the number inside the calculator to match its displayed version. Thus, to round a number in the display to a given number of decimal places, temporarily set the display format (as described on page 87) to show the desired number of decimal places, then press $\boxed{f} \boxed{RND}$.

Integer. Pressing $\boxed{9} \boxed{\text{INTG}}$ replaces the number in the display by its integer portion — that is, it replaces each digit to the right of the decimal point by 0. The number is changed inside the calculator as well as in the display. In RPN mode, the original number can be recalled to the display by pressing $\boxed{9} \boxed{\text{LSTx}}$.

Fractional. Pressing $\boxed{9} \boxed{\text{FRAC}}$ replaces the number in the display by its fractional portion — that is, it replaces all digits to the left of the decimal point by 0. Like $\boxed{9} \boxed{\text{INTG}}$, $\boxed{9} \boxed{\text{FRAC}}$ changes the number inside the calculator as well as its displayed version. In RPN mode, the original number can be recalled to the display by pressing $\boxed{9} \boxed{\text{LSTx}}$.

All of the above functions are used basically in the same way. For example, to find the reciprocal of 0.258:

| Keystrokes | Display | |
|-------------------|----------------|---|
| .258 | 0 .258 | Keys the number into the display. |
| $\boxed{1/x}$ | 3 .88 | The reciprocal of 0.258, the original number. |

Any of the above functions can be done with a number in the display resulting from a previous calculation, as well as with a number you have just keyed in. The examples below indicate how $\boxed{9} \boxed{\text{LSTx}}$ can recall the original number for further use in RPN mode.

| Keystrokes (RPN mode) | Display | |
|--|----------------|--|
| $\boxed{f} \boxed{\text{CLEAR}} \boxed{\text{PREFIX}}$ | 3875968992 | Displays all 10 digits of the number inside the calculator. |
| | 3 .88 | Display returns to normal format when $\boxed{\text{PREFIX}}$ key is released. |
| $\boxed{f} \boxed{\text{RND}}$ | 3 .88 | The number now in the display appears the same as before, but ... |
| $\boxed{f} \boxed{\text{CLEAR}} \boxed{\text{PREFIX}}$ | 388000000 | Displaying all 10 digits of the number inside the calculator shows $\boxed{f} \boxed{\text{RND}}$ has changed the number to match its displayed version. |
| | 3 .88 | Display returns to normal format. |
| $\boxed{9} \boxed{\text{INTG}}$ | 3 .00 | The integer portion of the number previously displayed. |
| $\boxed{9} \boxed{\text{LSTx}}$ | 3 .88 | Recalls the original number to the display in RPN mode only. |

102 Section 7: Mathematics and Number-Alteration Functions

Keystrokes (RPN mode)

\boxed{g} $\boxed{\text{FRAC}}$

Display

0 . 88

The fractional portion of the number previously displayed.

The Power Function in RPN Mode

Pressing $\boxed{y^x}$ calculates a power of a number — that is, y^x . Like the arithmetic function $\boxed{+}$, $\boxed{y^x}$ requires two numbers:

1. Key in the base number (which is designated by the y on the key).
2. Press $\boxed{\text{ENTER}}$ to separate the second number (the exponent) from the first (the base).
3. Key in the exponent (which is designated by the x on the key).
4. Press $\boxed{y^x}$ to calculate the power.

| To Calculate | Keystrokes (RPN mode) | Display |
|----------------------------|---|---------|
| $2^{1.4}$ | 2 $\boxed{\text{ENTER}}$ 1.4 $\boxed{y^x}$ | 2 . 64 |
| $2^{-1.4}$ | 2 $\boxed{\text{ENTER}}$ 1.4 $\boxed{\text{CHS}}$ $\boxed{y^x}$ | 0 . 38 |
| $(-2)^3$ | 2 $\boxed{\text{CHS}}$ $\boxed{\text{ENTER}}$ 3 $\boxed{y^x}$ | -8 . 00 |
| $\sqrt[3]{2}$ or $2^{1/3}$ | 2 $\boxed{\text{ENTER}}$ 3 $\boxed{1/x}$ $\boxed{y^x}$ | 1 . 26 |

The Power Function in ALG Mode

To calculate a power of a number, that is, y^x , in ALG mode, do the following:

1. Key in the base number (which is designated by the y on the key).
2. Press $\boxed{y^x}$ and key in the exponent (which is designated by the x on the key)
3. Press $\boxed{=}$ to calculate the power.

| To Calculate | Keystrokes (ALG mode) | Display |
|--------------|--|---------|
| $2^{1.4}$ | 2 $\boxed{y^x}$ 1.4 $\boxed{=}$ | 2 . 64 |
| $2^{-1.4}$ | 2 $\boxed{y^x}$ 1.4 $\boxed{\text{CHS}}$ $\boxed{=}$ | 0 . 38 |
| $(-2)^3$ | 2 $\boxed{\text{CHS}}$ $\boxed{y^x}$ 3 $\boxed{=}$ | -8 . 00 |

| To Calculate | Keystrokes (ALG mode) | Display |
|----------------------------|---|---------|
| $\sqrt[3]{2}$ or $2^{1/3}$ | 2 $\boxed{y^x}$ 3 $\boxed{1/x}$ $\boxed{=}$ | 1.26 |

Part II
Programming

Section 8

Programming Basics

Why Use Programs?

A program is simply a sequence of keystrokes that is stored in the calculator. Whenever you have to calculate with the same sequence of keystrokes several times, you can save a great deal of time by incorporating these keystrokes in a program. Instead of pressing all the keys each time, you press just one key to start the program: the calculator does the rest automatically!

Creating a Program

Creating a program consists simply of writing the program, then storing it:





1. Write down the sequence of keystrokes that you would use to calculate the quantity or quantities desired.
2. Select the mode you want to use (by pressing \boxed{f} \boxed{RPN} or \boxed{f} \boxed{ALG}).





Note: Programs or steps created and saved in RPN mode should only be executed in RPN mode, and programs or steps created and saved in ALG mode should only be executed in ALG mode. (You can also create steps in your program to switch to the appropriate mode.)

3. Press \boxed{f} $\boxed{P/R}$ to set the calculator to *Program mode*. When the calculator is in Program mode, functions are not executed when they are keyed in, but instead are stored inside the calculator. The **PRGM** status indicator in the display is lit when the calculator is in Program mode.
4. Press \boxed{f} \boxed{CLEAR} \boxed{PRGM} to erase any previous programs that may be stored inside the calculator. If you want to create a new program without erasing a program already stored, skip this step and proceed as described in Section 11, Multiple Programs.
5. Key in the sequence of keystrokes that you wrote down in step 1. Skip the beginning keystrokes that enter data, which would differ each time the program is used.





Example: Your office supplies dealer is selling selected stock at 25% off. Create a program that calculates the net cost of an item after the discount is subtracted and the \$5 handling charge is added.

First, we'll manually calculate the net cost of an item listing for \$200.

| Keystrokes (RPN mode) | Display | |
|--|----------------|---|
| 200 | 200 . | Keys in cost of item. |
|  | 200 . 00 | Separates cost of item from percentage to be keyed in next. |
| 25  | 50 . 00 | Amount of discount. |
|  | 150 . 00 | Price less discount. |
| 5 | 5 . | Handling charge. |
|  | 155 . 00 | Net cost (price less discount plus handling charge). |

| Keystrokes (ALG mode) | Display | |
|--|----------------|---|
| 200 | 200 . | Keys in cost of item. |
|  | 200 . 00 | Separates cost of item from percentage to be keyed in next. |
| 25  | 50 . 00 | Amount of discount. |
|  | 150 . 00 | Price less discount. |
| 5 | 5 . | Handling charge. |
|  | 155 . 00 | Net cost (price less discount plus handling charge). |

Next, set the calculator to Program mode and erase any program(s) already stored:

| Keystrokes | Display | |
|---|----------------|----------------------------------|
|   | | Sets calculator to Program mode. |
|  CLEAR  | 000 , | Clears program(s). |

Finally, press the keys that we used above to solve the problem manually. Do not key in 200; this number will vary each time the program is used. Don't be concerned right now about what appears in the display as you press the keys; we'll discuss that later in this section.

**Keystrokes
(RPN mode)**

Display

| | | |
|--------------|------|----|
| ENTER | 001, | 36 |
| 2 | 002, | 2 |
| 5 | 003, | 5 |
| % | 004, | 25 |
| - | 005, | 30 |
| 5 | 006, | 5 |
| + | 007, | 40 |

**Keystrokes
(ALG mode)**

Display

| | | |
|----------|------|----|
| - | 001, | 30 |
| 2 | 002, | 2 |
| 5 | 003, | 5 |
| % | 004, | 25 |
| + | 005, | 40 |
| 5 | 006, | 5 |
| = | 007, | 36 |

Running a Program

To run (sometimes called “execute”) a program:

1. Press **f** **P/R** to set the calculator back to Run mode. If the calculator is already in Run mode (that is, the **PRGM** status indicator in the display is not lit), skip this step.
2. Key any required data into the calculator, just as if you were calculating manually. When a program is run, it uses the data already keyed into the display and the registers inside the calculator.
3. Press **R/S** to begin program execution.

Example: Run the program created above to calculate the net cost of a typewriter listing for \$625 and an executive chair listing for \$159.

**Keystrokes
(RPN mode)**

| | Display | |
|-------|----------------|--|
| f P/R | 155 . 00 | Sets calculator to Run mode. Display shows number previously calculated. |
| f RPN | 155 . 00 | Sets RPN mode. |
| 625 | 625 . | Keys in price of typewriter. |
| R/S | 473 . 75 | Net cost of typewriter. |
| 159 | 159 . | Keys in list price of chair. |
| R/S | 124 . 25 | Net cost of chair. |

**Keystrokes
(ALG mode)**

| | Display | |
|-------|----------------|--|
| f P/R | 155 . 00 | Sets calculator to Run mode. Display shows number previously calculated. |
| f ALG | 155 . 00 | Sets ALG mode. |
| 625 | 625 . | Keys in price of typewriter. |
| R/S | 473 . 75 | Net cost of typewriter. |
| 159 | 159 . | Keys in list price of chair. |
| R/S | 124 . 25 | Net cost of chair. |

That's all there is to creating and running simple programs! But if you want to use programs frequently, you'll want to know more about programming — such as how to check what keystrokes are stored in program memory, how many keystrokes can be stored in program memory, how to correct or otherwise modify programs, how to skip keystrokes when running a program, and so on. Before you can understand these aspects of programming, we need to briefly discuss how keystrokes are treated by the calculator when they are stored in Program mode and when they are executed in Run mode.

Program Memory

Keystrokes entered into the calculator in Program mode are stored in *program memory*. Each digit, decimal point, or function key is called an *instruction* and is stored in one *line* of program memory — usually referred to simply as a *program line*. Keystroke sequences beginning with the \boxed{f} , \boxed{g} , \boxed{STO} , \boxed{RCL} , and \boxed{GTO} prefix keys are considered to comprise a *complete instruction* and are stored in only one program line.

When a program is run, each instruction in program memory is executed — that is, the keystroke in that program line is performed, just as if you were pressing the key manually — beginning with the current line in program memory and proceeding sequentially with the higher-numbered program lines.

Whenever the calculator is in Program mode (that is, whenever the **PRGM** status indicator in the display is lit), the display shows information about the program line to which the calculator is currently set. At the left of the display is the number of the program line within program memory. The remaining digits in the display comprise a code that indicates what instruction has been stored in that program line. No code is shown for program line 000, since no regular instruction is stored there.

Identifying Instructions in Program Lines

Each key on the hp 12c platinum keyboard — except for the digit keys 0 through 9 — is identified by a two-digit “keycode” that corresponds to the key’s position on the keyboard. The first digit in the keycode is the number of the key row, counting from row 1 at the top; the second digit is the number of the key in that row, counting from 1 for the first key in the row through 9 for the ninth key in the row and 0 for the tenth key in the row. The keycode for each digit key is simply the digit on the key. Thus, when you keyed the instruction $\boxed{\%}$ into program memory, the calculator displays a line number and a keycode

004, 25

This indicates that the key for the instruction in program line 004 is in the second row on the keyboard and is the fifth key in that row: the $\boxed{\%}$ key. When you keyed the instruction $\boxed{+}$ into program memory, the calculator displays a line number and keycode as

007, 40

This indicates that the key for the instruction in program line 007 is in the fourth row on the keyboard and is the tenth key in that row: the $\boxed{+}$ key. When you keyed the digit 5 into program memory, the keycode displayed was only the digit **5**.

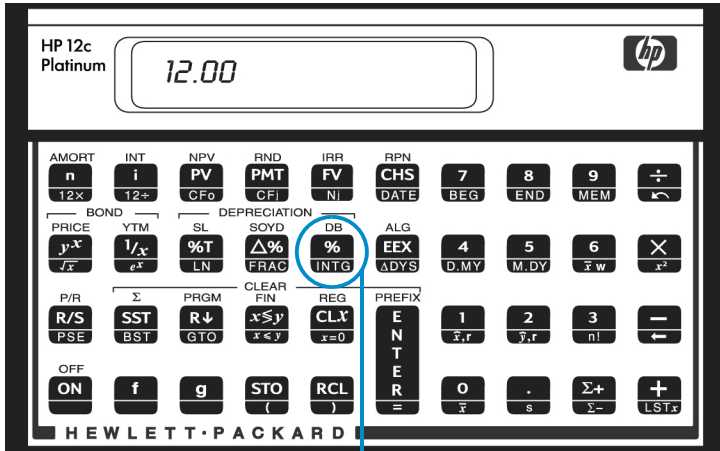

Second row, fifth key

Since keystroke sequences beginning with **f**, **g**, **STO**, **RCL**, and **GTO** are stored in only one program line, the display of that line would show the keycodes for all the keys in the keystroke sequence.

Instruction

Keycode

| | |
|--------------------------------|-------------------------|
| g ADYS | nnn, 43 26 |
| STO + 0 | nnn, 44 40 0 |
| g GTO 000 | nnn, 43, 33, 000 |

Displaying Program Lines

Pressing **f** **P/R** to set the calculator from Run mode to Program mode displays the line number and keycode for the program line to which the calculator is currently set.

Occasionally you'll want to check several or all of the instructions stored in program memory. The hp 12c platinum enables you to review program instructions either forward or backward through program memory:

- Pressing **SST** (*single step*) while the calculator is in Program mode advances the calculator to the next line in program memory, then displays that line number and the keycode of the instruction stored there.
- Pressing **g** **BST** (*back step*) while the calculator is in Program mode sets the calculator back to the previous line in program memory, then displays that line number and the keycode of the instruction stored there.

112 Section 8: Programming Basics

For example, to display the first two lines of the program now stored in program memory, set the calculator to Program mode and press **SST** twice:

| Keystrokes (RPN mode) | Display | | |
|----------------------------------|----------------|----|---|
| f P/R | 000 , | | Sets calculator to Program mode and displays current line of program memory |
| SST | 001 , | 36 | Program line 001: ENTER |
| SST | 002 , | 2 | Program line 002: digit 2. |

| Keystrokes (ALG mode) | Display | | |
|----------------------------------|----------------|----|---|
| f P/R | 000 , | | Sets calculator to Program mode and displays current line of program memory |
| SST | 001 , | 30 | Program line 001: - |
| SST | 002 , | 2 | Program line 002: digit 2. |

Pressing **g** **BST** does the reverse:

| Keystrokes (RPN mode) | Display | | |
|----------------------------------|----------------|----|-------------------|
| g BST | 001 , | 36 | Program line 001. |
| g BST | 000 , | | Program line 000. |

| Keystrokes (ALG mode) | Display | | |
|----------------------------------|----------------|----|-------------------|
| g BST | 001 , | 30 | Program line 001. |
| g BST | 000 , | | Program line 000. |

If either the **SST** key or the **BST** key is held down, the calculator displays *all* of the lines in program memory. Press **SST** again now, but this time hold it down until program line 007 is displayed.

| Keystrokes (RPN mode) | Display | | |
|----------------------------------|----------------|----|------------------|
| SST | 001 , | 36 | Program line 001 |
| | . | | . |
| | . | | . |
| | . | | . |
| (Release SST) | 007 , | 40 | Program line 007 |

| Keystrokes (ALG mode) | Display | | |
|----------------------------------|----------------|----|------------------|
| SST | 001 , | 30 | Program line 001 |
| | . | | . |
| | . | | . |
| | . | | . |
| (Release SST) | 007 , | 36 | Program line 007 |

Program line 007 contains the last instruction *you keyed* into program memory. However, if you press **SST** again, you'll see that this is *not* the last line *stored* in program memory:

| Keystrokes | Display | | |
|-------------------|---------------------|--|------------------|
| SST | 008 , 43 , 33 , 000 | | Program line 008 |

As you should now be able to tell from the keycodes displayed, the instruction in program line 008 is **GTO**000.

The $\overline{\text{GTO}}000$ Instruction and Program Line 000

Whenever you run the program now stored in program memory, the calculator executes the instruction in line 008 after executing the seven instructions you keyed in. This $\overline{\text{GTO}}000$ instruction — as its name implies — tells the calculator to “go to” program line 000 and execute the instruction in that line. Although line 000 does not contain a regular instruction, it does contain a “hidden” instruction that tells the calculator to halt program execution. Thus, after each time the program is run, the calculator automatically goes to program line 000 and halts, ready for you to key in new data and run the program again. (The calculator is also automatically set to program line 000 when you press $\overline{\text{f}} \overline{\text{P/R}}$ to set the calculator from Program mode to Run mode or when $\overline{\text{f}} \overline{\text{CLEAR}} \overline{\text{PRGM}}$ is pressed in *run* mode.)

The $\overline{\text{GTO}}000$ instruction was already stored in line 008 — in fact, in *all* program lines — *before* you keyed in the program. If no instructions have been keyed into program memory, if Continuous Memory is reset, or if $\overline{\text{f}} \overline{\text{CLEAR}} \overline{\text{PRGM}}$ is pressed (in Program mode), the instruction $\overline{\text{GTO}}000$ is automatically stored in program lines 001 through 008. As you key each instruction into program memory, it replaces the $\overline{\text{GTO}}000$ instruction in that program line.

If your program should consist of exactly eight instructions, there would be no $\overline{\text{GTO}}000$ instructions remaining at the end of program memory. Nevertheless, after such a program is executed the calculator automatically returns to program line 000 and halts, just as if there were a $\overline{\text{GTO}}000$ instruction following the program.

If you key in more than eight instructions, program memory automatically expands to accommodate the additional instructions.

Expanding Program Memory

If no instructions have been keyed into program memory, if Continuous Memory has been reset, or if $\overline{\text{f}} \overline{\text{CLEAR}} \overline{\text{PRGM}}$ has been pressed (in Program mode), program memory consists of 8 program lines, and there are 20 storage registers available for storage of data.

Program Memory

| |
|-----|
| 000 |
| 001 |
| 002 |
| 003 |
| 004 |
| 005 |
| 006 |
| 007 |
| 008 |

Storage Registers

| | | | |
|----------------|--|----------------|--|
| R ₀ | | R ₀ | |
| R ₁ | | R ₁ | |
| R ₂ | | R ₂ | |
| R ₃ | | R ₃ | |
| R ₄ | | R ₄ | |
| R ₅ | | R ₅ | |
| R ₆ | | R ₆ | |
| R ₇ | | R ₇ | |
| R ₈ | | R ₈ | |
| R ₉ | | R ₉ | |

To determine at any time how many program lines (including those containing `GTO000`) are currently in program memory, press `G|MEM` (*memory*). The calculator will respond with a display like the following:

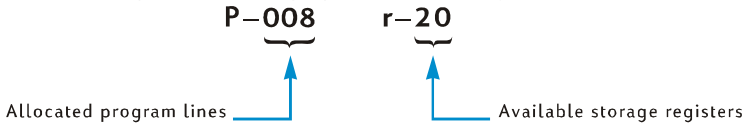

If you find yourself creating long programs, you should create your programs so that they don't use up program lines unnecessarily, since program memory is limited to 400 program lines. One way to minimize program length is to replace numbers consisting of more than just one digit — like the number 25 in lines 002 and 003 of the program keyed in above — by a `RCL` instruction, and then storing the number in the designated storage register before running the program. In this case, this would save one program line, since the `RCL` instruction requires only one program line, not two as are required by the number 25. Of course, doing so uses up data storage registers that you might want to save for other data. As in many business and financial decisions, there is a trade off involved; here it is between program lines and data storage registers.

Setting the Calculator to a Particular Program Line

There will be occasions when you'll want to set the calculator directly to a particular program line — such as when you're storing a second program in program memory or when you're modifying an existing program. Although you can set the calculator to any line by using **[SST]** as described above, you can do so more quickly as follows:

- With the calculator in Program mode, pressing **[9][GTO][▢]** followed by three digit keys sets the calculator to the program line specified by the digit keys, and then displays that line number and the keycode of the instruction stored there.
- With the calculator in Run mode, pressing **[9][GTO]** followed by three digit keys sets the calculator to the program line specified by the digit keys. Since the calculator is not in Program mode, the line number and keycode are not displayed.

The decimal point is not necessary if the calculator is in Run mode, but it *is* necessary if the calculator is in Program mode.

For example, assuming the calculator is still in Program mode, you can set it to program line 000 as follows:

| Keystrokes | Display |
|-----------------------|--|
| [9][GTO][▢]000 | 000, Program line 000 |

Executing a Program One Line at a Time

Pressing **[SST]** repeatedly with the calculator in Program mode (as described earlier) enables you to verify that the program you have *stored* is identical to the program you *wrote* — that is, to verify that you have keyed the instructions in correctly. However, this does not ensure that the program you *wrote* calculates the desired results correctly: even programs created by the most experienced programmers often do not work correctly when they are first written.

To help you verify that your program works correctly, you can execute the program one line at a time, using the **[SST]** key. Pressing **[SST]** while the calculator is in Run mode advances the calculator to the next line in program memory, then displays that line's number and the keycode of the instruction stored there, just as in Program mode. In *Run* mode, however, when the **[SST]** key is released the instruction in the program line just displayed is executed and the display then shows the result of executing that line.

For example, to execute the program stored in the calculator one line at a time:

**Keystrokes
(RPN mode)**

f P/R

Display

124 . 25

Sets calculator to Run mode and to line 000 in program memory. (Display shown assumes results remain from previous calculation.)

625

625 .

Keys in price of typewriter.

SST

001 ,

36 Program line 001: ENTER

625 . 00

Result of executing program line 001.

SST

002 ,

2 Program line 002: 2.

2 .

Result of executing program line 002.

SST

003 ,

5 Program line 003: 5.

25 .

Result of executing program line 003.

SST

004 ,

25 Program line 004: %

156 . 25

Result of executing program line 004.

SST

005 ,

30 Program line 005: -

468 . 75

Result of executing program line 005.

SST

006 ,

5 Program line 006: 5

5 .

Result of executing program line 006.

SST

007 ,

40 Program line 007: +

473 . 75

Result of executing program line 007 (the last line of the program).

**Keystrokes
(ALG mode)**

Display

| | | |
|--|---------------------------|--|
| <p>f P/R</p> | <p>124 . 25</p> | <p>Sets calculator to Run mode and to line 000 in program memory. (Display shown assumes results remain from previous calculation.)</p> |
| <p>625</p> | <p>625 .</p> | <p>Keys in price of typewriter.</p> |
| <p>SST</p> | <p>001 , 625 . 00</p> | <p>30 Program line 001: - Result of executing program line 001 .</p> |
| <p>SST</p> | <p>002 , 2 .</p> | <p>2 Program line 002: 2. Result of executing program line 002 .</p> |
| <p>SST</p> | <p>003 , 25 .</p> | <p>5 Program line 003: 5. Result of executing program line 003 .</p> |
| <p>SST</p> | <p>004 , 156 . 25</p> | <p>25 Program line 004: % Result of executing program line 004 .</p> |
| <p>SST</p> | <p>005 , 468 . 75</p> | <p>40 Program line 005: + Result of executing program line 005 .</p> |
| <p>SST</p> | <p>006 , 5 .</p> | <p>5 Program line 006: 5 Result of executing program line 006 .</p> |
| <p>SST</p> | <p>007 , 473 . 75</p> | <p>36 Program line 007: = Result of executing program line 007 (the last line of the program).</p> |

Pressing g BST while the calculator is in Run mode sets the calculator to the previous line in program memory, then displays that line's number and the keycode of the instruction stored there, just as in Program mode. In *Run* mode, however, when the BST key is released the display again shows the same number as it did before g BST was pressed: no instruction in program memory is executed.

Interrupting Program Execution

Occasionally you'll want a program to stop executing so that you can see an intermediate result or enter new data. The hp 12c platinum provides two functions for doing so: $\boxed{9}$ PSE (pause) and R/S (run/stop).

Pausing During Program Execution

When a running program executes a $\boxed{9}$ PSE instruction, program execution halts for about 1 second, then resumes. During the pause, the calculator displays the last result calculated before the $\boxed{9}$ PSE instruction was executed.

If you press any key during a pause, program execution is halted indefinitely. To resume program execution at the program line following that containing the $\boxed{9}$ PSE instruction, press R/S.

Example: Create a program that calculates the entries in the AMOUNT, TAX, and TOTAL columns for each item on the jewelry distributor's invoice shown on the next page, and also calculates the total in each of these columns for all items on the invoice. Assume the sales tax is 6.75%.

To conserve lines of program memory, instead of keying in the tax rate before the $\boxed{\%}$ instruction we'll store it in register R_0 and recall it before the $\boxed{\%}$ instruction. Before storing the program in program memory, we'll calculate the required amounts for the first item on the invoice manually. The keystroke sequence will use storage register arithmetic (described on page 29) in registers R_1 , R_2 , and R_3 to calculate the column sums. Since these registers are cleared when \boxed{f} CLEAR $\boxed{\Sigma}$ is pressed, we'll press those keys before beginning the manual calculation — and also later, before running the program — to ensure that the column sums are "initialized" to zero. (Pressing \boxed{f} CLEAR \boxed{REG} would clear registers R_1 through R_3 , but would also clear R_0 , which will contain the tax rate.)

120 Section 8: Programming Basics

DIRECT FORM PURCHASE REQUISITION ORDER
P.O. No. 25-

**RASTON, UNGER, BENTZ & YATES
JEWELERS**

2561 N.W. Morrison Ave.
New York, New York, 14203
Telephone (716) 731 - 8240

| ORDER DATE | CONFIRMING | SHIP VIA: SURFACE <input type="checkbox"/> AIR <input type="checkbox"/> UPS <input type="checkbox"/> | | | | |
|------------|------------|--|------------|--------|-----------|-------|
| | | VENDOR <input type="checkbox"/> WILL CALL <input type="checkbox"/> OTHER <input type="checkbox"/> | | | | |
| ITEM | QTY. | DESCRIPTION | UNIT PRICE | AMOUNT | TAX 6.75% | TOTAL |
| 1 | 13 | SS4 Star Sapphire | \$68.50 | ? | ? | ? |
| 2 | 18 | RG13 Ruby Ring | 72.90 | ? | ? | ? |
| 3 | 24 | GB87 Gold Band | 85.00 | ? | ? | ? |
| 4 | 5 | DG163 Diamond | 345.00 | ? | ? | ? |
| 5 | | | | | | |

Pressing the $\boxed{9}$ \boxed{PSE} keys is not necessary when we do the calculations manually, since in Run mode the result of every intermediate calculation is displayed automatically; but we'll include $\boxed{9}$ \boxed{PSE} instructions in the program so that the intermediate results AMOUNT and TAX are automatically displayed when the program is executed.

Keystrokes (RPN mode)

Display

6.75 \boxed{STO} 0

6.75

Stores tax rate in R_0 .

\boxed{f} \boxed{CLEAR} $\boxed{\Sigma}$

0.00

Clears the registers in R_1 through R_6 .

13

13.

Keys in quantity of item.

\boxed{ENTER}

13.00

Separates quantity of item from cost of item to be keyed in next.

68.5

68.5

Keys in cost of item.

**Keystrokes
(RPN mode)**

| Keystrokes (RPN mode) | Display | |
|-----------------------------------|---------|--|
| \boxed{X} | 890.50 | AMOUNT. |
| $\boxed{STO} \boxed{+} \boxed{1}$ | 890.50 | Adds AMOUNT to sum of AMOUNT entries in register R_1 . |
| $\boxed{RCL} \boxed{0}$ | 6.75 | Recalls tax rate to display. |
| $\boxed{\%}$ | 60.11 | TAX. |
| $\boxed{STO} \boxed{+} \boxed{2}$ | 60.11 | Adds TAX to sum of TAX entries in register R_2 . |
| $\boxed{+}$ | 950.61 | TOTAL. |
| $\boxed{STO} \boxed{+} \boxed{3}$ | 950.61 | Adds TOTAL to sum of TOTAL entries in register R_3 . |

**Keystrokes
(ALG mode)**

| Keystrokes (ALG mode) | Display | |
|--|---------|---|
| 6.75 $\boxed{STO} \boxed{0}$ | 6.75 | Stores tax rate in R_0 . |
| $\boxed{f} \boxed{CLEAR} \boxed{\Sigma}$ | 0.00 | Clears the registers in R_1 through R_6 . |
| 13 | 13. | Keys in quantity of item. |
| \boxed{X} | 13.00 | Separates quantity of item from cost of item to be keyed in next. |
| 68.5 | 68.5 | Keys in cost of item. |
| $\boxed{=}$ | 890.50 | AMOUNT. |
| $\boxed{STO} \boxed{+} \boxed{1}$ | 890.50 | Adds AMOUNT to sum of AMOUNT entries in register R_1 . |
| $\boxed{+}$ | 890.50 | Prepares to add tax. |
| $\boxed{RCL} \boxed{0}$ | 6.75 | Recalls tax rate to display. |
| $\boxed{\%}$ | 60.11 | TAX. |
| $\boxed{STO} \boxed{+} \boxed{2}$ | 60.11 | Adds TAX to sum of TAX entries in register R_2 . |
| $\boxed{=}$ | 950.61 | TOTAL. |
| $\boxed{STO} \boxed{+} \boxed{3}$ | 950.61 | Adds TOTAL to sum of TOTAL entries in register R_3 . |

122 Section 8: Programming Basics

Now, we'll store the program in program memory. Do not key in the quantity and cost of each item; these numbers will vary each time the program is run.

Keystrokes (RPN mode)

f **P/R**

Sets calculator to Program mode.

f **CLEAR** **PRGM**

000,

Clears program memory.

X

001, 20

g **PSE**

002, 43 31 Pauses to display AMOUNT.

STO **+** 1

003, 44 40 1

RCL 0

004, 45 0

%

005, 25

g **PSE**

006, 43 31 Pauses to display TAX.

STO **+** 2

007, 44 40 2

+

008, 40

STO **+** 3

009, 44 40 3

Keystrokes (ALG mode)

f **P/R**

Sets calculator to Program mode.

f **CLEAR** **PRGM**

000,

Clears program memory.

X

001, 20

X \rightarrow Y

002, 34

=

003, 36

g **PSE**

004, 43 31 Pauses to display AMOUNT.

STO **+** 1

005, 44 40 1

+

006, 40

RCL 0

007, 45 0

%

008, 25

g **PSE**

009, 43 31 Pauses to display TAX.

STO **+** 2

010, 44 40 2

=

011, 36

**Keystrokes
(ALG mode)****Display**STO $\boxed{+}$ 3

012, 44 40 3

Note: The procedure used in the ALG program in steps 1 through 3 allows the algebraic program to run in the same manner as the RPN version. In the instructions below, the $\boxed{\text{ENTER}}$ key is the same as the $\boxed{=}$ key in ALG mode. Now, to run the program, first set the appropriate mode by pressing \boxed{f} $\boxed{\text{RPN}}$ or \boxed{f} $\boxed{\text{ALG}}$ and then do the following:

Keystrokes**Display** \boxed{f} $\boxed{\text{P/R}}$

950.61

Sets calculator to Run mode.

 \boxed{f} $\boxed{\text{CLEAR}}$ $\boxed{\Sigma}$

0.00

Clears registers $R_1 - R_6$.6.75 $\boxed{\text{STO}}$ 0

Stores tax rate.

13 $\boxed{\text{ENTER}}$ 68.5

68.5

Enters quantity and price of first item on invoice.

 $\boxed{\text{R/S}}$

890.50

AMOUNT for first item.

60.11

TAX for first item.

950.61

TOTAL for first item.

18 $\boxed{\text{ENTER}}$ 72.9

72.9

Enters quantity and price of second item on invoice.

 $\boxed{\text{R/S}}$

1,312.20

AMOUNT for second item.

88.57

TAX for second item.

1,400.77

TOTAL for second item.

24 $\boxed{\text{ENTER}}$ 85

85.

Enters quantity and price of third item on invoice.

 $\boxed{\text{R/S}}$

2,040.00

AMOUNT for third item.

137.70

TAX for third item.

2,177.70

TOTAL for third item.

5 $\boxed{\text{ENTER}}$ 345

345.

Enters quantity and price of fourth item on invoice.

 $\boxed{\text{R/S}}$

1,725.00

AMOUNT for fourth item.

116.44

TAX for fourth item.

1,841.44

TOTAL for fourth item.

 $\boxed{\text{RCL}}$ 1

5,967.70

Sum of AMOUNT column.

124 Section 8: Programming Basics

| Keystrokes | Display | |
|-------------------------------|----------|----------------------|
| $\boxed{\text{RCL}}\boxed{2}$ | 402.82 | Sum of TAX column. |
| $\boxed{\text{RCL}}\boxed{3}$ | 6,370.52 | Sum of TOTAL column. |

If the duration of the pause is not long enough to write down the number displayed, you can prolong it by using more than one $\boxed{9}\boxed{\text{PSE}}$ instruction. Alternatively, you can have the program automatically *stop* as described next.

Stopping Program Execution

Stopping Program Execution Automatically. Program execution is automatically halted when the program executes a $\boxed{\text{R/S}}$ instruction. To resume executing the program from the program line at which execution was halted, press $\boxed{\text{R/S}}$.

Example: Replace the program above by one containing $\boxed{\text{R/S}}$ instructions instead of $\boxed{9}\boxed{\text{PSE}}$ instructions.

| Keystrokes (RPN mode) | Display | |
|---|---------|---|
| $\boxed{\text{f}}\boxed{\text{P/R}}$ | | Sets calculator to Program mode. |
| $\boxed{\text{f}}\boxed{\text{CLEAR}}\boxed{\text{PRGM}}$ | 000, | Clears program memory. |
| $\boxed{\text{X}}$ | 001, | 20 |
| $\boxed{\text{R/S}}$ | 002, | 31 Stops program execution to display AMOUNT. |
| $\boxed{\text{STO}}\boxed{+}\boxed{1}$ | 003,44 | 40 1 |
| $\boxed{\text{RCL}}\boxed{0}$ | 004, | 45 0 |
| $\boxed{\%}$ | 005, | 25 |
| $\boxed{\text{R/S}}$ | 006, | 31 Stops program execution to display TAX. |
| $\boxed{\text{STO}}\boxed{+}\boxed{2}$ | 007,44 | 40 2 |
| $\boxed{+}$ | 008, | 40 |
| $\boxed{\text{STO}}\boxed{+}\boxed{3}$ | 009,44 | 40 3 |

| Keystrokes (ALG mode) | Display | |
|---|---------|----------------------------------|
| $\boxed{\text{f}}\boxed{\text{P/R}}$ | | Sets calculator to Program mode. |
| $\boxed{\text{f}}\boxed{\text{CLEAR}}\boxed{\text{PRGM}}$ | 000, | Clears program memory. |

| Keystrokes (ALG mode) | Display | |
|---------------------------|-------------|----|
| \boxed{X} | 001 , | 20 |
| $\boxed{X \div y}$ | 002 , | 34 |
| $\boxed{=}$ | 003 , | 36 |
| $\boxed{R/S}$ | 004 , | 31 |
| $\boxed{STO} \boxed{+} 1$ | 005 , 44 40 | 1 |
| $\boxed{+}$ | 006 , | 40 |
| $\boxed{RCL} 0$ | 007 , 45 | 0 |
| $\boxed{\%}$ | 008 , | 25 |
| $\boxed{R/S}$ | 009 , | 31 |
| $\boxed{STO} \boxed{+} 2$ | 010 , 44 40 | 2 |
| $\boxed{=}$ | 011 , | 36 |
| $\boxed{STO} \boxed{+} 3$ | 012 , 44 40 | 3 |

Stops program execution to display AMOUNT.

Stops program execution to display TAX.

Now, to run the program, first set the appropriate mode by pressing $\boxed{f} \boxed{RPN}$ or $\boxed{f} \boxed{ALG}$ and then do the following:

| Keystrokes | Display | |
|--|----------|--|
| $\boxed{f} \boxed{P/R}$ | 6,370.52 | Sets calculator to Run mode. |
| $\boxed{f} \boxed{CLEAR} \boxed{\Sigma}$ | 0.00 | Clears registers R_1 through R_6 . |
| 13 \boxed{ENTER} 68.5 | 68.5 | First item. |
| $\boxed{R/S}$ | 890.50 | AMOUNT for first item. |
| $\boxed{R/S}$ | 60.11 | TAX for first item. |
| $\boxed{R/S}$ | 950.61 | TOTAL for first item. |
| 18 \boxed{ENTER} 72.9 | 72.9 | Second item. |
| $\boxed{R/S}$ | 1,312.20 | AMOUNT for second item. |
| $\boxed{R/S}$ | 88.57 | TAX for second item. |
| $\boxed{R/S}$ | 1,400.77 | TOTAL for second item. |
| 24 \boxed{ENTER} 85 | 85. | Third item. |
| $\boxed{R/S}$ | 2,040.00 | AMOUNT for third item. |

| Keystrokes | Display | |
|-----------------------|----------|-------------------------|
| $\boxed{R/S}$ | 137.70 | TAX for third item. |
| $\boxed{R/S}$ | 2,177.70 | TOTAL for third item. |
| 5 \boxed{ENTER} 345 | 345. | Fourth item. |
| $\boxed{R/S}$ | 1,725.00 | AMOUNT for fourth item. |
| $\boxed{R/S}$ | 116.44 | TAX for fourth item. |
| $\boxed{R/S}$ | 1,841.44 | TOTAL for fourth item. |
| $\boxed{RCL} 1$ | 5,967.70 | Sum of AMOUNT column. |
| $\boxed{RCL} 2$ | 402.82 | Sum of TAX column. |
| $\boxed{RCL} 3$ | 6,370.52 | Sum of TOTAL column. |

Program execution is also automatically halted when the calculator overflows (refer to page 89) or attempts an improper operation that results in an **Error** display. Either of these conditions signifies that the program itself probably contains an error.

To determine at which program line execution has halted (in order to locate the error), press any key to clear the **Error** display, then press $\boxed{f} \boxed{P/R}$ to set the calculator to Program mode and display that program line.

You may also want to display the current program line (by pressing $\boxed{f} \boxed{P/R}$) if your program has halted at one of several $\boxed{R/S}$ instructions in your program and you want to determine which one that is. To continue executing the program afterward:

1. Press $\boxed{f} \boxed{P/R}$ to set the calculator back to Run mode.
2. If you want to resume execution from the program line at which execution halted rather than from line 000, press $\boxed{g} \boxed{GTO}$ followed by three digit keys that specify the program line desired.
3. Press $\boxed{R/S}$ to resume execution.

Stopping Program Execution Manually. Pressing any key while a program is running halts program execution. You may want to do this if the calculated results displayed by a running program appear to be incorrect (indicating that the program itself is incorrect).

To halt program execution during a pause in a running program (that is, when $\boxed{g} \boxed{PSE}$ is executed), press any key.

After stopping program execution manually, you can determine at which program line execution has halted and/or resume program execution as described above.

Section 9

Branching and Looping

Although the instructions in a program normally are executed in order of their program line numbers, in some situations it is desirable to have program execution transfer or “branch” to a program line that is not the next line in program memory. Branching also makes it possible to automatically execute portions of a program more than once — a process called “looping.”

Simple Branching

The `GTO` (*go to*) instruction is used in a program to transfer execution to any program line. The program line desired is specified by keying its three-digit line number into the program line containing the `GTO` instruction. When the `GTO` instruction is executed, program execution branches or “goes to” the program line specified and then continues sequentially as usual.

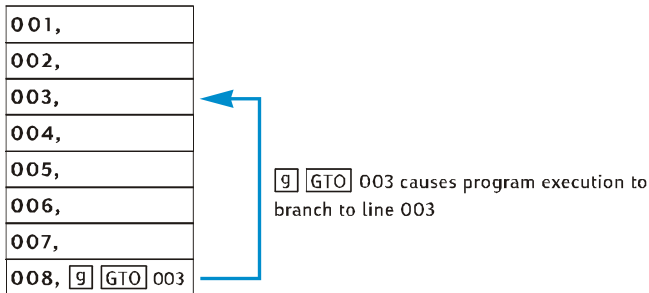

You have already seen a common use of branching: the `GTO` 000 instruction (that is stored in program memory after the program you key in) transfers execution to program line 000. A `GTO` instruction can be used to branch not only backward in program memory — as in the case of `GTO` 000 and as illustrated above — but also forward in program memory. Backward branching is typically done to create loops (as described next); forward branching is typically done in conjunction with a `X<Y` or `X=0` instruction for conditional branching (as described afterward).

Looping

If a **GTO** instruction specifies a lower-numbered line in program memory, the instructions in the program lines between the specified line and the **GTO** instruction will be executed repeatedly. As can be seen in the illustration above under Simple Branching, once the program begins executing the “loop” it will execute it again and again.

If you want to terminate the execution of a loop, you can include a **G X<Y** or **G X=0** instruction (described below) or an **R/S** instruction within the loop. You can also terminate execution by pressing any key while the loop is being executed.

Example: The following program automatically amortizes the payments on a home mortgage without requiring you to press **f AMORT** for each payment. It will amortize one month’s payments each time or one year’s payments each time the loop is executed, depending on whether the number 1 or 12 is in the display when you start running the program. Before running the program, we’ll “initialize” it by storing the required data in the financial registers — just as we would do if we were amortizing a single payment manually. We’ll run the program for a \$150,000 mortgage at 4.75% for 30 years, and we’ll key 1 into the display just before running it in order to amortize monthly payments. For the first two “passes” through the loop we’ll execute the program one line at a time, using **SST**, so that we can see the looping occurring; then we’ll use **R/S** to execute the entire loop a third time before terminating execution.

| Keystrokes | Display | |
|---------------------|--------------------------|---|
| f P/R | | Sets calculator to Program mode. |
| f CLEAR PRGM | 000 , | Clears program memory |
| STO 0 | 001 , 44 0 | Stores the number from the display into register R ₀ . This number will be the number of payments to be amortized. |
| RCL 0 | 002 , 45 0 | Recalls the number of payments to be amortized. This program line is the one to which program execution will later branch. It is included because after the first time the loop is executed, the number in the “display”* is replaced by the result of f AMORT . |

* More precisely, the number in the X-register.

| Keystrokes | Display | |
|--|---------------------|--|
| <code>f</code> <code>AMORT</code> | 003 , | 42 11 Amortizes payment(s). |
| <code>g</code> <code>PSE</code> | 004 , | 43 31 Pauses to display amount of payment(s) applied to interest. |
| <code>X\approxY</code> | 005 , | 34 Brings amount of payment(s) applied to principal into "display."* |
| <code>g</code> <code>PSE</code> | 006 , | 43 31 Pauses to display amount of payment(s) applied to principal. |
| <code>g</code> <code>GTO</code> 002 | 007 , 43 , 33 , 002 | Transfers program execution to line 002, so that the number of payments to be amortized can be recalled to the display before the <code>f</code> <code>AMORT</code> instruction in line 003 is executed. |
| <code>f</code> <code>P/R</code> | 0.00 | Sets calculator to Run mode. (Display shown assumes no results remain from previous calculations.) |
| <code>f</code> <code>CLEAR</code> <code>FIN</code> | 0.00 | Clears financial registers. |
| 30 <code>g</code> <code>12X</code> | 360.00 | Enters <i>n</i> . |
| 4.75 <code>g</code> <code>12\div</code> | 0.40 | Enters <i>i</i> . |
| 150000 <code>PV</code> | 150,000.00 | Enters <i>PV</i> . |
| <code>g</code> <code>END</code> | 150,000.00 | Sets payment to End. |
| <code>PMT</code> | -782.47 | Calculates the monthly payment. |
| 0 <code>n</code> | 0.00 | Reset <i>n</i> to zero. |
| 1 | 1. | Keys 1 into the display to amortize monthly payments. |
| <code>SST</code> | 001 , | 44 0 Line 001: <code>STO</code> 0. |
| | 1.00 | |
| <code>SST</code> | 002 , | 45 0 Line 002: <code>RCL</code> 0. This is the beginning of the first pass through the loop. |
| | 1.00 | |
| <code>SST</code> | 003 , | 42 11 Line 003: <code>f</code> <code>AMORT</code> . |

130 Section 9: Branching and Looping

Keystrokes

Display

| | | | |
|-------|------------------|--|---|
| | -593.75 | | Portion of first month's payment applied to interest. |
| [SST] | 004, 43 31 | | Line 004: [g][PSE]. |
| | -593.75 | | |
| [SST] | 005, 34 | | Line 005: [X][Y]. |
| | -188.72 | | Portion of first month's payment applied to principal. |
| [SST] | 006, 43 31 | | Line 006: [g][PSE]. |
| | -188.72 | | |
| [SST] | 007, 43, 33, 002 | | Line 007: [g][GTO]002. This is the end of the first pass through the loop. |
| | -188.72 | | |
| [SST] | 002, 45 0 | | Line 002: [RCL]0. Program execution has branched to the beginning of the loop for the second pass through it. |
| | 1.00 | | |
| [SST] | 003, 42 11 | | Line 003: [f][AMORT]. |
| | -593.00 | | Portion of second month's payment applied to interest. |
| [SST] | 004, 43 31 | | Line 004: [g][PSE]. |
| | -593.00 | | |
| [SST] | 005, 34 | | Line 005: [X][Y]. |
| | -189.47 | | Portion of second month's payment applied to principal. |
| [SST] | 006, 43 31 | | Line 006: [g][PSE]. |
| | -189.47 | | |
| [SST] | 007, 43, 33, 002 | | Line 007: [g][GTO]002. This is the end of the second pass through the loop. |
| | -189.47 | | |

| Keystrokes | Display | |
|-------------------------|---------|--|
| R/S | -592.25 | Portion of third month's payment applied to interest. |
| | -190.22 | Portion of third month's payment applied to principal. |
| R/S (or any key) | -190.22 | Halts program execution. |

Conditional Branching

Often there are situations when it is desirable for a program to be able to branch to different lines in program memory, depending on certain conditions. For example, a program used by an accountant to calculate taxes might need to branch to different program lines depending on the tax rate for the particular income level.

The hp 12c platinum provides two *conditional* test instructions that are used in programs for conditional branching:

- **g** **x<y** tests whether the number in the X-register (represented by the *x* in the key symbol) is less than or equal to the number in the Y-register (represented by the *y* in the key symbol). As discussed in Appendix A, the number in the X-register is simply the number that would, if the calculator were in Run mode, be currently in the display; and the number in the Y-register is the number that would, if the calculator were in Run mode, have been in the display when **ENTER** was pressed. For example, pressing **4****ENTER****5** would place the number 4 in the Y-register and the number 5 in the X-register.
- **g** **x=0** tests whether the number in the X-register is equal to zero.

The possible results of executing either of these instructions are:

- If the condition tested for is true when the instruction is executed, program execution continues sequentially with the instruction in the next line of program memory.
- If the condition tested for is false when the instruction is executed, program execution skips the instruction in the next line of program memory and continues with the instruction in the following line.

132 Section 9: Branching and Looping

These rules can be summarized as “DO if TRUE”.

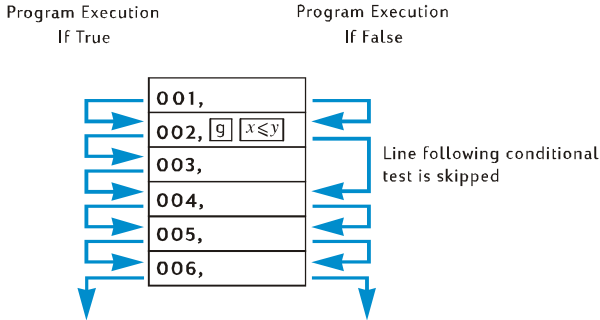

The program line immediately following that containing the conditional test instruction can contain any instruction; however, the most commonly used instruction there is `GTO`. If a `GTO` instruction follows a conditional test instruction, program execution branches elsewhere in program memory if the condition is true and continues with the next line in program memory if the condition is false.

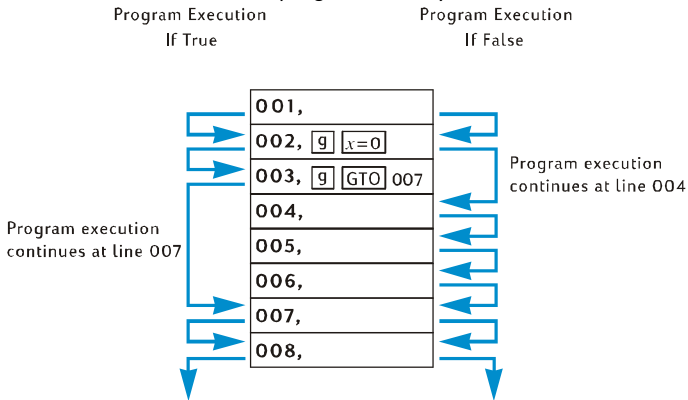

Example: The following program calculates income tax at a rate of 20% on incomes of \$20,000 or less and 25% on incomes of more than \$20,000. To conserve program lines, the program assumes that the test value — 20,000 — has been stored in register R_0 and the tax rates — 20 and 25 — have been stored in registers R_1 and R_2 , respectively.

Note: If a program requires that certain numbers be in the X- and Y-registers when instructions such as `g | x < y` are executed, it is extremely helpful when writing the program to show the quantities in each register after each instruction is executed, as in the following diagram (which shows an RPN mode program, although it works in a similar way in ALG mode.).

| | | | | | |
|-----|--------|--------|--------|--------|--------|
| Y → | 0 | income | 20,000 | 20,000 | 20,000 |
| X → | income | 20,000 | income | income | income |

| | | | | | |
|--------|--------|------------------------|--------------------|--------------------|--------------------------|
| Keys → | income | $\boxed{\text{RCL}} 0$ | $\boxed{x \geq y}$ | $\boxed{x \leq y}$ | $\boxed{\text{GTO}} 007$ |
| Line → | | 001 | 002 | 003 | 004 |

| | | | | |
|-----|--------|--------|--------|--------|
| Y → | income | income | income | income |
| X → | 25.00 | 25.00 | 20.00 | tax |

| | | | | |
|--------|------------------------|--------------------------|------------------------|--------------|
| Keys → | $\boxed{\text{RCL}} 2$ | $\boxed{\text{GTO}} 008$ | $\boxed{\text{RCL}} 1$ | $\boxed{\%}$ |
| Line → | 005 | 006 | 007 | 008 |

RPN program notes: We'll key the income into the display before running the program so that it will be in the X-register when the $\boxed{\text{RCL}} 0$ instruction in program line 001 is executed. This instruction will place the test value 20,000 in the X-register and (as explained in Appendix A) move the income into the Y-register. The $\boxed{x \geq y}$ instruction in program line 002 will exchange the numbers in the X- and Y-registers (as also explained in Appendix A): that is, it will place the income back into the X-register and place the test value into the Y-register. This is necessary because when either the $\boxed{\text{RCL}} 2$ instruction in line 005 or the $\boxed{\text{RCL}} 1$ instruction in line 007 is executed, the number in the X-register is moved into the Y-register; if the $\boxed{x \geq y}$ instruction were not included, the test value 20,000, rather than the income, would be in the Y-register when the $\boxed{\%}$ instruction in line 008 is executed.

**Keystrokes
(RPN mode)**

Display

| | | | | |
|---|------------------|----|--|--|
| $\boxed{\text{f}} \boxed{\text{RPN}}$ | | | | |
| $\boxed{\text{f}} \boxed{\text{P/R}}$ | 007, 43, 33, 002 | | | Sets calculator to Program mode. (Display shows program line at which execution was halted at end of preceding example.) |
| $\boxed{\text{f}} \boxed{\text{CLEAR}} \boxed{\text{PRGM}}$ | 000, | | | Clears program memory. |
| $\boxed{\text{RCL}} 0$ | 001, 45 | 0 | | Recalls test value into X-register and places income in Y-register. |
| $\boxed{x \geq y}$ | 002, | 34 | | Places income in X-register and test value in Y-register. |

134 Section 9: Branching and Looping

Keystrokes (RPN mode)

Display

| | | |
|-------------------------------------|------------------|---|
| <code>g</code> <code>X<Y</code> | 003, 43 34 | Tests whether number in X-register (income) is less than or equal to number in Y-register (20,000). |
| <code>g</code> <code>GTO</code> 007 | 004, 43, 33, 007 | If condition is true, branches to program line 007. |
| <code>RCL</code> 2 | 005, 45 2 | If condition is false, recalls 25% tax rate to X-register. |
| <code>g</code> <code>GTO</code> 008 | 006, 43, 33, 008 | Branches to program line 008. |
| <code>RCL</code> 1 | 007, 45 1 | Recalls 20% tax rate to X-register. |
| <code>%</code> | 008, 25 | Calculates tax. |
| <code>f</code> <code>P/R</code> | -190.22 | Sets calculator to Run mode. (Display shows results of running of previous program.) |

ALG program notes: We'll key the income into the display before running the program. We'll store it in R_0 , so it will be available for the examples in the next chapter. By keying the income into the display before running the program, we ensure that it will be in the X-register when the `RCL`0 instruction in program line 002 is executed. This instruction will place the test value 20,000 in the X-register and move the income into the Y-register. The `X<Y` instruction in program line 003 will exchange the numbers in the X- and Y-registers: that is, it will place the income back into the X-register and place the test value into the Y-register. This is necessary because when either the `RCL`2 instruction in line 007 or the `RCL`1 instruction in line 009 is executed, the number in the X-register is moved into the Y-register; if the `X<Y` instruction were not included, the test value 20,000, rather than the income, would be in the Y-register when the `%` instruction in line 010 is executed.

Keystrokes (ALG mode)

Display

| | | |
|---|------------------|---|
| <code>f</code> <code>ALG</code> | | |
| <code>f</code> <code>P/R</code> | 007, 43, 33, 002 | Sets calculator to Program mode. (Display shows program line at which execution was halted at end of preceding example.) |
| <code>f</code> <code>CLEAR</code> <code>PRGM</code> | 000, | Clears program memory. |
| <code>STO</code> 9 | 001, 44 9 | Stores income into register R_9 . |

| Keystrokes (ALG mode) | Display | | | | |
|--|-----------|------|------|---|---|
| $\boxed{\text{RCL}}\boxed{0}$ | 002 , | 45 | 0 | Recalls test value into X-register and places income in Y-register. | |
| $\boxed{\text{X}}\boxed{\text{Y}}$ | 003 , | | 34 | Places income in X-register and test value in Y-register. | |
| $\boxed{\text{X}}$ | 004 , | | 20 | Prepares for multiplication. | |
| $\boxed{\text{G}}\boxed{\text{X}}\boxed{\text{Y}}$ | 005 , | 43 | 34 | Tests whether number in X-register (income) is less than or equal to number in Y-register (20,000). | |
| $\boxed{\text{G}}\boxed{\text{GTO}}\boxed{009}$ | 006 , | 43 , | 33 , | 009 | If condition is true, branches to program line 009. |
| $\boxed{\text{RCL}}\boxed{2}$ | 007 , | 45 | 2 | If condition is false, recalls 25% tax rate to X-register. | |
| $\boxed{\text{G}}\boxed{\text{GTO}}\boxed{010}$ | 008 , | 43 , | 33 , | 010 | Branches to program line 010. |
| $\boxed{\text{RCL}}\boxed{1}$ | 009 , | 45 | 1 | Recalls 20% tax rate to X-register. | |
| $\boxed{\%}$ | 010 , | | 25 | Divides tax rate by 100. | |
| $\boxed{=}$ | 011 , | | 36 | Calculates tax. | |
| $\boxed{\text{f}}\boxed{\text{P/R}}$ | -190 . 22 | | | Sets calculator to Run mode. (Display shows results of running of previous program.) | |

Now, we'll store the required numbers in registers R_0 , R_1 , and R_2 , then we'll run the program, using $\boxed{\text{SST}}$ so that we can check that the branching occurs properly. It's good practice with programs containing conditional test instructions to check that the program branches correctly for all possible conditions: in this case, if the income is less than, equal to, or greater than the test value.

| Keystrokes (RPN mode) | Display | | | |
|-------------------------------------|---------------|----|---|---|
| 20000 $\boxed{\text{STO}}\boxed{0}$ | 20 , 000 . 00 | | | Stores test value in register R_0 . |
| 20 $\boxed{\text{STO}}\boxed{1}$ | 20 . 00 | | | Stores 20% tax rate in register R_1 . |
| 25 $\boxed{\text{STO}}\boxed{2}$ | 25 . 00 | | | Stores 25% tax rate in register R_2 . |
| 15000 | 15 , 000 . | | | Keys income less than test value into display and X-register. |
| $\boxed{\text{SST}}$ | 001 , | 45 | 0 | Line 001: $\boxed{\text{RCL}}\boxed{0}$. |

136 Section 9: Branching and Looping

Keystrokes (RPN mode)

Display

| | | | |
|-------|---------------|----|--|
| | 20,000.00 | | Test value has been recalled to X-register, moving income to Y-register. |
| [SST] | 002, | 34 | Line 002: [X≧Y] |
| | 15,000.00 | | Income has been placed in X-register and test value has been placed in Y-register. |
| [SST] | 003, | 43 | 34 Line 003: [g][X<Y] |
| | 15,000.00 | | |
| [SST] | 004,43,33,007 | | Condition tested by [X<Y] was true, so program execution continued with line 004: [g][GTO]007. |
| | 15,000.00 | | |
| [SST] | 007, | 45 | 1 Line 007: [RCL]1. |
| | 20.00 | | 20% tax rate has been recalled to X-register, moving income to Y-register. |
| [SST] | 008, | 25 | Line 008: [%]. |
| | 3,000.00 | | 20% of 15,000 = 3,000. |
| 20000 | 20,000. | | Keys income equal to test value into display and X-register. |
| [SST] | 001, | 45 | 0 Line 001: [RCL]0. |
| | 20,000.00 | | Test value has been recalled to X-register, moving income to Y-register. |
| [SST] | 002, | 34 | Line 002: [X≧Y]. |
| | 20,000.00 | | Income has been placed in X-register and test value has been placed in Y-register. |
| [SST] | 003, | 43 | 34 Line 003 [g][X<Y]. |
| | 20,000.00 | | |

**Keystrokes
(RPN mode)**

Display

| | | | |
|-------|------------------|-----------|--|
| [SST] | 004, 43, 33, 007 | 004 | Condition tested by [X<Y] was true, so program execution continued with line 004: [G]GTO007. |
| | | 20,000.00 | |
| [SST] | 007, 45 | 007 | 1 Line 007: [RCL]1. |
| | | 20.00 | 20% tax rate has been recalled to X-register, moving income to Y-register. |
| [SST] | 008, 25 | 008 | Line 008: [%]. |
| | | 4,000.00 | 20% of 20,000 = 4,000. |
| 25000 | | 25,000. | Keys income greater than test value into display and X-register. |
| [SST] | 001, 45 | 001 | 0 Line 001: [RCL]0. |
| | | 20,000.00 | Test value has been recalled to X-register, moving income to Y-register. |
| [SST] | 002, 34 | 002 | Line 002: [X<Y]. |
| | | 25,000.00 | Income has been placed in X-register and test value has been placed in Y-register. |
| [SST] | 003, 43 | 003 | 34 Line 003: [G]X<Y. |
| | | 25,000.00 | |
| [SST] | 005, 45 | 005 | 2 Condition tested by [X<Y] was false, so program execution skipped the next line and continued at line 005: [RCL]2. |
| | | 25.00 | 25% tax rate has been recalled to X-register, moving income to Y-register. |
| [SST] | 006, 43, 33, 008 | 006 | Line 006: [G]GTO008. |
| | | 25.00 | |
| [SST] | 008, 25 | 008 | Line 008: [%]. |
| | | 6,250.00 | 25% of 25,000 = 6,250. |

138 Section 9: Branching and Looping

Keystrokes (ALG mode)

Display

| | | |
|------------------------------|------------------|---|
| 20000 $\boxed{\text{STO}}$ 0 | 20,000.00 | Stores test value in register R ₀ . |
| 20 $\boxed{\text{STO}}$ 1 | 20.00 | Stores 20% tax rate in register R ₁ . |
| 25 $\boxed{\text{STO}}$ 2 | 25.00 | Stores 25% tax rate in register R ₂ . |
| 15000 | 15,000. | Keys income less than test value into display and X-register. |
| $\boxed{\text{SST}}$ | 001, 44 | 9 Line 001: $\boxed{\text{STO}}$ 9. |
| | 15,000.00 | Stores income into register R ₉ . |
| $\boxed{\text{SST}}$ | 002, 45 | 0 Line 002: $\boxed{\text{RCL}}$ 0. |
| | 20,000.00 | Test value has been recalled to X-register, moving income to Y-register. |
| $\boxed{\text{SST}}$ | 003, 34 | Line 003: $\boxed{\text{X}\leftrightarrow\text{Y}}$ |
| | 15,000.00 | Income has been placed in X-register and test value has been placed in Y-register. |
| $\boxed{\text{SST}}$ | 004, 20 | Line 004: $\boxed{\text{X}}$ |
| | 15,000.00 | |
| $\boxed{\text{SST}}$ | 005, 43 | 34 Line 005: $\boxed{\text{g}}$ $\boxed{\text{X}\leq\text{Y}}$ |
| | 15,000.00 | |
| $\boxed{\text{SST}}$ | 006, 43, 33, 009 | Condition tested by $\boxed{\text{X}\leq\text{Y}}$ was true, so program execution continued with line 006: $\boxed{\text{g}}$ $\boxed{\text{GTO}}$ 009. |
| | 15,000.00 | |
| $\boxed{\text{SST}}$ | 009, 45 | 1 Line 009: $\boxed{\text{RCL}}$ 1. |
| | 20.00 | 20% tax rate has been recalled to X-register, moving income to Y-register. |
| $\boxed{\text{SST}}$ | 010, 25 | Line 010: $\boxed{\%}$. |
| | 0.20 | Divides tax rate by 100. |
| $\boxed{\text{SST}}$ | 011, 36 | Line 011: $\boxed{=}$. |
| | 3,000.00 | 20% of 15,000 = 3,000. |

**Keystrokes
(ALG mode)**

Display

| | | |
|-------|----------------------------|---|
| [SST] | 012,43,33,000 3,000.00 | Line 012: [G][GTO]000. |
| 20000 | 20,000. | Keys income equal to test value into display and X-register. |
| [SST] | 001, 44 20,000.00 | 9 Line 001: [STO]9. Stores income into register R ₉ . |
| [SST] | 002, 45 20,000.00 | 0 Line 002: [RCL]0. Test value has been recalled to X-register, moving income to Y-register. |
| [SST] | 003, 20,000.00 | 34 Line 003: [X↔Y]. Income has been placed in X-register and test value has been placed in Y-register. |
| [SST] | 004, 20,000.00 | 20 Line 004: [X] |
| [SST] | 005, 43 20,000.00 | 34 Line 005: [G][X<Y]. |
| [SST] | 006,43,33,009 20,000.00 | Condition tested by [X<Y] was true, so program execution continued with line 006: [G][GTO]009. |
| [SST] | 009, 45 20.00 | 1 Line 009: [RCL]1. 20% tax rate has been recalled to X-register, moving income to Y-register. |
| [SST] | 010, 0.20 | 25 Line 010: [%]. Divides tax rate by 100. |
| [SST] | 011, 4,000.00 | 36 Line 011: [=]. 20% of 20,000 = 4,000. |
| [SST] | 012,43,33,000 4,000.00 | Line 012: [G][GTO]000. |

140 Section 9: Branching and Looping

Keystrokes (ALG mode)

Display

| | | | | |
|-------|-------|------------------|----|--|
| | 25000 | 25,000. | | Keys income greater than test value into display and X-register. |
| [SST] | | 001, 44 | 9 | Line 001: [STO]9. |
| | | 25,000.00 | | Stores income into register R ₉ . |
| [SST] | | 002, 45 | 0 | Line 002: [RCL]0. |
| | | 20,000.00 | | Test value has been recalled to X-register, moving income to Y-register. |
| [SST] | | 003, 34 | | Line 003: [X↔Y]. |
| | | 25,000.00 | | Income has been placed in X-register and test value has been placed in Y-register. |
| [SST] | | 004, 20 | | Line 004: [X]. |
| | | 25,000.00 | | |
| [SST] | | 005, 43 | 34 | Line 005: [g][X<Y]. |
| | | 25,000.00 | | |
| [SST] | | 007, 45 | 2 | Condition tested by [X<Y] was false, so program execution skipped the next line and continued at line 007: [RCL]2. |
| | | 25.00 | | 25% tax rate has been recalled to X-register, moving income to Y-register. |
| [SST] | | 008, 43, 33, 010 | | Line 008: [g][GTO]010. |
| | | 25.00 | | |
| [SST] | | 010, 25 | | Line 010: [%]. |
| | | 0.25 | | Divides tax rate by 100. |
| [SST] | | 011, 36 | | Line 011: [=]. |
| | | 6,250.00 | | 25% of 25,000 = 6,250. |

Section 10

Program Editing

There are various reasons why you might want to modify a program you have stored in Program memory: to correct a program that turns out to have errors; to insert new instructions such as $\boxed{\text{STO}}$ to store intermediate results or $\boxed{\text{PSE}}$ to display intermediate results; or to replace a $\boxed{\text{PSE}}$ instruction by an $\boxed{\text{R/S}}$ instruction.

Rather than clearing program memory and keying in the modified program, you can modify the program already stored in the calculator. This is called *program editing*.

Changing the Instruction in a Program Line

To change a single instruction in program memory:

1. Press $\boxed{\text{f}} \boxed{\text{P/R}}$ to set the calculator to Program mode.
2. Use $\boxed{\text{SST}}$, $\boxed{\text{BST}}$, or $\boxed{\text{GTO}} \boxed{\cdot}$ to set the calculator to the program line *preceding* the line containing the instruction to be changed.
3. Key in the new instruction.

For example, to change the instruction stored in program line 005, press $\boxed{\text{9}} \boxed{\text{GTO}} \boxed{\cdot} \boxed{004}$, then key in the new instruction that is to be stored in program line 005. The instruction previously stored in line 005 will be replaced; it is *not* automatically “bumped” into line 006.

Example: With the last program from the preceding section still stored in the calculator, suppose you wanted to use register R_2 for some other purpose, and so you needed to replace the $\boxed{\text{RCL}} \boxed{2}$ instruction in program line 005 in the RPN program (line 007 in the ALG program) with, say, $\boxed{\text{RCL}} \boxed{6}$. You could change the instruction in line 005 as follows:

| Keystrokes (RPN mode) | Display | |
|---|------------------|--|
| $\boxed{\text{f}} \boxed{\text{P/R}}$ | | Sets calculator to Program mode. |
| $\boxed{\text{9}} \boxed{\text{GTO}} \boxed{\cdot} \boxed{004}$ | 004, 43, 33, 007 | Sets calculator to program line preceding that containing the instruction to be changed. |
| $\boxed{\text{RCL}} \boxed{6}$ | 005, 45 6 | Keys new instruction into program line 005, replacing the $\boxed{\text{RCL}} \boxed{2}$ instruction previously there. |

**Keystrokes
(RPN mode)**

Display

| | | |
|--------------------------|---------------|--|
| <code>SST</code> | 006,43,33,008 | Shows that instruction in program line 006 has not been changed. |
| <code>f P/R</code> | 6,250.00 | Sets calculator back to Run mode. (Display shown assumes results remain from last example in preceding section.) |
| <code>RCL 2 STO 6</code> | 25.00 | Copies tax rate from R_2 into R_6 . |

**Keystrokes
(ALG mode)**

Display

| | | |
|--------------------------|---------------|--|
| <code>f P/R</code> | | Sets calculator to Program mode. |
| <code>g GTO 006</code> | 006,43,33,009 | Sets calculator to program line preceding that containing the instruction to be changed. |
| <code>RCL 6</code> | 007, 45 6 | Keys new instruction into program line 007, replacing the <code>RCL 2</code> instruction previously there. |
| <code>SST</code> | 008,43,33,010 | Shows that instruction in program line 008 has not been changed. |
| <code>f P/R</code> | 6,250.00 | Sets calculator back to Run mode. (Display shown assumes results remain from last example in preceding section.) |
| <code>RCL 2 STO 6</code> | 25.00 | Copies tax rate from R_2 into R_6 . |

Adding Instructions at the End of a Program

To add one or more instructions at the end of the last program stored in program memory:

1. Press `f P/R` to set the calculator to Program mode.
2. Press `g GTO 0` followed by three digits that specify the *last* line you keyed into program memory (that is, the highest numbered line, not necessarily the line most recently keyed in).
3. Key in the new instruction or instructions.

Note: To add one or more instructions at the end of a program that is not the *last* program stored in program memory, use the procedure described below under Adding Instructions within a Program.

Example: With the last program from the preceding section stored in the calculator, suppose you wanted to calculate the net income after taxes. In the RPN program, you could add a \square instruction at the end in order to calculate the net income after taxes. In the ALG program, the tax computed would need to be subtracted from the income previously stored in R_9 , (and this will be done by changing the sign of the tax to make it negative and then adding it to the income). You could do this as follows:

**Keystrokes
(RPN mode)**

| Keystrokes (RPN mode) | Display | | |
|---|---------------|----|--|
| \boxed{f} $\boxed{P/R}$ | | | Sets calculator to Program mode. |
| \boxed{g} \boxed{GTO} $\boxed{\cdot}$ 008 | 008 , | 25 | Sets calculator to last line keyed into program memory. |
| $\boxed{-}$ | 009 , | 30 | Keys new instruction into program line 009. |
| \boxed{f} $\boxed{P/R}$ | 25 . 00 | | Sets calculator back to Run mode. |
| 15000 $\boxed{R/S}$ | 12 , 000 . 00 | | Net income after 20% tax is subtracted from \$15,000 income. |

**Keystrokes
(ALG mode)**

| Keystrokes (ALG mode) | Display | | |
|---|---------|------|---|
| \boxed{f} $\boxed{P/R}$ | | | Sets calculator to Program mode. |
| \boxed{g} \boxed{GTO} $\boxed{\cdot}$ 011 | 011 , | 36 | Sets calculator to last line keyed into program memory. |
| \boxed{CHS} | 012 , | 16 | Keys new instruction into program line 012. |
| $\boxed{+}$ | 013 , | 40 | Keys new instruction into program line 013. |
| \boxed{RCL} 9 | 014 , | 45 9 | Keys new instruction into program line 014. |
| $\boxed{=}$ | 015 , | 36 | Keys new instruction into program line 015. |
| \boxed{f} $\boxed{P/R}$ | 25 . 00 | | Sets calculator back to Run mode. |

**Keystrokes
(ALG mode)**

Display

15000 $\boxed{R/S}$

12,000.00

Net income after 20% tax is subtracted from \$15,000 income.

Adding Instructions within a Program

If an instruction is to be added within a program, simply keying it in will replace the instruction previously stored in that program line, as described above; the contents of all higher-numbered program lines remain unchanged.

To add instructions within a program, you could simply key in the new instructions, beginning at the proper program line, followed by the original instructions from that program line through the end of the program. This method is described below under Adding Instructions by Replacement. When instructions must be added in the middle of a long program, however, using this method will require you to key in numerous instructions — namely, the original instructions from the point at which the new instructions are added through the end of program memory. Since keying in these instructions may require a significant amount of time, in such situations you may prefer to use the method described below under Adding Instructions by Branching.

That method basically involves branching to the new instructions which are stored at the end of program memory, then branching back to the program line immediately following the line from which you branched out. Adding instructions by branching is not so simple as adding instructions by replacement; however, it generally will require fewer keystrokes whenever there are more than four program lines between (and including) the first line to be executed after the new instruction(s) and the last line you keyed into program memory. Furthermore, if program memory includes branches to program lines following the point at which the new instruction(s) are being added, adding instructions by branching will *not* require that you change the line numbers specified in the \boxed{GTO} instructions, which *may* be necessary when you add instructions by replacement.

Adding Instructions by Replacement

1. Press $\boxed{f} \boxed{P/R}$ to set the calculator to Program mode.
2. Press $\boxed{9} \boxed{GTO} \boxed{\cdot}$ followed by three digits that specify the last program line to be executed before the added instruction(s). This sets the calculator to the proper program line for adding the new instruction(s) in the next step.
3. Key in the new instruction or instructions.

- Key in the original instruction or instructions, beginning with the first instruction to be executed *after* the added instruction(s), and continuing through the last instruction you keyed into program memory.

Note: If program memory includes branches to program lines following that at which the first new instruction is being added, remember to change the line number(s) specified in the **GTO** instruction(s) — as described above under Changing the Instruction in a Program Line — to the actual *new* line number(s).

Example: Assuming you have made the program modifications as in the preceding example, suppose you now wanted to insert a **R/S** instruction before the program calculates net income after tax so that the program will display the amount of the tax before displaying the net income after tax. The program should be modified by making the changes below:

| Keystrokes (RPN mode) | Display | | |
|----------------------------------|----------------|----|---|
| f P/R | | | Sets calculator to Program mode. |
| g GTO . 008 | 008 , | 25 | Sets calculator to last program line to be executed, which contains the % instruction. |
| R/S | 009 , | 31 | Keys in new instruction. |
| - | 010 , | 30 | Keys in original instruction, which was replaced by new instruction added. |
| f P/R | 12 , 000 . 00 | | Sets calculator back to Run mode. |
| 15000 R/S | 3 , 000 . 00 | | Twenty percent tax on \$15,000 income. |
| R/S | 12 , 000 . 00 | | Net income after tax. |

| Keystrokes (ALG mode) | Display | | |
|----------------------------------|----------------|----|--|
| f P/R | | | Sets calculator to Program mode. |
| g GTO . 011 | 011 , | 36 | Sets calculator to last line keyed into program memory for original program. |
| R/S | 012 , | 31 | Keys new instruction into program line 012. |

**Keystrokes
(ALG mode)**

Display

| | | | |
|---------------------|-----------|------|--|
| CHS | 013 , | 16 | Keys new instruction into program line 013. |
| + | 014 , | 40 | Keys new instruction into program line 014. |
| RCL 9 | 015 , | 45 9 | Keys new instruction into program line 015. |
| = | 016 , | 36 | Keys new instruction into program line 016. |
| f P/R | 12,000.00 | | Sets calculator back to Run mode. |
| 15000 R/S | 3,000.00 | | Twenty percent tax on \$15,000 income. |
| R/S | 12,000.00 | | Net income after 20% tax is subtracted from \$15,000 income. |

Adding Instructions by Branching

1. Press **f** **P/R** to set the calculator to Program mode.
2. Press **g** **GTO** **▀** followed by three digits that specify the program line immediately preceding the point at which the new instruction(s) are being added — usually, the last program line to be executed before the added instruction(s). This sets the calculator to the proper program line for inserting a **GTO** instruction in the next step. This **GTO** instruction will replace whatever instruction was already stored there, but that instruction will be keyed back into program memory, to be executed just after the new instructions, in step 7.
3. Press **g** **GTO** followed by three digits that specify the *second* line after the last line you keyed into program memory. (Branching to the *second* line rather than to the *first* is necessary because the first line following the last program in program memory must contain a **GTO**000 instruction. The **GTO**000 instruction ensures that program execution will branch to line 000 and halt after the program is run.) For example, if the last line you keyed into program memory was line 010, you would press **g** **GTO**012 at this step, preserving the **g** **GTO**000 in line 011.
4. Press **g** **GTO** **▀** followed by three digits that specify the last line you keyed into program memory.
5. Press **g** **GTO**000. This automatically converts a data storage register into seven additional lines of program memory (if there was not already a **g** **GTO**000 instruction remaining at the end of program memory), and it

ensures that program execution will branch to line 000 after the program is run.

6. Key in the instruction(s) being added.
7. Key in the instruction that originally immediately followed the point at which the new instruction(s) are being added — that is, the first instruction to be executed *after* the added instruction(s). (This instruction was replaced by the $\boxed{\text{GTO}}$ instruction keyed in at step 3.)
8. Press $\boxed{\text{g}}\boxed{\text{GTO}}$ followed by three digits that specify the *second* line following the point at which the new instruction(s) are being added. This $\boxed{\text{GTO}}$ instruction will cause program execution to branch back to the proper line within the original program.

Example: Continuing with the preceding example, suppose incomes less than or equal to \$7,500 were not to be taxed. You could modify the program to check for this condition and stop at line 000, displaying the original income keyed in, by storing 7,500 in register R_3 and adding the following instructions between lines 000 and 001 (the added lines are the same in RPN and ALG modes): $\boxed{\text{RCL}}\boxed{3}\boxed{\times}\boxed{y}\boxed{\text{g}}\boxed{\div}\boxed{x}\boxed{\leq}\boxed{y}\boxed{\text{g}}\boxed{\text{GTO}}\boxed{000}$. Since there are more than four instructions between (and including) the first line to be executed after the added instructions (line 001) and the last line you keyed into program memory (line 010 in RPN and line 016 in ALG), it will require fewer keystrokes to add the new instructions by branching than to add them by replacement.

**Keystrokes
(RPN mode)**

Display

$\boxed{\text{f}}\boxed{\text{P/R}}$

Sets calculator to Program mode.

$\boxed{\text{g}}\boxed{\text{GTO}}\boxed{\cdot}\boxed{000}$

000 ,

Sets calculator to program line immediately preceding point at which new instructions are being added. (In this particular example, this step could have been skipped since calculator was already set at the proper program line.)

$\boxed{\text{g}}\boxed{\text{GTO}}\boxed{012}$

001 , 43 , 33 , 012

Branches to program line 012, the second line after last line of program.

$\boxed{\text{g}}\boxed{\text{GTO}}\boxed{\cdot}\boxed{010}$

010 , 30

Sets calculator to last line of program so that the $\boxed{\text{g}}\boxed{\text{GTO}}\boxed{000}$ instruction keyed in next will be stored as the last line of the current program.

148 Section 10: Program Editing

Keystrokes (RPN mode)

Display

| | | |
|---|------------------|--|
| <code>g</code> <code>GTO</code> 000 | 011, 43, 33, 000 | Ends the current program with a <code>g</code> <code>GTO</code> 000. |
| <code>RCL</code> 3 | 012, 45 3 | } Added instructions. |
| <code>x</code> <code>z</code> <code>y</code> | 013, 34 | |
| <code>g</code> <code>x</code> <code>z</code> <code>y</code> | 014, 43 34 | |
| <code>g</code> <code>GTO</code> 000 | 015, 43, 33, 000 | |
| <code>RCL</code> 0 | 016, 45 0 | Keys in instruction immediately following point at which new instructions are being added. (This instruction was replaced in line 001 by <code>g</code> <code>GTO</code> 012 instruction.) |
| <code>g</code> <code>GTO</code> 002 | 017, 43, 33, 002 | Branches back to second line (line 002) following point at which new instructions are being added. |
| <code>f</code> <code>P/R</code> | 12, 000.00 | Sets calculator back to Run mode. |
| 7500 <code>STO</code> 3 | 7, 500.00 | Stores test value in register R ₃ . |
| 6500 <code>R/S</code> | 6, 500.00 | Runs program for income less than \$7,500. Display shows original income keyed in, indicating that tax is zero. |
| 15000 <code>R/S</code> | 3, 000.00 | Tax on \$15,000 income. |
| <code>R/S</code> | 12, 000.00 | Net income after tax. This shows program still works for an income greater than \$7,500 and less than \$20,000. |

**Keystrokes
(ALG mode)**

Display

| | | |
|---|---------------------|---|
| <code>f</code> <code>P/R</code> | | Sets calculator to Program mode. |
| <code>g</code> <code>GTO</code> <code>.</code> <code>000</code> | 000 , | Sets calculator to program line immediately preceding point at which new instructions are being added. (In this particular example, this step could have been skipped since calculator was already set at the proper program line.) |
| <code>g</code> <code>GTO</code> <code>018</code> | 001 , 43 , 33 , 018 | Branches to program line 018, the second line after last line of program. |
| <code>g</code> <code>GTO</code> <code>.</code> <code>016</code> | 016 , 36 | Sets calculator to last line of program so that the <code>g</code> <code>GTO</code> <code>000</code> instruction keyed in next will be stored as the last line of the current program. |
| <code>g</code> <code>GTO</code> <code>000</code> | 017 , 43 , 33 , 000 | Ends the current program with a <code>g</code> <code>GTO</code> <code>000</code> . |
| <code>RCL</code> <code>3</code> | 018 , 45 3 | } Added instructions. |
| <code>X\leftrightarrowY</code> | 019 , 34 | |
| <code>g</code> <code>X\leqY</code> | 020 , 43 34 | |
| <code>g</code> <code>GTO</code> <code>000</code> | 021 , 43 , 33 , 000 | |
| <code>STO</code> <code>9</code> | 022 , 44 9 | Keys in instruction immediately following point at which new instructions are being added. (This instruction was replaced in line 001 by <code>g</code> <code>GTO</code> <code>018</code> instruction.) |
| <code>g</code> <code>GTO</code> <code>002</code> | 023 , 43 , 33 , 002 | Branches back to second line (line 002) following point at which new instructions are being added. |
| <code>f</code> <code>P/R</code> | 12 , 000 . 00 | Sets calculator back to Run mode. |
| 7500 <code>STO</code> <code>3</code> | 7 , 500 . 00 | Stores test value in register R ₃ . |
| 6500 <code>R/S</code> | 6 , 500 . 00 | Runs program for income less than \$7,500. Display shows original income keyed in, indicating that tax is zero. |

150 Section 10: Program Editing

Keystrokes (ALG mode)

15000[R/S]

[R/S]

Display

3,000.00

12,000.00

Tax on \$15,000 income.

Net income after tax. This shows program still works for an income greater than \$7,500 and less than \$20,000.

The following illustration of the edited RPN program shows how program execution branches to the instructions added at the end of program memory, then branches back. While the actual program in ALG mode is different, the illustration does indicate the method used.

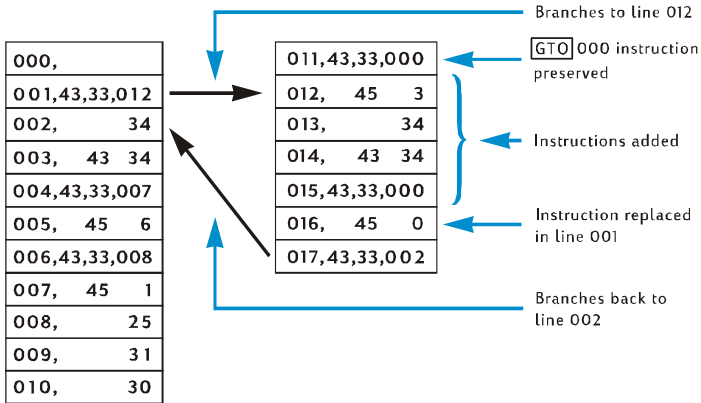

Multiple Programs

You can store multiple programs in program memory, provided that you separate them by instructions that will halt program execution after each program is run and return to the beginning of the program if it is run again. You can run programs after the first one stored in program memory by setting the calculator to the first line of the program using `GTO` before pressing `R/S`.

Storing Another Program

To store a program after another program is already stored in program memory:

1. Press `f` `P/R` to set the calculator to Program mode. Do *not* clear program memory.
2. Press `g` `GTO` `▢` followed by three digits that specify the number of the last line you keyed into program memory.

Note: If this is the second program to be stored in program memory, you will need to ensure that a `GTO`000 instruction separates it from the first program by doing step 3. If there are already two or more programs stored in program memory, skip step 3 and proceed with step 4.

3. Press `g` `GTO`000. This automatically converts a data storage register into seven additional lines of program memory (if there was not already a `GTO`000 instruction remaining at the end of program memory), and it ensures that program execution will branch to line 000 after the first program is run.
4. Key the program into program memory. If you are storing a program that you originally had written to be stored at the beginning of program memory and the program contains a `GTO` instruction, be sure to change the line number specified in the instruction so that the program will branch to the actual new line number.

Note: The next two steps are included so that program execution will halt after this program is run and will return to the beginning of the program if it is run again. If the program ends with a loop, you should skip steps 5 and 6 since the instructions in those steps would serve no purpose and never be executed.

5. Press `R/S`. This halts program execution at the end of the program.

152 Section 11: Multiple Programs

6. Press $\boxed{9} \boxed{GTO}$ followed by three digit keys that specify the first line number of your new program. This transfers program execution to the beginning of the new program when the program is run again.

Example 1: Assuming that program memory still contains the last program from the preceding section (which consisted of 17 program lines in RPN mode and 23 program lines in ALG mode), store after that program the office-supplies program from Section 8 (page 106). Since this is the second program to be stored in program memory, we'll ensure that a $\boxed{GTO}000$ instruction separates it from the first program by doing step 3 in the procedure above. Furthermore, since this program does not end with a loop, we'll do steps 5 and 6 too.

Keystrokes (RPN mode)

Display

| | | | |
|---|------------------|----|--|
| $\boxed{f} \boxed{P/R}$ | | | Sets calculator to Program mode. |
| $\boxed{9} \boxed{GTO} \boxed{\cdot} 017$ | 017, 43, 33, 002 | | Sets calculator to last line keyed into program memory. |
| $\boxed{9} \boxed{GTO} 000$ | 018, 43, 33, 000 | | Ensures that second program is separated from first by $\boxed{GTO}000$. |
| \boxed{ENTER} | 019, | 36 | } Keys in program. |
| 2 | 020, | 2 | |
| 5 | 021, | 5 | |
| $\boxed{\%}$ | 022, | 25 | |
| $\boxed{-}$ | 023, | 30 | |
| 5 | 024, | 5 | |
| $\boxed{+}$ | 025, | 40 | |
| $\boxed{R/S}$ | 026, | 31 | Halts program execution. |
| $\boxed{9} \boxed{GTO} 019$ | 027, 43, 33, 019 | | Branches to beginning of program. |
| $\boxed{f} \boxed{P/R}$ | 12, 000.00 | | Sets calculator back to Run mode. (Display shown assumes results remain from running program in previous example.) |

Keystrokes (ALG mode)

Display

| | | | |
|---|------------------|--|---|
| $\boxed{f} \boxed{P/R}$ | | | Sets calculator to Program mode. |
| $\boxed{9} \boxed{GTO} \boxed{\cdot} 023$ | 023, 43, 33, 002 | | Sets calculator to last line keyed into program memory. |

| Keystrokes (ALG mode) | Display | |
|---|------------------|---|
| g GTO 000 | 024, 43, 33, 000 | Ensures that second program is separated from first by GTO 000. |
| - | 025, 30 | } Keys in program. |
| 2 | 026, 2 | |
| 5 | 027, 5 | |
| % | 028, 25 | |
| + | 029, 40 | |
| 5 | 030, 5 | |
| = | 031, 36 | |
| R/S | 032, 31 | Halts program execution. |
| g GTO 025 | 033, 43, 33, 025 | Branches to beginning of program. |
| f P/R | 12, 000.00 | Sets calculator back to Run mode. (Display shown assumes results remain from running program in previous example.) |

Example 2: With the two programs now stored in program memory from the preceding examples (occupying 27 program lines in RPN mode and 33 lines in ALG mode), store the amortization program from Section 9 (page 127). Since there are already two programs stored in program memory, we'll skip step 3 in the procedure above. Furthermore, since the amortization program ends with a loop, we'll skip steps 5 and 6. When the amortization program was stored at the beginning of program memory, the GTO instruction at the end of the program branched to the RCL0 instruction in line 002. In the RPN program, since the RCL0 instruction is now in line 029, we'll specify that line number with the GTO instruction in line 034. In the ALG program, since the RCL0 instruction is now in line 035, we'll specify that line number with the GTO instruction in line 041.

| Keystrokes (RPN mode) | Display | |
|---|------------------|---|
| f P/R | | Sets calculator to Program mode. |
| g GTO . 027 | 027, 43, 33, 019 | Sets calculator to last line keyed into program memory. |

154 Section 11: Multiple Programs

Keystrokes (RPN mode)

STO 0
RCL 0
f AMORT
g PSE
X \bar{z} Y
g PSE
g GTO 029

Display

028, 44 0
029, 45 0
030, 42 11
031, 43 31
032, 34
033, 43 31
034, 43, 33, 029

} Keys in program

Keystrokes (ALG mode)

f P/R
g GTO \cdot 033
STO 0
RCL 0
f AMORT
g PSE
X \bar{z} Y
g PSE
g GTO 035

Display

033, 43, 33, 025
034, 44 0
035, 45 0
036, 42 11
037, 43 31
038, 34
039, 43 31
040, 43, 33, 035

Sets calculator to Program mode.

Sets calculator to last line keyed into program memory.

} Keys in program

Running Another Program

To run a program that does not begin with program line 001:

1. Press $\boxed{f} \boxed{P/R}$ to set the calculator to Run mode. If the calculator is already in Run mode, skip this step.
2. Press $\boxed{g} \boxed{GTO}$ followed by three digits that specify the first line of the program.
3. Press $\boxed{R/S}$.

Example: Run the office-supplies program, now stored in the calculator beginning at program line 019 in RPN mode and line 025 in ALG mode, for the typewriter listing for \$625.

Keystrokes (RPN mode)

| Keystrokes | Display | Description |
|-----------------------------|-----------|--|
| $\boxed{f} \boxed{P/R}$ | 12,000.00 | Sets calculator to Program mode. |
| $\boxed{g} \boxed{GTO} 019$ | 12,000.00 | Sets calculator to first line of program to be executed. |
| 625 $\boxed{R/S}$ | 473.75 | Net cost of typewriter. |

Keystrokes (ALG mode)

| Keystrokes | Display | Description |
|-----------------------------|-----------|--|
| $\boxed{f} \boxed{P/R}$ | 12,000.00 | Sets calculator to Program mode. |
| $\boxed{g} \boxed{GTO} 025$ | 12,000.00 | Sets calculator to first line of program to be executed. |
| 625 $\boxed{R/S}$ | 473.75 | Net cost of typewriter. |

Part III
Solutions

Section 12

Real Estate and Lending

Annual Percentage Rate Calculations With Fees

Borrowers are usually charged fees in connection with the issuance of a mortgage, which effectively raises the interest rate. The actual amount received by the borrower (PV) is reduced, while the periodic payments remain the same. Given the life or term of the mortgage, the interest rate, the mortgage amount, and the basis of the fee charge (how the fee is calculated), the true Annual Percentage Rate (APR) may be calculated. Information is entered as follows:

1. Press **9** **END** and **f** **CLEAR** **FIN**.
2. Calculate and enter the periodic payment amount of the loan.
 - a. Key in the total number of payment periods; press **n**.
 - b. Key in the periodic interest rate (as a percentage); press **i**.
 - c. Key in the mortgage amount; press **PV**.*
 - d. To obtain the periodic payment amount, press **PMT**.*
3. Calculate and key in the actual net amount disbursed.*

RPN Mode:

- If fees are stated as a percentage of the mortgage amount (points), recall the mortgage amount (**RCL** **PV**); key in the fee (percentage) rate; press **%** **-** **PV**.
- If fees are stated as a flat charge, recall the mortgage amount (**RCL** **PV**); key in the fee amount (flat charge); press **-** **PV**.
- If fees are stated as a percentage of the mortgage amount plus a flat charge, recall the mortgage amount (**RCL** **PV**); key in the fee (percentage) rate, press **%** **-**; key in the fee amount (flat charge); press **-** **PV**.

* Positive for cash received; negative for cash paid out.

ALG Mode:

- If fees are stated as a percentage of the mortgage amount (points), recall the mortgage amount ($\text{RCL} \text{ PV}$); press [-] ; key in the fee (percentage) rate; press [%] PV .
- If fees are stated as a flat charge, recall the mortgage amount ($\text{RCL} \text{ PV}$); press [-] ; key in the fee amount (flat charge); press PV .
- If fees are stated as a percentage of the mortgage amount plus a flat charge, recall the mortgage amount ($\text{RCL} \text{ PV}$); press [-] ; key in the fee (percentage) rate, press [%] [-] ; key in the fee amount (flat charge); press PV .

4. Press [i] to obtain the interest rate per compounding period.

5. **RPN:** To obtain the annual nominal percentage rate, key in the number of periods per year, then press [X] .

5. **ALG:** To obtain the annual nominal percentage rate, press [X] . Key in the number of periods per year, then press [=] .

Example 1: A borrower is charged 2 points for the issuance of his mortgage. If the mortgage amount is \$160,000 for 30 years and the interest rate is 5.5% per year, with monthly payments, what true annual percentage rate is the borrower paying? (One point is equal to 1% of the mortgage amount.)

| Keystrokes (RPN mode) | Keystrokes (ALG mode) | Display | |
|---|---|------------|---|
| [f] RPN | [f] ALG | | |
| [g] END | [g] END | | |
| [f] CLEAR [FIN] | [f] CLEAR [FIN] | | |
| $30 \text{ [g] } 12 \text{ [X]}$ | $30 \text{ [g] } 12 \text{ [X]}$ | 360.00 | Months (into n) |
| $5.5 \text{ [g] } 12 \text{ [÷]}$ | $5.5 \text{ [g] } 12 \text{ [÷]}$ | 0.46 | % monthly interest rate (into i). |
| 160000 [PV] | 160000 [PV] | 160,000.00 | Loan amount (into PV). |
| [PMT] | [PMT] | -908.46 | Monthly payment (calculated). |
| $\text{[RCL] [PV] } 2 \text{ [%] [-] [PV]}$ | $\text{[RCL] [PV] [-] } 2 \text{ [%] [PV]}$ | 156,800.00 | Actual amount received by borrower (into PV). |
| [i] | [i] | 0.47 | % monthly interest rate (calculated). |
| 12 [X] | $\text{[X] } 12 \text{ [=]}$ | 5.68 | Annual percentage rate. |

160 Section 12: Real Estate and Lending

Example 2: Using the same information as given in example 1, calculate the APR if the mortgage fee is \$750 instead of a percentage.

| Keystrokes (RPN mode) | Keystrokes (ALG mode) | Display | |
|-----------------------|-----------------------|------------|---|
| f RPN | f ALG | | |
| g END | g END | | |
| f CLEAR FIN | f CLEAR FIN | | |
| 30 g 12X | 30 g 12X | 360.00 | Months (into n) |
| 5.5 g 12÷ | 5.5 g 12÷ | 0.46 | Percent monthly interest rate (into i). |
| 160000 PV | 160000 PV | 160,000.00 | Loan amount (into PV). |
| PMT | PMT | -908.46 | Monthly payment (calculated). |
| RCL PV 750 - PV | RCL PV - 750 PV | 159,250.00 | Effective mortgage amount (into PV). |
| i | i | 0.46 | Monthly interest rate (calculated). |
| 12 X | X 12 = | 5.54 | Annual percentage rate. |

Example 3: Again using the information given in example 1, what is the APR if the mortgage fee is stated as 2 points plus \$750?

| Keystrokes (RPN mode) | Keystrokes (ALG mode) | Display | |
|-------------------------|-------------------------|------------|---|
| f RPN | f ALG | | |
| g END | g END | | |
| f CLEAR FIN | f CLEAR FIN | | |
| 30 g 12X | 30 g 12X | 360.00 | Months (into n) |
| 5.5 g 12÷ | 5.5 g 12÷ | 0.46 | Percent monthly interest rate (into i). |
| 160000 PV | 160000 PV | 160,000.00 | Loan amount (into PV). |
| PMT | PMT | -908.46 | Monthly payment (calculated). |
| RCL PV 2% - 750 - PV | RCL PV - 2% - 750 PV | 156,050.00 | Effective mortgage amount (into PV). |

| Keystrokes (RPN mode) | Keystrokes (ALG mode) | Display | |
|-----------------------|---------------------------------|---------|-------------------------------------|
| \boxed{i} | \boxed{i} | 0 . 48 | Monthly interest rate (calculated). |
| 12 $\boxed{\times}$ | $\boxed{\times}$ 12 $\boxed{=}$ | 5 . 73 | Annual percentage rate. |

Price of a Mortgage Traded at a Discount or Premium

Mortgages may be bought and/or sold at prices lower (discounted) or higher (at a premium) than the remaining balance of the loan at the time of purchase. Given the amount of the mortgage, the periodic payment, the timing and amount of the balloon or prepayment, and the *desired* yield rate, the price of the mortgage may be found. It should be noted that the balloon payment amount (if it exists) occurs coincident with, and does not include, the last periodic payment amount.

Information is entered as follows:

1. Press \boxed{g} \boxed{END} and \boxed{f} \boxed{CLEAR} \boxed{FIN} .
2. Key in the total number of periods until the balloon payment or prepayment occurs; press \boxed{n} . (If there is no balloon payment, key in total number of payments and press \boxed{n} .)
3. Key in the desired periodic interest rate (yield) and press \boxed{i} .
4. Key in the periodic payment amount; press \boxed{PMT} .*
5. Key in the balloon payment amount and press \boxed{FV} .* (If there is no balloon payment, go to step 6.)
6. Press \boxed{PV} to obtain the purchase price of the mortgage.

Example 1: A lender wishes to induce the borrower to prepay a low interest rate loan. The interest rate is 5% with 72 payments remaining of \$137.17 and a balloon payment at the end of the sixth year of \$2,000. If the lender is willing to discount the future payments at 9%, how much would the borrower need to prepay the note?

| Keystrokes (RPN mode) | Keystrokes (ALG mode) | Display | |
|--|--|---------|------------------|
| \boxed{f} \boxed{RPN} | \boxed{f} \boxed{ALG} | | |
| \boxed{g} \boxed{END} \boxed{f} \boxed{CLEAR} \boxed{FIN} 72 \boxed{n} | \boxed{g} \boxed{END} \boxed{f} \boxed{CLEAR} \boxed{FIN} 72 \boxed{n} | 72 . 00 | Months (into n). |

* Positive for cash received; negative for cash paid out.

162 Section 12: Real Estate and Lending

| Keystrokes (RPN mode) | Keystrokes (ALG mode) | Display | |
|--------------------------|--------------------------|-----------|--------------------------------------|
| 9 [g] [12÷] | 9 [g] [12÷] | 0.75 | Discount rate (into i). |
| 137.17 [PMT] * | 137.17 [PMT] * | 137.17 | Monthly payments (into PMT). |
| 2000 [FV] [PV] | 2000 [FV] [PV] | -8,777.61 | Amount necessary to prepay the note. |

Example 2: A 6.5% mortgage with 26 years remaining and a remaining balance of \$249,350 is available for purchase. Determine the price to pay for this mortgage if the desired yield is 12%. (Since the payment amount is not given, it must be calculated.)

| Keystrokes (RPN mode) | Keystrokes (ALG mode) | Display | |
|--|--|-------------|---|
| [f] [RPN] | [f] [ALG] | | |
| [g] [END] [f] [CLEAR] [FIN] 26 [g] [12x] | [g] [END] [f] [CLEAR] [FIN] 26 [g] [12x] | 312.00 | Months (into n). |
| 6.5 [g] [12÷] | 6.5 [g] [12÷] | 0.54 | Percent monthly interest rate (into i). |
| 249350 [CHS] [PV] [PMT] | 249350 [CHS] [PV] [PMT] | 1,657.97 | Monthly payment to be received (calculated). |
| 12 [g] [12÷] | 12 [g] [12÷] | 1.00 | Desired monthly interest rate (into i). |
| [PV] | [PV] | -158,361.78 | Purchase price to achieve the desired yield (calculated). |

* Note that the payments are positive because this problem is in seen from the viewpoint of the lender who will be receiving payments. The negative PV indicates money that was lent out.

Yield of a Mortgage Traded at a Discount or Premium

The annual yield of a mortgage bought at a discount or premium can be calculated given the original mortgage amount, interest rate, and periodic payment, as well as the number of payment periods per year, the price paid for the mortgage, and the balloon payment amount (if it exists).

Information is entered as follows:

1. Press **g** **END** and **f** **CLEAR** **FIN**.
 2. Key in the total number of periods until the balloon payment occurs and press **n**. (If there is no balloon payment, key in the total number of periods and press **n**.)
 3. Key in the periodic payment amount then press **PMT**.*
 4. Key in the purchase price of the mortgage then press **PV**.*
 5. Key in the balloon payment amount then press **FV**.* (If there is no balloon payment, go to step 6.)
 6. Press **i** to obtain the yield per period.
7. **RPN:** Key in the number of periods per year and press **X** to obtain the nominal annual yield.
 7. **ALG:** Press **X**. Key in the number of periods per year and press **=** to obtain the nominal annual yield.

Example 1: An investor wishes to purchase a \$300,000 mortgage taken out at 6% for 21 years. Since the mortgage was issued, 42 monthly payments have been made. What would be the annual yield if the purchase price of the mortgage is \$250,000? (Since PMT was not given, it must be calculated).

| Keystrokes (RPN mode) | Keystrokes (ALG mode) | Display | |
|---|---|-------------|--|
| f RPN | f ALG | | |
| g END f CLEAR FIN 21 g 12X | g END f CLEAR FIN 21 g 12X | 252.00 | Enter the number of periods (into n). |
| 6 g 12÷ | 6 g 12÷ | 0.50 | Monthly interest rate (into i). |
| 300000 CHS PV | 300000 CHS PV | -300,000.00 | Mortgage amount (into PV; negative to indicate |

* Positive for cash received; negative for cash paid out.

164 Section 12: Real Estate and Lending

| Keystrokes (RPN mode) | Keystrokes (ALG mode) | Display | |
|--|--|-------------|---|
| | | | money paid out). |
| <code>PMT</code> | <code>PMT</code> | 2,096.57 | Payment received (calculated). |
| <code>RCL</code> <code>n</code> | <code>RCL</code> <code>n</code> | 252.00 | Recall number of periods. |
| <code>42</code> <code>-</code> <code>n</code> | <code>-</code> <code>42</code> <code>n</code> | 210.00 | Number of periods left after mortgage is bought (into n). |
| <code>250000</code> <code>CHS</code> <code>PV</code> | <code>250000</code> <code>CHS</code> <code>PV</code> | -250,000.00 | Input price of mortgage (into PV; negative to indicate money paid out). |
| <code>i</code> | <code>i</code> | 0.60 | Yield per month (calculated). |
| <code>12</code> <code>X</code> | <code>X</code> <code>12</code> <code>=</code> | 7.20 | Percent annual yield. |

Example 2: Using the same information given in example 1, calculate the annual yield if the loan is to be paid in full at the end of the fifth year (from original issuance). (In this case both the payment amount and the balloon must be calculated since they are not given.)

| Keystrokes (RPN mode) | Keystrokes (ALG mode) | Display | |
|--|--|-------------|---------------------------------------|
| <code>f</code> <code>RPN</code> | <code>f</code> <code>ALG</code> | | |
| <code>g</code> <code>END</code> <code>f</code> <code>CLEAR</code> <code>FIN</code> <code>21</code> <code>g</code> <code>12X</code> | <code>g</code> <code>END</code> <code>f</code> <code>CLEAR</code> <code>FIN</code> <code>21</code> <code>g</code> <code>12X</code> | 252.00 | Input the number of periods (into n). |
| <code>6</code> <code>g</code> <code>12</code> <code>÷</code> | <code>6</code> <code>g</code> <code>12</code> <code>÷</code> | 0.50 | Monthly interest rate (into PV). |
| <code>300000</code> <code>CHS</code> <code>PV</code> | <code>300000</code> <code>CHS</code> <code>PV</code> | -300,000.00 | Mortgage amount (into PV). |
| <code>PMT</code> | <code>PMT</code> | 2,096.57 | Payment (calculated). |

Calculate the remaining balance of the loan after five years.

| Keystrokes (RPN mode) | Keystrokes (ALG mode) | Display | |
|---|---|------------|---|
| 5 g 12x | 5 g 12x | 60.00 | Number of periods to be amortized. |
| FV | FV | 258,377.24 | Remaining balance of the loan after five years. |
| RCL n | RCL n | 60.00 | |
| 42 - n | - 42 n | 18.00 | New life of loan. |
| 250000 CHS PV i | 250000 CHS PV i | 1.01 | Percent monthly yield. (calculated). |
| 12 X | X 12 = | 12.11 | Percent annual yield. |

The Rent or Buy Decision

The question of whether to rent or purchase a residence is not always easy to answer, especially when the time period over which you would own or rent a house is short. This program performs an analysis which could be helpful in reaching a decision. Essentially, it calculates a yield or rate of return on the proposed investment. This yield may be compared with the yield obtained by renting a residence and investing the down payment and monthly payment differences in a savings account or other investment opportunity. This program takes into account the tax advantages obtained by a home owner on property taxes and mortgage interest.

First the program computes the Net Cash Proceeds upon Resale (NCPR),* next the yield on the investment in the house and then the value of the hypothetical savings account at the end of the investment period. A comparison of the NCPR and the final balance of the savings account and a comparison of the yields should aid in determining whether to rent or buy.

* The Net Cash Proceeds upon Resale (NCPR = sales price – commission – mortgage balance), is the pre-tax proceeds. The program assumes that the buyer reinvests in like property and is not subject to capital gains tax.

| KEYSTROKES (RPN mode) | DISPLAY | KEYSTROKES (ALG mode) | DISPLAY |
|----------------------------------|----------------|----------------------------------|----------------|
| \boxed{f} CLEAR \boxed{PRGM} | 000 , | \boxed{f} CLEAR \boxed{PRGM} | 000 , |
| \boxed{FV} | 001 , 15 | \boxed{FV} | 001 , 15 |
| $\boxed{FV} *$ | 002 , 15 | $\boxed{FV} *$ | 002 , 15 |
| \boxed{CHS} | 003 , 16 | \boxed{CHS} | 003 , 16 |
| \boxed{STO} $\boxed{\cdot}$ 1 | 004 , 44 48 1 | \boxed{STO} $\boxed{\cdot}$ 1 | 004 , 44 48 1 |
| \boxed{RCL} \boxed{n} | 005 , 45 11 | \boxed{RCL} \boxed{n} | 005 , 45 11 |
| \boxed{STO} 0 | 006 , 44 0 | \boxed{STO} 0 | 006 , 44 0 |
| \boxed{RCL} \boxed{PV} | 007 , 45 13 | \boxed{RCL} \boxed{PV} | 007 , 45 13 |
| \boxed{f} CLEAR \boxed{FIN} | 008 , 42 34 | \boxed{f} CLEAR \boxed{FIN} | 008 , 42 34 |
| \boxed{RCL} 1 | 009 , 45 1 | $\boxed{-}$ | 009 , 30 |
| $\boxed{-}$ | 010 , 30 | \boxed{RCL} 1 | 010 , 45 1 |
| \boxed{PV} | 011 , 13 | \boxed{PV} | 011 , 13 |
| \boxed{RCL} 2 | 012 , 45 2 | \boxed{RCL} 2 | 012 , 45 2 |
| \boxed{g} $\boxed{12X}$ | 013 , 43 11 | \boxed{g} $\boxed{12X}$ | 013 , 43 11 |
| \boxed{RCL} 3 | 014 , 45 3 | \boxed{RCL} 3 | 014 , 45 3 |
| \boxed{g} $\boxed{12\div}$ | 015 , 43 12 | \boxed{g} $\boxed{12\div}$ | 015 , 43 12 |
| \boxed{PMT} | 016 , 14 | \boxed{PMT} | 016 , 14 |
| 0 | 017 , 0 | 0 | 017 , 0 |
| \boxed{n} | 018 , 11 | \boxed{n} | 018 , 11 |
| \boxed{RCL} 0 | 019 , 45 0 | \boxed{RCL} 0 | 019 , 45 0 |
| 1 | 020 , 1 | \boxed{X} | 020 , 20 |
| 2 | 021 , 2 | 1 | 021 , 1 |

* FV is repeated in the program twice to ensure that it is computed and not stored.

| KEYSTROKES (RPN mode) | DISPLAY | KEYSTROKES (ALG mode) | DISPLAY |
|-------------------------------|--------------|-------------------------------|--------------|
| $\boxed{\times}$ | 022, 20 | 2 | 022, 2 |
| $\boxed{f} \boxed{AMORT}$ | 023, 42 11 | $\boxed{f} \boxed{AMORT}$ | 023, 42 11 |
| \boxed{CHS} | 024, 16 | \boxed{CHS} | 024, 16 |
| $\boxed{RCL} \boxed{n}$ | 025, 45 11 | $\boxed{\div}$ | 025, 10 |
| $\boxed{\div}$ | 026, 10 | $\boxed{RCL} \boxed{n}$ | 026, 45 11 |
| $\boxed{RCL} 4$ | 027, 45 4 | $\boxed{+}$ | 027, 40 |
| $\boxed{+}$ | 028, 40 | $\boxed{RCL} 4$ | 028, 45 4 |
| $\boxed{RCL} \boxed{\cdot} 0$ | 029, 45 48 0 | $\boxed{\times}$ | 029, 20 |
| $\boxed{\%}$ | 030, 25 | $\boxed{RCL} \boxed{\cdot} 0$ | 030, 45 48 0 |
| $\boxed{RCL} 4$ | 031, 45 4 | $\boxed{\%}$ | 031, 25 |
| $\boxed{-}$ | 032, 30 | $\boxed{-}$ | 032, 30 |
| $\boxed{RCL} 5$ | 033, 45 5 | $\boxed{RCL} 4$ | 033, 45 4 |
| $\boxed{-}$ | 034, 30 | $\boxed{-}$ | 034, 30 |
| $\boxed{RCL} 8$ | 035, 45 8 | $\boxed{RCL} 5$ | 035, 45 5 |
| $\boxed{+}$ | 036, 40 | $\boxed{+}$ | 036, 40 |
| $\boxed{RCL} \boxed{PMT}$ | 037, 45 14 | $\boxed{RCL} 8$ | 037, 45 8 |
| $\boxed{+}$ | 038, 40 | $\boxed{+}$ | 038, 40 |
| \boxed{PMT} | 039, 14 | $\boxed{RCL} \boxed{PMT}$ | 039, 45 14 |
| $\boxed{RCL} \boxed{\cdot} 1$ | 040, 45 48 1 | \boxed{PMT} | 040, 14 |
| $\boxed{RCL} 7$ | 041, 45 7 | $\boxed{RCL} \boxed{\cdot} 1$ | 041, 45 48 1 |
| $\boxed{\%}$ | 042, 25 | $\boxed{-}$ | 042, 30 |
| $\boxed{-}$ | 043, 30 | $\boxed{RCL} 7$ | 043, 45 7 |
| $\boxed{RCL} \boxed{PV}$ | 044, 45 13 | $\boxed{\%}$ | 044, 25 |

168 Section 12: Real Estate and Lending

| KEYSTROKES (RPN mode) | DISPLAY | KEYSTROKES (ALG mode) | DISPLAY |
|--------------------------|----------------|--------------------------|----------------|
| \square | 045, 30 | \square | 045, 30 |
| FV | 046, 15 | RCL PV | 046, 45 13 |
| R/S | 047, 31 | FV | 047, 15 |
| RCL 1 | 048, 45 1 | R/S | 048, 31 |
| RCL 6 | 049, 45 6 | RCL 1 | 049, 45 1 |
| + | 050, 40 | CHS | 050, 16 |
| CHS | 051, 16 | \square | 051, 30 |
| PV | 052, 13 | RCL 6 | 052, 45 6 |
| i | 053, 12 | PV | 053, 13 |
| RCL 9 12÷ | 054, 45, 43 12 | i | 054, 12 |
| R/S | 055, 31 | RCL 9 12÷ | 055, 45, 43 12 |
| RCL 9 | 056, 45 9 | R/S | 056, 31 |
| 9 12÷ | 057, 43 12 | RCL 9 | 057, 45 9 |
| FV | 058, 15 | 9 12÷ | 058, 43 12 |
| f P/R | | FV | 059, 15 |
| | | f P/R | |

| REGISTERS | | | |
|----------------------------|---------------------------|------------------------------|------------------------------|
| n: Period | i: Apprec. | PV: Price | PMT: Used |
| FV: Used | R ₀ : Period | R ₁ : Dwn Pmt | R ₂ : Life |
| R ₃ : i(Mtg) | R ₄ : Taxes/Mo | R ₅ : Improve./mo | R ₆ : Closing C. |
| R ₇ : % Comm. | R ₈ : Rent | R ₉ : Savings i | R ₀ : Tax Bracket |
| R ₁ : Market V. | | | |

1. Key in the program.
2. Key in the estimated down payment then press **[STO]**1.
3. Key in the life of the mortgage then press **[STO]**2.
4. Key in the annual mortgage interest rate then press **[STO]**3.
5. Key in the estimated monthly taxes then press **[STO]**4.
6. Key in the total amount estimated for monthly repairs, improvements, incremental insurance, utility costs, and other expenses, then press **[STO]**5.
7. Key in the closing costs then press **[STO]**6.
8. Key in the selling cost as a percentage of the selling price. This should include sales commission, escrow fees, etc. then press **[STO]**7.
9. Key in the monthly rent for the alternative housing then press **[STO]**8.
10. Key in the savings or alternative investment annual interest rate as a percentage then press **[STO]**9.
11. Key in the combined State and Federal marginal tax rate* as a percentage then press **[STO]**•0.
12. Press **[g]****[END]** and **[f]****[CLEAR]****[FIN]** then key in the number of years involved in the investment; press **[n]**.
13. Key in the estimated rate of yearly appreciation as a percentage then press **[i]**.
14. Key in the price of the house under consideration then press **[PV]**.
15. Press **[R/S]** to compute the net proceeds from the sale of the house. (A negative value indicates money lost.)
16. Press **[R/S]** to compute the yield on your investment in the house.†
17. Press **[R/S]** to compute the value of a savings account or other investment.
18. Compare the value of the hypothetical savings account to the net proceeds of the sale of the house. Examine the sign and magnitude of the yield to arrive at your decision.
19. To change data and repeat the calculations, store the changed values in the appropriate registers and go to step 12.

* The user should key in the total marginal income tax — Federal plus State — to obtain calculations which reflect the tax advantages of home ownership. Because of the complexities of tax laws and different financial and tax considerations for each individual, this program should only serve as a guide in considering an investment of this type. For more specific, detailed information, consult a tax accountant or qualified tax advisor.

† If the calculator displays a negative result or **Error 5** when solving for yield then your investment has resulted in a loss. The amount of interest earned on the alternative investment is not taken into account in this calculation.

170 Section 12: Real Estate and Lending

Example: You are being transferred for 4 years to a distant city and are faced with the decision of whether to rent or to buy a house. A quick survey of the housing market indicates that you can purchase an acceptable house for \$270,000 with a \$7,000 down payment on a 30-year mortgage at 6% interest. The closing costs would be about \$3,700. Selling costs include a 6% commission for resale and miscellaneous other fees that amount to another 2% of the sale price. Housing in the area is appreciating 5% per year. Property taxes would be about \$300 per month, and you estimate that maintenance would cost an additional \$165 per month.

An alternative would be to rent a similar dwelling at \$900 per month and to invest the difference between the purchase cost and rent at 3% interest. Your personal income tax rate (marginal) is 25% Federal and 5% State. Which alternative is more financially attractive?

| Keystrokes (RPN mode) | Keystrokes (ALG mode) | Display | |
|-----------------------|-----------------------|----------------|---------------------------------|
| f RPN | f ALG | | |
| g END | g END | | |
| f CLEAR REG | f CLEAR REG | 0 . 00 | |
| 7000 STO 1 | 7000 STO 1 | 7 , 000 . 00 | Down payment. |
| 30 STO 2 | 30 STO 2 | 30 . 00 | Life of mortgage. |
| 6 STO 3 | 6 STO 3 | 6 . 00 | Interest rate. |
| 300 STO 4 | 300 STO 4 | 300 . 00 | Property taxes. |
| 165 STO 5 | 165 STO 5 | 165 . 00 | Monthly expenses. |
| 3700 STO 6 | 3700 STO 6 | 3 , 700 . 00 | Closing costs. |
| 8 STO 7 | 8 STO 7 | 8 . 00 | Resale costs (as a percentage). |
| 900 STO 8 | 900 STO 8 | 900 . 00 | Rent. |
| 3 STO 9 | 3 STO 9 | 3 . 00 | Savings interest rate. |
| 30 STO . 0 | 30 STO . 0 | 30 . 00 | Tax bracket. |
| f CLEAR FIN | f CLEAR FIN | 30 . 00 | Clear financial registers. |
| 4 n | 4 n | 4 . 00 | Years in investment. |
| 5 i | 5 i | 5 . 00 | Yearly appreciation rate. |
| 270000 PV | 270000 PV | 270 , 000 . 00 | House price. |
| R/S | R/S | 53 , 095 . 65 | NCPR (calculated). |

| Keystrokes (RPN mode) | Keystrokes (ALG mode) | Display | |
|--------------------------|--------------------------|-----------|---------------------|
| <code>R/S</code> | <code>R/S</code> | 8.57 | Yield. |
| <code>R/S</code> | <code>R/S</code> | 46,048.61 | Balance in savings. |

By purchasing a house, you would gain \$7,047.04 ($53,095.65 - 46,048.61$) over an alternate investment at 3% interest.

Deferred Annuities

Sometimes transactions are established where payments do not begin for a specified number of periods; the payments are deferred. The technique for calculating *NPV* may be applied assuming zero for the first cash flow. Refer to pages 73 through 77.

Example 1: You have just inherited \$20,000 and wish to put some of it aside for your daughter's college education. You estimate that when she is of college age, 9 years from now, she will need \$7,000 at the beginning of each year for 4 years for college tuition and expenses. You wish to establish a fund which earns 6% annually. How much do you need to deposit in the fund today to meet your daughter's educational expenses?

| Keystrokes (RPN mode) | Keystrokes (ALG mode) | Display | |
|--|--|------------------|---|
| <code>f RPN</code> | <code>f ALG</code> | | |
| <code>f CLEAR REG</code> | <code>f CLEAR REG</code> | 0.00 | Initialize. |
| <code>0 g CFo</code> | <code>0 g CFo</code> | 0.00 | First cash flow. |
| <code>0 g CFj</code> <code>8 g Nj</code> | <code>0 g CFj</code> <code>8 g Nj</code> | 0.00 8.00 | Second through ninth cash flows. |
| <code>7000 g CFj</code> <code>4 g Nj</code> | <code>7000 g CFj</code> <code>4 g Nj</code> | 7,000.00 4.00 | Tenth through thirteenth cash flows. |
| <code>6 i</code> | <code>6 i</code> | 6.00 | Interest. |
| <code>f NPV</code> | <code>f NPV</code> | 15,218.35 | NPV. |

172 Section 12: Real Estate and Lending

Leases often call for periodic contractual adjustments of rental payments. For example, a 2-year lease calls for monthly payments (at the beginning of the month) of \$500 per month for the first 6 months, \$600 per month for the next 12 months, and \$750 per month for the last 6 months. This situation illustrates what is called a “step-up” lease. A “step-down” lease is similar, except that rental payments are decreased periodically according to the lease contract. Lease payments are made at the beginning of the period.

In the example cited, the rental payment stream for months 7 through 24 are “deferred annuities,” as they start at some time in the future. The cash flow diagram from the investor’s viewpoint looks like this:

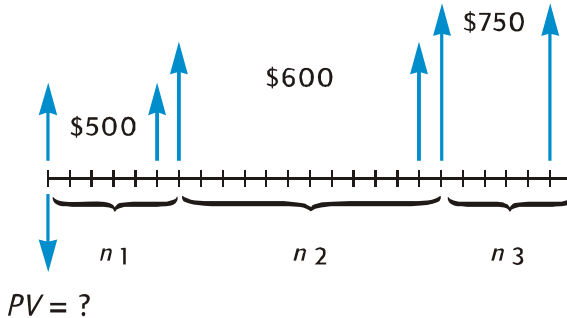

To find today’s present value of the cash flows assuming a desired yield, the *NPV* technique may be used. (Refer to pages 73 through 77.)

Example 2: A 2-year lease calls for monthly payments (at the beginning of the month) of \$500 per month for the first 6 months, \$600 per month for the next 12 months, and \$750 per month for the last 6 months. If you wish to earn 13.5% annually on these cash flows, how much should you invest (what is the present value of the lease)?

| Keystrokes (RPN mode) | Keystrokes (ALG mode) | Display | |
|--|--|---------------------|----------------------------------|
| f RPN | f ALG | | |
| f CLEAR REG | f CLEAR REG | 0 . 00 | Initialize. |
| 500 g CF ₀ | 500 g CF ₀ | 500 . 00 | First cash flow. |
| g CF ₁ 5 g N ₁ | g CF ₁ 5 g N ₁ | 500 . 00 5 . 00 | Second through sixth cash flows. |
| 600 g CF ₁ 12 g N ₁ | 600 g CF ₁ 12 g N ₁ | 600 . 00 12 . 00 | Next twelve cash flows. |
| 750 g CF ₁ 6 g N ₁ | 750 g CF ₁ 6 g N ₁ | 750 . 00 6 . 00 | Last six cash flows. |

| Keystrokes (RPN mode) | Keystrokes (ALG mode) | Display | |
|--|--|----------------|--|
| 13.5 <input type="text" value="g"/> <input type="text" value="12÷"/> | 13.5 <input type="text" value="g"/> <input type="text" value="12÷"/> | 1 . 13 | Monthly interest rate. |
| <input type="text" value="f"/> <input type="text" value="NPV"/> | <input type="text" value="f"/> <input type="text" value="NPV"/> | 12 , 831 . 75 | Amount to invest to achieve a 13.5% yield. |

Section 13

Investment Analysis

Partial-Year Depreciation

For both income tax purposes and financial analyses, it is valuable to calculate depreciation based on a calendar or fiscal accounting year. When the acquisition date of an asset does not coincide with the start of the year — which is the rule rather than the exception — the amounts of depreciation in the first and last years are computed as fractions of a full year's depreciation.

Straight-Line Depreciation

The following hp 12c platinum program calculates the straight-line depreciation for the year desired with the acquisition date occurring at any time during the year.

| KEYSTROKES (RPN mode) | DISPLAY | KEYSTROKES (ALG mode) | DISPLAY |
|---------------------------|---------------------|---------------------------|--------------------|
| <code>f P/R</code> | | <code>f P/R</code> | |
| <code>f CLEAR PRGM</code> | 000 , | <code>f CLEAR PRGM</code> | 000 , |
| 1 | 001 , 1 | <code>÷</code> | 001 , 10 |
| 2 | 002 , 2 | 1 | 002 , 1 |
| <code>÷</code> | 003 , 10 | 2 | 003 , 2 |
| <code>STO 1</code> | 004 , 44 1 | <code>=</code> | 004 , 36 |
| <code>x↔y</code> | 005 , 34 | <code>STO 1</code> | 005 , 44 1 |
| <code>STO 2</code> | 006 , 44 2 | <code>x↔y</code> | 006 , 34 |
| 1 | 007 , 1 | <code>STO 2</code> | 007 , 44 2 |
| <code>-</code> | 008 , 30 | <code>-</code> | 008 , 30 |
| <code>STO 0</code> | 009 , 44 0 | 1 | 009 , 1 |
| 1 | 010 , 1 | <code>=</code> | 010 , 36 |
| <code>f SL</code> | 011 , 42 23 | <code>STO 0</code> | 011 , 44 0 |

| KEYSTROKES (RPN mode) | DISPLAY |
|--|------------------|
| $\boxed{\text{RCL}} \boxed{1}$ | 012, 45 1 |
| $\boxed{\times}$ | 013, 20 |
| $\boxed{\text{STO}} \boxed{3}$ | 014, 44 3 |
| $\boxed{\text{RCL}} \boxed{\text{PV}}$ | 015, 45 13 |
| $\boxed{\times \div y}$ | 016, 34 |
| $\boxed{-}$ | 017, 30 |
| $\boxed{\text{PV}}$ | 018, 13 |
| $\boxed{\text{RCL}} \boxed{n}$ | 019, 45 11 |
| $\boxed{\text{RCL}} \boxed{1}$ | 020, 45 1 |
| $\boxed{-}$ | 021, 30 |
| \boxed{n} | 022, 11 |
| $\boxed{\text{RCL}} \boxed{0}$ | 023, 45 0 |
| $\boxed{g} \boxed{\times=0}$ | 024, 43 35 |
| $\boxed{g} \boxed{\text{GTO}} \boxed{035}$ | 025, 43, 33, 035 |
| $\boxed{\text{RCL}} \boxed{2}$ | 026, 45 2 |
| $\boxed{g} \boxed{\text{PSE}}$ | 027, 43 31 |
| $\boxed{\text{RCL}} \boxed{0}$ | 028, 45 0 |
| $\boxed{f} \boxed{\text{SL}}$ | 029, 42 23 |
| $\boxed{\text{R/S}}$ | 030, 31 |
| 1 | 031, 1 |
| $\boxed{\text{STO}} \boxed{+} \boxed{0}$ | 032, 44 40 0 |
| $\boxed{\text{STO}} \boxed{+} \boxed{2}$ | 033, 44 40 2 |
| $\boxed{g} \boxed{\text{GTO}} \boxed{026}$ | 034, 43, 33, 026 |
| $\boxed{\text{RCL}} \boxed{2}$ | 035, 45 2 |

| KEYSTROKES (ALG mode) | DISPLAY |
|--|------------------|
| 1 | 012, 1 |
| $\boxed{f} \boxed{\text{SL}}$ | 013, 42 23 |
| $\boxed{\times}$ | 014, 20 |
| $\boxed{\text{RCL}} \boxed{1}$ | 015, 45 1 |
| $\boxed{=}$ | 016, 36 |
| $\boxed{\text{STO}} \boxed{3}$ | 017, 44 3 |
| $\boxed{\text{RCL}} \boxed{\text{PV}}$ | 018, 45 13 |
| $\boxed{-}$ | 019, 30 |
| $\boxed{\times \div y}$ | 020, 34 |
| $\boxed{\text{PV}}$ | 021, 13 |
| $\boxed{\text{RCL}} \boxed{n}$ | 022, 45 11 |
| $\boxed{-}$ | 023, 30 |
| $\boxed{\text{RCL}} \boxed{1}$ | 024, 45 1 |
| \boxed{n} | 025, 11 |
| $\boxed{\text{RCL}} \boxed{0}$ | 026, 45 0 |
| $\boxed{g} \boxed{\times=0}$ | 027, 43 35 |
| $\boxed{g} \boxed{\text{GTO}} \boxed{038}$ | 028, 43, 33, 038 |
| $\boxed{\text{RCL}} \boxed{2}$ | 029, 45 2 |
| $\boxed{g} \boxed{\text{PSE}}$ | 030, 43 31 |
| $\boxed{\text{RCL}} \boxed{0}$ | 031, 45 0 |
| $\boxed{f} \boxed{\text{SL}}$ | 032, 42 23 |
| $\boxed{\text{R/S}}$ | 033, 31 |
| 1 | 034, 1 |
| $\boxed{\text{STO}} \boxed{+} \boxed{0}$ | 035, 44 40 0 |

176 Section 13: Investment Analysis

| KEYSTROKES (RPN mode) | DISPLAY | KEYSTROKES (ALG mode) | DISPLAY |
|-------------------------------|----------------|-------------------------------|----------------|
| \boxed{g} \boxed{PSE} | 036, 43 31 | \boxed{STO} $\boxed{+}$ 2 | 036,44 40 2 |
| \boxed{RCL} \boxed{PV} | 037, 45 13 | \boxed{g} \boxed{GTO} 029 | 037,43,33, 029 |
| \boxed{RCL} \boxed{FV} | 038, 45 15 | \boxed{RCL} 2 | 038, 45 2 |
| $\boxed{-}$ | 039, 30 | \boxed{g} \boxed{PSE} | 039, 43 31 |
| \boxed{RCL} 3 | 040, 45 3 | \boxed{RCL} \boxed{PV} | 040, 45 13 |
| \boxed{g} \boxed{GTO} 030 | 041,43,33, 030 | $\boxed{-}$ | 041, 30 |
| \boxed{f} $\boxed{P/R}$ | | \boxed{RCL} \boxed{FV} | 042, 45 15 |
| | | $\boxed{=}$ | 043, 36 |
| | | \boxed{RCL} 3 | 044, 45 3 |
| | | \boxed{g} \boxed{GTO} 033 | 045,43,33, 033 |
| | | \boxed{f} $\boxed{P/R}$ | |

| REGISTERS | | | |
|---|---|---------------------------|--------------------------|
| n: Life | i: Unused | PV: Dep. Value | PMT: Unused |
| FV: Salvage | R ₀ : Used | R ₁ : #Mos./12 | R ₂ : Counter |
| R ₃ : 1 st Yr. Dep. | R ₄ -R ₄ : Unused | | |

1. Key in the program.
2. Press \boxed{f} \boxed{CLEAR} \boxed{FIN} .
3. Key in the book value then press \boxed{PV} .
4. Key in the salvage value then press \boxed{FV} .
5. Key in the life in years (an integer) then press \boxed{n} .

178 Section 13: Investment Analysis

| Keystrokes (RPN mode) | Keystrokes (ALG mode) | Display | |
|--|--|--------------------------------|---|
| f RPN | f ALG | | |
| f CLEAR FIN | f CLEAR FIN | | Salvage value = 0 so $FV = 0$; set to 0 by CLEAR FIN. |
| 125000 PV | 125000 PV | 125,000.00 | Book value. |
| 25 n | 25 n | 25.00 | Life. |
| 1 ENTER | 1 = | 1.00 | Year desired. |
| 4 R/S X↔Y | 4 R/S X↔Y | 1.00 1,666.67 123,333.33 | First year: depreciation, remaining depreciable value. |
| R/S X↔Y | R/S X↔Y | 2.00 5,000.00 118,333.33 | Second year: depreciation, remaining depreciable value. |
| R/S | R/S | 3.00 5,000.00 | Third year: depreciation. |
| X↔Y RCL PV RCL 3 + X↔Y - g GTO 000 | X↔Y RCL PV + RCL 3 - X↔Y = g GTO 000 | 11,666.67 | Total depreciation through third year. |
| f CLEAR FIN | f CLEAR FIN | 11,666.67 | |
| 125000 PV | 125000 PV | 125,000.00 | Book value. |
| 25 n | 25 n | 25.00 | Life. |
| 25 ENTER | 25 = | 25.00 | Year desired. |
| 4 R/S X↔Y | 4 R/S X↔Y | 25.00 5,000.00 3,333.33 | Twenty-fifth year: depreciation, remaining depreciable value. |
| R/S X↔Y | R/S X↔Y | 26.00 3,333.33 0.00 | Twenty-sixth year: depreciation, remaining depreciable value. |

Example 2: A used car was purchased for \$6,730 with 4.5 months remaining in the year. If the expected life of the car is 5 years, what is the amount of depreciation in the first year?

| Keystrokes (RPN mode) | Keystrokes (ALG mode) | Display | |
|----------------------------|----------------------------|----------------|------------------------------|
| f RPN | f ALG | | |
| g GTO 000 f CLEAR FIN | g GTO 000 f CLEAR FIN | | |
| 6730 PV | 6730 PV | 6,730.00 | Book value. |
| 5 n | 5 n | 5.00 | Life. |
| 1 ENTER | 1 = | 1.00 | |
| 4.5 R/S | 4.5 R/S | 1.00 504.75 | First year: depreciation. |

Declining-Balance Depreciation

The following hp 12c platinum program calculates the declining-balance depreciation for the year desired with the acquisition date occurring at any time during the year.

| KEYSTROKES (RPN mode) | DISPLAY | KEYSTROKES (ALG mode) | DISPLAY |
|-----------------------|-----------|-----------------------|-----------|
| f P/R | | f P/R | |
| f CLEAR PRGM | 000, | f CLEAR PRGM | 000, |
| 1 | 001, 1 | ÷ | 001, 10 |
| 2 | 002, 2 | 1 | 002, 1 |
| ÷ | 003, 10 | 2 | 003, 2 |
| STO 1 | 004, 44 1 | = | 004, 36 |
| X↔Y | 005, 34 | STO 1 | 005, 44 1 |
| STO 2 | 006, 44 2 | X↔Y | 006, 34 |
| 1 | 007, 1 | STO 2 | 007, 44 2 |
| - | 008, 30 | - | 008, 30 |
| STO 0 | 009, 44 0 | 1 | 009, 1 |

180 Section 13: Investment Analysis

| KEYSTROKES (RPN mode) | DISPLAY | KEYSTROKES (ALG mode) | DISPLAY |
|--------------------------|------------------|--------------------------|------------------|
| 1 | 010, 1 | = | 010, 36 |
| f DB | 011, 42 25 | STO 0 | 011, 44 0 |
| RCL 1 | 012, 45 1 | 1 | 012, 1 |
| X | 013, 20 | f DB | 013, 42 25 |
| STO 3 | 014, 44 3 | X | 014, 20 |
| RCL PV | 015, 45 13 | RCL 1 | 015, 45 1 |
| x \rightrightarrows y | 016, 34 | = | 016, 36 |
| - | 017, 30 | STO 3 | 017, 44 3 |
| PV | 018, 13 | RCL PV | 018, 45 13 |
| RCL 0 | 019, 45 0 | - | 019, 30 |
| g x=0 | 020, 43 35 | x \rightrightarrows y | 020, 34 |
| g GTO 031 | 021, 43, 33, 031 | PV | 021, 13 |
| RCL 2 | 022, 45 2 | RCL 0 | 022, 45 0 |
| g PSE | 023, 43 31 | g x=0 | 023, 43 35 |
| RCL 0 | 024, 45 0 | g GTO 034 | 024, 43, 33, 034 |
| f DB | 025, 42 25 | RCL 2 | 025, 45 2 |
| R/S | 026, 31 | g PSE | 026, 43 31 |
| 1 | 027, 1 | RCL 0 | 027, 45 0 |
| STO (+) 0 | 028, 44 40 0 | f DB | 028, 42 25 |
| STO (+) 2 | 029, 44 40 2 | R/S | 029, 31 |
| g GTO 022 | 030, 43, 33, 022 | 1 | 030, 1 |
| RCL 2 | 031, 45 2 | STO (+) 0 | 031, 44 40 0 |
| g PSE | 032, 43 31 | STO (+) 2 | 032, 44 40 2 |
| RCL PV | 033, 45 13 | g GTO 025 | 033, 43, 33, 025 |

| KEYSTROKES (RPN mode) | DISPLAY | KEYSTROKES (ALG mode) | DISPLAY |
|---|------------------|---|------------------|
| $\boxed{\text{RCL}} \boxed{\text{FV}}$ | 034, 45 15 | $\boxed{\text{RCL}} 2$ | 034, 45 2 |
| $\boxed{-}$ | 035, 30 | $\boxed{\text{g}} \boxed{\text{PSE}}$ | 035, 43 31 |
| $\boxed{\text{RCL}} 3$ | 036, 45 3 | $\boxed{\text{RCL}} \boxed{\text{PV}}$ | 036, 45 13 |
| $\boxed{\text{g}} \boxed{\text{GTO}} 026$ | 037, 43, 33, 026 | $\boxed{-}$ | 037, 30 |
| $\boxed{\text{f}} \boxed{\text{P/R}}$ | | $\boxed{\text{RCL}} \boxed{\text{FV}}$ | 038, 45 15 |
| | | $\boxed{=}$ | 039, 36 |
| | | $\boxed{\text{RCL}} 3$ | 040, 45 3 |
| | | $\boxed{\text{g}} \boxed{\text{GTO}} 029$ | 041, 43, 33, 029 |
| | | $\boxed{\text{f}} \boxed{\text{P/R}}$ | |

| REGISTERS | | | |
|---|---|---------------------------|--------------------------|
| n: Life | i: Factor | PV: Dep. Value | PMT: Unused |
| FV: Salvage | R ₀ : Used | R ₁ : #Mos./12 | R ₂ : Counter |
| R ₃ : 1 st Yr. Dep. | R ₄ -R ₄ : Unused | | |

1. Key in the program.
2. Press $\boxed{\text{f}} \boxed{\text{CLEAR}} \boxed{\text{FIN}}$.
3. Key in the book value then press $\boxed{\text{PV}}$.
4. Key in the salvage value then press $\boxed{\text{FV}}$.
5. Key in the declining-balance factor as a percentage then press $\boxed{\text{i}}$.
6. Key in the life in years (an integer) then press $\boxed{\text{n}}$.

RPN Mode:

7. Key in the year desired then press **ENTER**.
8. Key in the number of months in first year* and press **R/S**.† The display will show the amount of depreciation for the desired year. Press **X↔Y** to see the remaining depreciable value. If desired, press **RCL PV RCL 3 + X↔Y - RCL FV -** to find the total depreciation through the current year.

ALG Mode:

7. Key in the year desired then press **=**.
8. Key in the number of months in first year* and press **R/S**.† The display will show the amount of depreciation for the desired year. Press **X↔Y** to see the remaining depreciable value. If desired, press **RCL PV + RCL 3 - X↔Y - RCL FV =** to find the total depreciation through the current year.

9. Press **R/S** for the amount of depreciation then, if desired, press **X↔Y** for the remaining depreciable value for the next year. Repeat this step for the following years.

10. For a new case press **g GTO 000** and return to step 2.

Example: An electron beam welder which costs \$50,000 is purchased 4 months before the end of the accounting year. What will the depreciation be during the first full accounting year (year 2) if the welder has a 6-year depreciable life, a salvage value of \$8,000 and is depreciated using the declining-balance depreciation method? The declining-balance factor is 150%.

| Keystrokes (RPN mode) | Keystrokes (ALG mode) | Display | |
|----------------------------------|----------------------------------|-----------|---------------------------|
| f RPN | f ALG | | |
| f CLEAR FIN | f CLEAR FIN | | |
| 50000 PV | 50000 PV | 50,000.00 | Book value. |
| 8000 FV | 8000 FV | 8,000.00 | Salvage value. |
| 150 i | 150 i | 150.00 | Declining-balance factor. |
| 6 n | 6 n | 6.00 | Life. |
| 2 ENTER | 2 = | 2.00 | Year desired. |

* Refer to straight-line depreciation instruction note, page 177.

† The display will pause showing the year number before showing the amount of depreciation for that year.

| Keystrokes (RPN mode) | Keystrokes (ALG mode) | Display | |
|-----------------------|-----------------------|-------------------|-------------------------------|
| 4[R/S] | 4[R/S] | 2.00 11,458.33 | Second year: depreciation. |

Sum-of-the-Years-Digits Depreciation

The following hp 12c platinum program calculates the sum-of-the-years-digits depreciation for the year desired with the acquisition date occurring at any time during the year.

| KEYSTROKES (RPN mode) | DISPLAY | KEYSTROKES (ALG mode) | DISPLAY |
|-----------------------|-------------|-----------------------|-------------|
| f P/R | | f P/R | |
| f CLEAR PRGM | 000 , | f CLEAR PRGM | 000 , |
| 1 | 001 , 1 | ÷ | 001 , 10 |
| 2 | 002 , 2 | 1 | 002 , 1 |
| ÷ | 003 , 10 | 2 | 003 , 2 |
| STO 1 | 004 , 44 1 | = | 004 , 36 |
| X↔Y | 005 , 34 | STO 1 | 005 , 44 1 |
| STO 2 | 006 , 44 2 | X↔Y | 006 , 34 |
| 1 | 007 , 1 | STO 2 | 007 , 44 2 |
| − | 008 , 30 | − | 008 , 30 |
| STO 0 | 009 , 44 0 | 1 | 009 , 1 |
| 1 | 010 , 1 | = | 010 , 36 |
| f SOYD | 011 , 42 24 | STO 0 | 011 , 44 0 |
| RCL 1 | 012 , 45 1 | 1 | 012 , 1 |
| X | 013 , 20 | f SOYD | 013 , 42 24 |
| STO 3 | 014 , 44 3 | X | 014 , 20 |
| RCL PV | 015 , 45 13 | RCL 1 | 015 , 45 1 |
| X↔Y | 016 , 34 | = | 016 , 36 |

184 Section 13: Investment Analysis

| KEYSTROKES (RPN mode) | DISPLAY | KEYSTROKES (ALG mode) | DISPLAY |
|----------------------------|------------------|----------------------------|------------------|
| \square | 017, 30 | \square 3 | 017, 44 3 |
| \square PV | 018, 13 | \square \square PV | 018, 45 13 |
| \square \square n | 019, 45 11 | \square | 019, 30 |
| \square \square 1 | 020, 45 1 | \square x \square y | 020, 34 |
| \square | 021, 30 | \square PV | 021, 13 |
| \square n | 022, 11 | \square \square n | 022, 45 11 |
| \square \square 0 | 023, 45 0 | \square | 023, 30 |
| \square \square x=0 | 024, 43 35 | \square \square 1 | 024, 45 1 |
| \square \square GTO035 | 025, 43, 33, 035 | \square n | 025, 11 |
| \square \square 2 | 026, 45 2 | \square \square 0 | 026, 45 0 |
| \square \square PSE | 027, 43 31 | \square \square x=0 | 027, 43 35 |
| \square \square 0 | 028, 45 0 | \square \square GTO038 | 028, 43, 33, 038 |
| \square \square SOYD | 029, 42 24 | \square \square 2 | 029, 45 2 |
| \square R/S | 030, 31 | \square \square PSE | 030, 43 31 |
| 1 | 031, 1 | \square \square 0 | 031, 45 0 |
| \square \square +0 | 032, 44 40 0 | \square \square SOYD | 032, 42 24 |
| \square \square +2 | 033, 44 40 2 | \square R/S | 033, 31 |
| \square \square GTO026 | 034, 43, 33, 026 | 1 | 034, 1 |
| \square \square 2 | 035, 45 2 | \square \square +0 | 035, 44 40 0 |
| \square \square PSE | 036, 43 31 | \square \square +2 | 036, 44 40 2 |
| \square \square PV | 037, 45 13 | \square \square GTO029 | 037, 43, 33, 029 |
| \square \square FV | 038, 45 15 | \square \square 2 | 038, 45 2 |
| \square | 039, 30 | \square \square PSE | 039, 43 31 |
| \square \square 3 | 040, 45 3 | \square \square PV | 040, 45 13 |

| KEYSTROKES (RPN mode) | DISPLAY | KEYSTROKES (ALG mode) | DISPLAY |
|-------------------------------|------------------|-------------------------------|------------------|
| \boxed{g} \boxed{GTO} 030 | 041, 43, 33, 030 | $\boxed{-}$ | 041, 30 |
| \boxed{f} $\boxed{P/R}$ | | \boxed{RCL} \boxed{FV} | 042, 45 15 |
| | | $\boxed{=}$ | 043, 36 |
| | | \boxed{RCL} 3 | 044, 45 3 |
| | | \boxed{g} \boxed{GTO} 033 | 045, 43, 33, 033 |
| | | \boxed{f} $\boxed{P/R}$ | |

| REGISTERS | | | |
|---|---|---------------------------|--------------------------|
| n: Life | i: Unused | PV: Dep. Value | PMT: Unused |
| FV: Salvage | R ₀ : Used | R ₁ : #Mos./12 | R ₂ : Counter |
| R ₃ : 1 st Yr. Dep. | R ₄ -R ₄ : Unused | | |

1. Key in the program.
2. Press \boxed{f} CLEAR \boxed{FIN} .
3. Key in the book value then press \boxed{PV} .
4. Key in the salvage value then press \boxed{FV} .
5. Key in the life in years (an integer) then press \boxed{n} .

RPN Mode:

6. Key in the year desired then press **ENTER**.
7. Key in the number of months in first year* then press **R/S**.† The display will show the amount of depreciation for the desired year. If desired, press **X \leftrightarrow Y** to see the remaining depreciable value, then press **RCL PV** **RCL 3** **+** **X \leftrightarrow Y** **-** **RCL FV** **-** to find the total depreciation through the current year.

ALG Mode:

6. Key in the year desired then press **=**.
7. Key in the number of months in first year* then press **R/S**.† The display will show the amount of depreciation for the desired year. If desired, press **X \leftrightarrow Y** to see the remaining depreciable value, then press **RCL PV** **+** **RCL 3** **-** **X \leftrightarrow Y** **-** **RCL FV** **=** to find the total depreciation through the current year.

8. Press **R/S** for the amount of depreciation then, if desired, press **X \leftrightarrow Y** for the remaining depreciable value for the next year. Repeat this step for the following years.
9. For a new case press **g** **GTO** **000** and return to step 2.

Example: A commercial movie camera is purchased for \$12,000. If maintained properly, the camera has a useful life expectancy of 25 years with \$500 salvage value. Using the sum-of-the-years-digits method, what is the amount of depreciation and the remaining depreciable value for the 4th and 5th years? Assume the first depreciation year is 11 months long.

| Keystrokes (RPN mode) | Keystrokes (ALG mode) | Display | |
|----------------------------------|----------------------------------|-----------|----------------|
| f RPN | f ALG | | |
| f CLEAR FIN | f CLEAR FIN | | |
| 12000 PV | 12000 PV | 12,000.00 | Book value. |
| 500 FV | 500 FV | 500.00 | Salvage value. |
| 25 n | 25 n | 25.00 | Life. |
| 4 ENTER | 4 = | 4.00 | Year desired. |

* Refer to straight-line depreciation instruction note, page 177.

† The display will pause showing the year number before showing the amount of depreciation for that year.

| Keystrokes (RPN mode) | Keystrokes (ALG mode) | Display | |
|-----------------------|-----------------------|----------------------------|--|
| 11 R/S X≧y | 11 R/S X≧y | 4.00 781.41 8,238.71 | Fourth year: depreciation, remaining depreciable value. |
| R/S X≧y | R/S X≧y | 5.00 746.02 7,492.69 | Fifth year: depreciation, remaining depreciable value. |

Full- and Partial-Year Depreciation with Crossover

When calculating declining-balance depreciation it is often advantageous for tax purposes to switch from declining balance to straight-line depreciation at some point. This hp 12c platinum program calculates the optimum crossover point and automatically switches to straight-line depreciation at the appropriate time. The crossover point is the end of the year in which the declining-balance depreciation last exceeds or equals the amount of straight-line depreciation. The straight-line depreciation is determined by dividing the remaining depreciable value by the remaining useful life.

Given the desired year and the number of months in the first year, this program calculates the depreciation for the desired year, the remaining depreciable value, and the total depreciation through the current year.

| KEYSTROKES (RPN mode) | DISPLAY | KEYSTROKES (ALG mode) | DISPLAY |
|-----------------------|------------|-----------------------|------------|
| f P/R | | f P/R | |
| f CLEAR PRGM | 000, | f CLEAR PRGM | 000, |
| 1 | 001, 1 | ÷ | 001, 10 |
| 2 | 002, 2 | 1 | 002, 1 |
| ÷ | 003, 10 | 2 | 003, 2 |
| STO 6 | 004, 44 6 | = | 004, 36 |
| RCL n | 005, 45 11 | STO 6 | 005, 44 6 |
| X≧y | 006, 34 | RCL n | 006, 45 11 |

188 Section 13: Investment Analysis

| KEYSTROKES (RPN mode) | DISPLAY | KEYSTROKES (ALG mode) | DISPLAY |
|--|--------------|--|--------------|
| $\boxed{-}$ | 007, 30 | $\boxed{-}$ | 007, 30 |
| $\boxed{\text{STO}}\boxed{4}$ | 008, 44 4 | $\boxed{\times\div y}$ | 008, 34 |
| $\boxed{\text{R}}\boxed{\downarrow}$ | 009, 33 | $\boxed{=}$ | 009, 36 |
| $\boxed{\text{STO}}\boxed{0}$ | 010, 44 0 | $\boxed{\text{STO}}\boxed{4}$ | 010, 44 4 |
| 1 | 011, 1 | $\boxed{\text{R}}\boxed{\downarrow}$ | 011, 33 |
| $\boxed{\text{STO}}\boxed{-}\boxed{0}$ | 012, 44 30 0 | $\boxed{\text{R}}\boxed{\downarrow}$ | 012, 33 |
| $\boxed{\text{STO}}\boxed{2}$ | 013, 44 2 | $\boxed{\text{STO}}\boxed{0}$ | 013, 44 0 |
| $\boxed{\text{STO}}\boxed{3}$ | 014, 44 3 | 1 | 014, 1 |
| $\boxed{f}\boxed{\text{DB}}$ | 015, 42 25 | $\boxed{\text{STO}}\boxed{-}\boxed{0}$ | 015, 44 30 0 |
| $\boxed{\text{RCL}}\boxed{6}$ | 016, 45 6 | $\boxed{\text{STO}}\boxed{2}$ | 016, 44 2 |
| $\boxed{\text{X}}$ | 017, 20 | $\boxed{\text{STO}}\boxed{3}$ | 017, 44 3 |
| $\boxed{\text{STO}}\boxed{1}$ | 018, 44 1 | $\boxed{f}\boxed{\text{DB}}$ | 018, 42 25 |
| $\boxed{\text{RCL}}\boxed{\text{PV}}$ | 019, 45 13 | $\boxed{\text{X}}$ | 019, 20 |
| $\boxed{\times\div y}$ | 020, 34 | $\boxed{\text{RCL}}\boxed{6}$ | 020, 45 6 |
| $\boxed{-}$ | 021, 30 | $\boxed{=}$ | 021, 36 |
| $\boxed{\text{PV}}$ | 022, 13 | $\boxed{\text{STO}}\boxed{1}$ | 022, 44 1 |
| $\boxed{\text{ENTER}}$ | 023, 36 | $\boxed{\text{RCL}}\boxed{\text{PV}}$ | 023, 45 13 |
| $\boxed{g}\boxed{\text{LSTX}}$ | 024, 43 40 | $\boxed{-}$ | 024, 30 |
| $\boxed{\times\div y}$ | 025, 34 | $\boxed{\times\div y}$ | 025, 34 |
| $\boxed{\text{RCL}}\boxed{\text{FV}}$ | 026, 45 15 | $\boxed{\text{PV}}$ | 026, 13 |
| $\boxed{-}$ | 027, 30 | $\boxed{\text{RCL}}\boxed{1}$ | 027, 45 1 |
| $\boxed{\times\div y}$ | 028, 34 | $\boxed{\text{RCL}}\boxed{\text{PV}}$ | 028, 45 13 |
| $\boxed{\text{RCL}}\boxed{0}$ | 029, 45 0 | $\boxed{-}$ | 029, 30 |
| 1 | 030, 1 | $\boxed{\text{RCL}}\boxed{\text{FV}}$ | 030, 45 15 |

| KEYSTROKES (RPN mode) | DISPLAY |
|-----------------------------|------------------|
| $\boxed{g} \boxed{x\leq y}$ | 031, 43 34 |
| $\boxed{g} \boxed{GTO} 039$ | 032, 43, 33, 039 |
| $\boxed{R\downarrow}$ | 033, 33 |
| $\boxed{R\downarrow}$ | 034, 33 |
| 1 | 035, 1 |
| $\boxed{g} \boxed{PSE}$ | 036, 43 31 |
| $\boxed{R\downarrow}$ | 037, 33 |
| $\boxed{R/S}$ | 038, 31 |
| 1 | 039, 1 |
| $\boxed{STO} \boxed{+} 2$ | 040, 44 40 2 |
| $\boxed{STO} \boxed{-} 0$ | 041, 44 30 0 |
| $\boxed{f} \boxed{DB}$ | 042, 42 25 |
| $\boxed{STO} \boxed{+} 1$ | 043, 44 40 1 |
| $\boxed{STO} 5$ | 044, 44 5 |
| $\boxed{RCL} \boxed{PV}$ | 045, 45 13 |
| $\boxed{RCL} \boxed{FV}$ | 046, 45 15 |
| $\boxed{-}$ | 047, 30 |
| $\boxed{RCL} 4$ | 048, 45 4 |
| $\boxed{\div}$ | 049, 10 |
| $\boxed{g} \boxed{x\leq y}$ | 050, 43 34 |
| $\boxed{g} \boxed{GTO} 053$ | 051, 43, 33, 053 |
| $\boxed{g} \boxed{GTO} 065$ | 052, 43, 33, 065 |
| $\boxed{R\downarrow}$ | 053, 33 |
| 0 | 054, 0 |

| KEYSTROKES (ALG mode) | DISPLAY |
|-----------------------------|------------------|
| $\boxed{=}$ | 031, 36 |
| $\boxed{x\geq y}$ | 032, 34 |
| $\boxed{RCL} 0$ | 033, 45 0 |
| 1 | 034, 1 |
| $\boxed{g} \boxed{x\leq y}$ | 035, 43 34 |
| $\boxed{g} \boxed{GTO} 043$ | 036, 43, 33, 043 |
| $\boxed{R\downarrow}$ | 037, 33 |
| $\boxed{R\downarrow}$ | 038, 33 |
| 1 | 039, 1 |
| $\boxed{g} \boxed{PSE}$ | 040, 43 31 |
| $\boxed{R\downarrow}$ | 041, 33 |
| $\boxed{R/S}$ | 042, 31 |
| 1 | 043, 1 |
| $\boxed{STO} \boxed{+} 2$ | 044, 44 40 2 |
| $\boxed{STO} \boxed{-} 0$ | 045, 44 30 0 |
| $\boxed{f} \boxed{DB}$ | 046, 42 25 |
| $\boxed{STO} \boxed{+} 1$ | 047, 44 40 1 |
| $\boxed{STO} 5$ | 048, 44 5 |
| $\boxed{RCL} \boxed{PV}$ | 049, 45 13 |
| $\boxed{-}$ | 050, 30 |
| $\boxed{RCL} \boxed{FV}$ | 051, 45 15 |
| $\boxed{\div}$ | 052, 10 |
| $\boxed{RCL} 4$ | 053, 45 4 |
| $\boxed{=}$ | 054, 36 |

190 Section 13: Investment Analysis

| KEYSTROKES (RPN mode) | DISPLAY | KEYSTROKES (ALG mode) | DISPLAY |
|---|----------------|---|----------------|
| $\boxed{\text{RCL}}\boxed{0}$ | 055, 45 0 | $\boxed{\text{g}}\boxed{\text{x}\leq\text{y}}$ | 055, 43 34 |
| $\boxed{\text{g}}\boxed{\text{x}\leq\text{y}}$ | 056, 43 34 | $\boxed{\text{g}}\boxed{\text{GTO}}\boxed{058}$ | 056,43,33, 058 |
| $\boxed{\text{g}}\boxed{\text{GTO}}\boxed{086}$ | 057,43,33, 086 | $\boxed{\text{g}}\boxed{\text{GTO}}\boxed{070}$ | 057,43,33, 070 |
| $\boxed{\text{RCL}}\boxed{\text{PV}}$ | 058, 45 13 | $\boxed{\text{R}}\boxed{\downarrow}$ | 058, 33 |
| $\boxed{\text{RCL}}\boxed{5}$ | 059, 45 5 | 0 | 059, 0 |
| $\boxed{-}$ | 060, 30 | $\boxed{\text{RCL}}\boxed{0}$ | 060, 45 0 |
| $\boxed{\text{PV}}$ | 061, 13 | $\boxed{\text{g}}\boxed{\text{x}\leq\text{y}}$ | 061, 43 34 |
| 1 | 062, 1 | $\boxed{\text{g}}\boxed{\text{GTO}}\boxed{091}$ | 062,43,33, 091 |
| $\boxed{\text{STO}}\boxed{-}\boxed{4}$ | 063,44 30 4 | $\boxed{\text{RCL}}\boxed{\text{PV}}$ | 063, 45 13 |
| $\boxed{\text{g}}\boxed{\text{GTO}}\boxed{040}$ | 064,43,33, 040 | $\boxed{-}$ | 064, 30 |
| $\boxed{\text{RCL}}\boxed{4}$ | 065, 45 4 | $\boxed{\text{RCL}}\boxed{5}$ | 065, 45 5 |
| $\boxed{\text{n}}$ | 066, 11 | $\boxed{\text{PV}}$ | 066, 13 |
| 0 | 067, 0 | 1 | 067, 1 |
| $\boxed{\text{STO}}\boxed{6}$ | 068, 44 6 | $\boxed{\text{STO}}\boxed{-}\boxed{4}$ | 068,44 30 4 |
| 1 | 069, 1 | $\boxed{\text{g}}\boxed{\text{GTO}}\boxed{044}$ | 069,43,33, 044 |
| $\boxed{\text{STO}}\boxed{-}\boxed{2}$ | 070,44 30 2 | $\boxed{\text{RCL}}\boxed{4}$ | 070, 45 4 |
| $\boxed{\text{STO}}\boxed{+}\boxed{0}$ | 071,44 40 0 | $\boxed{\text{n}}$ | 071, 11 |
| $\boxed{\text{RCL}}\boxed{5}$ | 072, 45 5 | 0 | 072, 0 |
| $\boxed{\text{STO}}\boxed{-}\boxed{1}$ | 073,44 30 1 | $\boxed{\text{STO}}\boxed{6}$ | 073, 44 6 |
| $\boxed{\text{RCL}}\boxed{3}$ | 074, 45 3 | 1 | 074, 1 |
| $\boxed{\text{f}}\boxed{\text{SL}}$ | 075, 42 23 | $\boxed{\text{STO}}\boxed{-}\boxed{2}$ | 075,44 30 2 |
| $\boxed{\text{STO}}\boxed{+}\boxed{1}$ | 076,44 40 1 | $\boxed{\text{STO}}\boxed{+}\boxed{0}$ | 076,44 40 0 |
| 1 | 077, 1 | $\boxed{\text{RCL}}\boxed{5}$ | 077, 45 5 |
| $\boxed{\text{STO}}\boxed{-}\boxed{0}$ | 078,44 30 0 | $\boxed{\text{STO}}\boxed{-}\boxed{1}$ | 078,44 30 1 |

| KEYSTROKES (RPN mode) | DISPLAY |
|--------------------------|----------------|
| STO + 2 | 079,44 40 2 |
| STO + 3 | 080,44 40 3 |
| R↓ | 081, 33 |
| RCL 0 | 082, 45 0 |
| 1 | 083, 1 |
| g x<y | 084, 43 34 |
| g GTO 074 | 085,43,33, 074 |
| R↓ | 086, 33 |
| R↓ | 087, 33 |
| RCL 2 | 088, 45 2 |
| g PSE | 089, 43 31 |
| R↓ | 090, 33 |
| R/S | 091, 31 |
| RCL 6 | 092, 45 6 |
| g x=0 | 093, 43 35 |
| g GTO 074 | 094,43,33, 074 |
| g GTO 058 | 095,43,33, 058 |
| f P/R | |
| | |
| | |
| | |
| | |
| | |

| KEYSTROKES (ALG mode) | DISPLAY |
|--------------------------|----------------|
| RCL 3 | 079, 45 3 |
| f SL | 080, 42 23 |
| STO + 1 | 081,44 40 1 |
| 1 | 082, 1 |
| STO - 0 | 083,44 30 0 |
| STO + 2 | 084,44 40 2 |
| STO + 3 | 085,44 40 3 |
| R↓ | 086, 33 |
| RCL 0 | 087, 45 0 |
| 1 | 088, 1 |
| g x<y | 089, 43 34 |
| g GTO 079 | 090,43,33, 079 |
| R↓ | 091, 33 |
| R↓ | 092, 33 |
| RCL 2 | 093, 45 2 |
| g PSE | 094, 43 31 |
| R↓ | 095, 33 |
| R/S | 096, 31 |
| RCL 6 | 097, 45 6 |
| g x=0 | 098, 43 35 |
| g GTO 079 | 099,43,33, 079 |
| g GTO 063 | 100,43,33, 063 |
| f P/R | |

| REGISTERS | | | |
|-----------------------|-----------------------|-----------------------|--------------------------|
| n: Life | i: Factor | PV: Dep. Value | PMT: Unused |
| FV: Salvage | R ₀ : Used | R ₁ : Dep. | R ₂ : Counter |
| R ₃ : Used | R ₄ : Used | R ₅ : Used | R ₆ : Used |

1. Key in the program.
2. Press $\boxed{f} \boxed{CLEAR} \boxed{REG}$.
3. Key in the book value then press \boxed{PV} .
4. Key in the salvage value then press \boxed{FV} .
5. Key in the life in years (an integer) then press \boxed{n} .
6. Key in the declining-balance factor as a percentage then press \boxed{i} .

| |
|--|
| 7. RPN: Key in the desired year and press \boxed{ENTER} . |
| 7. ALG: Key in the desired year and press $\boxed{=}$. |

8. Key in the number of months in the first year* then press $\boxed{R/S} \uparrow$ to calculate the amount of depreciation for the desired year.
9. If desired, press $\boxed{X} \boxed{\div} \boxed{V}$ to see the remaining depreciable value.
10. If desired, press $\boxed{RCL} \boxed{1}$ to see the total depreciation through the current year.
11. Continue pressing $\boxed{R/S} \ast$ to find the amount of depreciation for the successive years. Steps 9 and 10 may be repeated for each year.
12. For a new case press $\boxed{g} \boxed{GTO} \boxed{000}$ and return to step 2.

Example: An electronic instrument is purchased for \$11,000, with 6 months remaining in the current fiscal year. The instrument’s useful life is 8 years and the salvage value is expected to be \$500. Using a 200% declining-balance factor, generate a depreciation schedule for the instrument’s complete life. What is the remaining depreciable value after the first year? What is the total depreciation after the 7th year?

| Keystrokes (RPN mode) | Keystrokes (ALG mode) | Display | |
|---------------------------------------|---------------------------------------|---------|--|
| $\boxed{f} \boxed{RPN}$ | $\boxed{f} \boxed{ALG}$ | | |
| $\boxed{f} \boxed{CLEAR} \boxed{REG}$ | $\boxed{f} \boxed{CLEAR} \boxed{REG}$ | 0.00 | |

* Refer to straight-line depreciation note page 177.

† The display will pause with the year number before displaying the amount of depreciation for that year.

| Keystrokes (RPN mode) | Keystrokes (ALG mode) | Display | |
|-----------------------|-----------------------|------------------------------|--|
| 11000[PV] | 11000[PV] | 11,000.00 | Book value. |
| 500[FV] | 500[FV] | 500.00 | Salvage value. |
| 8[n] | 8[n] | 8.00 | Life. |
| 200[i] | 200[i] | 200.00 | Declining-balance factor. |
| 1[ENTER] | 1[=] | 1.00 | First year depreciation desired. |
| 6[R/S] X↔Y | 6[R/S] X↔Y | 1.00 1,375.00 9,125.00 | First year: depreciation, remaining depreciable value. |
| [R/S] | [R/S] | 2.00 2,406.25 | Second year: depreciation. |
| [R/S] | [R/S] | 3.00 1,804.69 | Third year: depreciation. |
| [R/S] | [R/S] | 4.00 1,353.51 | Fourth year: depreciation. |
| [R/S] | [R/S] | 5.00 1,015.14 | Fifth year: depreciation. |
| [R/S] | [R/S] | 6.00 761.35 | Sixth year: depreciation.* |
| [R/S] | [R/S] | 7.00 713.62 | Seventh year: depreciation. |
| [RCL]1 | [RCL]1 | 9,429.56 | Total depreciation through the seventh year. |
| [R/S] | [R/S] | 8.00 713.63 | Eight year: depreciation |
| [R/S] | [R/S] | 9.00 356.81 | Ninth year: depreciation. |

* By observation the crossover was year 6. Years 7, 8, and 9 use straight-line depreciation.

Excess Depreciation

When accelerated depreciation is used, the difference between total depreciation charged over a given period of time and the total amount that would have been charged under straight-line depreciation is called excess depreciation. To obtain excess depreciation:

RPN Mode:

1. Calculate the total depreciation then press **ENTER**.
2. Key in the depreciable amount (cost less salvage) then press **ENTER**. Key in the useful life of the asset in years then press **÷**. Key in the number of years in the income projection period then press **X** to get the total straight-line depreciation charge.
3. Press **=** to get the excess depreciation.

ALG Mode:

1. Calculate the total depreciation then press **=** **9** **(**.
2. Key in the depreciable amount (cost less salvage) then press **÷**. Key in the useful life of the asset in years then press **X**. Key in the number of years in the income projection period then press **9** **)** to get the total straight-line depreciation charge.
3. Press **=** to get the excess depreciation.

Example: What is the excess depreciation in the previous example over 7 calendar years? (Because of the partial first year, there are 6.5 years depreciation in the first 7 calendar years.)

| Keystrokes (RPN mode) | Keystrokes (ALG mode) | Display | |
|-----------------------|------------------------------------|-----------|--|
| 9429.56 ENTER | 9429.56 = 9 (| 9,429.56 | Total depreciation through seventh year. |
| 10500 ENTER | 10500 ÷ | 10,500.00 | Depreciable amount. |
| 8 ÷ | 8 X | 1,312.50 | Yearly straight-line depreciation. |
| 6.5 X | 6.5 9) | 8,531.25 | Total straight-line depreciation. |
| = | = | 898.31 | Excess depreciation |

Modified Internal Rate of Return

The traditional Internal Rate of Return (*IRR*) technique has several drawbacks which hamper its usefulness in some investment applications. The technique implicitly assumes that all cash flows are either reinvested or discounted at the computed yield rate. This assumption is financially reasonable as long as the rate is within a realistic borrowing and lending range (for example, 10% to 20%). When the *IRR* becomes significantly greater or smaller, the assumption becomes less valid and the resulting value less sound as an investment measure.

IRR also is limited by the number of times the sign of the cash flow changes (positive to negative or vice versa). For every change of sign, the *IRR* solution has the potential for an additional answer. The cash flow sequence in the example that follows has three sign changes and hence up to three potential internal rates of return. This particular example has three positive real answers: 1.86, 14.35, and 29. Although mathematically sound, multiple answers probably are meaningless as an investment measure.

This Modified Internal Rate of Return procedure (*MIRR*) is one of several *IRR* alternatives which avoids the drawbacks of the traditional *IRR* technique. The procedure eliminates the sign change problem and the reinvestment (or discounting) assumption by utilizing user stipulated reinvestment and borrowing rates.

Negative cash flows are discounted at a safe rate that reflects the return on an investment in a liquid account. The figure generally used is a short-term security (T-Bill) or bank passbook rate.

Positive cash flows are reinvested at a reinvestment rate which reflects the return on an investment of comparable risk. An average return rate on recent market investments might be used.

The steps in the procedure are:

1. Calculate the future value of the positive cash flows (*NFV*) at the reinvestment rate.
2. Calculate the present value of the negative cash flows (*NPV*) at the safe rate.
3. Knowing n , PV , and FV , solve for i .

196 Section 13: Investment Analysis

Example: An investor has the following unconventional investment opportunity. The cash flows are:

| Group | # of Months | Cash Flow (\$) |
|-------|-------------|----------------|
| 0 | 1 | -180,000 |
| 1 | 5 | 100,000 |
| 2 | 5 | -100,000 |
| 3 | 9 | 0 |
| 4 | 1 | 200,000 |

Calculate the *MIRR* using a safe rate of 6% and a reinvestment (risk) rate of 10%.

| Keystrokes (RPN mode) | Keystrokes (ALG mode) | Display | |
|---|---|-------------|----------------------------------|
| f RPN | f ALG | | |
| f CLEAR REG | f CLEAR REG | 0.00 | |
| 0 g CF ₀ | 0 g CF ₀ | 0.00 | First cash flow. |
| 100000 g CF ₁ | 100000 g CF ₁ | 100,000.00 | |
| 5 g N ₁ | 5 g N ₁ | 5.00 | Second through sixth cash flows. |
| 0 g CF ₁ 5 g N ₁ | 0 g CF ₁ 5 g N ₁ | 5.00 | Next five cash flows. |
| 0 g CF ₁ 9 g N ₁ | 0 g CF ₁ 9 g N ₁ | 9.00 | Next nine cash flows. |
| 200000 g CF ₁ | 200000 g CF ₁ | 200,000.00 | Last cash flow. |
| 10 g 12÷ f NPV | 10 g 12÷ f NPV | 657,152.37 | NPV of positive cash flows. |
| CHS PV | CHS PV | -657,152.37 | |
| 20 n FV | 20 n FV | 775,797.83 | NFV of positive cash flows. |
| 180000 CHS g CF ₀ 0 g CF ₁ 5 g N ₁ 100000 CHS g CF ₁ 5 g N ₁ 6 g 12÷ f NPV | 180000 CHS g CF ₀ 0 g CF ₁ 5 g N ₁ 100000 CHS g CF ₁ 5 g N ₁ 6 g 12÷ f NPV | -660,454.55 | NPV of negative cash flows. |
| 20 n i | 20 n i | 0.81 | Monthly <i>MIRR</i> |
| 12 X | X 12 = | 9.70 | Annual <i>MIRR</i> . |

Black-Scholes Formula for Valuing European Options

This program implements the Black-Scholes formula which has been used extensively in option markets worldwide since its publication in the early 1970's. The five inputs are simply keyed into the five financial variables and then $\boxed{R/S}$ displays the call option value, and $\boxed{X \approx Y}$ shows the put option value. The option values produced are accurate to at least the nearest cent for asset and strike prices under \$100.

Reference: Tony Hutchins, 2003, *Black-Scholes takes over the HP12C*, HPCC (www.hpcc.org) Datafile, V22, N3, pp13-21.

| KEYSTROKES (RPN mode) | DISPLAY | KEYSTROKES (ALG mode) | DISPLAY |
|--|-------------|--|-------------|
| \boxed{f} $\boxed{P/R}$ | | \boxed{f} $\boxed{P/R}$ | |
| \boxed{f} \boxed{CLEAR} \boxed{PRGM} | 000 , | \boxed{f} \boxed{CLEAR} \boxed{PRGM} | 000 , |
| \boxed{RCL} \boxed{n} | 001 , 45 11 | \boxed{RCL} \boxed{n} | 001 , 45 11 |
| \boxed{RCL} \boxed{i} | 002 , 45 12 | \boxed{X} | 002 , 20 |
| $\boxed{\%}$ | 003 , 25 | \boxed{RCL} \boxed{i} | 003 , 45 12 |
| \boxed{CHS} | 004 , 16 | $\boxed{\%}$ | 004 , 25 |
| \boxed{g} $\boxed{e^x}$ | 005 , 43 22 | $\boxed{=}$ | 005 , 36 |
| \boxed{RCL} \boxed{FV} | 006 , 45 15 | \boxed{CHS} | 006 , 16 |
| \boxed{X} | 007 , 20 | \boxed{g} $\boxed{e^x}$ | 007 , 43 22 |
| \boxed{STO} $\boxed{4}$ | 008 , 44 4 | \boxed{X} | 008 , 20 |
| $\boxed{X \approx Y}$ | 009 , 34 | \boxed{RCL} \boxed{FV} | 009 , 45 15 |
| \boxed{g} $\boxed{\sqrt{x}}$ | 010 , 43 21 | $\boxed{=}$ | 010 , 36 |
| \boxed{RCL} \boxed{PMT} | 011 , 45 14 | \boxed{STO} $\boxed{4}$ | 011 , 44 4 |
| $\boxed{\%}$ | 012 , 25 | \boxed{RCL} \boxed{n} | 012 , 45 11 |
| \boxed{STO} $\boxed{3}$ | 013 , 44 3 | \boxed{g} $\boxed{\sqrt{x}}$ | 013 , 43 21 |
| \boxed{RCL} \boxed{PV} | 014 , 45 13 | \boxed{X} | 014 , 20 |
| \boxed{RCL} $\boxed{4}$ | 015 , 45 4 | \boxed{RCL} \boxed{PMT} | 015 , 45 14 |
| $\boxed{\div}$ | 016 , 10 | $\boxed{\%}$ | 016 , 25 |

198 Section 13: Investment Analysis

| KEYSTROKES (RPN mode) | DISPLAY | KEYSTROKES (ALG mode) | DISPLAY |
|------------------------------|------------|--------------------------|------------|
| $\boxed{g} \boxed{LN}$ | 017, 43 23 | $\boxed{=}$ | 017, 36 |
| $\boxed{x \div y}$ | 018, 34 | $\boxed{STO} \boxed{3}$ | 018, 44 3 |
| $\boxed{\div}$ | 019, 10 | $\boxed{RCL} \boxed{PV}$ | 019, 45 13 |
| $\boxed{g} \boxed{LSTx}$ | 020, 43 40 | $\boxed{\div}$ | 020, 10 |
| 2 | 021, 2 | $\boxed{RCL} \boxed{4}$ | 021, 45 4 |
| $\boxed{STO} \boxed{5}$ | 022, 44 5 | $\boxed{=}$ | 022, 36 |
| $\boxed{\div}$ | 023, 10 | $\boxed{g} \boxed{LN}$ | 023, 43 23 |
| $\boxed{+}$ | 024, 40 | $\boxed{\div}$ | 024, 10 |
| $\boxed{STO} \boxed{6}$ | 025, 44 6 | $\boxed{x \div y}$ | 025, 34 |
| $\boxed{RCL} \boxed{3}$ | 026, 45 3 | $\boxed{=}$ | 026, 36 |
| $\boxed{-}$ | 027, 30 | $\boxed{RCL} \boxed{3}$ | 027, 45 3 |
| $\boxed{STO} \boxed{3}$ | 028, 44 3 | $\boxed{\div}$ | 028, 10 |
| \boxed{ENTER} | 029, 36 | 2 | 029, 2 |
| \boxed{X} | 030, 20 | $\boxed{STO} \boxed{5}$ | 030, 44 5 |
| $\boxed{g} \boxed{\sqrt{x}}$ | 031, 43 21 | $\boxed{+}$ | 031, 40 |
| $\boxed{g} \boxed{LSTx}$ | 032, 43 40 | $\boxed{x \div y}$ | 032, 34 |
| 2 | 033, 2 | $\boxed{-}$ | 033, 30 |
| $\boxed{\div}$ | 034, 10 | $\boxed{STO} \boxed{6}$ | 034, 44 6 |
| \boxed{CHS} | 035, 16 | $\boxed{RCL} \boxed{3}$ | 035, 45 3 |
| $\boxed{g} \boxed{e^x}$ | 036, 43 22 | $\boxed{=}$ | 036, 36 |
| $\boxed{x \div y}$ | 037, 34 | $\boxed{STO} \boxed{3}$ | 037, 44 3 |
| 3 | 038, 3 | $\boxed{g} \boxed{x^2}$ | 038, 43 20 |
| $\boxed{\cdot}$ | 039, 48 | $\boxed{\div}$ | 039, 10 |
| 0 | 040, 0 | 2 | 040, 2 |

| KEYSTROKES (RPN mode) | DISPLAY | KEYSTROKES (ALG mode) | DISPLAY |
|--------------------------|------------|--------------------------|------------|
| 0 | 041, 0 | = | 041, 36 |
| 6 | 042, 6 | CHS | 042, 16 |
| \div | 043, 10 | g e^x | 043, 43 22 |
| 1 | 044, 1 | RCL 3 | 044, 45 3 |
| $+$ | 045, 40 | g x^2 | 045, 43 20 |
| $\frac{1}{x}$ | 046, 22 | g \sqrt{x} | 046, 43 21 |
| \times | 047, 20 | \div | 047, 10 |
| g LSTx | 048, 43 40 | 3 | 048, 3 |
| g LSTx | 049, 43 40 | \cdot | 049, 48 |
| 1 | 050, 1 | 0 | 050, 0 |
| 8 | 051, 8 | 0 | 051, 0 |
| 7 | 052, 7 | 6 | 052, 6 |
| \times | 053, 20 | $+$ | 053, 40 |
| 2 | 054, 2 | 1 | 054, 1 |
| 4 | 055, 4 | = | 055, 36 |
| $-$ | 056, 30 | $\frac{1}{x}$ | 056, 22 |
| \times | 057, 20 | STO 2 | 057, 44 2 |
| 8 | 058, 8 | \times | 058, 20 |
| 7 | 059, 7 | $x \div y$ | 059, 34 |
| $+$ | 060, 40 | = | 060, 36 |
| \times | 061, 20 | 1 | 061, 1 |
| \cdot | 062, 48 | 8 | 062, 8 |
| 2 | 063, 2 | 7 | 063, 7 |
| $\%$ | 064, 25 | \times | 064, 20 |

200 Section 13: Investment Analysis

| KEYSTROKES (RPN mode) | DISPLAY | KEYSTROKES (ALG mode) | DISPLAY |
|---|------------------|---|------------------|
| $\boxed{\text{RCL}}\ 3$ | 065, 45 3 | $\boxed{\text{RCL}}\ 2$ | 065, 45 2 |
| $\boxed{\times\ y}$ | 066, 34 | $\boxed{-}$ | 066, 30 |
| $\boxed{\text{STO}}\ 3$ | 067, 44 3 | 2 | 067, 2 |
| $\boxed{\text{CLx}}$ | 068, 35 | 4 | 068, 4 |
| $\boxed{\times\ y}$ | 069, 34 | $\boxed{\times}$ | 069, 20 |
| $\boxed{\text{g}}\ \boxed{\times\ y}$ | 070, 43 34 | $\boxed{\text{RCL}}\ 2$ | 070, 45 2 |
| $\boxed{\text{g}}\ \boxed{\text{GTO}}\ 077$ | 071, 43, 33, 077 | $\boxed{+}$ | 071, 40 |
| 1 | 072, 1 | 8 | 072, 8 |
| $\boxed{\text{STO}}\ \boxed{-}\ 3$ | 073, 44 30 3 | 7 | 073, 7 |
| $\boxed{\text{CHS}}$ | 074, 16 | $\boxed{\times}$ | 074, 20 |
| $\boxed{\text{STO}}\ \boxed{\times}\ 3$ | 075, 44 20 3 | $\boxed{\times\ y}$ | 075, 34 |
| $\boxed{\times\ y}$ | 076, 34 | $\boxed{\times}$ | 076, 20 |
| $\boxed{\text{RCL}}\ 5$ | 077, 45 5 | $\boxed{\cdot}$ | 077, 48 |
| $\boxed{\text{g}}\ \boxed{\times=0}$ | 078, 43 35 | 2 | 078, 2 |
| $\boxed{\text{g}}\ \boxed{\text{GTO}}\ 089$ | 079, 43, 33, 089 | $\boxed{\%}$ | 079, 25 |
| $\boxed{\text{RCL}}\ 6$ | 080, 45 6 | $\boxed{=}$ | 080, 36 |
| $\boxed{\text{RCL}}\ 3$ | 081, 45 3 | $\boxed{\text{RCL}}\ 3$ | 081, 45 3 |
| $\boxed{\text{RCL}}\ 4$ | 082, 45 4 | $\boxed{\times\ y}$ | 082, 34 |
| $\boxed{\times}$ | 083, 20 | $\boxed{\text{STO}}\ 3$ | 083, 44 3 |
| $\boxed{\text{STO}}\ 6$ | 084, 44 6 | $\boxed{\text{CLx}}$ | 084, 35 |
| $\boxed{\text{CLx}}$ | 085, 35 | $\boxed{\times\ y}$ | 085, 34 |
| $\boxed{\text{STO}}\ 5$ | 086, 44 5 | $\boxed{\text{g}}\ \boxed{\times\ y}$ | 086, 43 34 |
| $\boxed{\times\ y}$ | 087, 34 | $\boxed{\text{g}}\ \boxed{\text{GTO}}\ 093$ | 087, 43, 33, 093 |
| $\boxed{\text{g}}\ \boxed{\text{GTO}}\ 028$ | 088, 43, 33, 028 | 1 | 088, 1 |

| KEYSTROKES (RPN mode) | DISPLAY | KEYSTROKES (ALG mode) | DISPLAY |
|--|-------------|---|----------------|
| $\boxed{\times\div y}$ | 089, 34 | $\boxed{\text{STO}}\boxed{-}\boxed{3}$ | 089,44 30 3 |
| $\boxed{\text{RCL}}\boxed{3}$ | 090, 45 3 | $\boxed{\text{CHS}}$ | 090, 16 |
| $\boxed{\text{RCL}}\boxed{\text{PV}}$ | 091, 45 13 | $\boxed{\text{STO}}\boxed{\times}\boxed{3}$ | 091,44 20 3 |
| $\boxed{\text{STO}}\boxed{-}\boxed{4}$ | 092,44 30 4 | $\boxed{\times\div y}$ | 092, 34 |
| $\boxed{\times}$ | 093, 20 | $\boxed{\text{RCL}}\boxed{5}$ | 093, 45 5 |
| $\boxed{\text{RCL}}\boxed{6}$ | 094, 45 6 | $\boxed{g}\boxed{\times=0}$ | 094, 43 35 |
| $\boxed{-}$ | 095, 30 | $\boxed{g}\boxed{\text{GTO}}\boxed{106}$ | 095,43,33, 106 |
| $\boxed{\text{STO}}\boxed{+}\boxed{4}$ | 096,44 40 4 | $\boxed{\text{RCL}}\boxed{6}$ | 096, 45 6 |
| $\boxed{\text{RCL}}\boxed{4}$ | 097, 45 4 | $\boxed{\text{RCL}}\boxed{3}$ | 097, 45 3 |
| $\boxed{\times\div y}$ | 098, 34 | $\boxed{\times}$ | 098, 20 |
| $\boxed{\text{STO}}\boxed{5}$ | 099, 44 5 | $\boxed{\text{RCL}}\boxed{4}$ | 099, 45 4 |
| $\boxed{f}\boxed{\text{P/R}}$ | | $\boxed{=}$ | 100, 36 |
| | | $\boxed{\text{STO}}\boxed{6}$ | 101, 44 6 |
| | | $\boxed{\text{CLx}}$ | 102, 35 |
| | | $\boxed{\text{STO}}\boxed{5}$ | 103, 44 5 |
| | | $\boxed{\times\div y}$ | 104, 34 |
| | | $\boxed{g}\boxed{\text{GTO}}\boxed{037}$ | 105,43,33, 037 |
| | | $\boxed{\times\div y}$ | 106, 34 |
| | | $\boxed{\text{RCL}}\boxed{\text{PV}}$ | 107, 45 13 |
| | | $\boxed{\text{STO}}\boxed{-}\boxed{4}$ | 108,44 30 4 |
| | | $\boxed{\times}$ | 109, 20 |
| | | $\boxed{\text{RCL}}\boxed{3}$ | 110, 45 3 |
| | | $\boxed{-}$ | 111, 30 |
| | | $\boxed{\text{RCL}}\boxed{6}$ | 112, 45 6 |

| KEYSTROKES (RPN mode) | DISPLAY | KEYSTROKES (ALG mode) | DISPLAY |
|--------------------------|---------|------------------------------------|------------------|
| | | $\boxed{=}$ | 113, 36 |
| | | $\boxed{\text{STO}} \boxed{+} 4$ | 114, 44 40 4 |
| | | $\boxed{\text{RCL}} 4$ | 115, 45 4 |
| | | $\boxed{\times \div Y}$ | 116, 34 |
| | | $\boxed{\text{STO}} 5$ | 117, 44 5 |
| | | $\boxed{g} \boxed{\text{GTO}} 000$ | 118, 43, 33, 000 |
| | | $\boxed{f} \boxed{\text{P/R}}$ | |

| REGISTERS | | | |
|---|----------------------------|-----------------------------|---------------------------------------|
| n: Term to expiry | i: Interest rate (%) | PV: Stock price | PMT: Volatility (%) |
| FV: Strike price | R ₀ : Unused | R ₁ : Unused | R ₂ : Unused |
| R ₃ : N(d ₁) | R ₄ : Put value | R ₅ : Call value | R ₆ : QxN(d ₂) |
| R ₇ -R ₉ : Unused | | | |

Note: The n , i and PMT values must all be based on the same *time unit* (for example: n is measured in years or months and i and PMT are rates per year or per month). i is a continuous percentage rate. PMT is the standard deviation of the continuous percentage stock return (as observed over the *time unit*). For sensible output, all inputs should be positive. The $PMT=0$ case can be simulated by using a PMT arbitrarily close to 0.

Program Instructions

- Key in the program.
- Enter the five inputs into the five financial registers. These values are preserved by the program.
 - Key in the unexpired term of the option and press \boxed{n} .
 - Key in the risk-free interest rate as a percentage and press \boxed{i} .
 - Key in the current (or spot) stock price and press $\boxed{\text{PV}}$.
 - Key in the volatility assumption as a percentage and press $\boxed{\text{PMT}}$.
 - Key in the strike price and press $\boxed{\text{FV}}$.
- Press $\boxed{\text{R/S}}$. The Call value is displayed. Press $\boxed{\times \div Y}$ to see the Put value.

Example 1: An option has 6 months to run and a strike price of \$45. Find Call and Put values assuming a spot price of \$52, return volatility of 20.54% per month and a risk-free interest rate of 0.5% per month. Show how to change the time scale of the inputs between monthly and annual values.

| Keystrokes (RPN mode) | Keystrokes (ALG mode) | Display | |
|-------------------------------|-------------------------------|---------|------------------------------|
| f RPN | f ALG | | |
| 6 n | 6 n | 6 . 00 | Time to expiry (months). |
| .5 i | .5 i | 0 . 50 | Interest rate (% per month). |
| 52 PV | 52 PV | 52 . 00 | Stock price. |
| 20.54 PMT | 20.54 PMT | 20 . 54 | Volatility (% per month). |
| 45 FV | 45 FV | 45 . 00 | Strike price. |
| R/S | R/S | 14 . 22 | Call value. |
| X↔Y | X↔Y | 5 . 89 | Put value. |
| RCL g 12X n | RCL g 12X n | 0 . 50 | Years to expiry. |
| RCL g 12÷ i | RCL g 12÷ i | 6 . 00 | Yearly interest rate %. |
| RCL PMT 12 g √x X PMT | RCL PMT X 12 g √x PMT | 71 . 15 | Yearly volatility %. |
| R/S | R/S | 14 . 22 | Call value (unchanged). |
| RCL n g 12X | RCL n g 12X | 6 . 00 | Months to expiry. |
| RCL i g 12÷ | RCL i g 12÷ | 0 . 50 | Monthly interest rate %. |
| RCL PMT 12 g √x ÷ PMT | RCL PMT ÷ 12 g √x PMT | 20 . 54 | Monthly volatility %. |

The next example is *Example 12.7* from *Options, Futures, and Other Derivatives (5th Edition)* by John C. Hull (Prentice Hall, 2002).

204 Section 13: Investment Analysis

Example 2: The stock price six months from the expiration of an option is \$42, the exercise price of the option is \$40, the risk-free interest rate is 10% per annum, and the volatility is 20% per annum. Find Call and Put values.

| Keystrokes (RPN mode) | Keystrokes (ALG mode) | Display | |
|--------------------------|--------------------------|---------|-----------------------------|
| f RPN | f ALG | | |
| .5 n | .5 n | 0 . 50 | Time to expiry (years). |
| 10 i | 10 i | 10 . 00 | Interest rate (% per year). |
| 42 PV | 42 PV | 42 . 00 | Stock price. |
| 20 PMT | 20 PMT | 20 . 00 | Volatility (% per year). |
| 40 FV | 40 FV | 40 . 00 | Strike price. |
| R/S | R/S | 4 . 76 | Call value. |
| X \Rightarrow Y | X \Rightarrow Y | 0 . 81 | Put value. |

Section 14

Leasing

Advance Payments

Situations may exist where payments are made in advance (leasing is a good example). These agreements call for extra payments to be made when the transaction is closed.

This first procedure finds the periodic payment amount necessary to achieve a desired yield when a number of payments are made in advance. And, given the periodic payment, the second procedure calculates the periodic yield.

Solving for Payment

To calculate the payment, information is entered as follows:

1. Press \boxed{g} \boxed{END} and \boxed{f} \boxed{CLEAR} \boxed{FIN} .

RPN Mode:

2. Key in the total number of payments in the lease then press \boxed{ENTER} .
3. Key in the total number of payments made in advance then press \boxed{STO} \boxed{O} $\boxed{-}$ \boxed{n} .
4. Key in or calculate the periodic interest rate as a percentage then press \boxed{i} .
5. Press 1 \boxed{CHS} \boxed{PMT} \boxed{PV} \boxed{RCL} \boxed{O} $\boxed{+}$.
6. Key in the initial loan amount then press $\boxed{\times\div}$ $\boxed{\div}$, to obtain the periodic payment to be received by the lessor.

ALG Mode:

2. Key in the total number of payments in the lease.
3. Key in the total number of payments made in advance then press $\boxed{-}$ \boxed{STO} \boxed{O} \boxed{n} .
4. Key in or calculate the periodic interest rate as a percentage then press \boxed{i} .
5. Press 1 \boxed{CHS} \boxed{PMT} \boxed{PV} $\boxed{+}$ \boxed{RCL} \boxed{O} $\boxed{=}$.
6. Key in the initial loan amount then press $\boxed{\div}$ $\boxed{\times\div}$ $\boxed{=}$, to obtain the periodic payment to be received by the lessor.

206 Section 14: Leasing

Example 1: Equipment worth \$750 is leased for 12 months. The equipment is assumed to have no salvage value at the end of the lease. The lessee has agreed to make three payments at the time of closing. What monthly payment is necessary to yield the lessor 10% annually?

| Keystrokes (RPN mode) | Keystrokes (ALG mode) | Display | |
|-----------------------|-----------------------|---------|---------------------------------|
| f RPN | f ALG | | |
| g END | g END | | |
| f CLEAR FIN | f CLEAR FIN | | |
| 12 ENTER | 12 − | 12.00 | Duration of lease. |
| 3 STO 0 − n | 3 STO 0 n | 9.00 | Number of periodic payments. |
| 10 g 12 ÷ | 10 g 12 ÷ | 0.83 | |
| 1 CHS PMT | 1 CHS PMT | −1.00 | |
| PV RCL 0 + | PV + RCL 0 = | 11.64 | |
| 750 x↔y ÷ | 750 ÷ x↔y = | 64.45 | Monthly payment to be received. |

If solving for the payment amount will be done repetitively, key in the following hp 12c platinum program.

| KEYSTROKES (RPN mode) | DISPLAY | KEYSTROKES (ALG mode) | DISPLAY |
|-----------------------|-------------|-----------------------|-------------|
| f P/R | | f P/R | |
| f CLEAR PRGM | 000 , | f CLEAR PRGM | 000 , |
| g END | 001 , 43 8 | g END | 001 , 43 8 |
| f CLEAR FIN | 002 , 42 34 | f CLEAR FIN | 002 , 42 34 |
| RCL 0 | 003 , 45 0 | RCL 0 | 003 , 45 0 |
| RCL 1 | 004 , 45 1 | − | 004 , 30 |
| − | 005 , 30 | RCL 1 | 005 , 45 1 |
| n | 006 , 11 | n | 006 , 11 |
| RCL 2 | 007 , 45 2 | RCL 2 | 007 , 45 2 |

| KEYSTROKES (RPN mode) | DISPLAY | KEYSTROKES (ALG mode) | DISPLAY |
|-------------------------------|-----------|-------------------------------|-----------|
| \boxed{i} | 008, 12 | \boxed{i} | 008, 12 |
| $\boxed{1}$ | 009, 1 | $\boxed{1}$ | 009, 1 |
| $\boxed{\text{CHS}}$ | 010, 16 | $\boxed{\text{CHS}}$ | 010, 16 |
| $\boxed{\text{PMT}}$ | 011, 14 | $\boxed{\text{PMT}}$ | 011, 14 |
| $\boxed{\text{PV}}$ | 012, 13 | $\boxed{\text{PV}}$ | 012, 13 |
| $\boxed{\text{RCL}}\boxed{1}$ | 013, 45 1 | $\boxed{+}$ | 013, 40 |
| $\boxed{+}$ | 014, 40 | $\boxed{\text{RCL}}\boxed{1}$ | 014, 45 1 |
| $\boxed{\text{RCL}}\boxed{3}$ | 015, 45 3 | $\boxed{=}$ | 015, 36 |
| $\boxed{\times\div y}$ | 016, 34 | $\boxed{\text{RCL}}\boxed{3}$ | 016, 45 3 |
| $\boxed{\div}$ | 017, 10 | $\boxed{\div}$ | 017, 10 |
| $\boxed{f}\boxed{\text{P/R}}$ | | $\boxed{\times\div y}$ | 018, 34 |
| | | $\boxed{=}$ | 019, 36 |
| | | $\boxed{f}\boxed{\text{P/R}}$ | |

| REGISTERS | | | |
|-----------------------|---|-----------------------------|--------------------|
| n: n-#Adv. Pmt. | i: i | PV: Used | PMT: -1 |
| FV: 0 | R ₀ : n | R ₁ : #Adv. Pmt. | R ₂ : i |
| R ₃ : Loan | R ₄ -R ₇ : Unused | | |

1. Key in the program.
2. Key in the total number of payments in the lease then press $\boxed{\text{STO}}\boxed{0}$.
3. Key in the total number of payments made in advance then press $\boxed{\text{STO}}\boxed{1}$.
4. Key in the periodic interest rate as a percentage then press $\boxed{\text{STO}}\boxed{2}$.
5. Key in the loan amount and press $\boxed{\text{STO}}\boxed{3}$; then press $\boxed{\text{R/S}}$ to obtain the periodic payment to be received by the lessor.
6. For a new case, return to step 2. The values changed from the previous case are the only values which need to be entered.

208 Section 14: Leasing

Example 2: Using the preceding program, solve for the monthly payment using the information given in example 1. Then change the yearly interest to 15% and solve for the new payment amount.

| Keystrokes (RPN mode) | Keystrokes (ALG mode) | Display | |
|-----------------------|-----------------------|---------|---|
| f RPN | f ALG | | |
| 12 STO 0 | 12 STO 0 | 12.00 | Duration of lease. |
| 3 STO 1 | 3 STO 1 | 3.00 | Number of advance payments. |
| 10 ENTER 12 ÷ | 10 ÷ 12 = | 0.83 | |
| STO 2 | STO 2 | 0.83 | Periodic interest rate. |
| 750 STO 3 R/S | 750 STO 3 R/S | 64.45 | Monthly payment to be received. |
| 15 ENTER 12 ÷ | 15 ÷ 12 = | 1.25 | |
| STO 2 R/S | STO 2 R/S | 65.43 | Monthly payment to achieve a 15% yield. |

Example 3: Using the information from example 1, what monthly payment is necessary to yield the lessor 15% annually if one payment is due at the time of closing?

Assuming that the previous example was just solved, the keystrokes are as follows:

| Keystrokes (RPN mode) | Keystrokes (ALG mode) | Display | |
|-----------------------|-----------------------|---------|---------------------------------|
| 1 STO 1 R/S | 1 STO 1 R/S | 66.86 | Monthly payment to be received. |

Since this problem is an annuity due situation (one payment at the beginning of the period) the calculation could also be done as follows:

| Keystrokes (RPN mode) | Keystrokes (ALG mode) | Display | |
|-----------------------|-----------------------|---------|----------------------------------|
| g BEG | g BEG | | |
| f CLEAR FIN | f CLEAR FIN | | |
| 12 n | 12 n | 12.00 | Duration of lease. |
| 15 g 12 ÷ | 15 g 12 ÷ | 1.25 | Periodic interest rate (into i). |
| 750 CHS PV PMT | 750 CHS PV PMT | 66.86 | Monthly payment to be received. |

Solving for Yield

To calculate the periodic yield, information is entered as follows:

1. Press $\boxed{g} \boxed{END}$ and $\boxed{f} \boxed{CLEAR} \boxed{FIN}$.

RPN Mode:

2. Key in the total number of payments in the lease then press \boxed{ENTER} .
3. Key in the total number of payments made in advance then press $\boxed{STO} \boxed{O} \boxed{-} \boxed{n}$.
4. Key in the periodic payment to be received then press \boxed{PMT} .
5. Key in the total amount of the loan then press $\boxed{CHS} \boxed{RCL} \boxed{O} \boxed{RCL} \boxed{PMT} \boxed{X} \boxed{+} \boxed{PV}$.
6. Press \boxed{i} to obtain the periodic yield.

ALG Mode:

2. Key in the total number of payments in the lease then press $\boxed{-}$.
3. Key in the total number of payments made in advance then press $\boxed{STO} \boxed{O} \boxed{n}$.
4. Key in the periodic payment to be received then press \boxed{PMT} .
5. Press $\boxed{RCL} \boxed{O} \boxed{X} \boxed{RCL} \boxed{PMT} \boxed{=} \boxed{+}$. Then key in the total amount of the loan and press $\boxed{CHS} \boxed{PV}$.
6. Press \boxed{i} to obtain the periodic yield.

Example 1: A lease has been written to run for 60 months. The leased equipment has a value of \$25,000 with a \$600 monthly payment. The lessee has agreed to make 3 payments at the time of closing (\$1,800). What is the annual yield to the lessor?

| Keystrokes (RPN mode) | Keystrokes (ALG mode) | Display | |
|--|--|------------|------------------------------|
| $\boxed{f} \boxed{RPN}$ | $\boxed{f} \boxed{ALG}$ | | |
| $\boxed{g} \boxed{END}$ | $\boxed{g} \boxed{END}$ | | |
| $\boxed{f} \boxed{CLEAR} \boxed{FIN}$ | $\boxed{f} \boxed{CLEAR} \boxed{FIN}$ | | |
| 60 \boxed{ENTER} 3 | 60 $\boxed{-}$ 3 | 3. | |
| $\boxed{STO} \boxed{O} \boxed{-} \boxed{n}$ | $\boxed{STO} \boxed{O} \boxed{n}$ | 57.00 | Number of periodic payments. |
| 600 \boxed{PMT} | 600 \boxed{PMT} | 600.00 | Monthly payment. |
| 25000 $\boxed{CHS} \boxed{RCL}$ 0 $\boxed{RCL} \boxed{PMT} \boxed{X}$ $\boxed{+} \boxed{PV}$ | $\boxed{RCL} \boxed{O} \boxed{X} \boxed{RCL}$ $\boxed{PMT} \boxed{+} 25000$ $\boxed{CHS} \boxed{PV}$ | -23,200.00 | PV. |

210 Section 14: Leasing

| Keystrokes (RPN mode) | Keystrokes (ALG mode) | Display | |
|-----------------------|-------------------------------|---------|---------------------------------|
| \boxed{i} | \boxed{i} | 1.44 | Monthly yield (calculated). |
| $12 \boxed{\times}$ | $\boxed{\times} 12 \boxed{=}$ | 17.33 | Annual yield (as a percentage). |

If solving for yield will be done repetitively, key in the following hp 12c platinum program:

| KEYSTROKES (RPN mode) | DISPLAY | KEYSTROKES (ALG mode) | DISPLAY |
|--|-------------|---|------------------|
| $\boxed{f} \boxed{P/R}$ | | $\boxed{f} \boxed{P/R}$ | |
| $\boxed{f} \boxed{CLEAR} \boxed{PRGM}$ | 000 , | $\boxed{f} \boxed{CLEAR} \boxed{PRGM}$ | 000 , |
| $\boxed{g} \boxed{END}$ | 001 , 43 8 | $\boxed{g} \boxed{END}$ | 001 , 43 8 |
| $\boxed{f} \boxed{CLEAR} \boxed{FIN}$ | 002 , 42 34 | $\boxed{f} \boxed{CLEAR} \boxed{FIN}$ | 002 , 42 34 |
| $\boxed{RCL} \boxed{0}$ | 003 , 45 0 | $\boxed{RCL} \boxed{0}$ | 003 , 45 0 |
| $\boxed{RCL} \boxed{1}$ | 004 , 45 1 | $\boxed{-}$ | 004 , 30 |
| $\boxed{-}$ | 005 , 30 | $\boxed{RCL} \boxed{1}$ | 005 , 45 1 |
| \boxed{n} | 006 , 11 | \boxed{n} | 006 , 11 |
| $\boxed{RCL} \boxed{2}$ | 007 , 45 2 | $\boxed{RCL} \boxed{2}$ | 007 , 45 2 |
| \boxed{PMT} | 008 , 14 | \boxed{PMT} | 008 , 14 |
| $\boxed{RCL} \boxed{3}$ | 009 , 45 3 | $\boxed{\times}$ | 009 , 20 |
| \boxed{CHS} | 010 , 16 | $\boxed{RCL} \boxed{1}$ | 010 , 45 1 |
| $\boxed{RCL} \boxed{1}$ | 011 , 45 1 | $\boxed{-}$ | 011 , 30 |
| $\boxed{RCL} \boxed{PMT}$ | 012 , 45 14 | $\boxed{RCL} \boxed{3}$ | 012 , 45 3 |
| $\boxed{\times}$ | 013 , 20 | \boxed{PV} | 013 , 13 |
| $\boxed{+}$ | 014 , 40 | \boxed{i} | 014 , 12 |
| \boxed{PV} | 015 , 13 | $\boxed{RCL} \boxed{g} \boxed{12} \boxed{\div}$ | 015 , 45 , 43 12 |
| \boxed{i} | 016 , 12 | $\boxed{f} \boxed{P/R}$ | |

| KEYSTROKES (RPN mode) | DISPLAY | KEYSTROKES (ALG mode) | DISPLAY |
|--------------------------|--------------|--------------------------|---------|
| RCL 9 12÷ | 017,45,43 12 | | |
| f P/R | | | |

| REGISTERS | | | |
|-----------------------|---|-----------------------------|-----------------------|
| n: n-#Adv. Pmts. | i: i | PV: Used | PMT: Pmt. |
| FV: 0 | R ₀ : n | R ₁ : Adv. Pmts. | R ₂ : Pmt. |
| R ₃ : Loan | R ₄ -R ₇ : Unused | | |

1. Key in the program.
2. Key in the total number of payments in the lease then press $\text{STO}0$.
3. Key in the total number of payments made in advance then press $\text{STO}1$.
4. Key in the periodic payment to be received then press $\text{STO}2$.
5. Key in the total amount of the loan, then press $\text{STO}3$; then press R/S to obtain the periodic yield.
6. For a new case, return to step 2. The values changed from the previous case are the only values which need to be re-entered.

Example 2: Using the program, solve for yield using the same information given in example 1. Then change the payment to \$625 and solve for the yield.

| Keystrokes (RPN mode) | Keystrokes (ALG mode) | Display | |
|----------------------------------|----------------------------------|---------|--|
| f RPN | f ALG | | |
| 60 $\text{STO}0$ | 60 $\text{STO}0$ | 60.00 | Number of payments. |
| 3 $\text{STO}1$ | 3 $\text{STO}1$ | 3.00 | Number of advance payments. |
| 600 $\text{STO}2$ | 600 $\text{STO}2$ | 600.00 | Periodic payment. |
| 25000 $\text{STO}3$ R/S | 25000 $\text{STO}3$ R/S | 17.33 | Annual yield (as a percentage). |
| 625 $\text{STO}2$ R/S | 625 $\text{STO}2$ R/S | 19.48 | Annual yield (as a percentage) when PMT is increased \$25. |

Advance Payments With Residual

Situations may arise where a transaction has advance payments and a residual value (salvage value) at the end of the normal term.

Solving for Payment

The following program solves for the periodic payment amount necessary to achieve a desired yield.

| KEYSTROKES (RPN mode) | DISPLAY | KEYSTROKES (ALG mode) | DISPLAY |
|--------------------------|-------------|--------------------------|-------------|
| f P/R | | f P/R | |
| f CLEAR PRGM | 000 , | f CLEAR PRGM | 000 , |
| g END | 001 , 43 8 | g END | 001 , 43 8 |
| f CLEAR FIN | 002 , 42 34 | f CLEAR FIN | 002 , 42 34 |
| RCL 0 | 003 , 45 0 | RCL 0 | 003 , 45 0 |
| n | 004 , 11 | n | 004 , 11 |
| RCL 1 | 005 , 45 1 | RCL 1 | 005 , 45 1 |
| i | 006 , 12 | i | 006 , 12 |
| RCL 3 | 007 , 45 3 | RCL 3 | 007 , 45 3 |
| FV | 008 , 15 | FV | 008 , 15 |
| PV | 009 , 13 | PV | 009 , 13 |
| RCL 2 | 010 , 45 2 | + | 010 , 40 |
| + | 011 , 40 | RCL 2 | 011 , 45 2 |
| STO 5 | 012 , 44 5 | = | 012 , 36 |
| 0 | 013 , 0 | STO 5 | 013 , 44 5 |
| FV | 014 , 15 | 0 | 014 , 0 |
| RCL n | 015 , 45 11 | FV | 015 , 15 |
| RCL 4 | 016 , 45 4 | RCL n | 016 , 45 11 |
| - | 017 , 30 | - | 017 , 30 |

| KEYSTROKES (RPN mode) | DISPLAY | KEYSTROKES (ALG mode) | DISPLAY |
|--------------------------|-----------|--------------------------|-----------|
| \boxed{n} | 018, 11 | $\boxed{RCL}4$ | 018, 45 4 |
| 1 | 019, 1 | \boxed{n} | 019, 11 |
| \boxed{CHS} | 020, 16 | 1 | 020, 1 |
| \boxed{PMT} | 021, 14 | \boxed{CHS} | 021, 16 |
| \boxed{PV} | 022, 13 | \boxed{PMT} | 022, 14 |
| $\boxed{RCL}4$ | 023, 45 4 | \boxed{PV} | 023, 13 |
| $\boxed{+}$ | 024, 40 | $\boxed{+}$ | 024, 40 |
| $\boxed{RCL}5$ | 025, 45 5 | $\boxed{RCL}4$ | 025, 45 4 |
| $\boxed{x\div y}$ | 026, 34 | $\boxed{=}$ | 026, 36 |
| $\boxed{\div}$ | 027, 10 | $\boxed{RCL}5$ | 027, 45 5 |
| $\boxed{f} \boxed{P/R}$ | | $\boxed{\div}$ | 028, 10 |
| | | $\boxed{x\div y}$ | 029, 34 |
| | | $\boxed{=}$ | 030, 36 |
| | | $\boxed{f} \boxed{P/R}$ | |

| REGISTERS | | | |
|------------------|---------------------|-------------------|----------------------------|
| n: Used. | i: Interest | PV: Used | PMT: -1. |
| FV: Residual | R_0 : # Pmts (n) | R_1 : Interest. | R_2 : Loan. |
| R_3 : Residual | R_4 : # Adv. Pmt. | R_5 : Used | R_6 - $R_{6.6}$: Unused |

1. Key in the program.
2. Key in the total number of payments then press $\boxed{STO}0$.
3. Key in or calculate the periodic interest rate then press $\boxed{STO}1$.
4. Key in the loan amount then press $\boxed{STO}2$.
5. Key in the residual value then press $\boxed{STO}3$.
6. Key in the total number of payments made in advance then press $\boxed{STO}4$.
Then press $\boxed{R/S}$ to obtain the payment amount received by the lessor.

214 Section 14: Leasing

7. For a new case, return to step 2. The values changed from the previous case are the only values which need to be re-entered.

Example 1: A copier worth \$22,000 is to be leased for 48 months. The lessee has agreed to make 4 payments in advance, with a purchase option at the end of 48 months enabling him to buy the copier for 30% of the purchase price. What monthly payment is necessary to yield the lessor 15% annually:

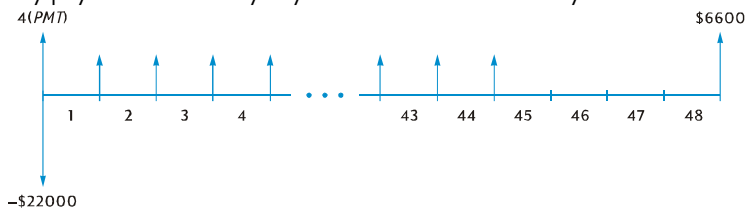

| Keystrokes (RPN mode) | Keystrokes (ALG mode) | Display | |
|-----------------------|-----------------------|-----------|-------------------------------------|
| f RPN | f ALG | | |
| 48 STO 0 | 48 STO 0 | 48.00 | Duration of lease. |
| 15 ENTER | 15 ÷ | 15.00 | |
| 12 ÷ STO 1 | 12 = STO 1 | 1.25 | Monthly interest rate. |
| 22000 STO 2 | 22000 STO 2 | 22,000.00 | |
| 30 % STO 3 | X 30 % = STO 3 | 6,600.00 | |
| 4 STO 4 R/S | 4 STO 4 R/S | 487.29 | Monthly payment received by lessor. |

Example 2: Using the information from example 1, what would the monthly payments be if the lessor desired a yield of 18% annually?

| Keystrokes (RPN mode) | Keystrokes (ALG mode) | Display | |
|-----------------------|-----------------------|---------|-------------------------------------|
| | | 487.29 | From previous example. |
| 18 ENTER 12 ÷ | 18 ÷ 12 = | 1.50 | Monthly interest rate. |
| STO 1 R/S | STO 1 R/S | 520.81 | Monthly payment received by lessor. |

Solving for Yield

Solving for yield is essentially the same as solving for Internal Rate of Return (*IRR*). The keystrokes are as follows:

1. Press \boxed{f} \boxed{CLEAR} \boxed{REG} .
2. Key in the amount of the first cash flow then press \boxed{g} $\boxed{CF_0}$. This initial amount is the difference between the initial loan amount and any payments received at closing time. Observe the sign convention: positive for cash received and negative for cash paid out.
3. Key in the amount of the first cash flow then press \boxed{g} $\boxed{CF_1}$. Then key in the number of times that cash flow occurs then press \boxed{g} $\boxed{N_1}$.
4. Key in 0 \boxed{g} $\boxed{CF_1}$ then the number of advance payments minus one. Then press \boxed{g} $\boxed{N_1}$.
5. Key in the residual then press \boxed{g} $\boxed{CF_1}$. Then press \boxed{f} \boxed{IRR} to solve for periodic yield.

Example: Equipment worth \$5,000 is leased for 36 months at \$145 per month. The lessee has agreed to pay the first and last month's payments in advance. At the end of the lease, the equipment may be purchased for \$1,500. What is the annual yield to the lessor if the equipment is purchased?

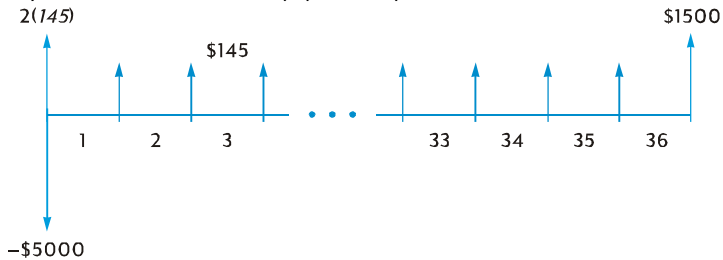

| Keystrokes (RPN mode) | Keystrokes (ALG mode) | Display | |
|--|--|-----------|-------------------------------------|
| \boxed{f} \boxed{RPN} | \boxed{f} \boxed{ALG} | | |
| \boxed{f} \boxed{CLEAR} \boxed{REG} | \boxed{f} \boxed{CLEAR} \boxed{REG} | | |
| 5000 \boxed{CHS} \boxed{ENTER} 145 \boxed{ENTER} 2 $\boxed{\times}$ $\boxed{+}$ \boxed{g} $\boxed{CF_0}$ | 145 $\boxed{\times}$ 2 $\boxed{+}$ 5000 \boxed{CHS} \boxed{g} $\boxed{CF_0}$ | -4,710.00 | Net amount of cash advanced. |
| 145 \boxed{g} $\boxed{CF_1}$ 34 \boxed{g} $\boxed{N_1}$ | 145 \boxed{g} $\boxed{CF_1}$ 34 \boxed{g} $\boxed{N_1}$ | 34.00 | Thirty-four cash flows of \$145.00. |
| 0 \boxed{g} $\boxed{CF_1}$ | 0 \boxed{g} $\boxed{CF_1}$ | 0.00 | Thirty-fifth cash flow. |
| 1500 \boxed{g} $\boxed{CF_1}$ | 1500 \boxed{g} $\boxed{CF_1}$ | 1,500.00 | Thirty-sixth cash flow. |

216 Section 14: Leasing

| Keystrokes (RPN mode) | Keystrokes (ALG mode) | Display | |
|----------------------------------|----------------------------------|----------------|-------------------------|
| f IRR 12 X | f IRR X 12 = | 18 . 10 | Annual yield to lessor. |

Section 15

Savings

Nominal Rate Converted to Effective Rate

Given a nominal interest rate and the number of compounding periods per year, this keystroke procedure computes the effective annual interest rate.

1. Press \boxed{g} \boxed{END} and \boxed{f} \boxed{CLEAR} \boxed{FIN} .

RPN Mode:

2. Key in the annual nominal rate as a percentage, then press \boxed{ENTER} .
3. Key in the number of compounding periods per year, then press \boxed{n} $\boxed{\div}$ \boxed{i} .
4. Press \boxed{CHS} \boxed{PMT} \boxed{FV} to obtain the effective annual interest rate.

ALG Mode:

2. Key in the annual nominal rate as a percentage.
3. Press $\boxed{\div}$. Key in the number of compounding periods per year, then press \boxed{i} \boxed{CHS} \boxed{PMT} . Then key in the number of compounding periods per year and press \boxed{n} .
4. Press \boxed{FV} to obtain the effective annual interest rate.

Example 1: What is the effective annual interest rate if the annual nominal rate of 5.25% is compounded quarterly?

| Keystrokes (RPN mode) | Keystrokes (ALG mode) | Display | |
|---|--|---------|----------------------------------|
| \boxed{f} \boxed{RPN} | \boxed{f} \boxed{ALG} | | |
| \boxed{g} \boxed{END} | \boxed{g} \boxed{END} | | |
| \boxed{f} \boxed{CLEAR} \boxed{FIN} | \boxed{f} \boxed{CLEAR} \boxed{FIN} | | |
| 5.25 \boxed{ENTER} | 5.25 $\boxed{\div}$ | 5.25 | Nominal rate. |
| 4 \boxed{n} $\boxed{\div}$ \boxed{i} | 4 \boxed{i} | 1.31 | Percent quarterly interest rate. |
| \boxed{CHS} \boxed{PMT} \boxed{FV} | \boxed{CHS} \boxed{PMT} 4 \boxed{n} \boxed{FV} | 5.35 | Percent effective interest rate. |

218 Section 15: Savings

For repeated calculations, the following hp 12c platinum program can be used:

| KEYSTROKES (RPN mode) | DISPLAY | KEYSTROKES (ALG mode) | DISPLAY |
|--|---------------------|--|---------------------|
| \boxed{f} $\boxed{P/R}$ | | \boxed{f} $\boxed{P/R}$ | |
| \boxed{f} \boxed{CLEAR} \boxed{PRGM} | 000 , | \boxed{f} \boxed{CLEAR} \boxed{PRGM} | 000 , |
| \boxed{g} \boxed{END} | 001 , 43 8 | \boxed{g} \boxed{END} | 001 , 43 8 |
| \boxed{f} \boxed{CLEAR} \boxed{FIN} | 002 , 42 34 | \boxed{f} \boxed{CLEAR} \boxed{FIN} | 002 , 42 34 |
| \boxed{n} | 003 , 11 | \boxed{n} | 003 , 11 |
| $\boxed{\div}$ | 004 , 10 | $\boxed{x\div y}$ | 004 , 34 |
| \boxed{i} | 005 , 12 | $\boxed{\div}$ | 005 , 10 |
| \boxed{CHS} | 006 , 16 | $\boxed{x\div y}$ | 006 , 34 |
| \boxed{PMT} | 007 , 14 | \boxed{i} | 007 , 12 |
| \boxed{FV} | 008 , 15 | \boxed{CHS} | 008 , 16 |
| \boxed{f} $\boxed{P/R}$ | | \boxed{PMT} | 009 , 14 |
| | | \boxed{FV} | 010 , 15 |
| | | \boxed{f} $\boxed{P/R}$ | |

| REGISTERS | | | |
|---------------|------------------------|-------|------------|
| n: # Periods. | i: Nom. Rate/n | PV: 0 | PMT: Used. |
| FV: Eff. Rate | R_0 - R_9 : Unused | | |

1. Key in the program.

2. **RPN:** Key in the annual nominal rate as a percentage then press $\boxed{\text{ENTER}}$.

2. **ALG:** Key in the annual nominal rate as a percentage then press $\boxed{=}$.

3. Key in the number of compounding periods per year then press $\boxed{\text{R/S}}$ to obtain the effective annual interest rate.

4. For a new case return to step 2.

Example 2: What is the effective annual rate of interest if the annual nominal rate of 5.25% is compounded monthly?

| Keystrokes (RPN mode) | Keystrokes (ALG mode) | Display | |
|-----------------------------|-------------------------|---------|----------------------------------|
| 5.25 $\boxed{\text{ENTER}}$ | 5.25 $\boxed{=}$ | 5.25 | |
| 12 $\boxed{\text{R/S}}$ | 12 $\boxed{\text{R/S}}$ | 5.38 | Percent effective interest rate. |

Effective Rate Converted to Nominal Rate

Given an effective interest rate and the number of compounding periods per year, this routine calculates the nominal interest rate.

1. Press $\boxed{\text{f}}$ $\boxed{\text{CLEAR}}$ $\boxed{\text{FIN}}$.

2. Key in the number of periods per year then press $\boxed{\text{n}}$.

3. Key in 100 then press $\boxed{\text{PV}}$.

RPN Mode:

4. Key in the effective annual rate as a percentage then press $\boxed{+}$ $\boxed{\text{CHS}}$ $\boxed{\text{FV}}$ $\boxed{\text{i}}$.

5. Press $\boxed{\text{RCL}}$ $\boxed{\text{n}}$ $\boxed{\text{X}}$ to obtain the annual nominal rate.

ALG Mode:

4. Press $\boxed{+}$. Key in the effective annual rate as a percentage then press $\boxed{=}$ $\boxed{\text{CHS}}$ $\boxed{\text{FV}}$ $\boxed{\text{i}}$.

5. Press $\boxed{\text{X}}$ $\boxed{\text{RCL}}$ $\boxed{\text{n}}$ $\boxed{=}$ to obtain the annual nominal rate.

220 Section 15: Savings

Example: Find the nominal rate compounded quarterly if the effective annual rate is 5.35%.

| Keystrokes (RPN mode) | Keystrokes (ALG mode) | Display | |
|--------------------------|--------------------------|---------|--------------------------------|
| f RPN | f ALG | | |
| f CLEAR FIN | f CLEAR FIN | | |
| 4 n 100 PV | 4 n 100 PV | 100.00 | |
| 5.35 + CHS | + 5.35 = CHS | -105.35 | |
| FV i | FV i | 1.31 | |
| RCL n X | X RCL n = | 5.25 | Percent nominal interest rate. |

Continuous Rate Converted to Effective Rate

This procedure converts a continuous annual interest rate to the effective rate.

1. **RPN:** Press 1 ENTER.

1. **ALG:** Press 1 =.

2. Key in the continuous rate as a percentage then press [%].

3. Press [g] [e^x] [%].

Example: What is the effective rate resulting from a 5.25% passbook rate with continuous compounding?

| Keystrokes (RPN mode) | Keystrokes (ALG mode) | Display | |
|--------------------------|--------------------------|---------|-----------------|
| f RPN | f ALG | | |
| 1 ENTER 5.25 [%] | 1 = 5.25 [%] | 0.05 | |
| g e ^x | g e ^x | 1.05 | |
| [%] | [%] | 5.39 | Effective rate. |

Section 16

Bonds

30/360 Day Basis Bonds

A bond is a contract to pay interest, usually semiannually, at a given rate (coupon) and to pay the principal of the bond at some specified future date. A bond which is calculated on a 30/360 day basis is one in which the day count basis is computed using 30 days in a month and 360 days in a year.

The following program solves for the price given the yield or for the yield given the price of a semiannual coupon bond which is calculated on a 30/360 day basis and is held for more than six months.

| KEYSTROKES (RPN mode) | DISPLAY | KEYSTROKES (ALG mode) | DISPLAY |
|--|-------------|--|-------------|
| \boxed{f} $\boxed{P/R}$ | | \boxed{f} $\boxed{P/R}$ | |
| \boxed{f} \boxed{CLEAR} \boxed{PRGM} | 000 , | \boxed{f} \boxed{CLEAR} \boxed{PRGM} | 000 , |
| \boxed{f} \boxed{CLEAR} \boxed{FIN} | 001 , 42 34 | \boxed{f} \boxed{CLEAR} \boxed{FIN} | 001 , 42 34 |
| \boxed{g} \boxed{BEG} | 002 , 43 7 | \boxed{g} \boxed{BEG} | 002 , 43 7 |
| \boxed{RCL} $\boxed{2}$ | 003 , 45 2 | \boxed{RCL} $\boxed{2}$ | 003 , 45 2 |
| 2 | 004 , 2 | $\boxed{\div}$ | 004 , 10 |
| $\boxed{\div}$ | 005 , 10 | 2 | 005 , 2 |
| \boxed{PMT} | 006 , 14 | \boxed{PMT} | 006 , 14 |
| \boxed{RCL} $\boxed{5}$ | 007 , 45 5 | $\boxed{+}$ | 007 , 40 |
| $\boxed{+}$ | 008 , 40 | \boxed{RCL} $\boxed{5}$ | 008 , 45 5 |
| \boxed{FV} | 009 , 15 | \boxed{FV} | 009 , 15 |
| \boxed{RCL} $\boxed{3}$ | 010 , 45 3 | \boxed{RCL} $\boxed{3}$ | 010 , 45 3 |
| \boxed{RCL} $\boxed{4}$ | 011 , 45 4 | \boxed{RCL} $\boxed{4}$ | 011 , 45 4 |
| \boxed{g} $\boxed{\Delta DYS}$ | 012 , 43 26 | \boxed{g} $\boxed{\Delta DYS}$ | 012 , 43 26 |
| \boxed{R} $\boxed{\downarrow}$ | 013 , 33 | \boxed{R} $\boxed{\downarrow}$ | 013 , 33 |

| KEYSTROKES (RPN mode) | DISPLAY | KEYSTROKES (ALG mode) | DISPLAY |
|-----------------------------------|------------------|-----------------------------------|------------------|
| 1 | 014, 1 | \div | 014, 10 |
| 8 | 015, 8 | 1 | 015, 1 |
| 0 | 016, 0 | 8 | 016, 8 |
| \div | 017, 10 | 0 | 017, 0 |
| \bar{n} | 018, 11 | \bar{n} | 018, 11 |
| $\frac{\square}{\square}$ FRAC | 019, 43 24 | $\frac{\square}{\square}$ FRAC | 019, 43 24 |
| 1 | 020, 1 | 1 | 020, 1 |
| $\times \div y$ | 021, 34 | $-$ | 021, 30 |
| $-$ | 022, 30 | $\times \div y$ | 022, 34 |
| RCL PMT | 023, 45 14 | \times | 023, 20 |
| \times | 024, 20 | RCL PMT | 024, 45 14 |
| STO 6 | 025, 44 6 | $=$ | 025, 36 |
| RCL 0 | 026, 45 0 | STO 6 | 026, 44 6 |
| $\frac{\square}{\square} x=0$ | 027, 43 35 | RCL 0 | 027, 45 0 |
| $\frac{\square}{\square}$ GTO 039 | 028, 43, 33, 039 | $\frac{\square}{\square} x=0$ | 028, 43 35 |
| 2 | 029, 2 | $\frac{\square}{\square}$ GTO 041 | 029, 43, 33, 041 |
| \div | 030, 10 | \div | 030, 10 |
| i | 031, 12 | 2 | 031, 2 |
| PV | 032, 13 | i | 032, 12 |
| RCL 6 | 033, 45 6 | PV | 033, 13 |
| $\times \div y$ | 034, 34 | RCL 6 | 034, 45 6 |
| CHS | 035, 16 | $\times \div y$ | 035, 34 |
| RCL 6 | 036, 45 6 | CHS | 036, 16 |
| $-$ | 037, 30 | $-$ | 037, 30 |
| $\frac{\square}{\square}$ GTO 000 | 038, 43, 33, 000 | RCL 6 | 038, 45 6 |

| KEYSTROKES (RPN mode) | DISPLAY | KEYSTROKES (ALG mode) | DISPLAY |
|--------------------------|-----------|-----------------------------|---------------|
| $\boxed{RCL} 1$ | 039, 45 1 | $\boxed{=}$ | 039, 36 |
| $\boxed{RCL} 6$ | 040, 45 6 | $\boxed{g} \boxed{GTO} 000$ | 040,43,33,000 |
| $\boxed{+}$ | 041, 40 | $\boxed{RCL} 1$ | 041, 45 1 |
| \boxed{CHS} | 042, 16 | \boxed{CHS} | 042, 16 |
| \boxed{PV} | 043, 13 | $\boxed{-}$ | 043, 30 |
| \boxed{i} | 044, 12 | $\boxed{RCL} 6$ | 044, 45 6 |
| 2 | 045, 2 | \boxed{PV} | 045, 13 |
| \boxed{X} | 046, 20 | \boxed{i} | 046, 12 |
| $\boxed{f} \boxed{P/R}$ | | \boxed{X} | 047, 20 |
| | | 2 | 048, 2 |
| | | $\boxed{=}$ | 049, 36 |
| | | $\boxed{f} \boxed{P/R}$ | |

| REGISTERS | | | |
|---|-----------------------------------|-----------------------------|-------------------------------|
| n: Δ days/180 | i: Yield/2 | PV: -Price | PMT: Coupon/2. |
| FV: Red+Cpn./2 | R ₀ : Yield | R ₁ : Price. | R ₂ : Coupon |
| R ₃ : D _{set} | R ₄ : D _{mat} | R ₅ : Redemption | R ₆ : Accrued Int. |
| R ₇ -R ₃ : Unused | | | |

1. Key in the program.
2. If the **C** status indicator is not displayed, press $\boxed{STO} \boxed{EEX}$.
3. Key in the annual coupon interest rate as a percentage then press $\boxed{STO} 2$.
4. Key in the settlement date (MM.DDYYYY)* then press $\boxed{STO} 3$.
5. Key in the maturity date (MM.DDYYYY)* then press $\boxed{STO} 4$.
6. Key in the redemption value as a percentage of par then press $\boxed{STO} 5$.

* For information about date format see pages 37 to 38.

224 Section 16: Bonds

7. If price is desired:
 - a. Key in the desired yield to maturity as a percentage then press $\boxed{\text{STO}}\boxed{0}$.
 - b. Press $\boxed{\text{R/S}}$ to calculate price as a percentage of par value.

- c. **RPN:** Press $\boxed{\times\div y}$ to display accrued interest due the seller. Press $\boxed{+}$ to calculate the total price paid.
- c. **ALG:** Press $\boxed{+}\boxed{\times\div y}$ to display accrued interest due the seller and then press $\boxed{=}$ to calculate the total price paid.

For a new case return to step 3. Note that only those values which have been changed need to be reentered and stored.

8. If yield is desired:
 - a. Press $\boxed{0}\boxed{\text{STO}}\boxed{0}$.
 - b. Key in the price as a percentage of par value and press $\boxed{\text{STO}}\boxed{1}$.
 - c. Press $\boxed{\text{R/S}}$ to compute annual yield to maturity.

For a new case return to step 3. Note that only those values which have been changed need to be reentered and stored.

Example 1: What price should you pay on August 28, 2004 for a 5.5% bond (computed with a 30/360 basis) that matures on June 1, 2008, if you want a yield of 4.75%? What price should you pay for a yield of 4.5%? This problem assumes a redemption value of 100.

| Keystrokes (RPN mode) | Keystrokes (ALG mode) | Display | |
|--|--|----------|---|
| $\boxed{\text{f}}\boxed{\text{RPN}}$ | $\boxed{\text{f}}\boxed{\text{ALG}}$ | | |
| $\boxed{\text{STO}}\boxed{\text{EEX}}$ | $\boxed{\text{STO}}\boxed{\text{EEX}}$ | | Set compound interest mode if the C indicator is not on. |
| $5.5\boxed{\text{STO}}\boxed{2}$ | $5.5\boxed{\text{STO}}\boxed{2}$ | 5 . 50 | Coupon into R_2 . |
| $8.282004\boxed{\text{STO}}\boxed{3}$ | $8.282004\boxed{\text{STO}}\boxed{3}$ | 8 . 28 | Settlement date into register R_3 . |
| $6.012008\boxed{\text{STO}}\boxed{4}$ | $6.012008\boxed{\text{STO}}\boxed{4}$ | 6 . 01 | Maturity date into R_4 . |
| $100\boxed{\text{STO}}\boxed{5}$ | $100\boxed{\text{STO}}\boxed{5}$ | 100 . 00 | Redemption value into R_5 . |
| $4.75\boxed{\text{STO}}\boxed{0}$ | $4.75\boxed{\text{STO}}\boxed{0}$ | 4 . 75 | Yield into R_0 . |
| $\boxed{\text{R/S}}$ | $\boxed{\text{R/S}}$ | 102 . 55 | Price (calculated). |
| $\boxed{\times\div y}$ | $\boxed{\times\div y}$ | 1 . 33 | Accrued interest (calculated). |
| $4.5\boxed{\text{STO}}\boxed{0}$ | $4.5\boxed{\text{STO}}\boxed{0}$ | 4 . 50 | New yield into R_0 . |

| Keystrokes (RPN mode) | Keystrokes (ALG mode) | Display | |
|---|---|---------|--------------------------------------|
| <code>R/S</code> | <code>R/S</code> | 103.41 | Price to yield 4.5% (calculated). |
| <code>X\leftrightarrowY</code> | <code>+ X\leftrightarrowY</code> | 1.33 | Accrued interest (calculated). |
| <code>+</code> | <code>=</code> | 104.74 | Total price paid. |

Example 2: The market is quoting 105% for the bond described in example 1. What yield will that provide? What would be the yield to maturity if 104% were the quoted price?

| Keystrokes (RPN mode) | Keystrokes (ALG mode) | Display | |
|---|---|---------|--------------------------------|
| | | 104.74 | From previous example. |
| <code>0<code>STO</code>0</code> | <code>0<code>STO</code>0</code> | 0.00 | |
| <code>105<code>STO</code>1<code>R/S</code></code> | <code>105<code>STO</code>1<code>R/S</code></code> | 4.05 | Yield at 105% (calculated). |
| <code>104<code>STO</code>1<code>R/S</code></code> | <code>104<code>STO</code>1<code>R/S</code></code> | 4.33 | Yield at 104% (calculated). |

Annual Coupon Bonds

For bonds which have annual coupons, use the following hp 12c platinum program to evaluate price and accrued interest on an Actual/Actual day basis. This program may be modified for annual coupon bonds to be calculated on a 30/360 day basis.

| KEYSTROKES (RPN mode) | DISPLAY | KEYSTROKES (ALG mode) | DISPLAY |
|--------------------------|-------------|--------------------------|-------------|
| f P/R | | f P/R | |
| f CLEAR _{PRGM} | 000 , | f CLEAR _{PRGM} | 000 , |
| f CLEAR _{FIN} | 001 , 42 34 | f CLEAR _{FIN} | 001 , 42 34 |
| g END | 002 , 43 8 | g END | 002 , 43 8 |
| RCL 0 | 003 , 45 0 | RCL 0 | 003 , 45 0 |
| n | 004 , 11 | n | 004 , 11 |
| RCL 2 | 005 , 45 2 | RCL 2 | 005 , 45 2 |
| PMT | 006 , 14 | PMT | 006 , 14 |
| RCL 1 | 007 , 45 1 | RCL 1 | 007 , 45 1 |
| i | 008 , 12 | i | 008 , 12 |
| RCL 3 | 009 , 45 3 | RCL 3 | 009 , 45 3 |
| FV | 010 , 15 | FV | 010 , 15 |
| PV | 011 , 13 | PV | 011 , 13 |
| RCL 5 | 012 , 45 5 | RCL 5 | 012 , 45 5 |
| EEX | 013 , 26 | - | 013 , 30 |
| 6 | 014 , 6 | EEX | 014 , 26 |
| CHS | 015 , 16 | 6 | 015 , 6 |
| - | 016 , 30 | CHS | 016 , 16 |
| STO 6 | 017 , 44 6 | = | 017 , 36 |
| RCL 5 | 018 , 45 5 | STO 6 | 018 , 44 6 |

| KEYSTROKES (RPN mode) | DISPLAY | KEYSTROKES (ALG mode) | DISPLAY |
|---------------------------|------------|---------------------------|------------|
| \boxed{g} Δ DYS | 019, 43 26 | \boxed{RCL} 5 | 019, 45 5 |
| \boxed{STO} 7 | 020, 44 7 | \boxed{g} Δ DYS | 020, 43 26 |
| \boxed{RCL} 6 | 021, 45 6 | \boxed{STO} 7 | 021, 44 7 |
| \boxed{RCL} 4 | 022, 45 4 | \boxed{RCL} 6 | 022, 45 6 |
| \boxed{g} Δ DYS | 023, 43 26 | \boxed{RCL} 4 | 023, 45 4 |
| \boxed{RCL} 7 | 024, 45 7 | \boxed{g} Δ DYS | 024, 43 26 |
| $\boxed{\div}$ | 025, 10 | $\boxed{\div}$ | 025, 10 |
| \boxed{n} | 026, 11 | \boxed{RCL} 7 | 026, 45 7 |
| 0 | 027, 0 | \boxed{n} | 027, 11 |
| \boxed{PMT} | 028, 14 | 0 | 028, 0 |
| \boxed{FV} | 029, 15 | \boxed{PMT} | 029, 14 |
| \boxed{CHS} | 030, 16 | \boxed{FV} | 030, 15 |
| \boxed{RCL} \boxed{n} | 031, 45 11 | \boxed{RCL} \boxed{n} | 031, 45 11 |
| \boxed{RCL} 2 | 032, 45 2 | \boxed{X} | 032, 20 |
| \boxed{CHS} | 033, 16 | \boxed{RCL} 2 | 033, 45 2 |
| \boxed{X} | 034, 20 | \boxed{CHS} | 034, 16 |
| $\boxed{R/S}$ | 035, 31 | $\boxed{+}$ | 035, 40 |
| $\boxed{-}$ | 036, 30 | $\boxed{R/S}$ | 036, 31 |
| \boxed{f} $\boxed{P/R}$ | | $\boxed{X \div Y}$ | 037, 34 |
| | | $\boxed{=}$ | 038, 36 |
| | | \boxed{CHS} | 039, 16 |
| | | \boxed{f} $\boxed{P/R}$ | |

| REGISTERS | | | |
|-----------------------------|---|----------------------------|------------------------------|
| n: Used | i: Yield | PV: Used | PMT: Cpn. or 0 |
| FV: Used | R ₀ : # Periods (n) | R ₁ : Yield | R ₂ : Coupon |
| R ₃ : Redemption | R ₄ : Settlement | R ₅ : Next Cpn. | R ₆ : Last Coupon |
| R ₇ : Used | R ₈ -R ₅ : Unused | | |

For annual coupon bonds calculated on a 30/360 day basis, insert \boxed{RI} after $\boxed{9} \boxed{ADYS}$ at steps 19 and 23 in the RPN mode program and after $\boxed{9} \boxed{ADYS}$ at steps 20 and 24 in the ALG mode (making each program two steps longer).

1. Key in the program and press $\boxed{STO} \boxed{EEX}$ if the **C** status indicator is not displayed.
2. Key in the total number of coupons which are received and press $\boxed{STO} \boxed{0}$.
3. Key in the annual yield as a percentage then press $\boxed{STO} \boxed{1}$.
4. Key in the amount of the annual coupon then press $\boxed{STO} \boxed{2} *$
5. Key in the redemption value then press $\boxed{STO} \boxed{3} *$
6. Key in the settlement (purchase) date† then press $\boxed{STO} \boxed{4}$.
7. Key in the date of the next coupon then press $\boxed{STO} \boxed{5}$.
8. Press $\boxed{R/S}$ to obtain the amount of accrued interest.
9. Press $\boxed{R/S}$ to determine the price of the bond.
10. For a new case, return to step 2.

Example: What is the price and accrued interest of a 20-year Eurobond with annual coupons of 6.5% purchased on August 15, 2004 to yield 7%. The next coupon is received on December 1, 2004.

| Keystrokes (RPN mode) | Keystrokes (ALG mode) | Display | |
|-----------------------------|-----------------------------|---------|---|
| $\boxed{f} \boxed{RPN}$ | $\boxed{f} \boxed{ALG}$ | | |
| $\boxed{STO} \boxed{EEX}$ | $\boxed{STO} \boxed{EEX}$ | | Set compound interest mode if the C indicator is not on. |
| $20 \boxed{STO} \boxed{0}$ | $20 \boxed{STO} \boxed{0}$ | 20.00 | Total number of coupons. |
| $7 \boxed{STO} \boxed{1}$ | $7 \boxed{STO} \boxed{1}$ | 7.00 | Annual yield. |
| $6.5 \boxed{STO} \boxed{2}$ | $6.5 \boxed{STO} \boxed{2}$ | 6.50 | Annual coupon rate. |

* Positive for cash received; negative for cash paid out.

† For information about date format see page 37.

| Keystrokes (RPN mode) | Keystrokes (ALG mode) | Display | |
|-------------------------------------|-------------------------------------|----------------|-------------------|
| 100 $\overline{\text{STO}}$ 3 | 100 $\overline{\text{STO}}$ 3 | 100 . 00 | Redemption value. |
| 8.152004 $\overline{\text{STO}}$ 4 | 8.152004 $\overline{\text{STO}}$ 4 | 8 . 15 | Settlement date. |
| 12.012004 $\overline{\text{STO}}$ 5 | 12.012004 $\overline{\text{STO}}$ 5 | 12 . 01 | Next coupon date. |
| $\overline{\text{R/S}}$ | $\overline{\text{R/S}}$ | -4 . 58 | Accrued interest. |
| $\overline{\text{R/S}}$ | $\overline{\text{R/S}}$ | -94 . 75 | Purchase price. |

Appendices

Appendix A

RPN and the Stack

In RPN mode, four special registers in the hp 12c platinum are used for storing numbers during calculations. To understand how these registers are used, they should be visualized as stacked on top of each other.

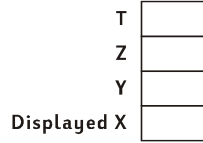

(For this reason, they are generally referred to as the “stack registers” or collectively as “the stack.”) The stack registers are designated X, Y, Z, and T. Unless the calculator is in Program mode, the number shown in the display is the number in the X-register (modified according to the current display format).

The number in the X-register — and, for two-number functions, the number in the Y-register — are the number(s) used in calculations. The Z- and T-registers are used primarily for the automatic retention of intermediate results during chain calculations, as described in section 1.

Before we discuss the details of the stack operation, let’s take a quick look at how the stack is used in a simple arithmetic calculation and in a chain calculation. For each key pressed in the keystroke sequence, the diagram illustrating the calculation shows, above the key, the numbers in each of the stack registers after that key is pressed.

First, let’s consider the calculation of $5 - 2$:

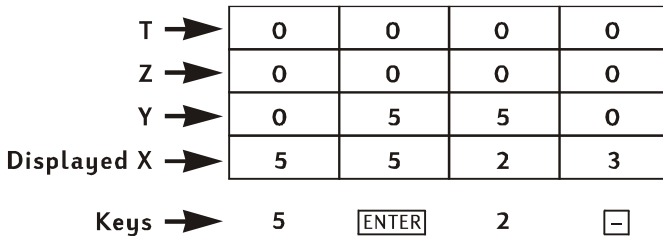

The diagram shows why we said in section 1 that the **ENTER** key *separates* the second number entered from the first number entered. Note also that this positions the 5 in the Y-register above the 2 in the X-register — just like they would be positioned if you wrote the calculation vertically on paper:

$$\begin{array}{r}
 5 \\
 -2 \\
 \hline
 \end{array}$$

Now let's see what happens in the stack during a chain calculation in RPN mode:

$$\frac{(3 \times 4) + (5 \times 6)}{7}$$

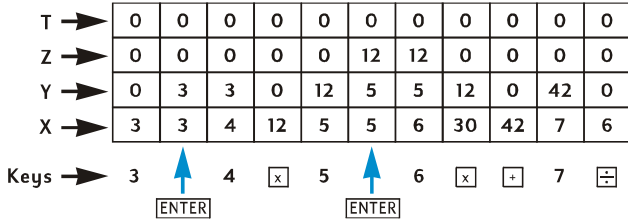

See how the intermediate results are not only displayed when they are calculated, but also automatically stored and available in the stack at just the right time!

That's basically how the stack operates. In the rest of this appendix, we'll take a more detailed look at how numbers are entered into and rearranged within the stack, and the effect of the various hp 12c platinum functions on the numbers in the stack.

Getting Numbers Into the Stack: The ENTER Key

As discussed in earlier sections, if two numbers are being keyed in for a two-number function — such as \div — you press ENTER between the numbers to separate them. The following diagram illustrates what happens in the stack when you enter the numbers 10 and 3 (to calculate, for example, $10 \div 3$). (Assume that the stack registers have been already loaded with the numbers shown as the result of previous calculations).

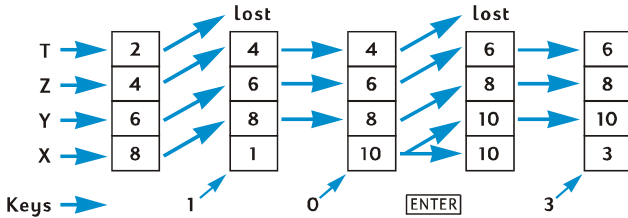

When a digit is keyed into the display, it is simultaneously entered into the X-register. As additional digit keys are pressed, the corresponding digits are appended (that is, added to the right of) those already in the displayed X-register until ENTER is pressed. As shown in the preceding diagram, pressing ENTER does the following:

1. It copies the number from the displayed X-register into the Y-register. This process is part of the *stack lift*.

- It tells the calculator that the number in the displayed X-register is complete: that is, it *terminates digit entry*.

Termination of Digit Entry

The first digit keyed in after digit entry has been terminated *replaces* the number already in the displayed X-register. Digit entry is automatically terminated when any key is pressed (except for digit entry keys — digit keys, \square , $\boxed{\text{CHS}}$, and $\boxed{\text{EEEX}}$ — and prefix keys — $\boxed{\text{f}}$, $\boxed{\text{g}}$, $\boxed{\text{STO}}$, $\boxed{\text{RCL}}$, and $\boxed{\text{GTO}}$).

Stack Lift

When the stack lifts, the number in each stack register is copied into the register above, and the number formerly in the T-register is lost. The number formerly in the X-register is then contained in both the X-register and the Y-register.

When a number is entered into the displayed X-register — either from the keyboard, from a storage register (using $\boxed{\text{RCL}}$), or from the LAST X register (using $\boxed{\text{LSTX}}$) — the stack *usually* lifts first. The stack does *not* lift if the last key pressed before a number is entered was one of the following: $\boxed{\text{ENTER}}$ *, $\boxed{\text{CLX}}$, $\boxed{\Sigma+}$ or $\boxed{\Sigma-}$. If one of these keys was the last key pressed, the number in the displayed X-register is replaced when a new number is entered.

Rearranging Numbers in the Stack

The $\boxed{\text{X}\leftrightarrow\text{Y}}$ Key

Pressing $\boxed{\text{X}\leftrightarrow\text{Y}}$ exchanges the numbers in the X- and Y-registers.

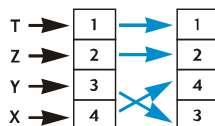

Certain functions ($\boxed{\Delta\text{DYS}}$, $\boxed{\text{INT}}$, $\boxed{\text{AMORT}}$, $\boxed{\text{PRICE}}$, $\boxed{\text{SL}}$, $\boxed{\text{SOYD}}$, $\boxed{\text{DB}}$, $\boxed{\bar{\text{X}}}$, $\boxed{\text{S}}$, $\boxed{\hat{\text{Y}}.r}$, and $\boxed{\hat{\text{X}}.r}$) return answers to the Y-register as well as to the displayed X-register. The $\boxed{\text{X}\leftrightarrow\text{Y}}$ key, since it exchanges the number in the Y-register with that in the displayed X-register, is used to display the second number calculated.

* Note also that although the stack lifts when $\boxed{\text{ENTER}}$ is pressed, it does not lift *when a number is entered after $\boxed{\text{ENTER}}$ is pressed*.

The $\boxed{R\downarrow}$ Key

When $\boxed{R\downarrow}$ (roll down) is pressed the number in each stack register is copied into the register below, and the number formerly in the X-register is copied into the T-register.

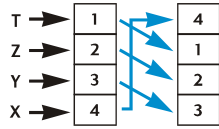

Pressing $\boxed{R\downarrow}$ four times successively displays the numbers in the Y-, Z-, and T-registers and returns the numbers to their original registers.

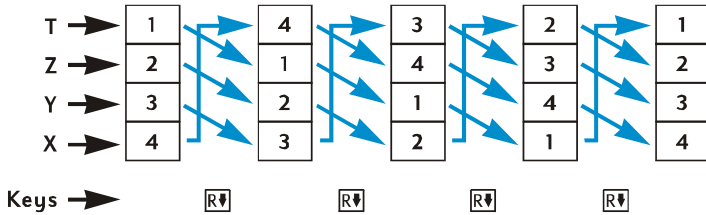

One-Number Functions and the Stack

One-number mathematics and number-alteration functions — $\boxed{1/x}$, $\boxed{\sqrt{x}}$, \boxed{LN} , $\boxed{e^x}$, $\boxed{x^2}$, $\boxed{n!}$, \boxed{RND} , \boxed{INTG} , and \boxed{FRAC} — use only the number in the displayed X-register. When the key is pressed, the function is performed upon the number in the X-register, and the answer is then placed into the X-register. The stack does not lift, so the number formerly in the X-register does not get copied into the Y-register; but this number is copied into the LAST X register. The numbers in the Y-, Z-, and T-registers are not affected when a one number function is performed.

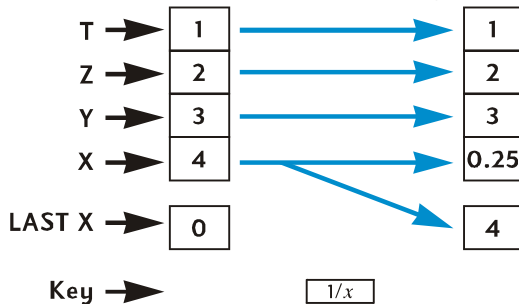

Two-Number Functions and the Stack

Two-number functions — $\boxed{+}$, $\boxed{-}$, $\boxed{\times}$, $\boxed{\div}$, $\boxed{y^x}$, $\boxed{\%}$, $\boxed{\Delta\%}$, and $\boxed{\%T}$ — use the numbers in both the X- and the Y-registers.

Mathematics Functions

To perform an arithmetic operation, the numbers are positioned in the X- and Y-registers just as you would write them vertically on paper: the number you would write on top goes in the Y-register, and the number you would write on the bottom goes in the X-register. For example, to do each of the four arithmetic calculations shown below, you would put the 8 in the Y-register (using $\boxed{\text{ENTER}}$ and then key the 2 into the displayed X-register.)

| Addition | Subtraction | Multiplication | Division |
|--|--|--|--|
| $\begin{array}{r} 8 \\ +2 \\ \hline \end{array}$ | $\begin{array}{r} 8 \\ -2 \\ \hline \end{array}$ | $\begin{array}{r} 8 \\ \times 2 \\ \hline \end{array}$ | $\begin{array}{r} 8 \\ \hline 2 \end{array}$ |

When an arithmetic operation or $\boxed{y^x}$ is performed, the answer is placed in the X-register, the number formerly in the X-register is copied into the LAST X register, and the stack *drops*. When the stack drops, the number in the Z-register is copied into the Y-register, and the number in the T-register is copied into the Z-register *but* also remains in the T-register.

The diagram on the next page illustrates the stack operation when $8 \div 2$ is calculated. (Assume that the stack and LAST X registers have already been loaded with the numbers shown as the result of previous calculations.)

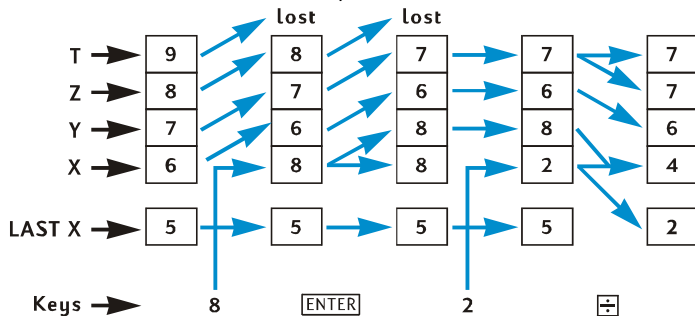

Percentage Functions

When any of the three percentage functions is performed, the answer is placed in the X-register, the number formerly in the X-register is copied into the LAST X register, but the stack does not drop. The numbers in the Y-, Z-, and T-registers are not changed when a percentage function is performed.

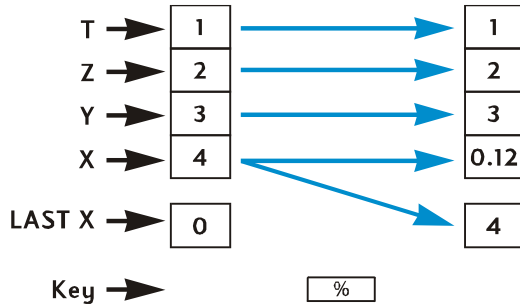

Calendar and Financial Functions

The following table shows what quantity is in each stack register after the indicated calendar or financial function key is pressed. The symbols x , y , z , and t represent the number that was in the corresponding register (X, Y, Z, or T, respectively) at the time the function key was pressed.

| Register | DATE | Δ DYS | INT | \overline{n} , \overline{i} , \overline{PV} , \overline{PMT} , \overline{FV} , \overline{NPV} , \overline{IRR} | AMORT |
|----------|------|------------------------------|-------------|--|--------------------------|
| T | t | t | x | z | y |
| Z | t | z | INT_{365} | y | x (number of payments) |
| Y | z | $\Delta DYS_{30\text{-day}}$ | $-PV$ | x | PMT_{PRIN} |
| X | DATE | ΔDYS_{actual} | INT_{360} | $n, i, PV, PMT, FV, NPV, IRR$ | PMT_{INT} |

| Register | PRICE | YTM | SL, SOYD, DB |
|----------|---------------------|---------------------|-----------------------------------|
| T | y (settlement date) | z | y |
| Z | x (maturity date) | y (settlement date) | x (number of year) |
| Y | INT | x (maturity date) | RDV (remaining depreciable value) |
| X | PRICE | YTM | DEP |

The LAST X Register and the $\boxed{\text{LSTX}}$ Key

The number in the displayed X-register is copied into the **LAST X** register whenever any of the following function keys is pressed:

- | | | | | |
|-----------------------|-----------------------|---------------------|--------------------|-----------------------|
| $\boxed{+}$ | $\boxed{-}$ | $\boxed{\times}$ | $\boxed{\div}$ | $\boxed{\frac{1}{x}}$ |
| $\boxed{y^x}$ | $\boxed{e^x}$ | $\boxed{\text{LN}}$ | $\boxed{\sqrt{x}}$ | $\boxed{\text{RND}}$ |
| $\boxed{\text{FRAC}}$ | $\boxed{\text{INTG}}$ | $\boxed{\Sigma+}$ | $\boxed{\Sigma-}$ | $\boxed{\hat{x},r}$ |
| $\boxed{\hat{y},r}$ | $\boxed{n!}$ | $\boxed{\%}$ | $\boxed{\Delta\%}$ | $\boxed{\%T}$ |
| $\boxed{\text{DATE}}$ | $\boxed{\text{ADYS}}$ | $\boxed{x^2}$ | | |

Pressing $\boxed{\text{g}} \boxed{\text{LSTX}}$ lifts the stack (unless $\boxed{\text{ENTER}}$, $\boxed{\text{CLx}}$, $\boxed{\Sigma+}$ or $\boxed{\Sigma-}$ was the last key pressed, as described on page 234), then copies the number from the LAST X register into the displayed X-register. The number remains also in the LAST X register.

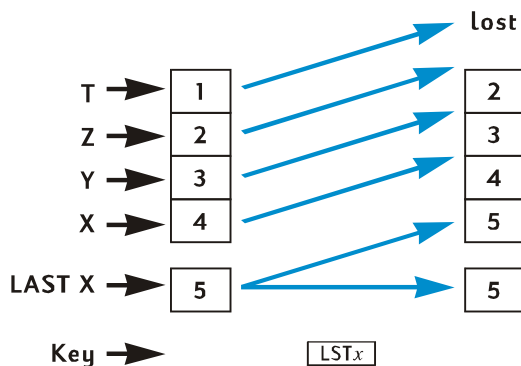

Chain Calculations in RPN Mode

The automatic stack lift and stack drop make it possible to do chain calculations without the necessity for keying in parentheses or storing intermediate results, as are required on some other calculators. An intermediate result in the displayed X-register is automatically copied into the Y-register when a number is keyed in after a function key is pressed.* Therefore, when a two-number function key is then pressed, that function is performed using the number keyed into the displayed X-register and the intermediate result in the Y-register. The number then in the Y-register, if remaining as an intermediate result from an earlier calculation, can then be used with the intermediate result in the X-register for another calculation.

The diagram on page 233 illustrates how the automatic stack lift and stack drop make chain calculations quick and error-free.

Virtually every chain calculation you are likely to encounter can be done using only the four stack registers. However, to avoid having to store an intermediate result in a storage register, you should begin every chain calculation at the innermost number or pair of parentheses and then work outward — just as you would if you were doing the calculation manually (that is, using pencil and paper). For example, consider the calculation of

$$3 [4 + 5 (6 + 7)]$$

If this calculation were done from left to right — as were the (simpler) examples under Chain Calculations on page 23 and page 25 — you would have to enter *five* numbers into the calculator before doing the first operation possible ($6 + 7$). But since the stack holds only four numbers, this calculation *cannot* be done left-to-right. However, it can easily be done if you begin with the calculation in the innermost pair of parentheses — again, ($6 + 7$).

| Keystrokes (RPN mode) | Display | |
|---------------------------|---------|--|
| 6 ENTER 7 + | 13.00 | Intermediate result of (6+7). |
| 5 X | 65.00 | Intermediate result of 5 (6+7). |
| 4 + | 69.00 | Intermediate result of [4 + 5(6 + 7)]. |
| 3 X | 207.00 | Final result: 3 [4 + 5 (6 + 7)]. |

* Except for **ENTER**, **CLx**, **Σ+**, **Σ-**. For more information, refer to Stack Lift, page 234.

Arithmetic Calculations with Constants

Because the number in the T-register remains there when the stack drops, this number can be used as a constant in arithmetic operations. To place the constant into the T-register, key it into the display (that is, into the X-register), then press **ENTER** three times. This also places the constant in the Y and Z-registers. Each time an arithmetic operation is then performed — using the constant in the Y-register and a number keyed into the displayed X-register — the constant will be “dropped” back into the Y-register.

Example: The annual sales of solar engineering hardware your firm — currently \$84,000 — are projected to double each year for the next 3 years. Calculate the annual sales for each of those years.

Keystrokes (RPN mode)

Display

| | | |
|-----------------------------|----------------|---|
| 2 ENTER ENTER | | |
| ENTER | 2 . 00 | Enters constant into Y, Z, and T-registers. |
| 84000 | 84 , 000 . | Enters base amount into displayed X-register. |
| X | 168 , 000 . 00 | Annual sales after first year. |
| X | 336 , 000 . 00 | Annual sales after second year. |
| X | 672 , 000 . 00 | Annual sales after third year. |

In the example above, the constant was repeatedly multiplied by the result of the previous operation, which was already in the displayed X-register. In another class of calculations with constants, the constant is multiplied by (or added to, etc.) a new number keyed into the displayed X-register. For these calculations, you must press **CLX** before keying in a new number after having pressed an operator key. If this were not done, the stack would lift when you keyed in a new number after pressing the operator key, and the Y-register would no longer contain the constant. (Recall — from page 234 — that the stack does not lift when a number is keyed into the displayed X-register after **CLX** is pressed.)

Example: At Permex Pipes a certain pipe fitting is packaged in quantities of 15, 75, and 250. If the cost per fitting is \$4.38, calculate the cost of each package.*

**Keystrokes
(RPN mode)**

Display

| | | |
|--|--------------|--|
| 4.38 <input type="text" value="ENTER"/> <input type="text" value="ENTER"/> | | |
| <input type="text" value="ENTER"/> | 4 . 38 | Enters constant into Y-, Z-, and T-registers. |
| 15 | 15 . | Enters first quantity into displayed X-register. |
| <input type="text" value="X"/> | 65 . 70 | Cost of a package of 15. |
| <input type="text" value="CLx"/> 75 | 75 . | Clears display and enters second quantity into displayed X-register. |
| <input type="text" value="X"/> | 328 . 50 | Cost of a package of 75. |
| <input type="text" value="CLx"/> 250 | 250 . | Clears display and enters third quantity into displayed X-register. |
| <input type="text" value="X"/> | 1 , 095 . 00 | Cost of a package of 250. |

* You may want to compare this method of arithmetic calculations with constants to the method using described on page 90.

Appendix B

Algebraic Mode (ALG)

Although most of this material is included at the appropriate places throughout this manual, it is collected here for easy reference.

To select algebraic mode, press \boxed{f} \boxed{ALG} . When the calculator is in algebraic mode, the **ALG** status indicator is lit.

Note: In ALG mode, it is a good idea to begin calculations by pressing \boxed{CLx} \boxed{CLx} . This will ensure that there are no pending arithmetic calculations that might interfere with the solution of a new problem. The reason this key is pressed twice is that pressing it the first time clears the display and X-register only, allowing you to correct an erroneous entry by keying in a correct number. The second press of \boxed{CLx} will clear any pending operations as well. Pressing the $\boxed{=}$ key is another way to ensure that there are no pending operations before beginning a new calculation.

Simple Arithmetic Calculations in ALG Mode

To calculate $21.1 + 23.8$:

| Keystrokes (ALG mode) | Display | |
|-----------------------------|---------|--|
| \boxed{CLx} \boxed{CLx} | 0 . 00 | Clears any pending operations. |
| 21.1 $\boxed{+}$ | 21 . 10 | Enters first number and prepares to add. |
| 23.8 | 23 . 8 | Enters the second number. |
| $\boxed{=}$ | 44 . 90 | $\boxed{=}$ completes the calculation. |

Once a calculation has been completed:

- pressing another digit key starts a new calculation, or
- pressing an operator key continues the calculation.

| Keystrokes (ALG mode) | Display | |
|-----------------------------|---------|---|
| \boxed{CLx} \boxed{CLx} | 0 . 00 | Clears any pending operations. |
| 77.35 $\boxed{-}$ | 77 . 35 | Enters first number and prepares to subtract. |

**Keystrokes
(ALG mode)****Display**

90.89 [=]

-13.54

[=] completes the calculation.

65 [9] [√x] [X] 12 [=]

96.75

New calculation: $\sqrt{65} \times 12$

[÷] 3.5 [=]

27.64

Calculates $96.75 \div 3.5$

You can also do long calculations without pressing [=] after each intermediate calculation: just press it at the end. The operators perform from left to right, in the order you enter them.

Keying in Negative Numbers ([CHS])

The [CHS] key changes the sign of a number.

- To key in a negative number, type that number and then press [CHS].
- To change the sign of an already displayed number, press [CHS].

**Keystrokes
(ALG mode)****Display**

[CLx] [CLx]

0.00

Clears any pending operations.

75 [CHS]

-75.

Changes the sign of 75

[X] 7.1 [=]

-532.50

Multiplies -75 by 7.1

Chain Calculations in ALG Mode

To do a chain calculation, you don't need to press [=] after each operation, but only at the very end.

For instance, to calculate $\frac{750 \times 12}{360}$ you can enter either:

- 750 [X] 12 [=] [÷] 360 [=] or
- 750 [X] 12 [÷] 360 [=]

In the second case, the [÷] key acts like the [=] key by displaying the result of 750×12 .

Here's a longer chain calculation: $\frac{456 - 75}{18.5} \times \frac{68}{1.9}$

This calculation can be written as: $456 - 75 \div 18.5 \times 68 \div 1.9$. Watch what happens in the display as you key it in:

**Keystrokes
(ALG mode)****Display**

CLx CLx

0 . 00

Clears any pending operations.

456 − 75 ÷

381 . 00

18.5 X

20 . 59

68 ÷

1 , 400 . 43

1.9 =

737 . 07

The $\boxed{9} \boxed{\text{LSTX}}$ Key in ALG Mode

LAST X in ALG mode is not used in this book. It is the one function that is quite different in ALG and RPN modes. Refer to page 238 for the list of 23 different key presses that cause the displayed X-register to be copied into the LAST X register in RPN mode. In ALG mode, those key presses do **not** cause a refresh of the LAST X register. Instead, the displayed number is copied into the LAST X register when a **new** calculation commences either with **digit entry** (i.e., when one of the digits 0-9, the decimal point, or $\boxed{\text{EEX}}$ is pressed) or with $\boxed{9} \boxed{\text{LSTX}}$ itself, but not when a number is recalled using $\boxed{\text{RCL}}$.

When $\boxed{9} \boxed{\text{LSTX}}$ is actually **executed** in ALG mode, it simply swaps the value in the X-register with the value in LAST X. Therefore, in ALG mode, it never lifts the stack and in general, it changes the value in LAST X. However, in RPN mode, $\boxed{9} \boxed{\text{LSTX}}$ always lifts the stack and leaves the value in LAST X unchanged.

In general, LAST X in ALG mode is only useful in programs, where it can often be used instead of a numbered storage register, as it persists unchanged at least until digit entry or $\boxed{9} \boxed{\text{LSTX}}$. There is an example of its use in the Combinations program in the hp 12c platinum Solutions Handbook.

The History Stack in ALG Mode

In ALG mode, the stack holds a “history” of 4 completed results. These results may be rearranged using $\boxed{\text{R}\downarrow}$ and $\boxed{\text{X}\uparrow\text{Y}}$ in the same way as described on page 234, for RPN mode.

Note that once a two-numbered function (such as $\boxed{+}$, $\boxed{-}$, $\boxed{\times}$, $\boxed{\div}$ or $\boxed{y^x}$) has had the second argument entered, the two arguments cannot then be swapped using $\boxed{\text{X}\uparrow\text{Y}}$ because when the second argument is entered it replaces the first, which is removed from the stack. So, if you wish to do $25.83 \boxed{-} 144.25$, but then realize you meant to do $144.25 \boxed{-} 25.83$, the way to correct this is to proceed and do $\boxed{=}$ $\boxed{\text{CHS}}$. All $\boxed{\text{X}\uparrow\text{Y}}$ will do at this point is replace the 144.25 with whatever was displayed before the 25.83 was entered, and the first argument remains unchanged.

The stack diagrams showing the output for the Calendar and Financial functions on page 237 are the same for ALG as RPN mode. To add INT and PRICE after executing the bond PRICE function, press $\boxed{+} \boxed{\times \div y} \boxed{=}$. In this case, $\boxed{\times \div y}$ is used to enter the second argument for the $\boxed{+}$ operation. After executing $\boxed{+} \boxed{\times \div y} \boxed{=}$, the total price (INT + PRICE) will be displayed. LAST X will be unchanged, but the original PRICE will be found in the Y-register. One can also do $\boxed{+} \boxed{R\downarrow} \boxed{=}$ to get the total price, with the only difference being that the original PRICE would then be in the T-register.

Parentheses Calculations

In ALG mode, parentheses can be used in calculations to change the order in which operations are evaluated. When there are pending open parentheses, the () status indicator will be shown in the display. As open parentheses are closed, the expression contained within the parentheses is evaluated. The final result of a calculation will be displayed when you press the $\boxed{=}$ key, and then any pending parentheses will be closed. You can't use more than 13 pending (opened) parentheses at the same time.

$$\frac{8}{(5 - 1)}$$

Keying $8 \div 5 - 1$ will calculate $8 \div 5$ first and then the result (1.6) will have 1 subtracted from it (resulting in 0.6).

Keystrokes (ALG mode)

Display

$\boxed{\text{CLx}} \boxed{\text{CLx}}$

0.00

Clears any pending operations.

$8 \boxed{\div} \boxed{9} \boxed{(} \boxed{5} \boxed{-}$

5.00

No calculation is done.

$1 \boxed{9} \boxed{)}$

4.00

Calculates $5 - 1$.

$\boxed{=}$

2.00

Calculates $\frac{8}{(5 - 1)}$.

Percentage Functions

In most cases, $\%$ divides a number by 100.

The one exception is when a plus or minus sign precedes the number.

For instance, 25 $\%$ results in 0.25.

To find 25% of 200, press: 200 \times 25 $\%$ $=$. (Result is 50.)

You can also calculate a net amount all in one calculation:

For instance, to decrease 200 by 25%, just enter 200 $-$ 25 $\%$ $=$. (Result is 150.)

Example: You borrow \$1,250 from a relative, and agree to repay the loan in a year with 7% simple interest. How much money will you owe?

Keystrokes (ALG mode)

Display

| | | |
|---------------------------|--------------|---|
| CLX CLX | 0 . 00 | Clears any pending operations. |
| 1250 $+$ 7 $\%$ | 87 . 50 | Interest on the loan is \$87.50. |
| $=$ | 1 , 337 . 50 | You owe this amount at the end of one year. |

Percent Difference

To find the percent difference between two numbers:

1. Key in the base number.
2. Press $=$ to separate the other number from the base number.
3. Key in the other number.
4. Press $\Delta\%$.

Example: Yesterday your stock fell from 35.5 to 31.25 per share. What is the percent change?

Keystrokes (ALG mode)

Display

| | | |
|---------------------------|----------|---|
| CLX CLX | 0 . 00 | Clears any pending operations. |
| 35.5 $=$ | 35 . 50 | Keys in the base number and separates it from the other number. |
| 31.25 | 31 . 25 | Keys in the other number. |
| $\Delta\%$ | -11 . 97 | Nearly a 12% decrease. |

Percent of Total

To calculate what percentage one number is of another:

1. Calculate the total amount by adding all individual amounts.
2. Key in the number whose percentage equivalent you wish to find.
3. Press $\boxed{\%T}$.

Example: Last month, your company posted sales of \$3.92 million in the U.S., \$2.36 million in Europe, and \$1.67 million in the rest of the world. What percentage of the total sales occurred in Europe?

Keystrokes (ALG mode)

Display

| | | |
|---------------------------|---------|--|
| $\boxed{CLx} \boxed{CLx}$ | 0 . 00 | Clears any pending operations. |
| 3.92 $\boxed{+}$ | 3 . 92 | Keys in the first number. |
| 2.36 $\boxed{+}$ | 6 . 28 | Adds the second number. |
| 1.67 $\boxed{=}$ | 7 . 95 | Adds the third number to get the total. |
| 2.36 | 2 . 36 | Keys in 2.36 to find out what percentage it is of the number in the display. |
| $\boxed{\%T}$ | 29 . 69 | Europe had nearly 30% of the total sales. |

The Power Function

Pressing $\boxed{y^x}$ calculates a power of a number, that is, y^x . Like the arithmetic function $\boxed{+}$, $\boxed{y^x}$ requires two numbers:

1. Key in the base number (which is designated by the y on the key).
2. Press $\boxed{y^x}$ and key in the exponent (which is designated by the x on the key)
3. Press $\boxed{=}$ to calculate the power.

Don't forget to press $\boxed{CLx} \boxed{CLx}$ if you are unsure if there are any pending operations.

To Calculate

Keystrokes (ALG mode)

Display

| | | |
|----------------------------|---|---------|
| $2^{1.4}$ | 2 $\boxed{y^x}$ 1.4 $\boxed{=}$ | 2 . 64 |
| $2^{-1.4}$ | 2 $\boxed{y^x}$ 1.4 $\boxed{CHS} \boxed{=}$ | 0 . 38 |
| $(-2)^3$ | 2 $\boxed{CHS} \boxed{y^x}$ 3 $\boxed{=}$ | -8 . 00 |
| $\sqrt[3]{2}$ or $2^{1/3}$ | 2 $\boxed{y^x}$ 3 $\boxed{1/x} \boxed{=}$ | 1 . 26 |

Appendix C

More About IRR

Given a sequence of positive and negative cash flows, we hope that there is enough information to determine whether an *IRR* answer exists, and what that answer is. For the vast majority of cases, your hp 12c platinum will find the unique *IRR* answer if it exists. But the *IRR* computation is so complex that if the cash flow sequence does not meet certain criteria, then sometimes the calculator is unable to determine whether or not an answer or answers exist.

Let's look at all of the possible outcomes of *IRR* as calculated by your hp 12c platinum:

Case 1: A positive answer. If a positive answer is displayed, it is the only such answer. One or more negative answers may also exist.

Case 2: A negative answer. If a negative answer is displayed, there *may* be additional negative answers, and there *may* be a single positive answer. If additional answers (negative or positive) exist, they can be calculated using the procedure described below.

Case 3: The calculator displays **Error 3**. This indicates that the computation is very complex, possibly involving multiple answers, and cannot be continued until you give the calculator an estimate of *IRR*. The procedure for doing so is described below.

Case 4: The calculator displays **Error 7**. This indicates that there is no answer to the computation of *IRR* with the cash flow amounts you have entered. This situation is probably the result of a mistake in entering the magnitudes or signs of the cash flows or the number of times a cash flow amount occurs consecutively. Refer to Reviewing Cash Flow Entries (page 79) and Changing Cash Flow Entries (page 80) to check and correct the entries. **Error 7** will result if there is not at least one positive cash flow *and* at least one negative cash flow.

Although the calculator will eventually reach one of the above outcomes, it may take a long time to get there. You may wish to terminate the *IRR* iterative process, by pressing any key, to see what interest rate the calculator has computed at that point. If you stop the calculation, you may continue searching for *IRR* as described below.

Searching for IRR. You can continue searching for IRR solutions, even after an **Error 3** indication, as follows:

1. Make a guess for the interest rate and key it in.
2. Press **RCL** **g** **R/S**.

Your guess will aid the calculator in its search, and if it finds an *IRR* answer near your guess, that answer will be displayed. Since the calculator cannot tell you the number of solutions that exist when there is more than one mathematically correct answer, you can continue to make guesses, pressing **RCL** **g** **R/S** after each one, to search for *IRR* solutions.

You can hasten this process by using the **NPV** function to help you make a good guess. Remember that a correct *IRR* solution will make the calculated *NPV* very small. So continue to guess interest rates and solve for *NPV* until the answer you obtain is reasonably close to zero. Then press **RCL** **g** **R/S** to calculate the *IRR* answer near your guess.

How would this work in case 2 above? The calculator displays a negative answer and you wish to check for a unique positive *IRR*. Key in successively larger guesses for *i* (starting from 0) and solve for *NPV* until you reach a sign change in your *NPV* outcomes. Then press **RCL** **g** **R/S** to find an *IRR* solution near the last interest rate obtained using the **NPV** key.

If you stop the *IRR* iterative process, you can test the interest obtained using **NPV**, and then restart the process by pressing **RCL** **g** **R/S**.

Appendix D

Error Conditions

Some calculator operations cannot be performed under certain conditions (for example, \div when $x = 0$). If you attempt such an operation under these conditions, the calculator will display the word **Error** followed by a digit, **0** through **9**. Listed below are operations that cannot be performed under the conditions specified. The symbols x and y represent the number in the X- and Y-registers, respectively, when the operation key is pressed.

Error 0: Mathematics

| Operation | Condition |
|--------------------------|--|
| \div | $x = 0$ |
| $\frac{1}{x}$ | $x = 0$ |
| \sqrt{x} | $x < 0$ |
| LN | $x \leq 0$ |
| y^x | $y = 0$ and $x \leq 0$ $y < 0$ and x is noninteger. |
| $\Delta\%$ | $y = 0$ |
| $\%T$ | $y = 0$ |
| STO \div (0 through 4) | $x = 0$ |
| $n!$ | x is noninteger $x < 0$ |

Error 1: Storage Register Overflow

| Operation | Condition |
|---|--|
| $\boxed{\text{STO}} \boxed{+}$ (0 through 4) $\boxed{\text{STO}} \boxed{-}$ (0 through 4) $\boxed{\text{STO}} \boxed{\times}$ (0 through 4) $\boxed{\text{STO}} \boxed{\div}$ (0 through 4) $\boxed{12X}$ | } Magnitude of result is greater than $9.99999999 \times 10^{99}$. |

Error 2: Statistics

| Operation | Condition |
|--|--|
| $\boxed{\bar{x}}$ | n (number in R_1) = 0 |
| $\boxed{\bar{x}_w}$ | $\Sigma x = 0$ |
| \boxed{s} | $n = 0$ $n = 1$ $n\Sigma x^2 - (\Sigma x)^2 < 0$ $n\Sigma y^2 - (\Sigma y)^2 < 0$ |
| $\boxed{\hat{y}_{,r}}$ | $n = 0$ $n\Sigma x^2 - (\Sigma x)^2 = 0$ |
| $\boxed{\hat{x}_{,r}}$ | $n = 0$ $n\Sigma y^2 - (\Sigma y)^2 = 0$ |
| $\boxed{\hat{y}_{,r}} \boxed{x \approx y}$ $\boxed{\hat{x}_{,r}} \boxed{x \approx y}$ | } $[n\Sigma x^2 - (\Sigma x)^2][n\Sigma y^2 - (\Sigma y)^2] \leq 0$ |

Error 3: IRR

Refer to Appendix C.

Error 4: Memory

- Attempting to enter more than 400 program lines.
- Attempting to $\boxed{\text{GTO}}$ to a program line that does not exist.
- Attempting storage register arithmetic in R_5 through R_9 or R_{10} through R_{19} .
- Too many open parentheses.

Error 5: Compound Interest

Operation

Condition

n

$i = 0$ and $PMT = 0$

PMT is between $FV \times d$ and $-PV \times d$, inclusive,

where $d = \frac{\left(\frac{i}{100}\right)}{\left(1 + i \times \frac{S}{100}\right)}$, where $S=0$ for END

mode and 1 for BEG mode.

$i \leq -100$

i

$n=0$

$n \geq 10^{10}$ or $n < 0$

$i \leq -100$

Cash flows all have same sign.

PV

$i \leq -100$

PMT

$n = 0$

$i \leq -100$

FV

$i \leq -100$

AMORT

$x \leq 0$

x is noninteger.

NPV

$i \leq -100$

SL

SOYD

DB

}

$n \leq 0$

$n > 10^{10}$

$x \leq 0$

x is noninteger

PRICE

$PMT < 0$

YTM

$PMT < 0$

Error 6: Storage Registers

| Operation | Condition |
|--|--|
| <div style="display: flex; align-items: center;"> <div style="margin-right: 10px;"> <div style="border: 1px solid black; padding: 2px; display: inline-block;">STO</div> </div> <div style="font-size: 2em; color: blue; margin-right: 10px;">}</div> </div> <div style="display: flex; align-items: center;"> <div style="margin-right: 10px;"> <div style="border: 1px solid black; padding: 2px; display: inline-block;">RCL</div> </div> <div style="font-size: 2em; color: blue;">}</div> </div> | Storage register specified does not exist or has been converted to program lines. |
| <div style="display: flex; align-items: center;"> <div style="margin-right: 10px;"> <div style="border: 1px solid black; padding: 2px; display: inline-block;">CF_i</div> </div> <div style="font-size: 2em; color: blue; margin-right: 10px;">}</div> </div> <div style="display: flex; align-items: center;"> <div style="margin-right: 10px;"> <div style="border: 1px solid black; padding: 2px; display: inline-block;">N_i</div> </div> <div style="font-size: 2em; color: blue;">}</div> </div> | <i>n</i> specifies a storage register that does not exist or has been converted to program lines. |
| <div style="display: flex; align-items: center;"> <div style="margin-right: 10px;"> <div style="border: 1px solid black; padding: 2px; display: inline-block;">NPV</div> </div> <div style="font-size: 2em; color: blue; margin-right: 10px;">}</div> </div> <div style="display: flex; align-items: center;"> <div style="margin-right: 10px;"> <div style="border: 1px solid black; padding: 2px; display: inline-block;">IRR</div> </div> <div style="font-size: 2em; color: blue;">}</div> </div> | $n > 80$ $n < 0$ <i>n</i> is noninteger |
| <div style="border: 1px solid black; padding: 2px; display: inline-block; margin-right: 10px;">N_i</div> | $x > 99$ $x < 0$ <i>x</i> is noninteger Attempted to input N _i for CF ₀ |

Error 7: IRR

Refer to Appendix C.

Error 8: Calendar

Operation

ADYS

DATE

DATE

PRICE

YTM

Condition

Improper date format or illegal date.

Attempting to add days beyond calculator's date capacity.

Improper date format or illegal date.

More than 500 years between settlement (purchase) date and maturity (redemption) date.

Maturity date earlier than settlement date.

Maturity date has no corresponding coupon date (6 months earlier).*

Error 9: Service

Refer to Appendix F.

Pr Error

- Continuous Memory has been reset. (Refer to Continuous Memory, page 86.)
- You have reset the calculator using the reset hole (see page 266).

* This is the case for the 31st of March, May, August, October, and December, plus August 29 (except in a leap year) and 30. For example, there is no September 31, so March 31 has no corresponding coupon date 6 months earlier.

To correct this problem for all maturity dates except August 29 and 30, add one day to *both* the settlement date *and* the maturity date in your calculations. For instance, if a bond were purchased on June 1, 2004 (the settlement date) with a maturity date of December 31, 2005, you should change the dates to June 2, 2004 and January 1, 2006 for your calculations.

For August 29 and 30, there is no calculator solution that gives the correct answer.

Appendix E

Formulas Used

Percentage

$$\% = \frac{\text{Base}(y) \times \text{Rate}(x)}{100}$$

$$\Delta\% = 100 \left(\frac{\text{NewAmount}(x) - \text{Base}(y)}{\text{Base}(y)} \right)$$

$$\%T = 100 \left(\frac{\text{Amount}(x)}{\text{Total}(y)} \right)$$

Interest

n = number of compounding periods.

i = periodic interest rate, expressed as a decimal.

PV = present value.

FV = future value or balance.

PMT = periodic payment.

S = payment mode factor (0 or 1) indicating treatment of PMT .
0 corresponds to End, 1 to Begin.

I = interest amount.

$\text{INTG}(n)$ = integer portion of n .

$\text{FRAC}(n)$ = fractional portion of n .

Simple Interest

$$I_{360} = \frac{n}{360} \times PV \times i$$

$$I_{365} = \frac{n}{365} \times PV \times i$$

Compound Interest

Without an odd period:

$$0 = PV + (1 + iS) \cdot PMT \cdot \left[\frac{1 - (1 + i)^{-n}}{i} \right] + FV(1 + i)^{-n}$$

With simple interest used for an odd period:

$$0 = PV[1 + i\text{FRAC}(n)] + (1 + iS)PMT \left[\frac{1 - (1 + i)^{-\text{INTG}(n)}}{i} \right] + FV(1 + i)^{-\text{INTG}(n)}$$

With compound interest used for an odd period:

$$0 = PV(1 + i)^{\text{FRAC}(n)} + (1 + iS)PMT \left[\frac{1 - (1 + i)^{-\text{INTG}(n)}}{i} \right] + FV(1 + i)^{-\text{INTG}(n)}$$

Amortization

n = number of payment periods to be amortized.

INT_j = amount of PMT applied to interest in period j .

PRN_j = amount of PMT applied to principal in period j .

PV_j = present value (balance) of loan after payment in period j .

j = period number.

INT_1 = {0 if $n = 0$ and payment mode is set to Begin.
 $|PV_0 \times i|_{\text{RND}}$ (sign of PMT)

$PRN_1 = PMT - INT_1$

$PV_1 = PV_0 + PRN_1$

$INT_j = |PV_{j-1} \times i|_{\text{RND}} \times (\text{sign of } PMT)$ for $j > 1$.

$PRN_j = PMT - INT_j$

$PV_j = PV_{j-1} + PRN_j$

$$\sum INT = \sum_{i=1}^n INT_i = INT_1 + INT_2 + \dots + INT_n$$

$$\sum PRN = \sum_{i=1}^n PRN_i = PRN_1 + PRN_2 + \dots + PRN_n$$

$$PV_n = PV_0 + \sum PRN$$

Discounted Cash Flow Analysis

Net Present Value

NPV = net present value of a discounted cash flow.

CF_j = cash flow at period j .

$$NPV = CF_0 + \frac{CF_1}{(1+i)^1} + \frac{CF_2}{(1+i)^2} + \dots + \frac{CF_n}{(1+i)^n}$$

Internal Rate of Return

n = number of cash flows

CF_j = cash flow at period j .

IRR = Internal Rate of Return

$$0 = \sum_{j=1}^k CF_j \cdot \left[\frac{1 - (1 + IRR)^{-n_j}}{IRR} \right] \cdot \left[(1 + IRR)^{-\sum_{q < j} n_q} \right] + CF_0$$

Calendar

Actual Day Basis

$$\Delta DYS = f(DT_2) - f(DT_1)$$

where

$$f(DT) = 365 (yyyy) + 31 (mm - 1) + dd + INTG (z/4) - x$$

and

for $mm \leq 2$

$$x = 0$$

$$z = (yyyy) - 1$$

for $mm > 2$

$$x = INTG (0.4mm + 2.3)$$

$$z = (yyyy)$$

INTG = Integer portion.

Note: Additional tests are performed in order to ensure that the century (but not millennium) years are not considered leap years.

30/360 Day Basis

$$DAYS = f(DT_2) - f(DT_1)$$

$$f(DT) = 360 (yyyy) + 30mm + z$$

for $f(DT_1)$

if $dd_1 = 31$ then $z = 30$

if $dd_1 \neq 31$ then $z = dd_1$

for $f(DT_2)$

if $dd_2 = 31$ and $dd_1 = 30$ or 31 then $z = 30$

if $dd_2 = 31$ and $dd_1 < 30$ then $z = dd_2$

if $dd_2 < 31$ then $z = dd_2$

Bonds

Reference:

Jan Mayle, TIPS Inc., *Standard Securities Calculation Methods*, Volume 1, Third Edition, Securities Industry Association Inc., New York, 1993.

DIM = days between issue date and maturity date.

DSM = days between settlement date and maturity date.

DCS = days between beginning of current coupon period and settlement date.

E = number of days in coupon period where settlement occurs.

DSC = $E - DCS$ = days from settlement date to next 6-month coupon date.

N = number of semiannual coupons payable between settlement date and maturity date.

CPN = annual coupon rate (as a percentage).

$YIELD$ = annual yield (as a percentage).

$PRICE$ = dollar price per \$100 par value.

RDV = redemption value.

For semiannual coupon with 6 months or less to maturity:

$$PRICE = \left[\frac{100(RDV + \frac{CPN}{2})}{100 + (\frac{DSM}{E} \times \frac{YIELD}{2})} \right] - \left[\frac{DCS}{E} \times \frac{CPN}{2} \right]$$

For semiannual coupon with more than 6 months to maturity:

$$PRICE = \left[\frac{RDV}{\left(1 + \frac{YIELD}{200}\right)^{N-1+\frac{DSC}{E}}} \right] + \left[\sum_{K=1}^N \frac{\frac{CPN}{2}}{\left(1 + \frac{YIELD}{200}\right)^{K-1+\frac{DSC}{E}}} \right] - \left[\frac{CPN}{2} \times \frac{DCS}{E} \right]$$

Black-Scholes Formula for Valuing European Options

P = current asset price.

$r\%$ = risk-free rate (continuous, per time unit).

$s\%$ = volatility (continuous, per time unit).

T = term of option (same time unit as $r\%$ and $s\%$).

X = exercise price of option.

$N(z)$ = probability that a unit normal random variable is less than z .

$$\text{Call Value} = P \times N(d_1) - Q \times N(d_2)$$

$$\text{Put Value} = \text{Call Value} + Q - P$$

where :

$$d_1 = \frac{\ln(P/Q) + v + v^2/2}{v}, \quad d_2 = d_1 - v$$

$$Q = X e^{(-T \times r\% / 100)}, \quad v = s\% / 100 \times \sqrt{T}$$

Depreciation

L = asset's useful life expectancy.

SBV = starting book value.

SAL = salvage value.

$FACT$ = declining-balance factor expressed as a percentage.

j = period number.

DPN_j = depreciation expense during period j .

RDV_j = remaining depreciable value at end of period j
 $= RDV_{j-1} - DPN_j$ where $RDV_0 = SBV - SAL$

RBV_j = remaining book value = $RBV_{j-1} - DPN_j$ where $RBV_0 = SBV$

Y_1 = number of months in partial first year.

Straight-Line Depreciation

Keyboard function:

$$DPN_j = \frac{SBV - SAL}{L} \quad \text{for } j = 1, 2, \dots, L$$

Program for partial first year:

$$DPN_1 = \frac{SBV - SAL}{L} \cdot \frac{Y_1}{12}$$

$$DPN_j = \frac{SBV - SAL}{L} \quad \text{for } j = 2, 3, \dots, L$$

$$DPN_{L+1} = RDV_L$$

Sum-of-the-Years-Digits Depreciation

$$SOYD_k = \frac{(W + 1)(W + 2F)}{2}$$

where W = integer part of k F = fractional part of k .(i.e., for $k = 12.25$ years, $W = 12$ and $F = 0.25$).

Keyboard function:

$$DPN_j = \frac{(L - j + 1)}{SOYD_L} \cdot (SBV - SAL)$$

Program for partial year:

$$DPN_1 = \left(\frac{L}{SOYD} \right) \cdot \left(\frac{Y_1}{12} \right) \cdot (SBV - SAL)$$

$$DPN_j = \left(\frac{LADJ - j + 2}{SOYD_{LADJ}} \right) \cdot (SBV - D_1 - SAL) \quad \text{for } j \neq 1$$

$$\text{where } LADJ = L - \left(\frac{Y_1}{12} \right)$$

Declining-Balance Depreciation

Keyboard function:

$$DPN_j = RBV_{j-1} \cdot \frac{FACT}{100L} \quad \text{for } j = 1, 2, \dots, L$$

Program for partial first year:

$$DPN_1 = SBV \cdot \frac{FACT}{100L} \cdot \frac{Y_1}{12}$$

$$DPN_i = RBV_{i-1} \cdot \frac{FACT}{100L} \text{ for } i \neq 1$$

Modified Internal Rate of Return

n = number of compounding periods.

NFV_p = Net future value of the positive cash flows.

NPV_N = Net present value of the negative cash flows.

$$MIRR = 100 \left[\left(\frac{NFV_p}{-NPV_N} \right)^{\frac{1}{n}} - 1 \right]$$

Advance Payments

A = number of payments made in advance.

$$PMT = \frac{PV - FV(1+i)^{-n}}{\left[\frac{1 - (1+i)^{-(n-A)}}{i} + A \right]}$$

Interest Rate Conversions

C = number of compounding periods per year.

EFF = the effective annual interest rate as a decimal.

NOM = the nominal annual interest rate as a decimal.

Finite Compounding

$$EFF = \left(1 + \frac{NOM}{C} \right)^C - 1$$

Continuous Compounding

$$EFF = (e^{NOM} - 1)$$

Statistics

Mean

$$\bar{x} = \frac{\sum x}{n} \quad \bar{y} = \frac{\sum y}{n}$$

Weighted Mean

$$\bar{x}_w = \frac{\sum wx}{\sum w}$$

Linear Estimation

n = number of data pairs

$$\hat{y} = A + Bx$$

$$\hat{x} = \frac{y - A}{B}$$

$$\text{where } B = \frac{\sum xy - \frac{\sum x \cdot \sum y}{n}}{\sum x^2 - \frac{(\sum x)^2}{n}}$$

$$A = \bar{y} - B\bar{x}$$

$$r = \frac{\left[\sum xy - \frac{\sum x \cdot \sum y}{n} \right]}{\sqrt{\left[\sum x^2 - \frac{(\sum x)^2}{n} \right] \cdot \left[\sum y^2 - \frac{(\sum y)^2}{n} \right]}}$$

Standard Deviation

$$s_x = \sqrt{\frac{n\sum x^2 - (\sum x)^2}{n(n-1)}} \quad s_y = \sqrt{\frac{n\sum y^2 - (\sum y)^2}{n(n-1)}}$$

Factorial

$$0! = 1$$

For $n > 1$ where n is an integer:

$$n! = \prod_{i=1}^n i$$

The Rent or Buy Decision

$$\text{Market Value} = \text{PRICE}(1 + I)^n$$

where:

$$I = \text{appreciation per year (as decimal)}$$

$$n = \text{number of years}$$

$$\text{Net Cash Proceeds on Resale} = \text{Market Value} - \text{Mortgage Balance} - \text{Commission}$$

The interest rate is obtained by solving the financial (compound interest) equation for i using:

$$n = \text{number of years house is owned}$$

$$PV = \text{down payment} + \text{closing costs}$$

$$\text{PMT} = \text{mortgage payment} + \text{taxes} + \text{maintenance} - \text{rent} - (\% \text{ tax}) \\ (\text{interest} + \text{taxes})$$

$$FV = \text{net cash proceeds on resale}$$

$$\text{Annual interest rate} = 12 \times i$$

Appendix F

Batteries, Warranty, and Service Information

Batteries

The hp 12c platinum is shipped with two 3 Volt CR2032 Lithium batteries. Battery life depends on how the calculator is used. If the calculator is being used to perform operations other than running programs, it uses much less power.

Low-Power Indication

A battery symbol (🔋) shown in the upper-left corner of the display when the calculator is on signifies that the available battery power is running low. When the battery symbol begins flashing, replace the battery as soon as possible to avoid losing data.

Use only a fresh battery. Do not use rechargeable batteries.

Warning



There is the danger of explosion if the battery is incorrectly replaced. Replace only with the same or equivalent type recommended by the manufacturer. Dispose of used batteries according to the manufacturer's instructions. Do not mutilate, puncture, or dispose of batteries in fire. The batteries can burst or explode, releasing hazardous chemicals. Replacement battery is a Lithium 3V Coin Type CR2032.

Installing a New Batteries

To prevent memory loss, never remove two old batteries at the same time. Be sure to remove and replace the batteries one at a time.

To install new batteries, use the following procedure:

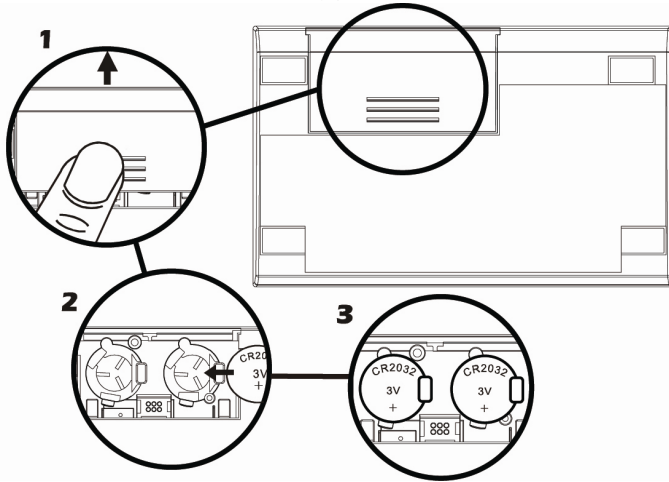

1. With the calculator turned off, slide the battery cover off.
2. Remove the old battery.
3. Insert a new CR2032 lithium battery, making sure that the positive sign (+) is facing outward.
4. Remove and insert the other battery as in steps 2 through 3. Make sure that the positive sign (+) on each battery is facing outward.
5. Replace the battery cover.

Note: Be careful not to press any keys while the battery is out of the calculator. If you do so, the contents of Continuous Memory may be lost and keyboard control may be lost (that is, the calculator may not respond to keystrokes).

6. Press **ON** to turn on the power. If for any reason Continuous Memory has been reset (that is, if its contents have been lost), the display will show **Pr Error**. Pressing any key will clear this message.

Verifying Proper Operation (Self-Tests)

If it appears that the calculator will not turn on or otherwise is not operating properly, use one of the following procedures.

For a calculator that does not respond to keystrokes:

1. Insert a thin, pointed object all the way into the reset hole near the battery compartment and then remove it.

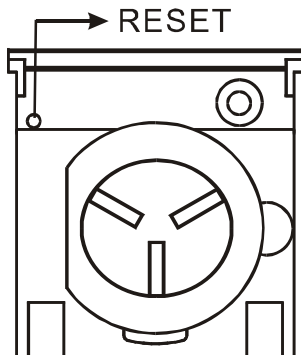

2. The display will show **Pr Error**. Pressing any key will clear this message from the display.
3. If the calculator still does not respond to keystrokes, remove and reinsert the battery. Make sure that the battery is properly positioned in the battery compartment.
4. If the calculator does not turn on, install a fresh battery. If there is still no response, the calculator requires service.

For a calculator that does respond to keystrokes:

1. With the calculator off, hold down the **ON** key and press **X**.
2. Release the **ON** key, then release the **X** key. This initiates a complete test of the calculator's electronic circuitry. If everything is working correctly, within about 25 seconds (during which the word **running** flashes) the display should show **-8,8,8,8,8,8,8,8,8**, and all of the status indicators (except the  battery power indicator) should turn on.* If the display shows **Error 9**, goes blank, or otherwise does not show the proper result, the calculator requires service.†

* The status indicators turned on at the end of this test include some that normally are not displayed on the hp 12c platinum.

† If the calculator displays **Error 9** as a result of the **ON/X** test or the **ON/+** test but you wish to continue using your calculator, you should reset Continuous Memory as described on page 86.

Note: Tests of the calculator's electronics are also performed if the $\boxed{+}$ key or the $\boxed{\div}$ key is held down when $\boxed{\text{ON}}$ is released.* These tests are included in the calculator to be used in verifying that it is operating properly during manufacturing and service.

If you had suspected that the calculator was not working properly but the proper display was obtained in step 2, it is likely that you made an error in operating the calculator. We suggest you reread the section in this handbook applicable to your calculation — including, if appropriate, Appendix A. If you still experience difficulty, write or telephone Hewlett-Packard at an address or phone number listed under Service (Page 264).

Perchlorate Material – special handling may apply.

This calculator's battery may contain perchlorate and may require special handling when recycled or disposed in California

* The $\boxed{\text{ON}}/\boxed{+}$ combination initiates a test that is similar to that described above, but continues indefinitely. The test can be terminated by pressing any key, which will halt the test within 25 seconds. The $\boxed{\text{ON}}/\boxed{\div}$ combination initiates a test of the keyboard and the display. When the $\boxed{\text{ON}}$ key is released, certain segments in the display will be lit. To run the test, the keys are pressed in order from left to right along each row, from the top row to the bottom row. As each key is pressed, different segments in the display are lit. If the calculator is operating properly *and all the keys are pressed in the proper order*, the calculator will display **12** after the last key is pressed. (The $\boxed{\text{ENTER}}$ key should be pressed both with the third-row keys and with the fourth-row keys.) If the calculator is not working properly, *or if a key is pressed out of order*, the calculator will display **Error 9**. *Note that if this error display results from an incorrect key being pressed, this does not indicate that your calculator requires service.* This test can be terminated by pressing any key out of order (which will, of course, result in the **Error 9** display). Both the **Error 9** display and the **12** display can be cleared by pressing any key.

HP Limited Hardware Warranty and Customer Care

This HP Limited Warranty gives you, the end-user customer, express limited warranty rights from HP, the manufacturer. Please refer to HP's Web site for an extensive description of your limited warranty entitlements. In addition, you may also have other legal rights under applicable local law or special written agreement with HP.

Limited Hardware Warranty Period

Duration: 12 months total (may vary by region, please visit www.hp.com/support for latest information)

General Terms

HP warrants to you, the end-user customer, that HP hardware, accessories and supplies will be free from defects in materials and workmanship after the date of purchase, for the period specified above. If HP receives notice of such defects during the warranty period, HP will, at its option, either repair or replace products which prove to be defective. Replacement products may be either new or like-new.

HP warrants to you that HP software will not fail to execute its programming instructions after the date of purchase, for the period specified above, due to defects in material and workmanship when properly installed and used. If HP receives notice of such defects during the warranty period, HP will replace software media which does not execute its programming instructions due to such defects.

HP does not warrant that the operation of HP products will be uninterrupted or error free. If HP is unable, within a reasonable time, to repair or replace any product to a condition as warranted, you will be entitled to a refund of the purchase price upon prompt return of the product with proof of purchase.

HP products may contain remanufactured parts equivalent to new in performance or may have been subject to incidental use.

Warranty does not apply to defects resulting from (a) improper or inadequate maintenance or calibration, (b) software, interfacing, parts or supplies not supplied by HP, (c) unauthorized modification or misuse, (d) operation outside of the published environmental specifications for the product, or (e) improper site preparation or maintenance.

HP MAKES NO OTHER EXPRESS WARRANTY OR CONDITION WHETHER WRITTEN OR ORAL. TO THE EXTENT ALLOWED BY LOCAL LAW, ANY IMPLIED WARRANTY OR CONDITION OF MERCHANTABILITY, SATISFACTORY QUALITY,

OR FITNESS FOR A PARTICULAR PURPOSE IS LIMITED TO THE DURATION OF THE EXPRESS WARRANTY SET FORTH ABOVE. Some countries, states or provinces do not allow limitations on the duration of an implied warranty, so the above limitation or exclusion might not apply to you. This warranty gives you specific legal rights and you might also have other rights that vary from country to country, state to state, or province to province.

TO THE EXTENT ALLOWED BY LOCAL LAW, THE REMEDIES IN THIS WARRANTY STATEMENT ARE YOUR SOLE AND EXCLUSIVE REMEDIES. EXCEPT AS INDICATED ABOVE, IN NO EVENT WILL HP OR ITS SUPPLIERS BE LIABLE FOR LOSS OF DATA OR FOR DIRECT, SPECIAL, INCIDENTAL, CONSEQUENTIAL (INCLUDING LOST PROFIT OR DATA), OR OTHER DAMAGE, WHETHER BASED IN CONTRACT, TORT, OR OTHERWISE. Some countries, States or provinces do not allow the exclusion or limitation of incidental or consequential damages, so the above limitation or exclusion may not apply to you.

The only warranties for HP products and services are set forth in the express warranty statements accompanying such products and services. HP shall not be liable for technical or editorial errors or omissions contained herein.

FOR CONSUMER TRANSACTIONS IN AUSTRALIA AND NEW ZEALAND: THE WARRANTY TERMS CONTAINED IN THIS STATEMENT, EXCEPT TO THE EXTENT LAWFULLY PERMITTED, DO NOT EXCLUDE, RESTRICT OR MODIFY AND ARE IN ADDITION TO THE MANDATORY STATUTORY RIGHTS APPLICABLE TO THE SALE OF THIS PRODUCT TO YOU.

Customer Care

In addition to the one year hardware warranty your HP calculator also comes with one year of technical support. If you need assistance, HP customer care can be reached by either email or telephone. Before calling please locate the call center nearest you from the list below. Have your proof of purchase and calculator serial number ready when you call.

Telephone numbers are subject to change, and local and national telephone rates may apply. A complete list is available on the web at: www.hp.com/support.

| | |
|------------------|--|
| Africa (English) | www.hp.com/support |
| Africa (French) | www.hp.com/support |
| Argentina | 0-800-555-5000 |
| Australia | 1300-551-664 |

| | |
|---------------------------|--|
| Mexico | 01-800-474-68368 |
| Middle East International | www.hp.com/support |
| Netherlands | 020 654 5301 |
| New | 0800-551-664 |

270 Appendix F: Battery, Warranty, and Service Information

| | |
|----------------------|--|
| | |
| Austria | 01 360 277 1203 |
| Belgium (French) | 02 620 00 85 |
| Belgium (English) | 02 620 00 86 |
| Bolivia | 800-100-193 |
| Brasil | 0-800-709-7751 |
| Canada | 800-HP-INVENT |
| Caribbean | 1-800-711-2884 |
| Chile | 800-360-999 |
| China | 010-68002397 |
| Colombia | 01-8000-51- 4746-8368 |
| Costa Rica | 0-800-011-0524 |
| Czech Republic | 296 335 612 |
| Denmark | 82 33 28 44 |
| Ecuador | 800-711-2884 |
| El Salvador | 800-6160 |
| Finland | 09 8171 0281 |
| France | 01 4993 9006 |
| Germany | 069 9530 7103 |
| Greece | 210 969 6421 |
| Guatemala | 1-800-999-5105 |
| Honduras | 800-711-2884 |
| Hong Kong | 852 2833-1111 |
| Hungary | www.hp.com/support |
| India | www.hp.com/support/india |
| Indonesia | +65 6100 6682 |
| Ireland | 01 605 0356 |

| | |
|--------------------------|--|
| Zealand | |
| Nicaragua | 1-800-711-2884 |
| Norway | 23500027 |
| Panama | 001-800-711-2884 |
| Paraguay | (009) 800-541-0006 |
| Peru | 0-800-10111 |
| Philippines | +65 6100 6682 |
| Poland | www.hp.com/support |
| Portugal | 021 318 0093 |
| Puerto Rico | 1-877 232 0589 |
| Russia | 495 228 3050 |
| Singapore | 6100 6682 |
| South Africa | 0800980410 |
| South Korea | 2-561-2700 |
| Spain | 913753382 |
| Sweden | 08 5199 2065 |
| Switzerland (French) | 022 827 8780 |
| Switzerland (German) | 01 439 5358 |
| Switzerland (Italian) | 022 567 5308 |
| Taiwan | +852 2805-2563 |
| Thailand | +65 6100 6682 |
| Turkey | www.hp.com/support |
| United Kingdom | 0207 458 0161 |
| Uruguay | 0004-054-177 |
| United States | 800-HP INVENT |
| Venezuela | 0-800-474-68368 |
| Vietnam | +65 6100 6682 |

| | |
|----------|---|
| Italy | 02 754 19 782 |
| Japan | 81-3-6666-9925 |
| Korea | www.hp.com/support /korea |
| Malaysia | +65 6100 6682 |

| | |
|--|--|
| | |
| | |
| | |
| | |

Regulatory Information

Federal Communications Commission Notice

This equipment has been tested and found to comply with the limits for a Class B digital device, pursuant to Part 15 of the FCC Rules. These limits are designed to provide reasonable protection against harmful interference in a residential installation. This equipment generates, uses, and can radiate radio frequency energy and, if not installed and used in accordance with the instructions, may cause harmful interference to radio communications. However, there is no guarantee that interference will not occur in a particular installation. If this equipment does cause harmful interference to radio or television reception, which can be determined by turning the equipment off and on, the user is encouraged to try to correct the interference by one or more of the following measures:

- Reorient or relocate the receiving antenna.
- Increase the separation between the equipment and the receiver.
- Connect the equipment into an outlet on a circuit different from that to which the receiver is connected.
- Consult the dealer or an experienced radio or television technician for help.

Modifications

The FCC requires the user to be notified that any changes or modifications made to this device that are not expressly approved by Hewlett-Packard Company may void the user's authority to operate the equipment.

Declaration of Conformity for Products Marked with FCC Logo, United States Only

This device complies with Part 15 of the FCC Rules. Operation is subject to the following two conditions: (1) this device may not cause harmful interference, and (2) this device must accept any interference received, including interference that may cause undesired operation.

If you have questions about the product that are not related to this declaration, write to

Hewlett-Packard Company
P. O. Box 692000, Mail Stop 530113
Houston, TX 77269-2000

For questions regarding this FCC declaration, write to

Hewlett-Packard Company
 P. O. Box 692000, Mail Stop 510101
 Houston, TX 77269-2000
 or call HP at 281-514-3333

To identify your product, refer to the part, series, or model number located on the product.

Canadian Notice

This Class B digital apparatus meets all requirements of the Canadian Interference-Causing Equipment Regulations.

Avis Canadien



Cet appareil numérique de la classe B respecte toutes les exigences du Règlement sur le matériel brouilleur du Canada.

European Union Regulatory Notice

This product complies with the following EU Directives:

- Low Voltage Directive 2006/95/EC
- EMC Directive 2004/108/EC

Compliance with these directives implies conformity to applicable harmonized European standards (European Norms) which are listed on the EU Declaration of Conformity issued by Hewlett-Packard for this product or product family. This compliance is indicated by the following conformity marking placed on the product:

| | |
|--|---|
|  This marking is valid for non-Telecom products and EU harmonized Telecom products (e.g. Bluetooth). |  This marking is valid for EU non-harmonized Telecom products . *Notified body number (used only if applicable - refer to the product label) |
|--|---|

Hewlett-Packard GmbH, HQ-TRE, Herrenberger Strasse 140, 71034 Boeblingen, Germany

Japanese Notice

この装置は、情報処理装置等電波障害自主規制協議会（VCCI）の基準に基づくクラスB情報技術装置です。この装置は、家庭環境で使用することを目的としていますが、この装置がラジオやテレビジョン受信機に近接して使用されると、受信障害を引き起こすことがあります。

取扱説明書に従って正しい取り扱いをして下さい。

Disposal of Waste Equipment by Users in Private Household in the European Union



This symbol on the product or on its packaging indicates that this product must not be disposed of with your other household waste. Instead, it is your responsibility to dispose of your waste equipment by handing it over to a designated collection point for the recycling of waste electrical and electronic equipment. The separate collection and recycling of your waste equipment at the time of disposal will help to conserve natural resources

ensure that it is recycled in a manner that protects human health and the environment. For more information about where you can drop off your waste equipment for recycling, please contact your local city office, your household waste disposal service or the shop where you purchased the product.

Perchlorate Material - special handling may apply

This calculator's Memory Backup battery may contain perchlorate and may require special handling when recycled or disposed in California.

Chemical substances

HP is committed to providing our customers with information about the chemical substances in our products as needed to comply with legal requirements such as REACH (Regulation EC No 1907/2006 of the European Parliament and the Council). A chemical information report for this product can be found at: www.hp.com/go/reach.

Appendix G

United Kingdom Calculations

The calculations for most financial problems in the United Kingdom are identical to the calculations for those problems in the United States — which are described earlier in this handbook. Certain problems, however, require different calculation methods in the United Kingdom than in the United States, even though the terminology describing the problems may be similar. Therefore, it is recommended that you ascertain the usual practice in the United Kingdom for the financial problem you are solving.

The remainder of this appendix describes three types of financial calculations for which the conventional practice differs significantly between the United Kingdom and the United States.

Mortgages

The amount of the repayments on home loans and mortgages offered by *banks* in the United Kingdom can usually be calculated as described under Calculating the Payment Amount, page 59. Building Societies in the United Kingdom, however, calculate the amount of these repayments differently. In general, the repayment amount of a Building Society mortgage is calculated as follows: first, the *annual* repayment amount is calculated using the annual interest rate; second, the *periodic* repayment amount is calculated by dividing the annual repayment amount by the number of repayment periods in one year.

Furthermore, the calculations used by Building Societies are rounded; therefore, to match their scale repayment figures you would have to round your calculations accordingly.

Annual Percentage Rate (APR) Calculations

In the United Kingdom, the calculation of the Annual Percentage Rate of Charge (APR) in accordance with the United Kingdom Consumer Credit Act (1974) differs from the calculation of the APR in the United States. Unlike the practice in the United States, where the APR can be calculated by multiplying the periodic interest rate by the number of periods per year, in the United Kingdom the APR is calculated by converting the periodic interest rate to the “effective annual rate,” then rounding the result to one decimal place. With the periodic interest rate in the display and in the *i* register and the payment mode set to End, the effective annual rate can be calculated by pressing $\boxed{\text{CHS}}\boxed{\text{PMT}}$, then keying in the number of compounding periods per year and pressing $\boxed{n}\boxed{0}\boxed{\text{PV}}\boxed{\text{FV}}$. Pressing $\boxed{f}\boxed{1}$ will then display the rounded APR.

Bond Calculations

Solutions for the price and yield to maturity of United Kingdom bonds are not included in this handbook. Actual practice differs according to the type of bond; variations such as cumulative and ex-dividend pricing, simple or compound interest discounting, etc., may be encountered.

Application Notes covering such situations may be available in the United Kingdom; check with your local authorized Hewlett-Packard dealer.

Function Key Index

General

[ON] Power on /off key
(page 16).

[f] Shift key. Selects alternate function in gold above the function keys (page 16). Also used in display formatting (page 87).

[g] Shift key. Selects alternate function in blue on the slanted face of the function keys (page 16).

[f] CLEAR^{PREFIX} after **[f]**, **[g]**, **[STO]**, **[RCL]** or **[GTO]**, cancels that key (page 19).

[f] CLEAR^{PREFIX} also displays mantissa of number in the displayed X-register (page 89).

[←] Backspacing. Deletes last character or a number. (page 18).

[↶] Undo. Recovers the last operation. (page 19).

Digit Entry

[ENTER] Enters a copy of number in displayed X-register into Y-register. Used to separate numbers (pages 21 and 233).

[CHS] Changes sign of number or exponent of 10 in X-register (page 17).

[EEX] Enter exponent. After pressing, next numbers keyed in are exponents of 10 (page 18).

[0]–[9] digits. Used for keying in numbers (page 21) and display formatting (page 87).

[.] Decimal point (page 17). Also used for display formatting (page 87).

[CLX] Clears contents of displayed X-register to zero (page 19).

Arithmetic

[+] **[−]** **[X]** **[÷]** **[=]** Arithmetic operators (page 21).

Storage Registers

[STO] Store. Followed by number key, decimal point and number key, or top row financial key, stores displayed number in storage register specified (page 27). Also used to perform storage register arithmetic (page 29).

[RCL] Recall. Followed by number key, decimal point and number key, or top-row financial key, recalls value from storage register specified into the displayed X-register (page 27).

CLEAR [REG] Clears contents of stack (X,Y,Z and T), all storage registers, statistical registers, and financial registers (page 28). Leaves program memory untouched; not programmable.

Percentage

[%] Computes x% of y and retains the y-value in the Y-register (page 31).

[Δ%] Computes percent of change between number in Y-register and number in displayed X-register (page 33).

[%T] Computes percent that x is of number in Y-register (page 35).

Calendar

[D.MY] Sets date format to day-month-year (page 38); not programmable.

[M.DY] Sets date format to month-day-year (page 37); not programmable.

[DATE] Changes a date in the Y-register by the number of days in the X-register and displays day of week (page 38).

[ΔDYS] Computes the number of days between

two dates in the Y and X-registers (**page 40**).

Financial

CLEAR Clears

Stores or computes future value (final cash flow) of a financial

Calculates depreciation using straight-line method.

contents of financial registers **(page 42)**.

[BEG] Sets payment mode to Begin for compound interest calculations involving payments **(page 46)**.

[END] Sets payment mode to End for compound interest calculations involving payments **(page 46)**.

[INT] Calculates simple interest **(page 42)**.

[n] Stores or computes number of periods in financial problem **(page 41)**.

[12X] Multiplies a number in displayed X-register by 12 and stores the resulting value in the n-register **(page 49)**.

[i] Stores or computes interest rate per compounding period **(page 41)**.

[12÷] Divides number in displayed X-register by 12 and stores the resulting value in the i-register **(page 49)**.

[PV] Stores or computes the present value (that is, the initial cash flow) of a financial problem **(page 41)**.

[PMT] Stores or computes payment amount **(page 41)**.

problem **(page 41)**.

[AMORT] Amortizes x number of periods using values stored in PMT, i , PV, and the display. Updates values in PV and n **(page 69)**.

[NPV] Calculates the net present value of up to 80 uneven cash flows and initial investment using values stored with **[CF₀]**, **[CF₁]**, and **[N₁]** **(page 73)**.

[IRR] Calculates the internal rate of return (yield) for up to 80 uneven cash flows and initial investment using values stored with **[CF₀]**, **[CF₁]**, and **[N₁]** **(page 78)**.

[CF₀] Initial cash flow. Stores contents of displayed X-register in R_0 , initializes n to zero, sets N_0 to 1. Used at the beginning of a discounted cash flow problem **(page 73)**.

[CF₁] Cash flow j . Stores the contents of X-register in R_j , increments n by 1, and sets N_j to 1. Used for all cash flows except the initial cash flow in a discounted cash flow problem **(page 73)**.

(page 83).

[PRICE] Calculates bond price, given desired yield to maturity **(page 82)**.

[YTM] Calculates yield to maturity, given bond price **(page 83)**.

[N₁] Stores the number (from 1 to 99) of times each cash flow occurs as N_j . Assumes 1 unless otherwise specified **(page 75)**.

[SOYD] Calculates depreciation using sum-of-the-years-digits method **(page 83)**.

[DB] Calculates depreciation using declining-balance method **(page 83)**.

Statistics

CLEAR[Σ] Clears statistical storage registers R_1 through R_6 and stack registers **(page 93)**.

[Σ+] Accumulates statistics using numbers from X- and Y-registers in storage registers R_1 through R_6 **(page 93)**.

[Σ-] Cancels effect of numbers from X- and Y-registers in storage registers R_1 through R_6 **(page 94)**.

\bar{x} Computes mean (average) of x -values and y -values using accumulated statistics (page 94).

\bar{x}_w Computes weighted average of y -(item) and x -(weight) values using accumulated statistics (page 99).

S Computes sample standard deviations of x - and y -values using accumulated statistics (page 96).

\hat{y}_r Linear estimate (X-register), correlation coefficient (Y-register). Fits a line to a set of (x, y) data pairs entered using $\Sigma+$, then extrapolates this line to estimate a y -value for a given x -value. Also computes strength of linear relationship (r) among that set of (x, y) data pairs (page 97).

\hat{x}_r Linear estimate (X-register), correlation coefficient (Y-register). Fits a line to a set of (x, y) data pairs entered using $\Sigma+$, then extrapolates this line to estimate an x -value for a given y -value. Also computes strength of linear relationship (r) among that set of (x, y) data pairs (page 97).

Modes

RPN sets calculator to RPN mode (page 19).

ALG sets calculator to algebraic (ALG) mode (page 19).

Mathematics

\sqrt{x} Computes square root of number in displayed X-register (page 100).

y^x Raises number in Y-register to power of number in X-register (page 102).

$1/x$ Computes reciprocal of number in displayed X-register (page 100).

$n!$ Computes factorial [$n \cdot (n-1) \dots 3 \cdot 2 \cdot 1$] of number in displayed X-register (page 100).

e^x Natural antilogarithm. Raises e (approximately 2.718281828) to power of number in displayed X-register (page 100).

LN Computes natural logarithm (base e) of number in displayed X-register (page 100).

x^2 Computes square of the number displayed in the X-register (page 100).

Number Alteration

RND Rounds mantissa of 10-digit number in X-register to match the display (page 100).

INTG Leaves only the integer portion of number in displayed X-register by truncating fractional portion (page 101).

FRAC Leaves only the fractional portion of number in displayed X-register by truncating integer portion (page 101).

Stack Rearrangement

$()$ Opens and closes parenthesis in ALG mode. (page 244)

$X \leftrightarrow Y$ Exchanges contents of X and Y-registers of stack (pages 90 and 234).

$\text{R}\downarrow$ Rolls down contents of stack for viewing in displayed X-register (page 235).

LSTX Recalls number displayed before the previous operation back into the displayed X-register (pages 90 and 238).

Programming Key Index

P/R Program/Run. Toggles into and out of Program mode. Automatically sets program to line 000 when returning to Run mode (**page 86**).

MEM Memory map. Describes the current allocation of memory; the number of lines allotted to program memory and the number of available data registers (**page 93**).

| Program Mode | Run Mode | |
|---|---|--|
| <p>In <i>Program</i> mode, function keys are recorded in program memory. Display shows program memory line number and the keycode (keyboard row and location in row) of the function key.</p> | <p>In <i>Run</i> mode, function keys may be executed as part of a recorded program or individually by pressing from the keyboard.</p> | |
| <p>Active Keys: In Program mode only the following keys are active; they cannot be recorded in program memory.</p> <p>CLEAR_{PRGM} Clear program. Clears program memory to all GTO000 instructions and resets calculator so operations begin at line 000 of program memory. Resets MEM to P008 r20 (page 115)</p> | <p>Pressed from keyboard:</p> <p>CLEAR_{PRGM} Resets calculator (in Run mode) so operations begin at line 000 of program memory. Does not erase program memory.</p> | <p>Executed as a recorded program instruction</p> |

| Program Mode | Run Mode | |
|---|--|--|
| <p style="text-align: center;">Active Keys:</p> <p>[GTO] Go to. Followed by a decimal point and a three-digit number, positions calculator to that line in program memory. No instructions are executed (page 116).</p> <p>[SST] Single step. Displays line number and contents of next program memory line. If held down, displays line number and contents of all program memory lines, one at a time (page 111).</p> <p>[BST] Back step. Displays line number and contents of previous program memory line. When back stepped from line 000, goes to end of program memory as defined by [g MEM]. If held down, displays line number and contents of all program memory lines, one at a time (page 115).</p> | <p style="text-align: center;">Pressed from keyboard:</p> <p>[R/S] Run/Stop. Begins execution of a stored program. Stops execution if program is running (page 108).</p> <p>[GTO] Go to. Followed by a three-digit number, positions calculator to that line in program memory. No instructions are executed (page 127).</p> <p>[SST] Single step. Displays line number and keycode of current program memory line when pressed; executes instruction, displays result, and moves to next line when released (page 116).</p> <p>[BST] Back step. Displays line number and keycode of previous program memory line when pressed; displays original contents of X-register when released. No instructions are executed (page 118).</p> <p>Any key. Pressing any key on the keyboard stops execution of a program (page 126).</p> | <p style="text-align: center;">Executed as a recorded program instruction:</p> <p>[R/S] Run/Stop. Stops program execution (page 124).</p> <p>[GTO] Go to. Followed by a three-digit number, causes calculator to branch to the specified line number next, and resumes program execution from there (page 127).</p> <p>[PSE] Pause. Stops program execution for about 1 second and displays contents of X-register, then resumes program execution (page 119).</p> <p>[x≤y] [x=0] Conditional. [x≤y] tests number in X-register against that in Y-register. [x=0] tests number in X-register against zero. If true, calculator continues execution at next program memory line. If false, calculator skips next line before resuming execution (page 131).</p> |

Subject Index

A

AMORT, 13, 69, 230
Adding instructions, 140–48
Adjusting the Display Contrast, 16
Advance payments, 202, 209
Algebraic mode, 20, 237
Amortization, 48, 69–71, 251
Annual interest rate, 49
Annual Percentage Rate, 65–68, 156–59, 271
Annuities, 45
Annuities, deferred, 169–70
Annuity due, 47–48
Appreciation, 48
APR. *See* Annual Percentage Rate
Arithmetic calculations with constants, 91, 235
Arithmetic calculations, chain, 23–25
Arithmetic calculations, simple, 21, 22
Arithmetic operations and the stack, 231
Arithmetic, storage register, 29
Average. *See* Mean

B

BEG, 46
BST, 109, 116, 139
←, 18
Backstep, 109
Balloon payments, 50, 52
Battery, 259
Battery power, low, 13, 16, 259
Battery, installing, 260
BEGIN status indicator, 47
Black-Scholes formula for valuing

European options, 194, 254
Bonds, 82–83, 217–25, 253, 271
Bonds, 30/360 day basis, 217–21
Bonds, annual coupon, 222
Bonds, corporate, 82
Bonds, municipal, 82
Bonds, U.S. Treasury, 82
Branching, 125–38, 144
Branching, adding instructions by, 144–48
Branching, conditional, 129–30
Branching, simple, 125

C

CF0, 74, 76
CF1, 73, 74, 76, 79
CHS, 17, 21, 42, 73, 230
CLX, 19, 35, 230, 234, 236
C status indicator, 65
Calendar functions, 37–40, 252
Calendar functions and the stack, 233
Cash flow diagram, 44–48
Cash flow sign convention, 42, 46
Cash flows, changing, 80
Cash flows, reviewing, 79
Cash flows, storing for **NPV** and **IRR**, 73, 80
Chain calculations, 23–25, 26, 234, 238
Clearing display, 19
Clearing financial registers, 19
Clearing operations, 17, 19
Clearing prefix keys, 17
Clearing program memory, 19, 105
Clearing statistics registers, 19, 93
Clearing storage registers, 19, 29, 86
Clearing X-register, 19

Compound growth, 47, 49
 Compound interest, 49–68, 251
 Compound interest calculation, 12
 Compounding periods, 44, 49
 Conditional branching, 129–30
 Conditional test instructions, 129
 Constants, arithmetic calculations with, 235
 Constants, arithmetic calculations with, 91
 Continuous compounding, 216, 256
 Continuous memory, 86
 Continuous memory, resetting of, 42, 47, 86, 88, 112
 Continuous rate, 216

D

DATE, 37–40
DB, 84, 230
ADYS, 65, 230
DMY, 38
 D.MY status indicator, 38
 Data storage registers, 27–30
 Date format, 37, 86
 Dates, days between, 40
 Dates, future or past, 38
 Days, between dates, 40
 Decimal places, rounding, 87
 Decimal point, changing, 17
 Declining-balance depreciation, 176
 Deferred annuities, 169–70
 Depreciation, 84, 171–91, 254–56
 Depreciation, declining-balance, 176
 Depreciation, excess, 191
 Depreciation, partial year, 171–91
 Depreciation, sum-of-the-years-digits, 180
 Depreciation, with crossover, 184–91
 Digit entry, recovering from errors in, 92
 Digit entry, termination of, 21, 229
 Discounted cashflow analysis, 72
 Display, 87

Display format, mantissa, 89
 Display format, standard, 88
 Display formats, number, 87
 Display, scientific notation, 88
 Displaying numbers, 41
 Displays, special, 90

E

EEX, 18, 21, 65, 230
END, 46
ENTER, 21, 31, 36, 93, 99, 102, 129, 229, 234
 e^x , 100, 231
=, 20, 22, 26, 237
 Editing a program, 139
 Effective interest rate, converting, 215
 Effective rate, 216
 Entry errors, 92
 Error conditions, 90
 Error, Pr, 90
 Errors, 90
 Errors, in digit entry, 92
 Excess depreciation, 191
 Exponent, 18, 102
 Exponential, 100

F

f, 16, 21, 69, 88, 108, 230
FIN, 19, 42
FRAC, 101, 231
FV, 41, 61
 Factorial, 100
 Financial registers, 41
 Financial registers, clearing, 42
 Fractional, 101
 Future value, 46
 Future value, calculating, 61
 FV, 46

G

g, 16, 21, 108, 112, 230

286 Subject Index

GTO, 17, 21, 108, 114, 125, 130,
143, 230

GTO **□**, 114, 139

GTO000, 112–13

I

i, 13, 41, 42

INT, 42, 230

IRR, 13, 72, 73, 78, 243

INTG, 101, 231

Indicators, status, 87

Instructions in program lines, 108

Interest rate, annual, 55

Interest rate, periodic, 55

Interest, simple, 42

Internal rate of return, 72

Internal rate of return, calculating,
78

Internal rate of return, modified, 192

Interrupting a program, 117

IRR, 72, 192

K

Keyboard, 16

L

LSTx, 91, 101, 234

LN, 100, 231

LAST X register, 86

Leasing, 202

Linear estimation, 97

Logarithm, 100

Looping, 125

Low-power indicator, 16

M

M.DY, 37

MEM, 113

Mantissa, 18, 89

Mantissa Display Format, 89

Mean, 94

Mean, weighted, 99

memory, 27

Memory, program, 112

Modes

algebraic, 20

RPN, 20

Modified internal rate of return, 192

Mortgage, price of, 159

Mortgage, yield of, 161

Multiple programs, 149

N

n, 41, 49

n!, 100, 231

Ni, 75, 79, 80

NPV, 72, 73

Negative numbers, 17, 238

Net amount, 33

Net present value, 72

Net present value, calculating, 73

Nominal interest rate, converting,
213

NPV, 72

Number display formats, 87

Numbers, keying in, 17

Numbers, large, 18

Numbers, negative, 17

Numbers, recalling, 27

Numbers, storing, 27

O

ON, 16, 260

Odd-period calculations, 63

Odd-period mode, 45

One-number functions, 100

One-variable statistics, 93

Overflow, 90

P

P/R, 104, 106, 109, 124

PMT, 41, 59

PREFIX, 17, 89

PRGM, 19, 104, 112

PRICE, 82, 230
PSE, 117, 118
PV, 41, 42, 55
 Parentheses Calculations, 26, 240
 Partial-year depreciation, 171
 Payment, 45, 209
 Payment amount, calculating, 59
 Payment mode, 46
 Payments, advance, 202, 209
 Payments, number of, 49
 Percent difference, 34, 241
 Percent of total, 35, 242
 Percentages, 31, 32, 241
 PMT, 45
 Populations, 96
 Power function, 102, 242
 Pr error, 90
 Prefix key, 16
 Present value, 45
 Present value, calculating, 56
 PRGM status indicator, 104, 106
 Program branching, 125
 Program editing, 139
 Program lines, displaying, 109
 Program looping, 125
 Program memory, 108, 112
 Program mode, 104
 Program, creating, 104
 Program, interrupting, 117
 Program, running, 106, 153
 Program, running one line at a time, 112
 Program, stopping, 117, 122
 Program, storing, 149
 Programming, 104
 Programs, multiple, 149
 PV, 45

R

R↓, 42, 69, 230
R/S, 106, 117, 122
RCL, 17, 21, 27, 41, 108, 230
REG, 19, 42

RND, 88, 100, 231
 Reciprocal, 100
 registers, 27
 Registers, financial, 41
 Registers, statistics, 93
 Renting versus Buying, 163
 Residual, 209
 Round, 100
 Rounding, 87
 RPN mode, 20, 23, 228
 Running message, 13, 78

S

S, 96, 230
SL, 84, 230
SOYD, 84, 230
STO, 17, 21, 27, 29, 65, 108, 230
SST, 109, 114, 133, 139
 Samples, 96
 Savings, 213
 Scientific notation, 18, 88
 Simple branching, 125
 Simple interest, 42
 Square Root, 100
 Stack, 228
 Standard deviation, 96
 Statistics, 93
 Status indicators, 87
 Storage register arithmetic, 29
 Storage registers, clearing, 29
 Storing numbers, 41
 Storing programs, 149
 Straight-line depreciation, 171
 Sum-of-the-years-digits depreciation, 180

T

Two-variable statistics, 93

U

 20
 Underflow, 90

W

Weighted mean, 99

X

$\overline{X \geq Y}$, 40, 42, 69, 82, 90, 94, 96,
125, 129, 230

$\sqrt{\overline{X}}$, 100, 231

\overline{X} , 94, 230

$\hat{\lambda}, r$, 97, 230

\overline{X}_w , 99, 125, 129

Y

YTM, 13, 82, 83

\hat{y}, r , 97, 230

y^X , 102, 231

\hat{y}, r , 230

Yield, 206, 212