

FULUPET

PET HAIR FORCE DRYER
Instruction Manual

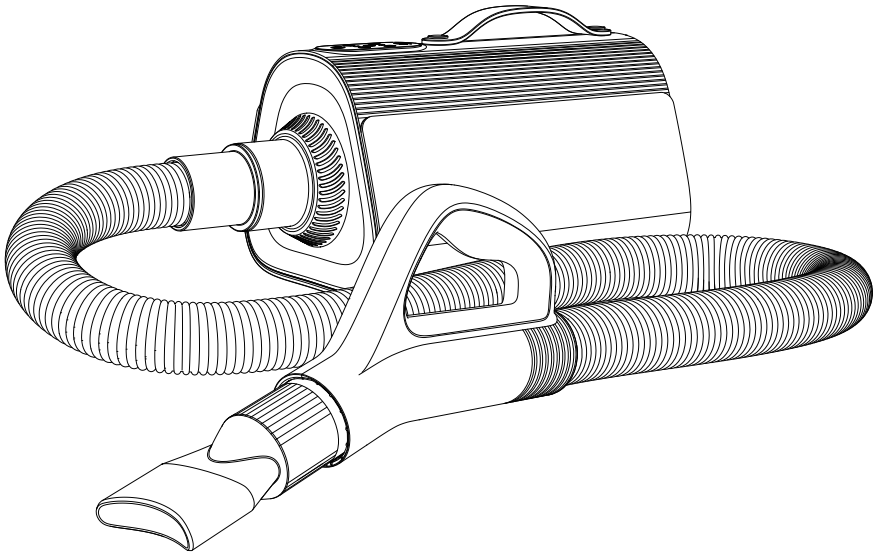

GDF01A

Read Instruction manual carefully before use

CONTENTS

- Safety instructions 01
- Dryer device and accessories 02
- Instructions for use 03
- Product specifications 06

SAFETY INSTRUCTIONS

1. Always use power sockets of reasonable safety standards and capacity (10A or more recommended), and use them separately from other electrical appliances;
2. Do not use this product near textiles or flammable objects, flammable gases (e.g. LPG, volatiles, paint thinners, aerosols, etc.), as this may result in the risk of accidental damage;
3. Do not block the air outlet and air inlet with your fingers or other objects during use. Clean the air outlet after use to avoid the accumulation of grease and other residues;
4. Please clean the air inlet regularly to ensure a smooth air intake, which will extend the life of the hair dryer;
5. Never leave the hair dryer when it is started. After use or when it is switched to a power outage, please turn the speed knob to the minimum, and then pull out the plug from the socket;
6. Avoid dropping the hair dryer or subjecting it to strong impacts;
7. Do not connect any accessories of other brands to this hair dryer to avoid accidents;
8. Please check the condition of the power cable regularly and do not use the hair dryer again if the plug, the power cable or the hair dryer itself is damaged;
9. The hair dryer is not intended for use by physically impaired, unresponsive, children or mentally handicapped persons, unless a guardian is available to supervise and instruct in the use of the hair dryer and can assume responsibility for the safety of the user;
10. Please keep out of reach of Children;
11. Please do not clean this device with diluent, benzene or other lytic agents;
12. Do not disassemble the product yourself when there is malfunction or damage;
15. This dryer used Y connector, if any quality problem, please send back to distributor for repair;
16. If the power cord is damaged, it must be replaced by a professional from the manufacturer, its maintenance department or similar in order to avoid danger.
17. Please unplug the power cord after using it in the bathing room.
18. In order to increase protection, we recommend to install a residual current device(rcd) with rated residual working current not exceeding 30mA in the electrical circuit of bathroom power supply, please consult the RCD installer;
19. This sign on the hair dryer says "Do not use the hair dryer when bathing or showering". Warning: Do not use it near a bath, shower, wash basin, or other utensils that hold water, or with wet hands.
20. If the power cord is damaged, it must be replaced by a professional from the manufacturer, its maintenance department or similar in order to avoid danger.

Dryer device and Accessories

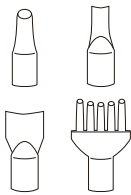
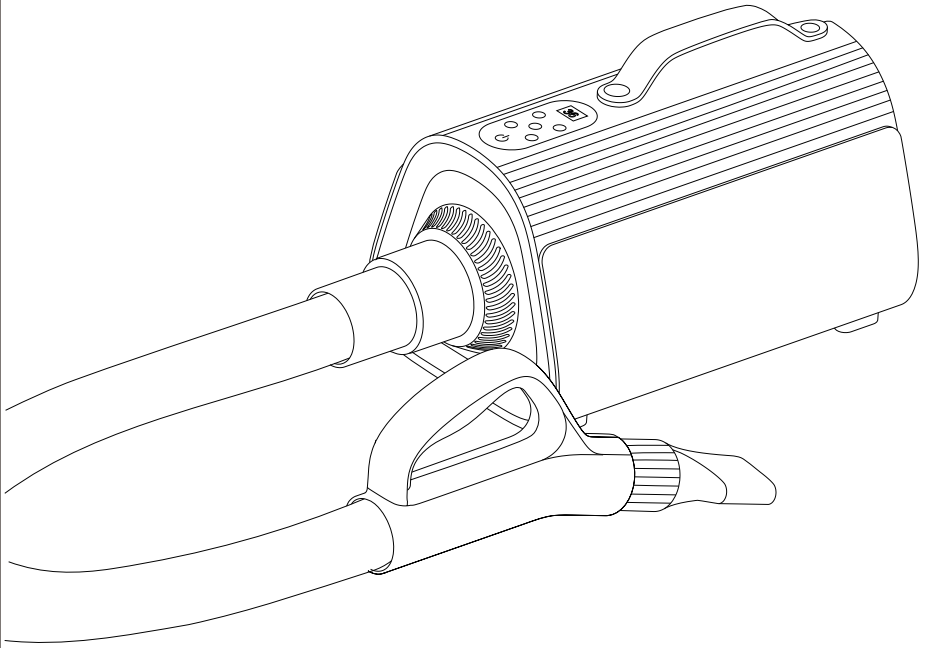

Nozzle*4

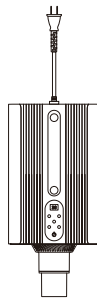

Dryer device

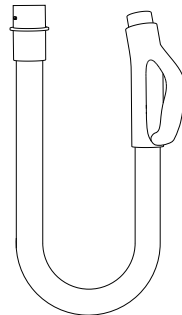

Hose

INSTRUCTIONS FOR USE

Use equipment

1

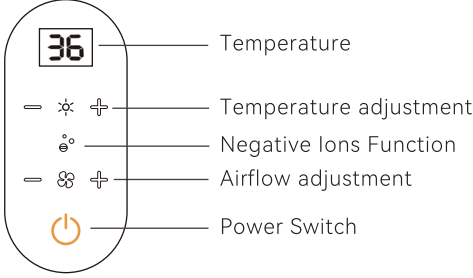

Temperature
Temperature adjustment
Negative Ions Function
Airflow adjustment
Power Switch

INTRODUCTION TO THE CONTROL PANEL

2

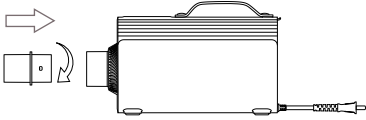

GET STARTED

Insert the soft hose into the air outlet of the device and turn it in clockwise direction to tighten

3

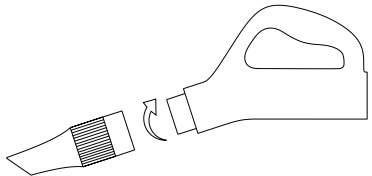

INSTALL THE NOZZLE

Choose a suitable nozzle according to your needs, and rotate it the clockwise direction to install it.

INSTRUCTIONS FOR USE

4

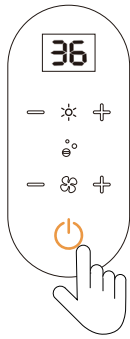

TURN ON THE DEVICE

Insert the plug-in socket, the switch button on the panel will light in orange and flashing, now the machine is in standby state. Then touch the switch button again, it will change to solid orange light and the machine will be started. Touch the negative ion button which is in the middle of the panel, it will light in green, and the negative ion function will be activated.

5

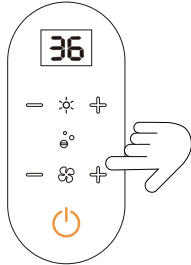

ADJUST THE SPEED

The fan starts automatically after the switch is turned on, the symbol “+” and “-” besides the symbol of the fan will light in solid white, now we can touch these “+” or “-” to adjust the wind speed, the speed will be adjusted in one level after each touch.

Warning: Please hold the handle of blower before adjusting the wind speed to avoid any accident caused by the movement of the soft hose.

6

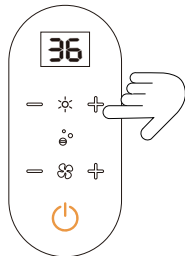

ADJUST FOR TEMPERATURE

Adjust the temperature by touching “+” or “-” beside the temperature symbol, it will be adjusted in 1 °C after each touch.

INSTRUCTIONS FOR USE

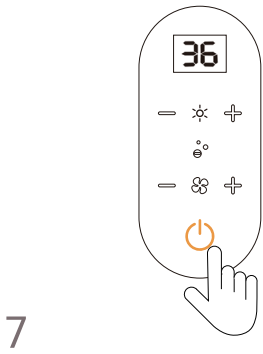

TURN OFF

Please adjust the wind speed to lowest level after use, then touch the switch button to turn off the machine.

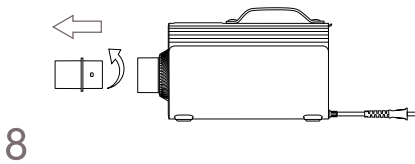

STORAGE

Unplug the socket, remove the hose, and pack up the machine and all accessories.

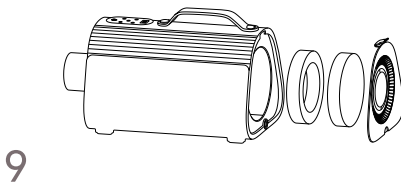

FILTER CLEAN

Remove the cover which is at the back side of machine, then take out the filter and clean it.

PRODUCT SPECIFICATIONS

Voltage	110-120V
Power	1700W
Net weight	3.4kg
Host size	330*180*190mm
Material	ABS/ZMD/PP
Maximum wind speed	75m/s
Product noise	70-83dBA
Negative ion concentration	5×10^7 PCS/cm ³
Temperature regulation range	36°C-60°C
Hose length	0.72-1.5m
Power line length	2m

