

FULUPET

User manual

Pet Grooming Vacuum Cleaner

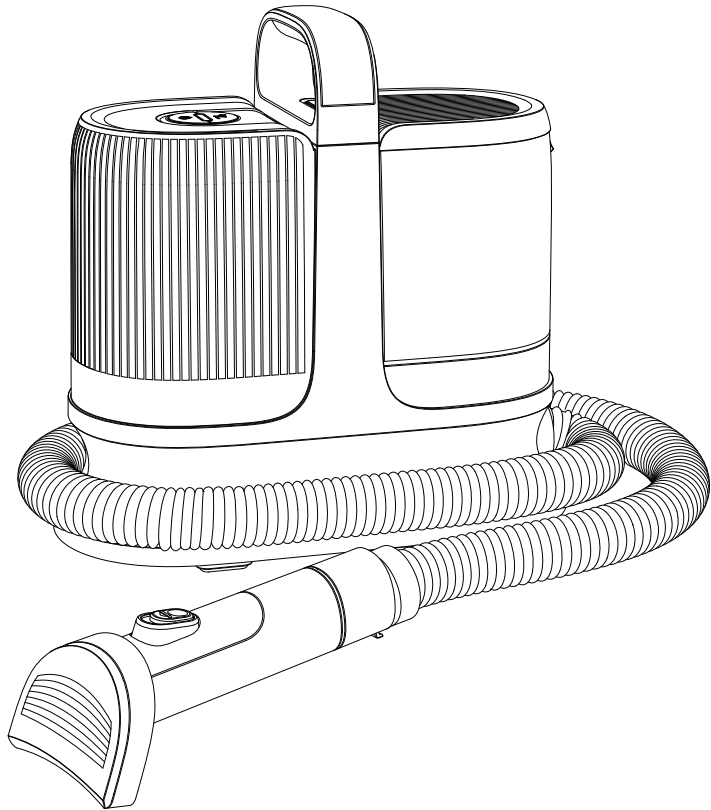

Please follow the steps in this manual to install the machine and keep this manual for further guidance.

CONTENTS

SAFETY GUIDELINE	02
WHAT'S IN THE BOX	04
USE INSTRUCTION	05
CARE AND MAINTENANCE	08
HOSE STORAGE/REMOVAL.....	11
POWER CABLE STORAGE/PRODUCT INFORMATION ...	12

SAFETY GUIDELINE

General Warning

- This product is only for household use, not for commercial or industrial use, not for outdoor or humid places;
- Never let children or people with weak thinking ability use this product alone;
- Use it in a safe environment and under the instructions and supervision of a person who understands the safe use of the product and its hazards;
- Under such circumstances, never let children use it;
- Pay full attention when using it near children and pets. In addition, be careful not to let children and pets play with this product;
- Do not touch the power plug and this product with wet hands, do not absorb moisture and liquid;
- Do not use this product when the power cord or power plug is damaged; In the case of malfunction, damage, or immersed in liquid, be sure to contact customer support;
- Do not disassemble the product, wrong assembly method may cause electric shock or fire, contact customer support when you need repair;
- Do not suck flammable or combustible liquids such as gasoline. Do not use it in an environment with flammable or combustible gas;
- Do not pull the power cord, or put heavy objects on the top of the machine. Do not clamp the wires to a closed door;
- Do not suck anything that is on fire, smoking, or high temperature such as cigarettes, matches, hot soot; Do not block the opening for use;
- Unplug the machine before maintenance;
- Do not use or keep it in humid places such as outdoors or bathroom;
- Do not use products with fragrances as filters. Such chemicals may become one of the causes of fire;
- Use it only with specified voltage, you can find the specified voltage on the bottom of your machine;
- Only use it on dry pets, or it will cause a motor malfunction.

SAFETY GUIDELINE

Cautions

- Do not operate or unplug the power cord with wet hands.
- To avoid malfunction and electric shock, it is absolutely prohibited.
- Do not suck smoke or other highly flammable things.
- Do not use it in places with flammable liquids or combustibles. It may cause fire or explosion.
- There may be peculiar smell when used for the first time. It will not cause adverse effects on the body. When using this product for the first time, there may be an odor but will disappear after a while. Hope your understanding. However, if the burnt smell persists, stop using it immediately.
- Keep the dust cup and filter clean.
- If the dust cup and filter are used dirty, they may be the cause of a malfunction.
- When maintaining, be sure to unplug the power cord before proceeding.
- If the power is turned on for maintenance, there will be a risk of electric shock or injuries.
- The machine shuts itself down when the temperature rises abnormally.
- If abnormal heating of the motor occurs, the operation will be stopped immediately. If the suction port is blocked, the operation will be stopped immediately. To restart it, take out the dust cup, confirm that the suction part and filter are clean, and then turn it on after 30 minutes.
- Be sure to use each filter with the installed state.
- If the machine is turned on with the filter removed, the motor may be damaged.
- Be careful when using to avoid injury.
- For function reason, some of the accessories may include sharp blades or edges, please be careful when using.

WHAT'S IN THE BOX

Vacuum Device/Accessories

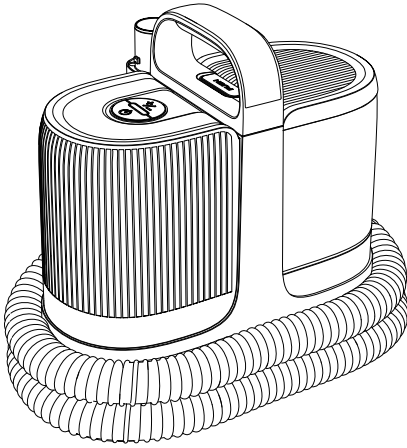

Vacuum Device*1



Nozzle*1



HEPA*1



Wind Cover*1



Clean Brush*1



Sponge Filter*1

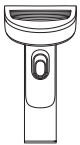

Deshedding Tool*1



Slicker Brush*1

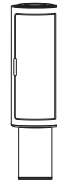

Pet Hair Remover*1



Electric Clipper*1



3mm



6mm



9mm



12mm

Clipping Comb*4

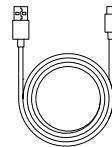

Type-c Usb Charge*1

USE INSTRUCTION

Install the Dust Cup

Put the dust cup in the direction of the arrow.

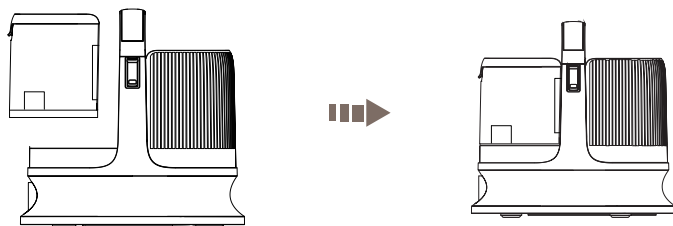

Install for the Accessories

- Connect the Accessory to the Vacuum Cleaner through the Hose.
- When using accessories, please pay attention to the edges of the accessories to avoid scratching your hands.

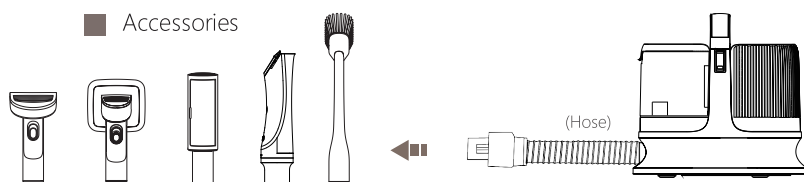

Use for the Electric Clippers

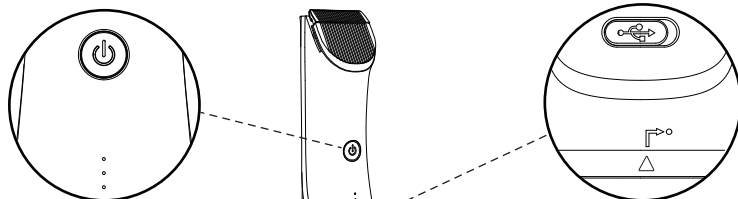

Press and hold the power button for 2s to turn on/off.

Pull off the rubber cover to charge. (3.5 hours charge provides, 2.5 hours of battery life.)

USE INSTRUCTION

Use of Accessories

- ※ Deshedding brush can remove loose hair for long and short coats quickly Reduce shedding by up to 95% of dead and tangled hair.

- 1 ※ Please pay attention to the cutting edge and sharp position when using to avoid injury.
※ The operation should according to the amount of pet hair, to prevent blocking the attachment suction.



- 2 ※ "Slicker brush" can clean the dead and floating hair and debris in the hair and at the same time it had the function of lengthening the hair, making the hair more fluffy.

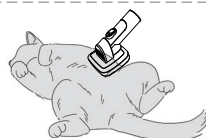

- ※ "Electric Clippers" can shave your pet's hair and suck it into the dust cup to prevent it from falling elsewhere.

- 3 ※ 4 different clipping combs can be used for different demands of hair style (Only for trimming hair purpose)
※ Please pay attention to the cutting edge and sharp position When using to avoid injury.



- 4 ※ "Nozzle/clean brush" can be used for clean the naps of tables, chairs, desks Sofas and keyboard etc.



- ※ "Clipping comb" can be used for different demands of hair styles According to different hair style needs to choose (Optional use);

- 5 ※ The objective are scattered and small, please keep them properly placed when not in use.



- 6 ※ "Roller brush", which is used to clean pet hair on the surface of clothes, sofas and other fabrics;

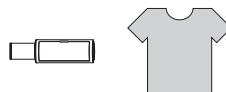

- 7 ※ Adjust the suction mode when there are lot of hair blocking the suction area or just pull the hair out a bit and then suck it again.

USE INSTRUCTION

Use the Device

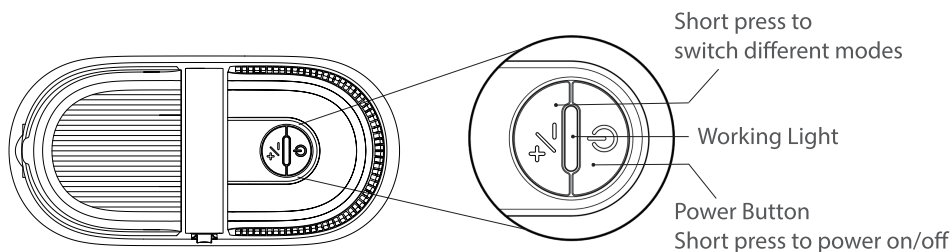

Eco Mode	Standard Mode	Enhanced Mode
	Clean the gaps and corners	Clean the dust and dirt deeply in gaps and corners (Recommended for use)
	Smooth suction Comb the hair (Recommend for use)	Enhance suction Shed the loose hair and tangles
	Air massage Shiny the hair (Recommend for use)	Deep clean Remove dead hair
	Deeply clean (Clean the hairs from pets or from peoples clothes)	Enhance suction (Recommend for use)
	Trimming comfortably (Smooth suction)	

CARE AND MAINTENANCE

Clean the Dust Cup

- Be careful when handling the dust cup.
- If the removed dust cup is cleaned after being dumped with dust, remember to install the dust cup after it is dry to prevent water ingress in the motor and cause electric shock or damage to the machine.

1 Remove the cup

Lift slightly in the arrow direction to remove the cup

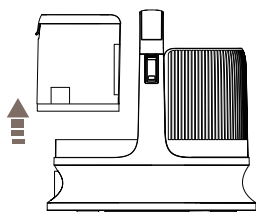

2 Open the lid to dump out trash

Push the buckle to open the dust cup and pour out the dander; then rotate the filter and clean

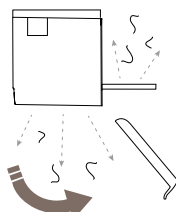

3 Install the dust cup

Install the dust cup in the direction of the arrow

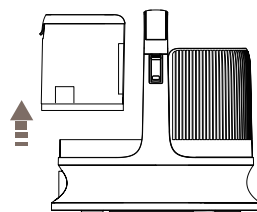

Use for the Electric Clippers

1 Remove the blade



2 Vacuum/clean debris from the clipper and blade

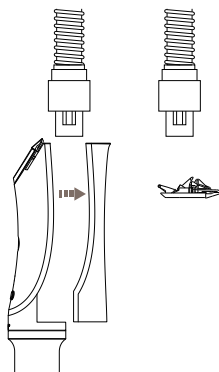

CARE AND MAINTENANCE

Filter (HEPA) Clean

- The filter should be cleaned with cold water at least every other month.
- Please follow the frequency of use and conditions, the maintenance period is also different, regularly confirm if it is dirty, clean it.
- When cleaning, remember to disconnect the power supply and unplug the plug from the socket.

1 Remove the dust cup, take out the filter

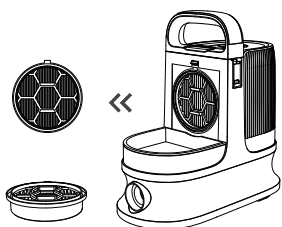

2 Wash with water, drain the water after washing

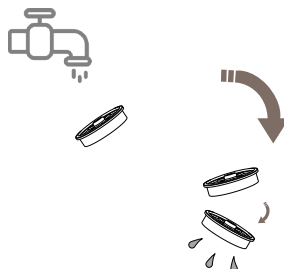

3 Put it in a well-ventilated place for at least 24 hours

- ※ Install the HEPA after it is completely dry;
- ※ It may cause of a malfunction or electric shock.

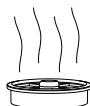

4 Install the HEPA back to the original place after it is completely dry. Please be sure to install it properly.

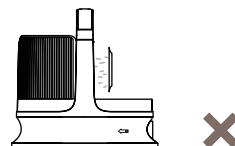
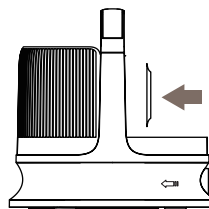

CARE AND MAINTENANCE

Clean the Sponge Filter

- The filter should be cleaned with cold water at least every other month.
- Please follow the frequency of use and conditions, the maintenance period is also different, regularly confirm if it is dirty, clean it.
- When cleaning, remember to disconnect the power supply and unplug the plug from the socket.

1 Remove the dust cup, take out the sponge

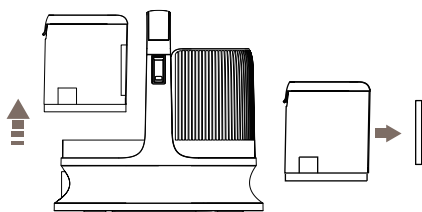

2 Wash with water, drain the water after washing

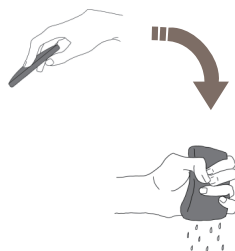

3 Put it in a well-ventilated place for at least 24 hours

- ※ Install the sponge after it is completely dry;
- ※ It may cause of a malfunction or electric shock.

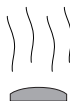

4 Install the Sponge back to the original place after it is completely dry. Please be sure to install it properly.

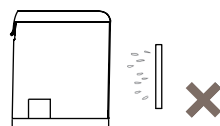
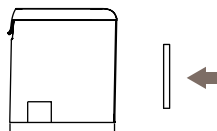

HOSE STORAGE/REMOVAL

Hose Storage Method

Warp the hose clockwise around the device and the hose snaps into the buckle on the side of the device to fix it.

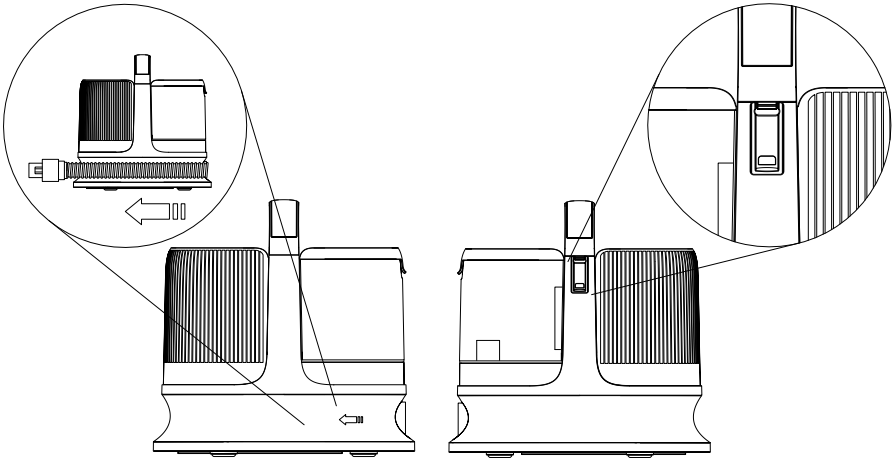

Hose Assembly and Disassembly Method

- Hose assembly: Force straight insertion.
- Hose removal: Right thumb against the fuselage, four fingers against the plug to pull back.

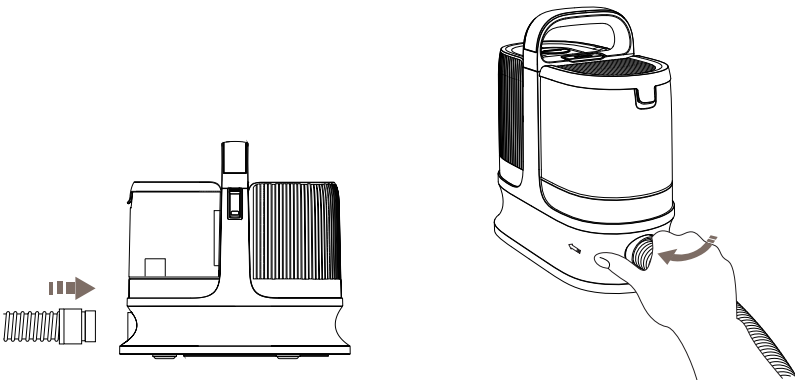

POWER CABLE STORAGE/PRODUCT INFORMATION

Power Cable Storage Mode

Power cable storage: The machine plug wire is wrapped and stored to the bottom of the fuselage, and the plug is placed outside the fuselage.

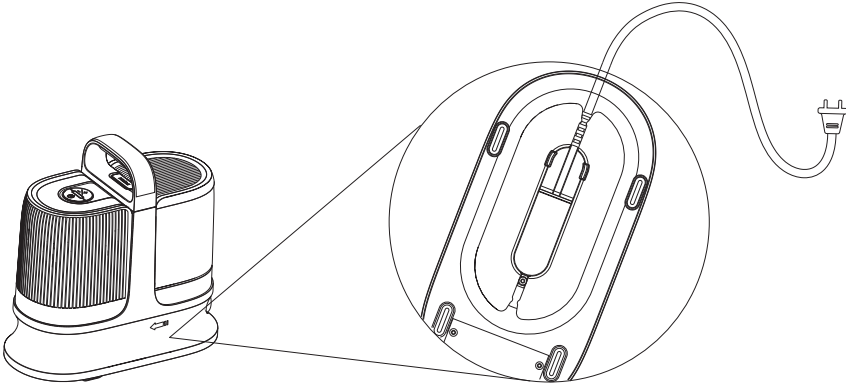

Product Information

Rated Voltage	110 – 120V
Rated Power	400W
N.W.	2.8kg
Product Size	276*133*273mm
Material	ABS/SS/PP
Vacuum Type	Dry
Dust Cup Capacity	1.3L
Wire Length	2.6m
Vacuum Degree	12KPa
Noise	60db (A) at low gear



In response to the national environmental protection regulations, all products are (Smooth suction) made of environmentally friendly materials.

FULUPET

MADE IN CHINA



This device complies with Part 15 of the FCC Rules.

Operation is subject to the following two conditions:

(1) this device may not cause harmful interference, and (2) this device must accept any interference received, including interference that may cause undesired operation.