



Owner's Manual

Impact Series Thermal Scope

TS150, TS250, TS350

DISCOVER THE UNSEEN.

XVISIONOPTICS.COM

- CONTENTS -

| | |
|----------------------------|----|
| Important..... | 1 |
| Welcome..... | 2 |
| FCC Warning..... | 4 |
| Precautions..... | 6 |
| Package Contents..... | 9 |
| About Impact Device..... | 10 |
| Button Descriptions..... | 11 |
| Function Description..... | 14 |
| Icon Descriptions..... | 19 |
| Troubleshooting..... | 20 |
| Storage and Transport..... | 21 |
| Spec Sheet..... | 22 |

- IMPORTANT -

Thank you for choosing this product. Please read this guide before use and keep it for future reference. We hope you'll be satisfied with this product.

This guide is a general guide for a series of products, which means that the specific model you receive may differ from the picture in the guide. Please refer to the actual product you receive.

This user guide is organized for the convenience of users to use and understand our products. We will do our best to ensure the accuracy of the contents of this guide, however, we still cannot guarantee the completeness of the contents thereof. As our products are subject to continuous upgrading, we reserve the right to modify this guide from time to time without prior notice.

- Welcome -

Thank you for purchasing an X-Vision Optics Impact Series Thermal Scope. X-Vision Optics' all-new Thermal Scope (The TS150, TS250, and TS300) redefines hunting. The Impact series thermal scopes provide both day and night use for hunting, scouting, and surveilling. The Impact series thermal scopes have been built to withstand any and all conditions.

The Impact Series Thermal Scopes are multifunctional devices that can be used for both day and night target observation, and in any terrain. The unit has optional hotspot tracking which uses a small crosshair to pinpoint and follow the hottest object in its field of view, making it easy to detect game at long ranges, in dense terrains, and while on the run. Along with this, the scope has a stadia metric rangefinder, giving clarity on exactly how far away the target is. The picture in picture (PIP) feature allows the user to see the multiple views, with a magnification of 2x in an adjustable subset of the screen.

The device has ten reticle options along with six reticle color options. The unit can save six sets of zeroing data, allowing for quick and easy mounting on multiple firearms. This scope is capable of handling over 54 ft/lb. of recoil allowing compatibility with a large variety of firearms. Along with a multitude of included accessories, this thermal scope comes with two interchangeable rechargeable 18650 batteries, giving the user the ability to quickly change out batteries and never miss a shot.

The Thermal Scopes in our Impact Series (TS150, TS250 and TS350) emit their own Wi-Fi signal, which means multiple devices can be connected to the scope at the same time, so no need to rely on cellular data. This allows for a long-range connection giving devices the ability to connect to the scope up to 150 yards away! The scope comes with free applications for both IOS and Android devices, allowing for pictures and videos to be saved on the connected device or on the 32GB of internal memory. The thermal scope is dust and water-resistant to an International Protection Rating of IP67.

- FCC WARNING -

This equipment may generate or use radio frequency energy. Changes or modifications to this equipment may cause harmful interference unless the modifications are expressly approved in the instruction manual. The user could lose the authority to operate this equipment if an unauthorized change or modification is made.

This device complies with part 15 of the FCC Rules. Operation is subject to the following two conditions: (1) This device may not cause harmful interference, and (2) this device must accept any interference received, including interference that may cause undesired operation.

The device has been evaluated to meet general RF exposure requirement. The device can be used in portable exposure condition without restriction.

NOTE: This equipment has been tested and found to comply with the limits for a Class B digital device, pursuant to part 15 of the FCC Rules. These limits are designed to provide reasonable protection against harmful interference in a residential installation. This equipment generates, uses and can radiate radio frequency energy and, if not installed and used in accordance with the instructions, may cause harmful interference to radio communications. However, there is no guarantee that interference will not occur in a particular installation. If this equipment does cause harmful

interference to radio or television reception, which can be determined by turning the equipment off and on, the user is encouraged to try to correct the interference by one or more of the following measures:

- Reorient or relocate the receiving antenna.
- Increase the separation between the equipment and receiver.
- Connect the equipment into an outlet on a circuit different from that to which the receiver is connected.
- Consult the dealer or an experienced radio/TV technician for help.
- The rating information is located at the bottom of the unit.

- PRECAUTIONS -

DANGER

- 1) Please charge the battery with the method described in this Guide and follow the charging procedure and precautions. Improper battery charging can cause heating, damage and even physical injury.
- 2) Do not open or disassemble the battery. If the battery leaks, do not touch the leaked fluid. If the leaked fluid gets in your eyes, rinse them immediately with clean water for at least 15 minutes and seek medical attention.

WARNING

- Try to keep equipment stable and avoid violent shaking when in use to avoid damage.
- Do not use or store the device in an environment that exceeds the allowable operating temperature or storage temperature.
- Do not directly aim the device at high-intensity thermal radiation sources, such as the sun, lasers, spot welding machines, etc.
- Do not plug the device ports.

- Do not disassemble the machine by yourself. This may cause equipment damage and loss of warranty rights.
- Do not use soluble liquids on equipment and cables. This may cause damage to the equipment.
- Please do not use in environments that exceed the operating temperature of the device. This may cause damage to the equipment.
- Please observe the following measures when cleaning this device:
 - Non-optical surface: Use clean and soft cloth to wipe the non-optical surface of the thermographic camera.
 - Optical surface: When using the thermographic camera, please avoid polluting the optical surface of the lens. Avoid touching the lens with your hands, because the sweat on your hands will leave traces on the lens glass and may corrode the optical coating on the glass surface. When the surface of the optical lens is polluted, use a microfiber cloth to wipe it carefully.

- Do not place the battery in a high temperature or near a high-temperature object.
- Do not short circuit the positive and negative poles of the battery.
- Do not expose the battery to moisture or water.

 **NOTES:**

- 1) Do not expose the equipment to dust or moisture. Avoid water splashing on the equipment when being used in a wet environment. Cover the lens when not using the camera.
- 2) Please put the device and all accessories in the case when not in use.

- PACKAGE CONTENTS -

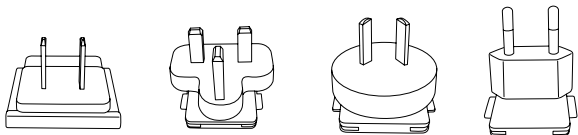

Plug of American, British, Australian, or European standard

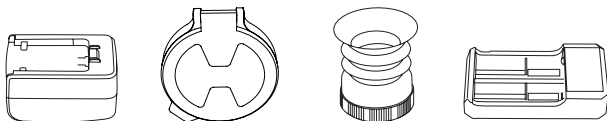

5V2A adapter

Lens cover

Eye mask

Charger

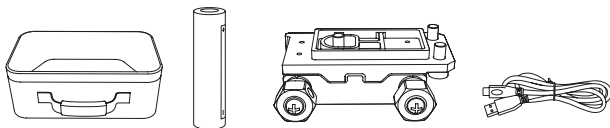

Carrying case

18650 Battery

Sight base

Type-C cable

- ABOUT IMPACT SERIES -

This Guide is applicable to many models of this series, but only one model is shown in the figure.

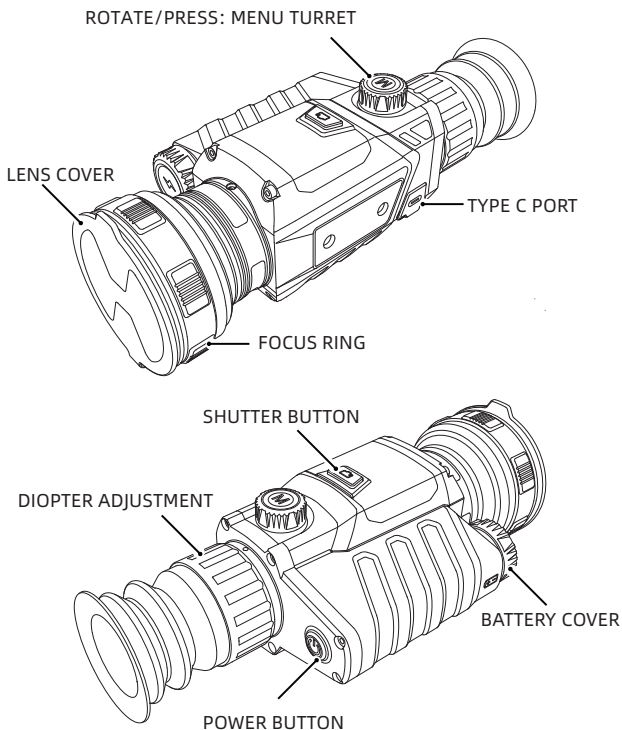

- BUTTON DESCRIPTION -

| Buttons | Current device status | Short press | Long press |
|---------------------|---|--------------------|--|
| Power on/off button | Power on (any interface) | Compensation | Display off/ Power off |
| | Power off | / | Power on |
| | Display off | Display on | Display on |
| | Power on (Video recording) | Compensation | Save the video and power off |
| Menu turret | Power on and the menu is not called out | Zoom in/out | Quick zoom in/out |
| | Power on and the menu is called out | Menu switch | Quick menu switch |
| Menu button | Power on and the menu is not called out | Shortcut menu | Main menu |
| | Power on and the menu is called out | Select and confirm | Return to the previous menu without saving |
| Shutter button | Power on and the menu is not called out | Photo | Video |
| | Video recording | Photo | End video recording |
| | Power on and the menu is called out | / | / |

BUTTON DESCRIPTION

1. POWER BUTTON

POWER ON:

Long-press the Power button until the boot screen appears in the eyepiece, indicating the device is turned on successfully.

POWER OFF:

- a. Manual power-off: Long-press the Power button to display the shutdown progress bar and hold until the shutdown is successful.
- b. Automatic power-off: If there is no button operation within the set automatic shutdown time, it will power off.

DISPLAY OFF:

Long-press the Power button to display the shutdown progress bar. Before the progress bar is completed, release the Power button to cancel the shutdown and enter the Display off mode.

DISPLAY ON:

In Display off mode, press any button to wake up the screen.

2. MENU TURRET:

ZOOM-IN:

When the device is turned on and the menu is not

called out, rotate the menu turret clockwise to zoom in on the image.

ZOOM-OUT:

When the device is turned on and the menu is not called out, rotate the menu turret counterclockwise to zoom out from the image.

MENU NAVIGATION:

When the device is turned on and the menu is called up, rotate the menu turret clockwise to navigate the menu or options down/right. Rotate the menu turret counterclockwise to move the menu or options up/left.

5. MENU BUTTON

SHORTCUT MENU:

When the device is turned on and the menu is not called up, short-press the Menu turret to display the shortcut menu.

MAIN MENU:

When the menu is not called up, long-press the Menu turret to display the main menu.

OK AND BACK/EXIT:

When the menu is called up, short-press the Menu button to confirm the current selection. Long-press the Menu button to return or exit the menu without saving the current selection.

6. SHUTTER BUTTON

PHOTO:

When the device is turned on and the menu is not called up, short-press the Shutter button to take a photo. The photo will display for 300ms before returning to the real-time screen.

VIDEO:

Long-press the Shutter button to start recording, and long-press again to finish the recording.

FUNCTION DESCRIPTION

1. SHORTCUT MENU

- Picture in Picture (PIP): 2X amplification within 256px × 192px. There are three positions to choose from: upper left, upper middle and upper right.
- Screen brightness: The screen brightness can be adjusted from level 1 to 10.
- Hotspot tracking: A cursor appears on the display, highlighting the point with the largest AD value in the visible range.
- Super power saving: When super power saving mode is enabled, the ARM switches to the low power mode.

The OLED brightness control, WiFi, and transmitting record function will be disabled in this mode. Display brightness is fixed at 20%.

- Rough ranging: The position of the lower horizontal line remains unchanged, and the upper horizontal line can be moved. The minimum distance between the two horizontal lines is 6px, and the upper horizontal line shall not exceed the UI prompt position.
- Zero calibration distance: You can quickly select the zero calibration settings saved for different zero calibration distances (50m/100m/200m/300m/500m).

2. MAIN MENU

- Pseudo color mode: Pseudo color mode can be set in White hot, Black hot, Adjustable red hot, Iron red, Blue hot, or Green hot.
- Brightness: The display brightness can be adjusted from level 1 to 10.
- Contrast: The display contrast can be adjusted from level 1 to 10.
- Personal settings of zero calibration: 10 sets personal setting parameters can be saved, including the zero calibration distance, zero calibration position, reticle type, reticle color and reticle brightness.

- Reticle type: There are ten reticle types to select from.
- Reticle color: The reticle colors can be Black, White, Yellow, Green, Blue, or Red.
- Reticle brightness: The reticle brightness can be adjusted from level 1 to 10.
- WiFi: When the device is connected to the mobile client, you can transmit real-time videos, access media files, and control the device remotely through the app.

- Download the "TargetIR" app.





























(Available on iOS and Android).

- Connect the phone to the device WiFi network (Binocular-TI-xxxx) and enter the password "12345678".
- Open the app to view and operate remotely
- Record mode: There are three modes to be selected: Single shot, Shooting while transmitting, and Transmitting record.
- Watermark Settings: Options can be made from Off/ Date only/Time only/Time and date.
- Auto sleep: Auto sleep time can be set at 5/10/15min. If no operation is made within the set time, the camera will enter the sleep mode.

- Automatic power off: Automatic power off time can be set at 15/30/60min. If no operation is made within the set time, a power-off countdown will appear and the camera will shut down when it is complete.
- Time format: The time format can be 12H or 24H.
- Date format: The date format can be YYYY-MM-DD or MM-DD-YYYY or DD-MM-YYYY.
- Time settings: Enter the time adjustment interface and rotate the Menu turret to navigate the options. Short-press the Menu turret to select the next adjustment item and rotate the Menu turret to set the time.
- Language settings: Language can be selected in English, Russian, German, French, Chinese, Spanish, Italian, Japanese, and Korean.
- Memory card formatting: Memory card formatting can be selected. Select "Yes" to format the memory card and select "No" to cancel the operation.
- Restore default: Users can restore the default settings for their device. Select 'Yes' to restore all parameters to factory settings, or 'No' to cancel the operation.

- About: You can view the current APP, ARM, MCU, FPGA version and MAC address of the device.
- External ranging (cursor): The external ranging cursor switch can be controlled.
- Remote control: When Remote control is on, it will search and connect to the Bluetooth remote control. Once the connection is successful, you can use the Bluetooth remote control to control all functions of the device (except the long-press function).
- Ranging calibration: The default image magnification factor is 1X when entering the ranging coordinates adjustment interface. The X-axis/Y-axis can be adjusted by rotating the Menu turret.

- ICON DESCRIPTION -

| Icon | Meaning | Icon | Meaning |
|---|-------------------------------------|---|--------------------------------|
|  | Photo taking successfully |  | Video recording while shooting |
|  | Video recording successfully |  | Memory card full |
|  | Photo taking failure |  | Memory card is to be full |
|  | Video recording failure |  | Super power saving mode |
|  | WIFI |  | External power |
|  | Bluetooth |  | Battery low |
|  | Do not take photos |  | Low capacity |
|  | Do not record videos |  | Medium low capacity |
|  | No record mode |  | Medium capacity |
|  | Do not adjust the screen brightness |  | Medium high capacity |
|  | Do not turn on WIFI |  | High capacity |
|  | Do not turn on serial port mode |  | Serial port mode |
|  | Take photos while shooting |  | USB flash disk |

- TROUBLESHOOTING -

1. Device fails to start.

Solution: Replace the cell or connect the adapter for charging.

2. The device cannot take photos/record.

Solution: the internal storage space of the device is full. Format the memory card or offload media to resolve.

3. The device display time does not match the actual time display.

Solution: Reset the time and date in the device settings menu.

4. Screen goes out during use.

Solution: Short-press any button to wake up the device from hibernation mode.

5. The image of the device is blurred during use.

Solution: turn the diopter adjustment to focus manually until the display is clear.

- STORAGE AND TRANSPORT -

The following is the correct storage and transportation of the product. To prevent danger, property loss, etc., please read the manual carefully before using the device. Strictly observe it, and keep the instruction properly after reading it.

Storage:

1. The device should be stored in a well-ventilated, clean, condensation-free and corrosive gas-free room with temperature of -22F ~ 140F, and relative humidity not exceeding 95%.
2. Please charge the device once every 3 months to prevent deterioration.

Transport:

During transport, the device should be protected against water, falling, and any severe vibration or impact. Handle with care

| | Impact | | |
|---------------------------------|---|--------------------------|--------------------------|
| | TS350 | TS250 | TS150 |
| Magnification | 2 to 16x | 4.7 to 18.8x | 2.4 to 9.6x |
| Thermal Sensor | 640 x 480 | 384 x 288 | |
| Pixel Size | 12 μ m | | |
| Frame Rate | 50 Hz | | |
| Objective Lens | 35mm | 50mm | 25mm |
| Field of View | 70ft @ 100yd | 60ft @ 100yd | |
| Detection Range | 1,500yd | 2,200yd | 1,100yd |
| Recognition Range | 500yd | 725yd | 475yd |
| Hotspot Tracking | YES | | |
| Rangefinding | YES | | |
| Picture in Picture | YES | | |
| NETD | \leq 30 mk | | |
| Temperature Variation Detection | 0.05° F | | |
| Display Resolution | 1024 x 768 OLED | | |
| Reticle | 10 Patterns and 6 Color Options | | |
| Color Palettes | 6 | | |
| Power Supply | Rechargeable 3.6v Lithium-Ion (1 incl.) | | |
| Battery Life | 8 Hours | | |
| IP Rating | IP67 | | |
| Dimensions | 8.19" x 3.46" x 2.59" | 8.62" x 3.46" x 2.59" | 7.95" x 3.46" x 2.59" |
| Weight | 1.2 Pounds | 1.3 Pounds | 1.2 Pounds |
| Internal Memory | 32GB | | |
| Mount | Picatinny | | |
| Wi-Fi Capability | YES | | |
| Photo and Video | YES | | |
| Applications | YES | | |
| Accessories | Dual Battery Charger, Charger Cable, Short Sight Base, Lens Cloth, Rubber Eye Pieces, Lens Cap, 1 Battery | | |



Contact Us

5140 Moundview Drive
Red Wing, MN 55066 USA

(833) 993-2383 (US)
(651) 385-2276 (Canada)
support@xvisionoptics.com

DISCOVER THE UNSEEN.

XVISIONOPTICS.COM