

# INFINITY<sup>®</sup>

## MASSAGE CHAIR



# INFINITY<sup>®</sup>

72 Stard Road, Seabrook, NH 03874  
603-910-5000  
[www.infinitymassagechairs.com](http://www.infinitymassagechairs.com)

User Manual

CELEBRITY

Thank you for purchasing your Celebrity massage chair from Infinity. Before use, please read this USER MANUAL carefully, and pay special attention to the safety precautions to ensure proper operation and use.

Please keep this USER MANUAL for future reference.

## ▶ CONTENTS

---

|   |    |
|---|----|
| SAFETY PRECAUTIONS .....                  | 1  |
| NAME AND FUNCTION OF EACH COMPONENT ..... | 3  |
| External structure .....                  | 3  |
| Internal structure .....                  | 3  |
| Power box .....                           | 4  |
| Controller .....                          | 5  |
| Controller buttons .....                  | 6  |
| LCD screen icon descriptions .....        | 8  |
| FUNCTIONS AND FEATURES .....              | 10 |
| PRECAUTION BEFORE USING .....             | 11 |
| Installation Method .....                 | 11 |
| Move method .....                         | 15 |
| Turn on power supply .....                | 15 |
| Installation position .....               | 16 |
| Floor protection .....                    | 16 |
| First use of massage chair .....          | 17 |
| Before sitting in the chair .....         | 17 |
| After using .....                         | 18 |
| Surrounding environment .....             | 18 |
| Grounding .....                           | 18 |
| PRODUCT STORAGE AND MAINTENANCE .....     | 19 |
| TROUBLE SHOOTING .....                    | 20 |
| TECHNICAL SPECIFICATION .....             | 21 |

## ▶ TECHNICAL SPECIFICATIONS

---

Name: Deluxe Multi-Functional Massage Chair

Model: Celebrity

Rated voltage: 110-120V~

Rated frequency: 60 Hz

Rated current: 1A

Safety design: Class I

## ▶ TROUBLE SHOOTING

| No. | Problem  | Possible Cause  | Solution   |
|-----|--|---|--|
| 1   | You hear a rubbing or a knocking sound.                            | This is a normal sound made by the motor or produced when the massage ball is rubbed against the cloth cover. | It is normal. There is no need for treatment.      |
| 2   | The machine can not start up.                                      | The power plug is detached from the wall socket.  | Insert the power plug into the socket again.       |
|     |  | The power switch is not turned on.  | Turn on the switch.                                |
|     |  | The fuse of massage chair blew out.   | Replace the fuse with a new one of the same model. |
| 3   | The airbag installed in the seat cushion or legrest does not work. | Check whether there is a blockage in the air tube.  | Clear the air tube                                 |





If the chair still does not operate normally after the above measures have been taken, please contact a local distributor for repair and maintenance.

**Note:** Do not dismantle the product by yourself. Our company shall shoulder no responsibility for the damage to the product or injury of people caused by improper use! Thanks for your cooperation.



## ▶ SAFETY PRECAUTIONS

### Safety Precautions

- ▶ Before using, please read SAFETY PRECAUTIONS carefully to ensure proper operation.
- ▶ The following SAFETY PRECAUTIONS will help you operate this massage chair correctly.
- ▶ To clearly indicate the degree of danger and damage, the type of accidents caused by incorrect use are classified into “WARNING” and “CAUTION.” Instructions marked as follows should be strictly adhered to:



|   |                    |  |
|---|--------------------|--|
|  | <b>WARNING</b>     | Improper operation may cause injury to user.   |
|  | <b>CAUTION</b>     | Improper operation may cause user injury or product damage.  |
|  | <b>Forbidden.</b>  | Specific instruction will be indicated in the diagram drawings.(E.g, the left drawings means disassembly is not allowed.)  |
|  | <b>Compulsory.</b> | Specific instruction will be indicated in the diagram drawings.(e.g, the left drawings means to disconnect the power plug) |

### **WARNING**

|   |   |
|---|---|
| <br>COMPULSARY       | <p>We recommend that those with any of the following conditions should consult a doctor before using:</p> <ol style="list-style-type: none"> <li>1. Those with an electronic medical instrument imbedded in the body, such as a cardiac pacemaker.</li> <li>2. Those being treated by doctors, especially those experiencing pain.</li> <li>3. Those suffering from cancer, heart disease or other serious illnesses.</li> <li>4. Women who are pregnant.</li> <li>5. Those with osteoporosis or spinal injuries.</li> <li>6. Those with skin diseases or open wounds .</li> <li>7. Those whose body temperature is over 100 degrees Fahrenheit.</li> </ol> |
| <br>PROHIBITED     | Do not allow disabled persons to use the chair unattended. (Supervised use is OK).  |
|   | Do not allow children play on massage chair.  |
|   | Do not allow more than one person to use this massage chair at a time.  |
|   | If the power cord or power plug becomes damaged in any way, turn the chair OFF and disconnect the plug from the wall socket immediately. Consult an authorized service engineer for repair or replacement.  |
|   | Do not damage, excessively bend, pull twist or knot the power cord.   |
| <br>NO DISASSEMBLY | Children are not allowed to use this product.   |
|   | Anyone else, except maintenance personnel specified by our company, should not disassemble, maintain, or remodel this massage chair. If you experience any problems, please contact a local dealer immediately.   |

## SAFETY PRECAUTIONS

### CAUTION

|  |  |
|--|--|
| <br>COMPULSARY    | <ul style="list-style-type: none"> <li>◆ Please do not continuously use the massage chair for more than 20 minutes. Limit massage to a particular part of body to 5 minutes.</li> <li>◆ Please put the massage chair on flat ground during use.</li> <li>◆ When adjusting the legrest or backrest, please do not exert excessive force on it. Keep children and pets well clear.</li> <li>◆ When removing the power plug, please hold the insulated plug. Do not pull the power cord.</li> <li>◆ Please do not use a power source that is beyond the specified electric voltage, as this may cause fire or damage massage chair.</li> <li>◆ Before using, please uncover the back cushion to check whether the backrest or fabric is damaged. If damaged, please stop using this massage chair immediately, and contact the local distributor for repair.</li> <li>◆ Please do not operate the controller with damp hands, and do not put heavy objects on the controller.</li> <li>◆ The maximum weight capacity for the massage chair is 300 pounds.</li> <li>◆ Please do not use other therapeutic equipment while using this massage chair.</li> <li>◆ If you feel uncomfortable, please stop using the chair immediately and consult your doctor.</li> <li>◆ This massage chair is designed and intended for non commercial household use only. Do not use the massage chair for medical treatment.</li> <li>◆ The massage chair is equipped with a heating function. Please use with caution .</li> <li>◆ Always switch off power and remove the plug from the wall socket immediately after use and before cleaning.</li> </ul> |
| <br>PROHIBITED  | <ul style="list-style-type: none"> <li>◆ To avoid causing discomfort, do not use the massage chair immediately after meals.</li> <li>◆ Do not fall asleep in the massage chair while it is operating.</li> <li>◆ Do not use the massage chair if you are intoxicated or ill.</li> <li>◆ If the upholstery becomes dirty, use only good quality leather cleaner. Do not use chemical cleaners, petrol or detergents.</li> <li>◆ To avoid accidental injury or machine damage, do not sit on backrest, legrest or armrest.</li> <li>◆ Please do not smoke while using the massage chair.</li> </ul>  |
| <br>REMOVE PLUG | <ul style="list-style-type: none"> <li>◆ Before performing maintenance, please remove the power plug. To avoid electric shock, please do not insert or pull out the plug with damp hands.</li> <li>◆ When the massage chair is not in use, please switch off power and remove the plug from the wall socket.</li> </ul>  |

## PRODUCT STORAGE AND MAINTENANCE

### Maintenance

- ▶ Use a damp cotton cloth with mild soap to wipe the back cover, hand rest, legrest, air tube and other plastic components. Then wipe with a dry cotton cloth.
- ▶ Use a dry cloth to wipe the controller, DVD, and power supply box.
- ▶ Use a damp cotton cloth with mild soap to wipe the back cushion and pillow, wipe again with a different damp cloth. Put them to a well-ventilated place to dry.

#### Caution

- ▶ Make sure to unplug before beginning maintenance. To avoid electric shock, do not use wet hands to pull out the plug. When cleaning the back cover, please do not allow soap or water to enter into the power supply box!
- ▶ Do not iron the upholstery.

### Storage method

- ▶ Wipe off dust and dirt from the product after use. If the product is not to be used for a long period of time, please cover the product with a dust cover (self provided).

#### Caution

- ▶ Do not store the product in direct sunlight or in places of high temperature. This may cause the color of the upholstery to fade.

### Reminder

During daily use, please check for the following issues:

- ▶ A scorched or burning odor
- ▶ Power flickering on and off if power cord is touched
- ▶ Extremely hot power cord
- ▶ Other abnormal indicators

#### Caution

- ▶ To avoid breakdowns and accidents, please stop using the massage chair if any above warning signs occur.
- ▶ Turn off the power switch and pull out the power plug. Contact the local distributor or headquarters for repair and maintenance.
- ▶ All repairs and maintenance can only be performed by our authorized dealers or service agents, except for the normal operation and maintenance detailed above.

## PREPARATION BEFORE USING

### After using

- ▶ Please power off the chair and unplug the power cord from the wall socket after using the chair.
- ▶ Please store the chair if it is not in use for a long time.

### Surrounding environment



Keep the massage chair away from damp places (for example: bathroom) to avoid electric leakage.



Keep the massage chair away from high temperature sources (for example: stove) to avoid fire or damage to leather material.

### Grounding instruction

This product must be grounded. If it should malfunction or breakdown, grounding provides a path of least resistance for electric current to reduce the risk of electric shock. This product is equipped with an equipment-grounding conductor and a grounding plug. The plug must be plugged into an appropriate outlet that is properly installed and grounded in accordance with all local codes and ordinances.

**DANGER** Improper connection of the equipment-grounding conductor can result in a risk of electric shock. Check with a qualified electrician or serviceman if you are in doubt as to whether the product is properly grounded. Do not modify the plug provided with the product if it will not fit the outlet, have a proper outlet installed by a qualified electrician.

This product is for use on a nominal 120-volt circuit and has a grounding plug that looks like the plug illustrated in sketch A in following figure. Make sure that the product is connected to an outlet having the same configuration as the plug. No adapter should be used with this product.

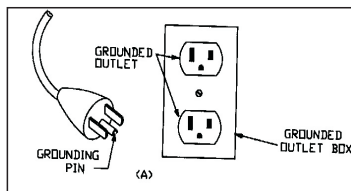

### Grounding

- ▶ This massage chair is a Level One electrical appliance, make sure to use three-core power supply socket and to guarantee the ground wire connected to the power supply socket has obtained good ground connection to avoid electric leakage, electric shock and some other negative effect during use.

## NAME AND FUNCTION OF EACH COMPONENT

### External structure

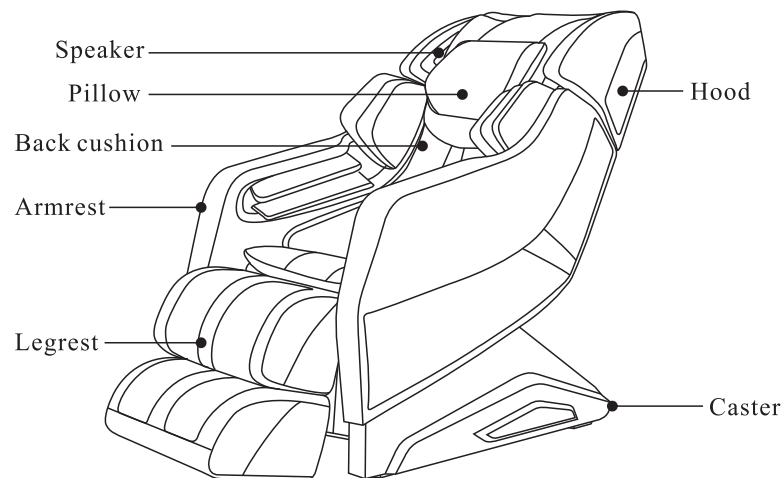

### Internal structure

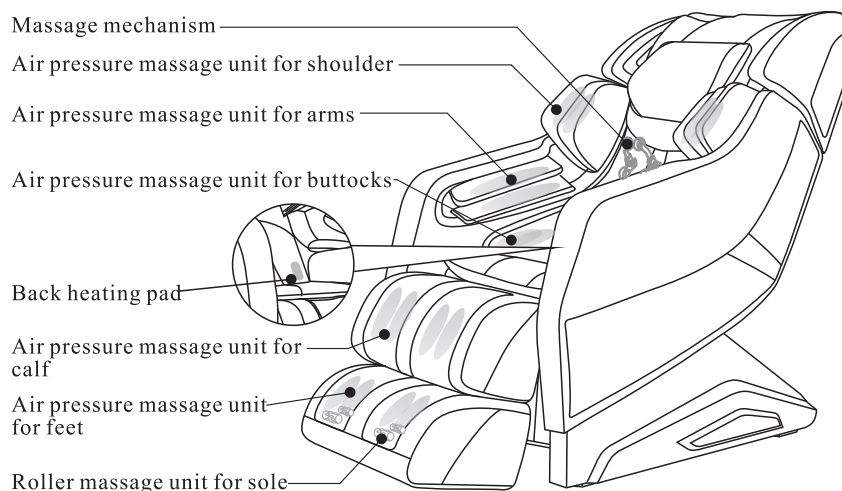

## ▶ NAME AND FUNCTION OF EACH COMPONENT

### Power box

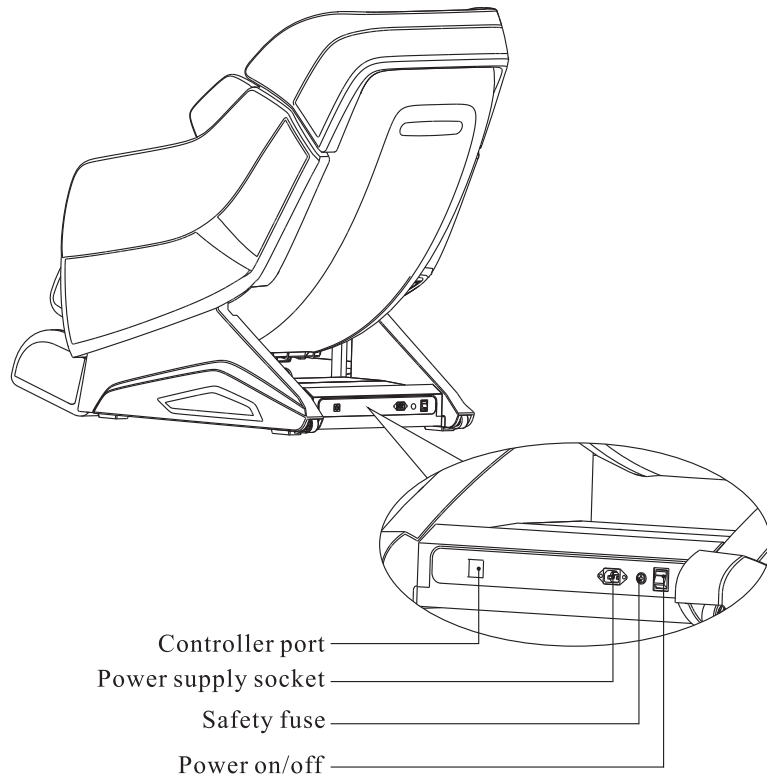

#### ⚠ Caution

- ▶ To avoid accidents involving the power supply box, do not let children play on the chair.
- ▶ Please power off and unplug the chair from the wallsocket after the massage finishes.
- ▶ Do not use the chair during thunderstorms or severe weather.
- ▶ Please power off and unplug the chair from the wallsocket when the chair is not in use, so that children won't accidentally turn on the chair.
- ▶ Please store the chair if it is not in use for a long time.

## ▶ PREPARATION BEFORE USING

### First use of massage chair

- ▶ Before first use, please make sure there is enough space around the chair. Use the controller to recline the backrest to the lowest position, raise the legrest to the highest position and stretch out the chair to its maximum length.
- ▶ Test that all functions work normally, then power off the chair. Return back to original position.

(To select the program, please refer to "Controller instruction" and "Display screen menu instruction.")

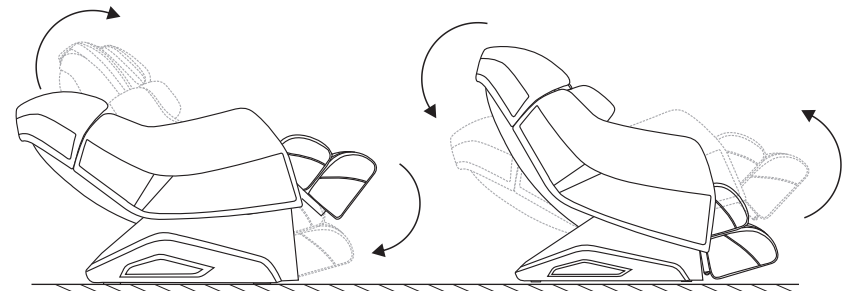

#### ⚠ Caution

- ▶ Do not put fingers or any other objects into the gap between the seat and legrest.
- ▶ When adjusting up and down angles of the backrest and legrest, please make sure there is no obstacle around the massage chair.
- ▶ During using, please make sure the power cord is not entangled or clamped but laid orderly.

### Before sitting in the chair

- ▶ Make sure the legrest is working properly.
- ▶ Make sure the chair is in the original, upright position. If any part is not in the original position, please power on/off again to make the chair go back to the original position.

#### ⚠ Caution

- ▶ Do not climb into the chair if the legrest is raised. Return the legrest to the closed position, sit down in the chair, then raise the legrest while seated in the chair.
- ▶ Do not sit on, or put heavy objects on the legrest. This may damage the legrest mechanism.

## ▶ PREPARATION BEFORE USING

### Installation position

Safety distance for the periphery of massage chair.

- ▶ Please make sure there is adequate space for installation of this product:  
Back: minimum 24 inches from the wall or any other obstacles  
Front: minimum 12 inches from any obstacles
- ▶ In order to prevent signal interference, please keep at least 3 feet away from the TV, radio or other video and audio devices.

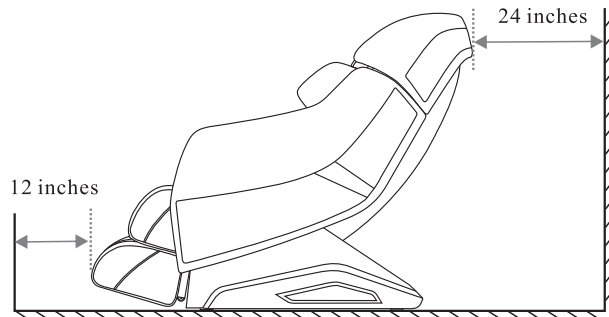

### Floor protection

- ▶ In order to prevent damage to the floor, please put carpet or other padding under the massage chair.

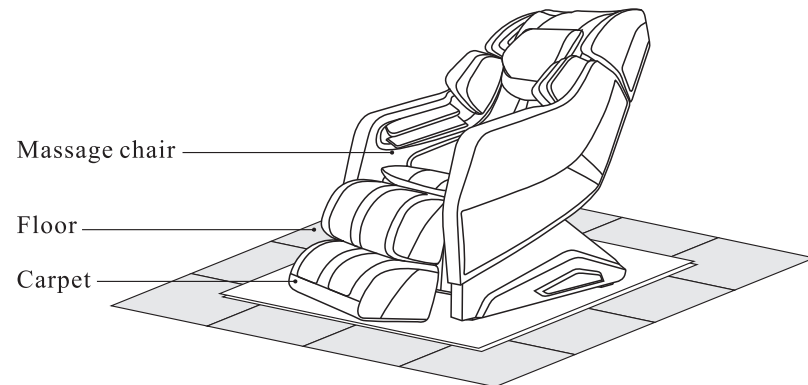

## ▶ NAME AND FUNCTION OF EACH COMPONENT

### Controller

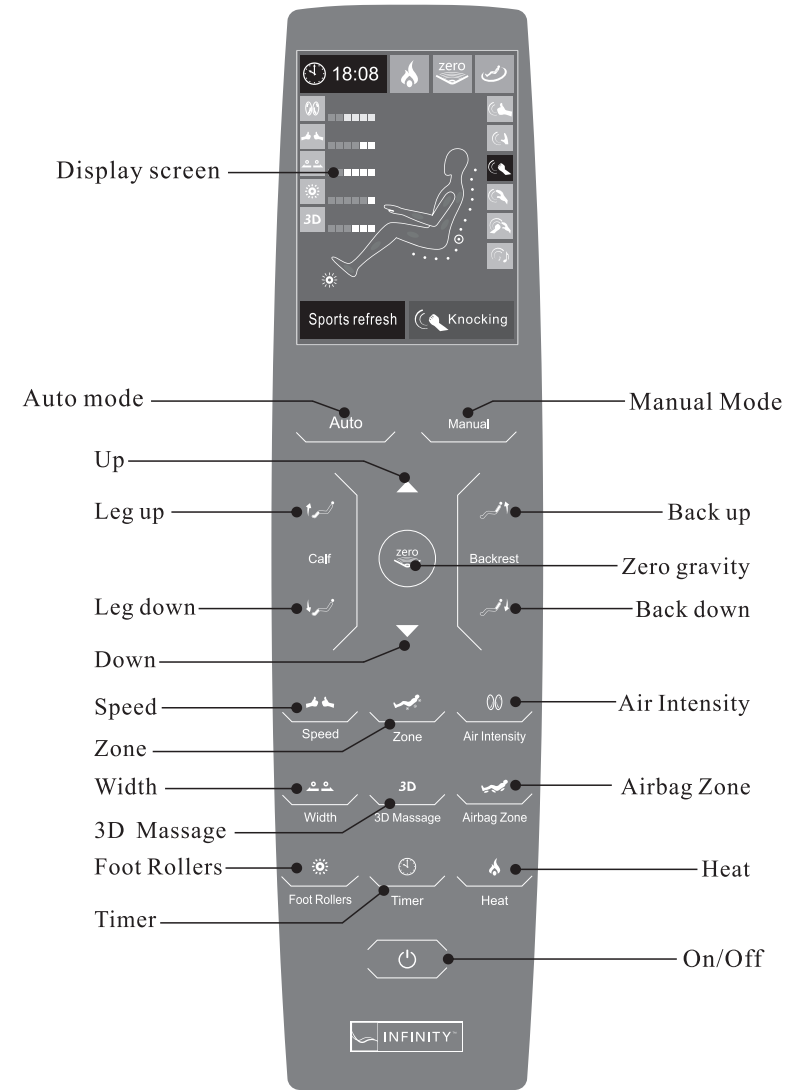

## ▶ NAME AND FUNCTION OF EACH COMPONENT

### Controller Buttons



#### On/Off

- ▶ When chair power is turned on, click this button to turn on the controls.  
Click this button again to turn off all functions.

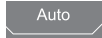

#### Auto programs

When the massage chair is working, press the auto button to select an auto massage. You can choose Extension, Working Relief, Sports Refresh, Rest & Sleep, Neck & Shoulder, Waist & Spine, Deep shiatsu, Healthy breath, Massage extend according to your own body state and massage time.(3D massage excluded.)





#### Manual programs

When the massage chair is working, press the manual button to select a manual massage. You can choose Shiatsu, Tapping, Knocking, Kneading, Sync ,Rhythm according to your own body state and massage time.



#### Leg up and down

- ▶ Keep pressing “”, the leg rest raises to the highest; stop pressing, the leg rest stays.
- ▶ Keep pressing “”, the leg rest descends to the lowest; stop pressing, the leg rest stays.





#### Zero Gravity

- ▶ Press this button to start or end zero gravity. If the icon on the LCD screen is lit, you are in a zero gravity position. When you manually adjust the backrest and leg rest you are no longer in zero gravity.
- ▶ Zero gravity creates a completely relaxing, naturally comfortable massage position; Somatological design makes back, buttocks and leg stay in a certain angle like lying in space capsule, under which the body pressure is thoroughly released.



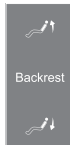

#### Shoulder Position adjustment

- ▶ When it is in manual mode, keep pressing  or  to adjust massage point.
- ▶ The buttons are also for shoulder position adjustment.



#### Backrest up and down

- ▶ Keep pressing “”, the backrest raises to the highest; stop pressing, the backrest stays.
- ▶ Keep pressing “”, the backrest descends to the lowest; stop pressing, the leg rest stays.

## ▶ PREPARATION BEFORE USING

### Proper method for moving the chair

- ▶ There are moving rollers at the bottom of the chair.
- ▶ To move, return the chair to upright, original position.
- ▶ Switch off and unplug the chair.
- ▶ Lift the front part of the chair as shown in the figure (one person raise the front part via the moving holder, another person push the chair while holding the top of the chair.) Move the chair on the rollers.

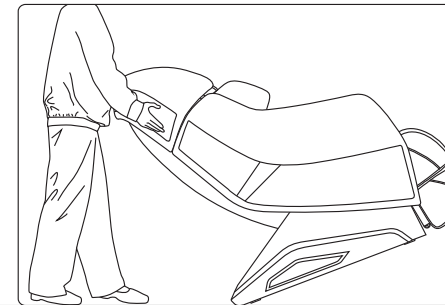

#### Caution

- ▶ Don't move the chair when it is occupied.
- ▶ Don't use the armrest to move the chair. Use the front and back of chair to move.

### Turn on power supply

- ▶ Plug the power cord into grounded three-pronged socket.
- ▶ Turn on the power switch on the bottom of massage chair.

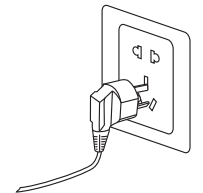

#### Caution

- ▶ Before switching on the chair, please make sure there is no damage to the power cord or other exposed wires.
- ▶ Make sure the power switch is off before the chair is connected to the wall socket.



## PREPARATION BEFORE USING

- ▶ Lift the legrest unit and connect the connectors to the relevant ports on the front frame of the seat frame well.
- ▶ Connect the front of the legrest unit to the seat with zipper.

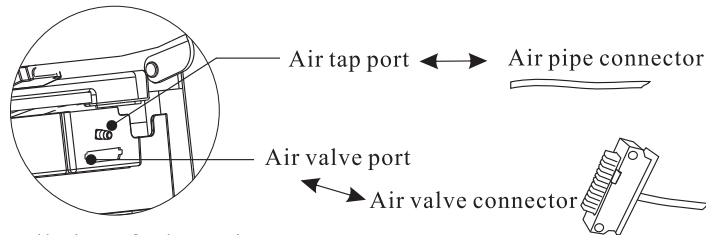

### Step 4 Installation of other units

- ▶ Insert the cord from the remote control into the socket on the power box at the bottom of the chair.
- ▶ Connect the power cord connector to the power cord port on the power box. (See diagram below.)

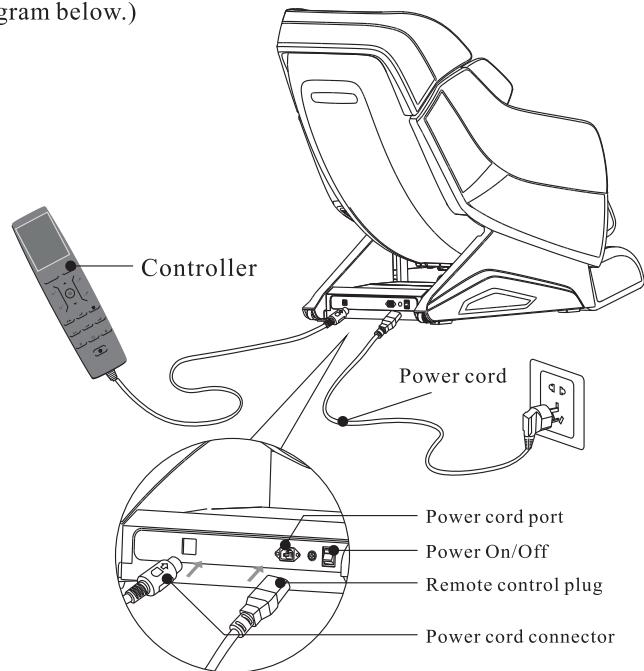

- ▶ After all parts are assembled, please insert the power cord into the wall socket and turn on the switch. Press the power on the remote control to start massage. (See diagram above.)

## NAME AND FUNCTION OF EACH COMPONENT



### Massage speed adjustment

- ▶ Under manual mode, press this button to choose 6 different degrees of massage speed, speed indicator is on the LCD screen.



### Zone massage

- ▶ Touch this button to select FULL, PARTIAL, POINT massage at your back.



### Air Intensity

- ▶ Press this button to adjust the air pressure massage.



### Width adjustment

- ▶ Under manual mode, if the button is lit, it is ready for operation. Press this button to choose wide, medium or narrow massage range.
- ▶ When the button is off, this function is not available.



### 3D massage

- ▶ Press the 3D button to select 3D massage.



### Airbag Zone

- ▶ Press this button to start or end shoulder, leg, seat, whole body airbag massage. Indication on the LCD is on or off.



### Foot Rollers massage adjustment

- ▶ Press this button to start or end foot rollers massage, you can choose high, medium or low modes. There is indication on the LCD screen.



### Timer

- ▶ Press this button to choose timer for massage: 10 mins, 20mins or 30 mins.



### Heating

- ▶ Press this button to start the heating function. The indicator screen will light up. Press this button again to turn on the heating function. The indicator will turn off.

## ▶ NAME AND FUNCTION OF EACH COMPONENT

### LCD screen

#### Auto programs

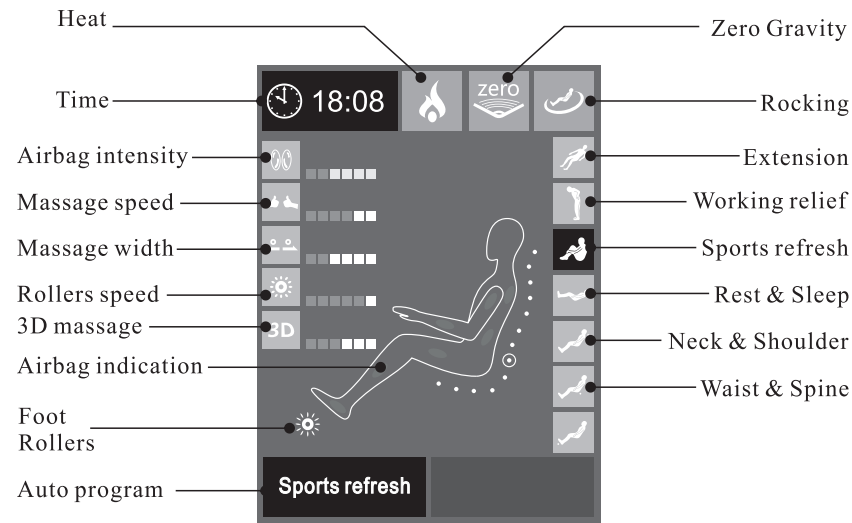

#### Manual programs

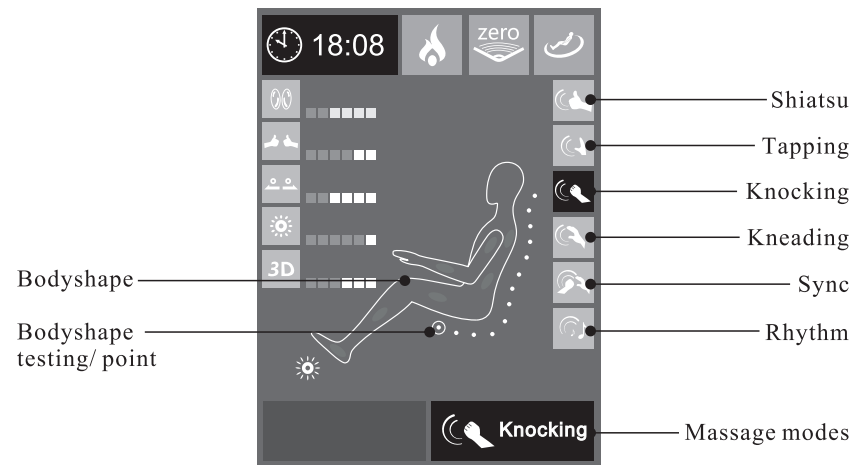

## ▶ PREPARATION BEFORE USING

### Step 3 Installation of legrest unit

- ▶ Lift the calf section and connect it with the seat frame by the hanger. (Pay attention to the balance.) Move the hanger to the axis on one side, then do the same for the other side.

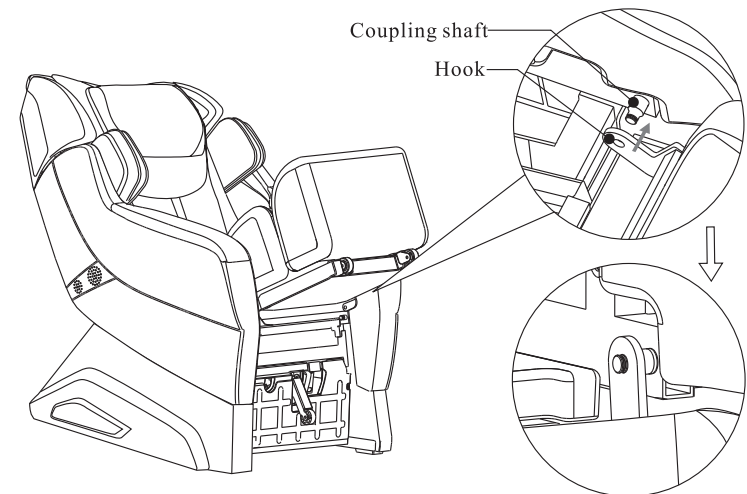

- ▶ After the calf section is connected with the axis, fasten it by the lock on the left and right side. (See the figure below.)

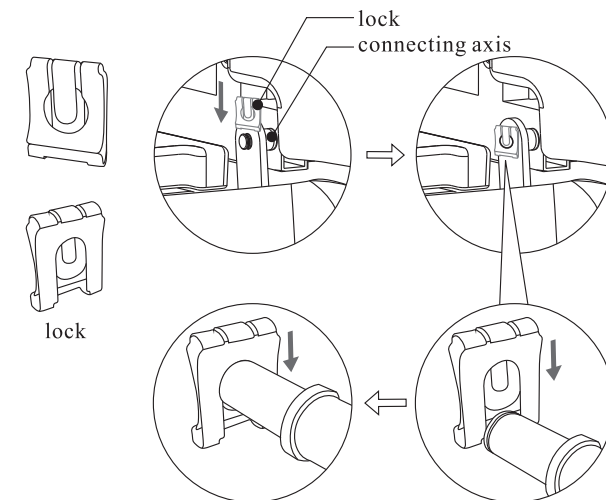

## ▶ PREPARATION BEFORE USING

- ▶ Hang the hook of the armrest on the connecting rod of the backrest.
- ▶ Connect the armrest to the side of the seat frame. Push it down to secure the connection. (Diagram 2)
- ▶ Fasten the armrest to the seat frame with one screw on each side. (Same assembly method for each side of armrest.)

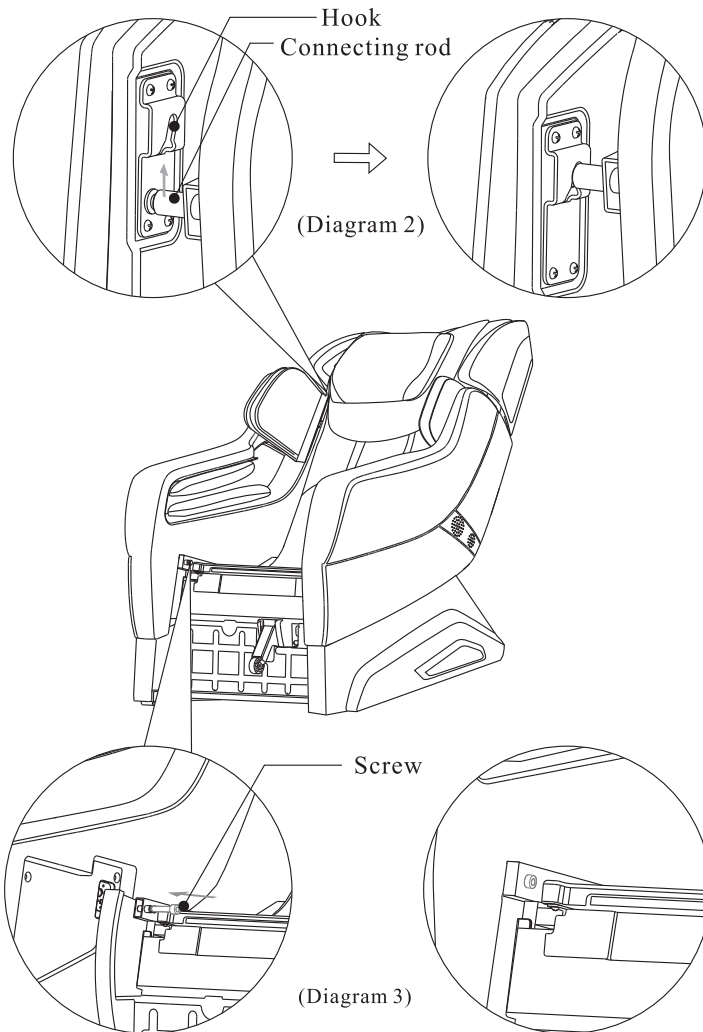

## ▶ NAME AND FUNCTION OF EACH COMPONENT

### LCD Menu

#### ▶ Auto programs

Press Auto to enter the Auto program menu, you can choose Extension, Working Relief, Sports Refresh, Rest & Sleep, Neck & Shoulder, Waist & Spine, Deep Shiatsu, Healthy breath, Massage extend programs.

#### **Sports Refresh:**

This is designed to soothe muscles after a workout. This massage eases and relaxes muscles after intense exercise and promotes circulation to improve muscle recovery.

#### **Extension:**

This is a Thai massage that includes strong kneading and stretching of the body. It effectively stretches legs, waist and other parts and it is the best choice to relax tired muscles and increase flexibility.

#### **Rest & Sleep:**

This massage will improve the quality of sleep and relaxation. The mild massage kneads body parts from heavy strength to light, then from light strength to nothing. This relieves a tired body gradually.

#### **Working Relief:**

This is an exclusive program for those who work long hours at a desk or in an office. It eases muscles and helps the body recuperate.

#### **Neck & Shoulder:**

This massage relieves neck and shoulder pain and tension. 80% of the massage time focuses on the neck and shoulders. The curved design of the chair backrest helps the massage rollers target the shoulders and neck, so it can effectively relieve fatigue.

#### **Waist and Spine:**

Relieves pain of the lumbar area. 80% of the massage time focused on the lumbar region and the rollers target the area to relieve tension.

#### **Deep Shiatsu:**

Deep Shiatsu on the back for 10 minutes.

#### **Healthy Breath:**

5 minute breath health program works along with the chair mechanism's rhythm for breathing in and out for the benefit of the users health.

#### **Massage Extend:**

5 minute program of massage with extend.

#### ▶ Manual programs

Press Manual to enter Manual Program menu and choose Shiatsu, Tapping, Knocking, Kneading, Sync, Rhythm massage modes. (see the pic above)

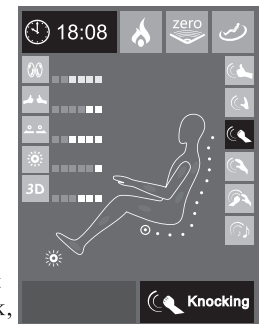
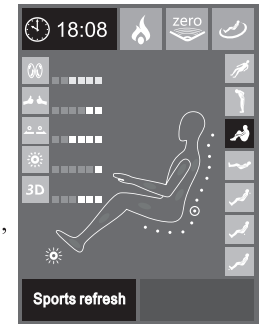

Manual programs interface

## FUNCTIONS AND FEATURES

### 1. Audio Features

The product includes Bluetooth connectivity.

### 2. Shoulder location

Shoulder location function gives the most effective massage for people of different heights.

### 3. Zero Gravity

This chair uses zero gravity technologies from NASA. The chair can angle the legs higher than the heart, imitating weightlessness of space, fully releasing the weight of the body, and relieving stress.

### 4. 3D massage mechanism

The innovative 3D massage mechanism and traveling structure perfectly match ergonomic human engineering.

### 5. Air pressure massage

Air pressure massage for back, waist, shoulder, arm, buttock, calf, and feet.

### 6. Roller massage for foot

Double row rollers conduct an all-around shiatsu massage onto the soles of your feet.

### 7. Diversified massage modes

Diversified massage modes: Knocking, Kneading/Knocking, Kneading, Shiatsu, imitating the skills of a professional masseuse.

### 8. Swing function

This product features a front and rear swing function that relaxes you by gently swinging the chair.

### 9. L shape super long massage track

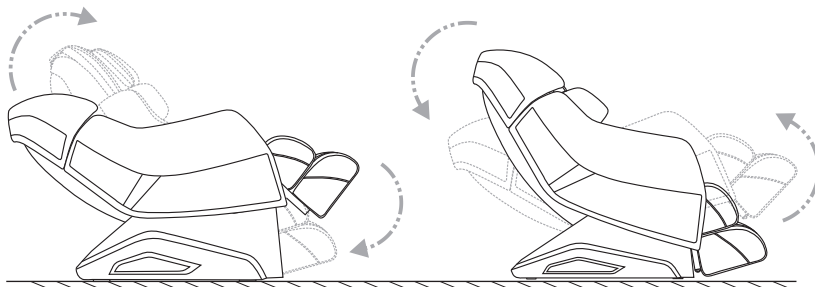

## PREPARATION BEFORE USING

### Installation Method

- ▶ Unpack all parts of the chair
- ▶ Unpack the cartons. Carefully remove sewing units, accessories box and other items.
- ▶ Check all accessories against the packing list.

#### Installation of armrest

- ▶ Connect the power cord and remote control to the relevant sockets on the power box. Turn on the power and put the backrest to the original, upright position. (Follow the sequence in the diagram below.)
- ▶ Match the air valve, air-pipe plugs on armrest to the side ports on the lower part of the armrest frame. (Diagram 1)

