

# FLOOR-TO-CEILING WINE RACK



# FLOOR-TO-CEILING WINE RACK

**RECOMMENDED TOOLS:** Tape measure, Level, Pencil, Electrical drill, Stud finder, Hammer, and Clamps

## PACKAGE CONTENTS

2 Floor-To-Ceiling frames (Top + Bottom)

Screws

## INSTALLATION STEPS

**IMPORTANT:** When securing the FTC to a location, use the appropriate mounting fasteners. There are 4 fastener locations on the top and bottom brackets.

### STEP 1: MARK SCREW HOLES

Mark the screw holes for the mounting brackets in the desired mounting location.

### STEP 2: MEASURE CEILING HEIGHT

Measure the ceiling height in the location you will mount the frame.

### STEP 3: MAKE CALCULATIONS

Calculate the height of your ceiling, then subtract the height of the top frame to give you the measurements for your bottom rail.

### STEP 4: MARK BOTTOM FRAME

Mark the bottom frame to determine the cut location.

### STEP 5: CUT FRAME

Cut the frame in marked location using a metal-cutting hack saw.

Note: Do not use a metal cut off wheel as the heat will damage the product.

### STEP 6: CONNECT THE TOP AND BOTTOM FRAMES

Drill holes on the bottom frame, and then use the hardwares to connect the TOP and BOTTOM frames. Ensure that the holes for the TOP and BOTTOM frames are lined up in the desired location.

**PRO TIP:** Pre-drill holes before installing the Floor-to-Ceiling mount.

### STEP 7: MOUNT BRACKETS

Mount the brackets to the ceiling then the floor using the appropriate anchors. Do not over-tighten.

### STEP 8: MOUNT RAILS

Mount rails to frame. Use all mounting holes to fasten rails securely.

**PRO TIP:** Adjust the rails positions if necessary. Use clamps to hold rails in place while mounting.

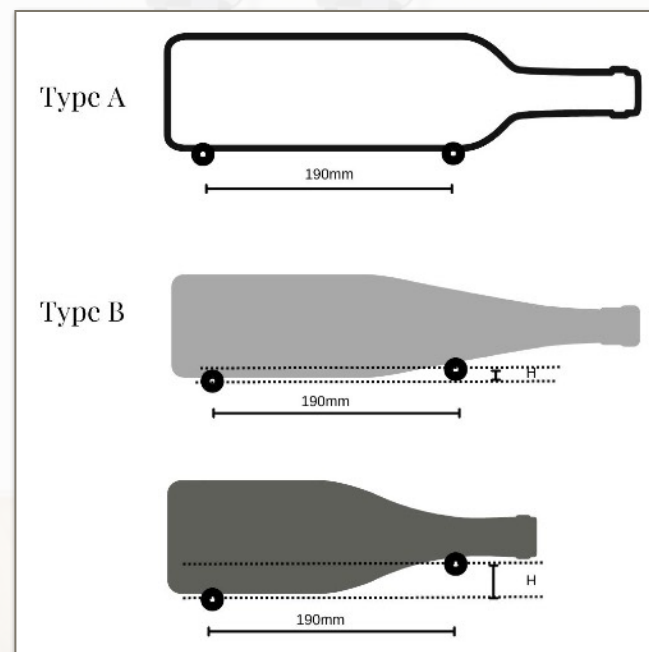

To achieve the ideal horizontal level of your bottle collection, please adjust the positions of the left and right rails to accommodate the unique shapes and sizes of your bottles.

# FLOOR-TO-CEILING WINE RACK

(1-Bottle depth 24 Bottles)

Ax4

Metal Rails



Cx1

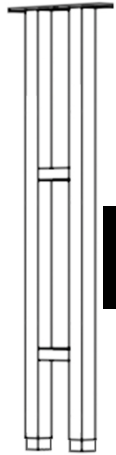

Dx1

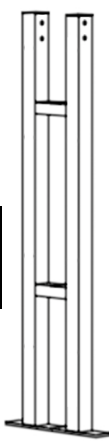

FTC  
Frame

Bx24

Wine Pegs

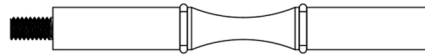

Ex4

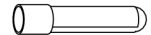

Fx4



Gx4



Hx4



Ix8



1

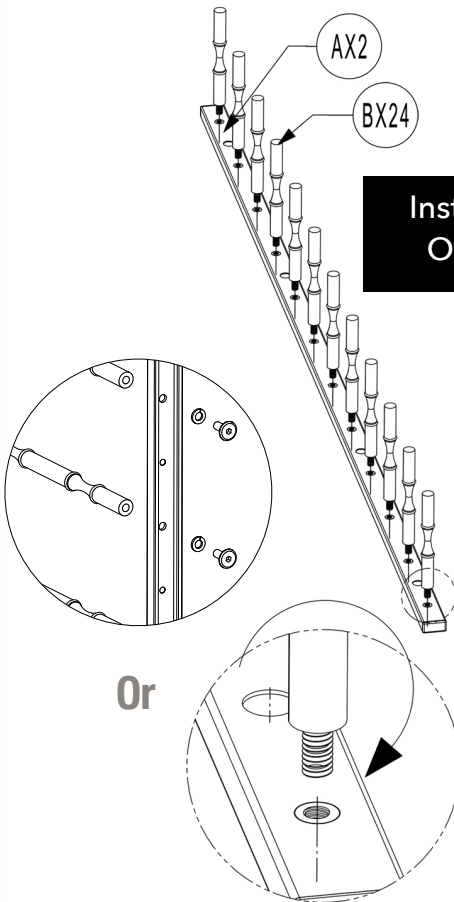

Install Wine Pegs  
On Metal Rails

Or

2

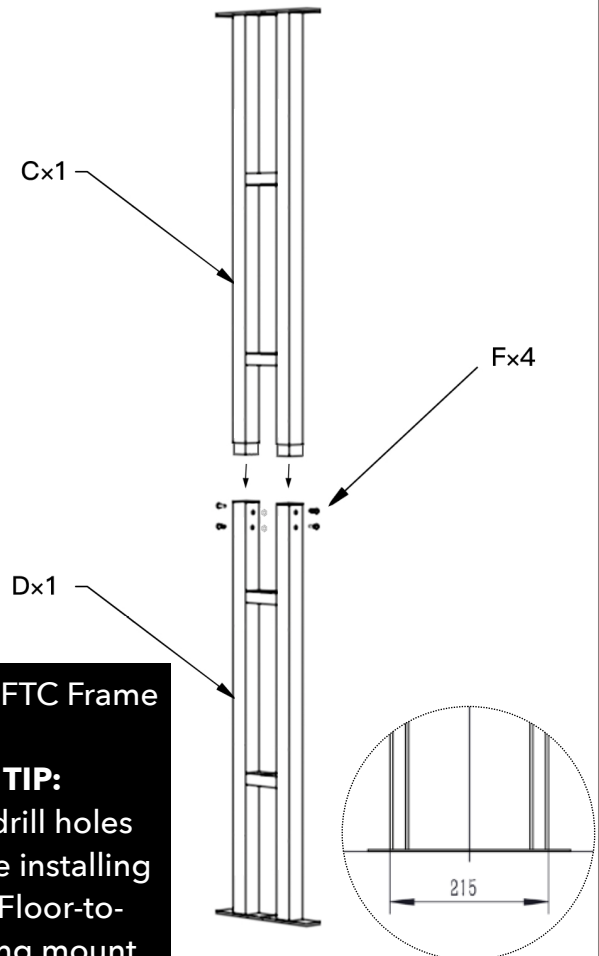

Install FTC Frame

**TIP:**  
Pre-drill holes  
before installing  
the Floor-to-  
Ceiling mount

215

3

Mount rails to frame

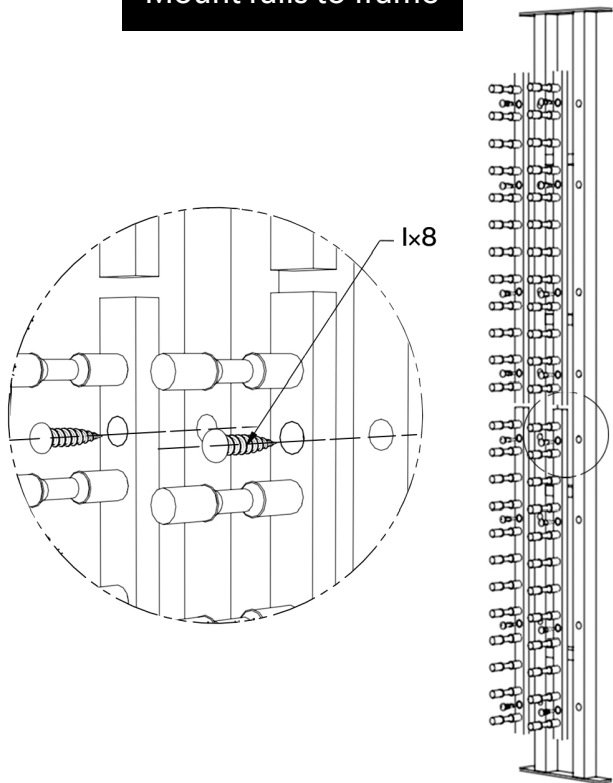

4

Mount the brackets to the ceiling then the floor

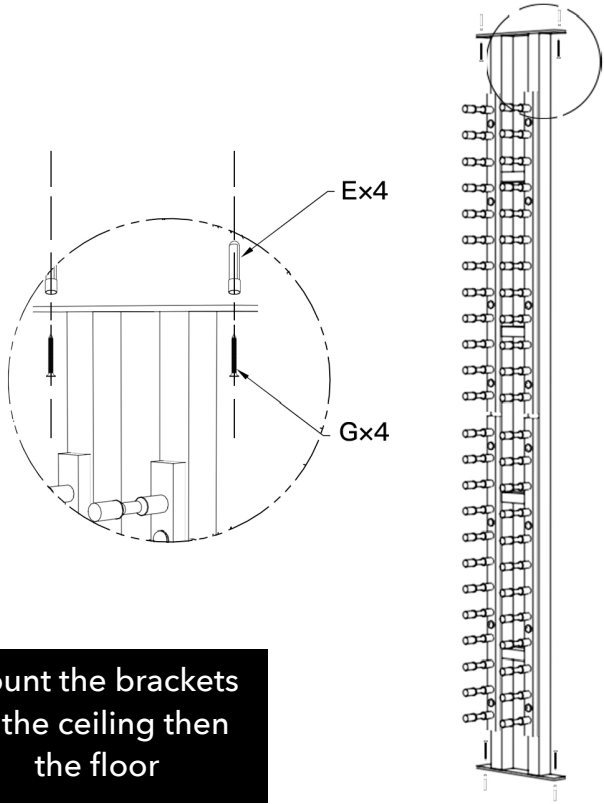

5

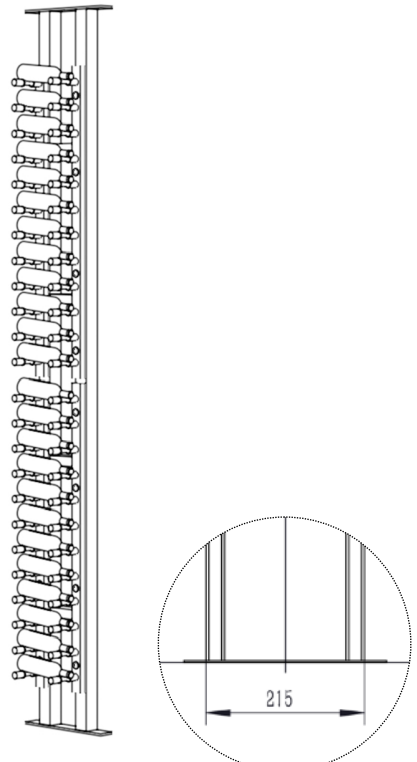

6

Type A

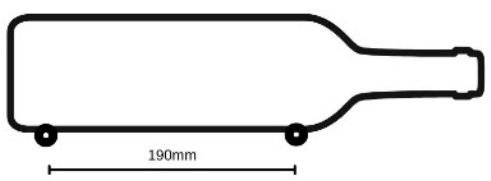

Type B

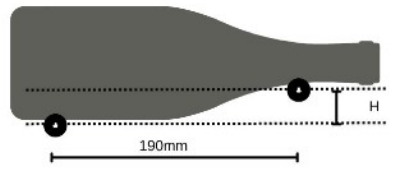
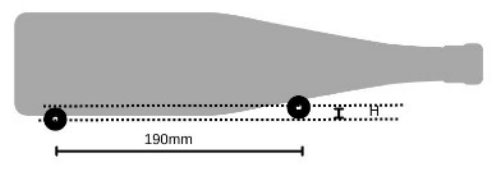

To achieve the ideal horizontal level of your bottle collection, please adjust the positions of the left and right rails to accommodate the unique shapes and sizes of your bottles.

7

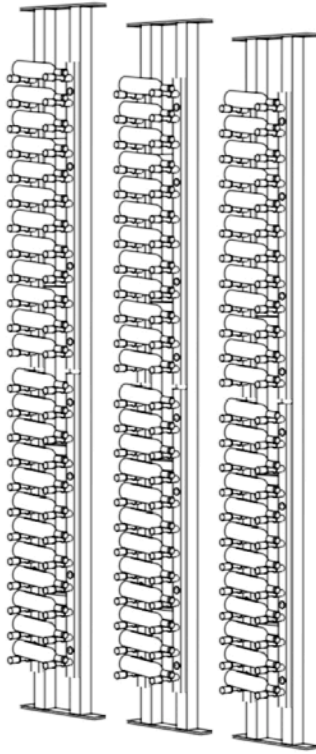

8

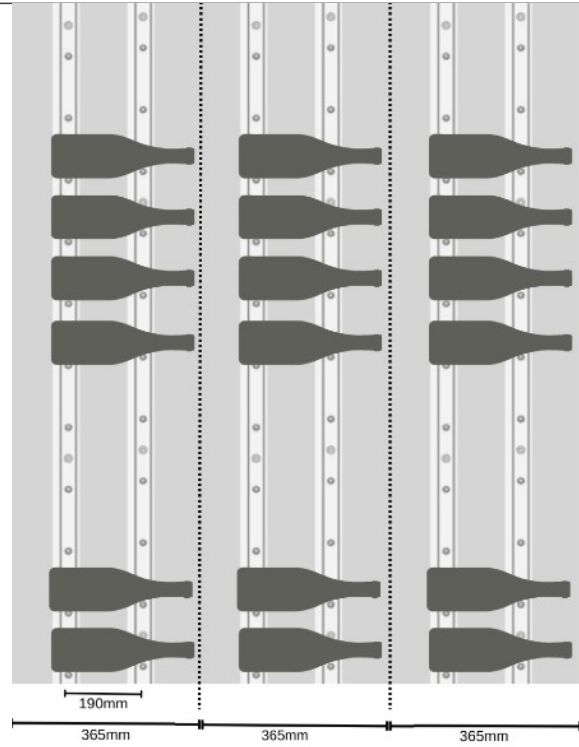

When installing more than one set of wine racks, the minimum horizontal spacing (distance between the centers of two sets) shall be 365mm.