

EAGO

EAGO Sanitary Ware Co., Ltd.

Factory Add: Shiling Development Zone, Xiaotang Town, Nanhai District, Foshan City, Guangdong, China

National Service Hotline 800-8301359

EAGO

DZ956F8 Installation Instruction

Important safe information

1. Please read this instruction and assemble the steam shower according to it.
2. The leakage protection switch must be installed. Besides, please try it to check whether it is safe enough before formal using.
3. The ground line of the product must be connected to the earth permanently.
4. To avoid being shocked by the electricity, please prepare enough plugs and fixed them near to the steam shower. Please change those old or disrepair wires in time.
5. It is strictly forbidden to use the steam shower after drink or eat some hypnotic medicine.
6. Children should be guided by parents while using.
7. Especially note: The using water temperature should not pass 60 centigrade or 140 Fahrenheit.
8. Do not use any strong chemical liquid such as Vitriol, Hydrochloric acid, Lye and so on to clean the steam shower.
9. There is a connecting screw in the Wire Connecting Box, to avoid being shocked by the electricity, please be sure to connect this screw to the ground wire which is fixed on the power board. It is better to use the same size insulated wire to connect them, and the connecting wire diameter should not less than 1.5 square millimeter cooper-core wire.
10. Warning: To avoid being shocked by the electricity, please be sure to connect the DFCI/RCD to the ground plug.
11. If the steam shower with 3KW/4.5KW/6KW steam generator, the diameters of wires which are used not less than 2.5square millimeter/ 4square millimeter/ 6square millimeter.
12. It is not allowed to use any moisture enhancing machine in the steam shower.

Installation wiring diagram

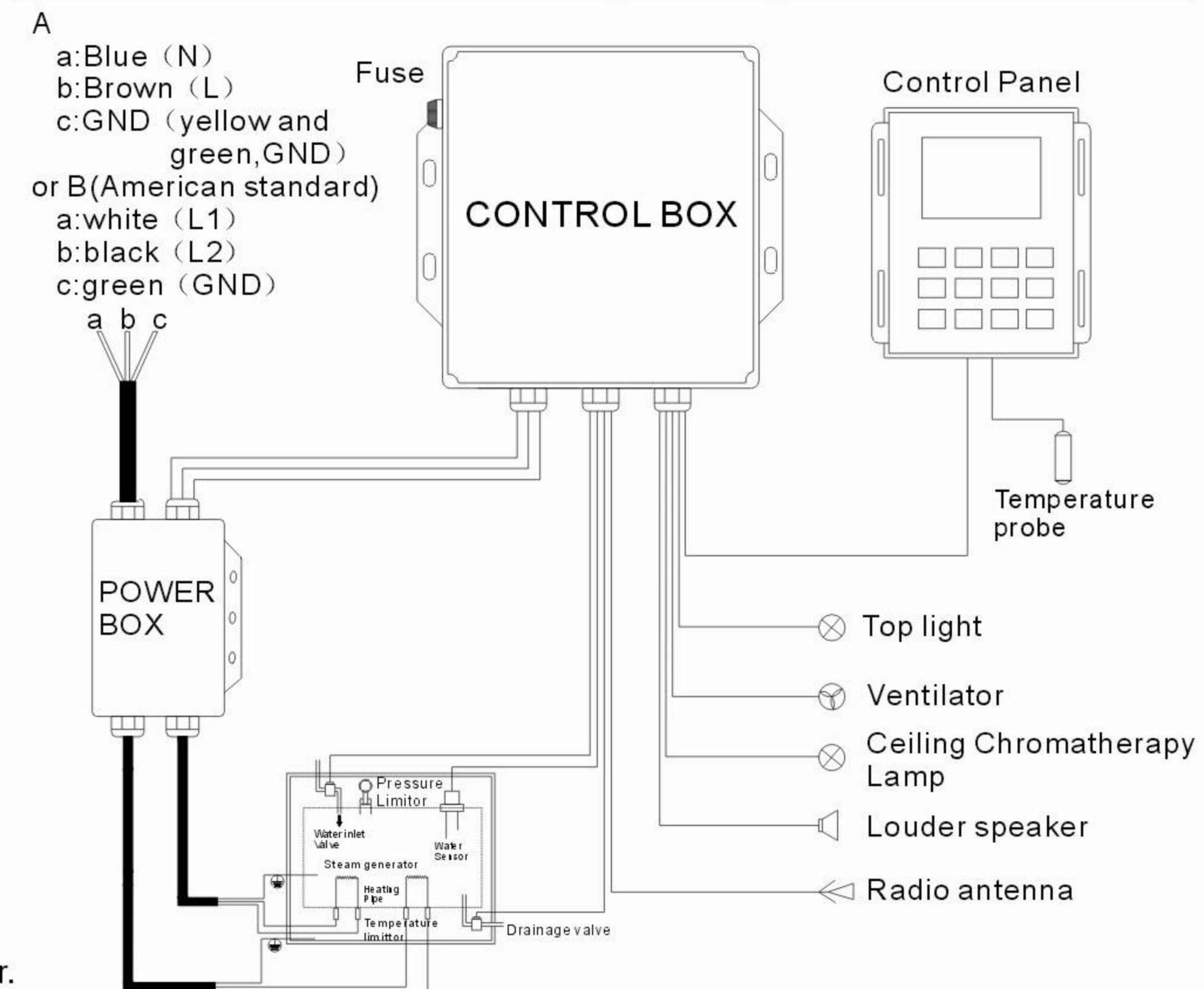

Electrical parts specification

Configuration Parameter	massage pump	steam generator	ceiling light	exhausting fan	Solenoid valves	CPU	Speaker	Note
Rating voltage		AC220-240V/50HZ	DC12V	DC12V	DC12V	AC220V-240V/ 50HZ		
Rating voltage		AC240V/60HZ	DC12V	DC12V	DC12V	AC240V/60HZ		
Rating power		3000W	10W	3W	5W		10W	
Rating power		4500W	10W	3W	5W		10W	
Rating power		6000W	10W	3W	5W		10W	

CONTENTS

- 01-02 Component Directions
- 03 Technical Drawing
- 04-10 Installation steps
- 11-12 Control panel keys and function directions
- 13 Illustration for cleaning function
- 14 Maintenance service card
- 16 Troubles shooting



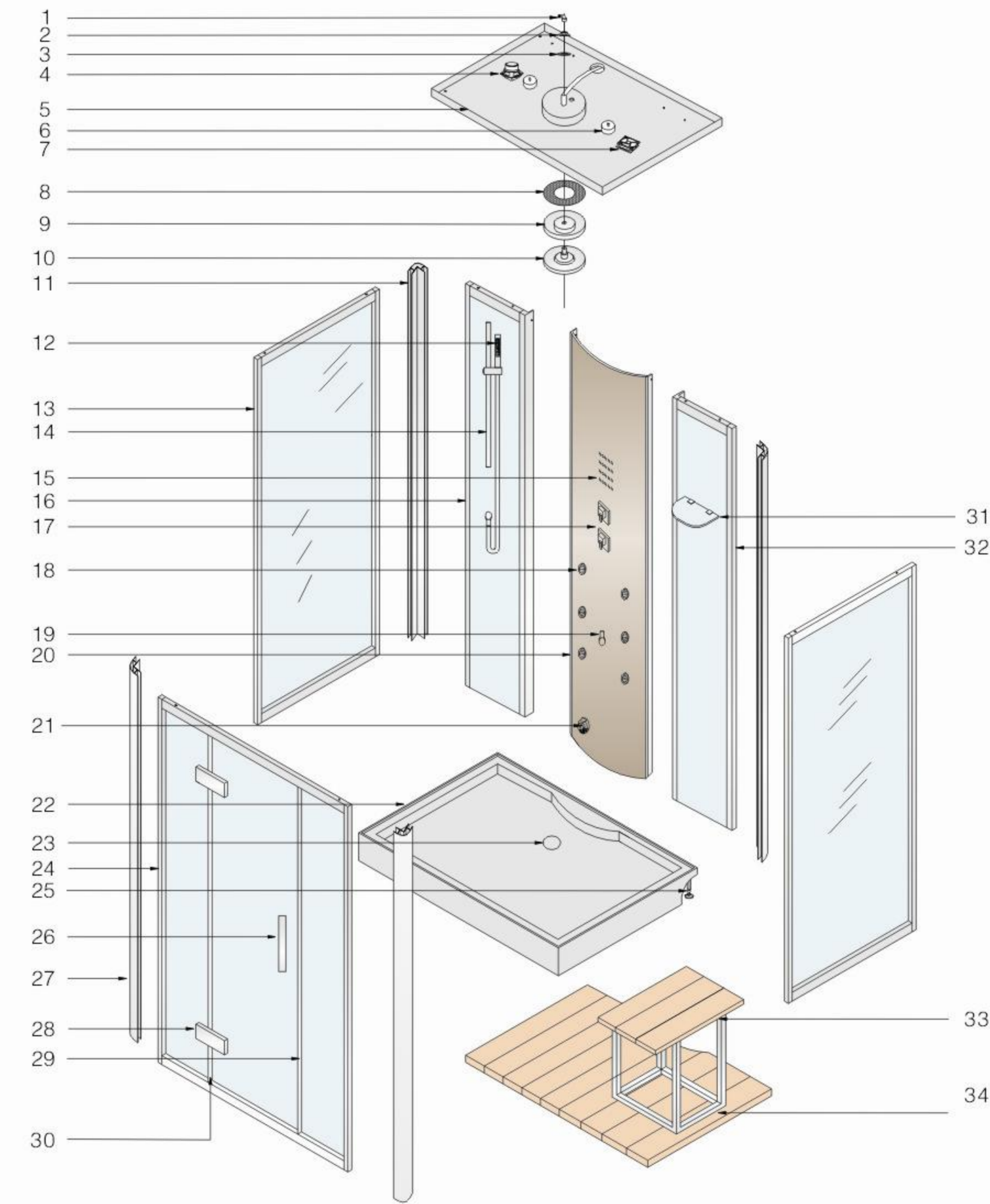





Parts instruction



1、4"4 copper elbow	2、1/2" copper nuts	3、4' black plastic gasket	4、Loud speaker
			
5、Top cover	6、daylight lamp	7、90X90 Ventilator	8、steam room big chromatherapy light
			
9、acrylic light cover(big)	10、shower head	11、side corner aluminum profile	12、hand shower
			
13、left side panel	14、Hand shower bracket	15、F8 control panel	16、left back panel
			
17、faucet	18、Jet	19、cleaning cup	20、mid back panel
			
21、steam mouth	22、shower base	23、Plastic drainer	24、glass door
			

Parts instruction

Parts package

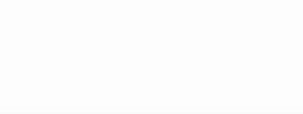
25、Adjustable leg	26、H-style handle	27、corner aluminum profile
		
28、door hinge	29、L008A magnetic strip(6mm)	30、water proof rubber
		
31、glass shelf	32、right back panel	33、stool
		
34、solid wood floor		
		

4x10 self-drilling screws: 16pcs	4x16mm screw with cushion: 18pcs
	
4x20 self-drilling screws: 15pcs	
	

Technical drawing for water and electricity

Size: 1500X900X2220mm

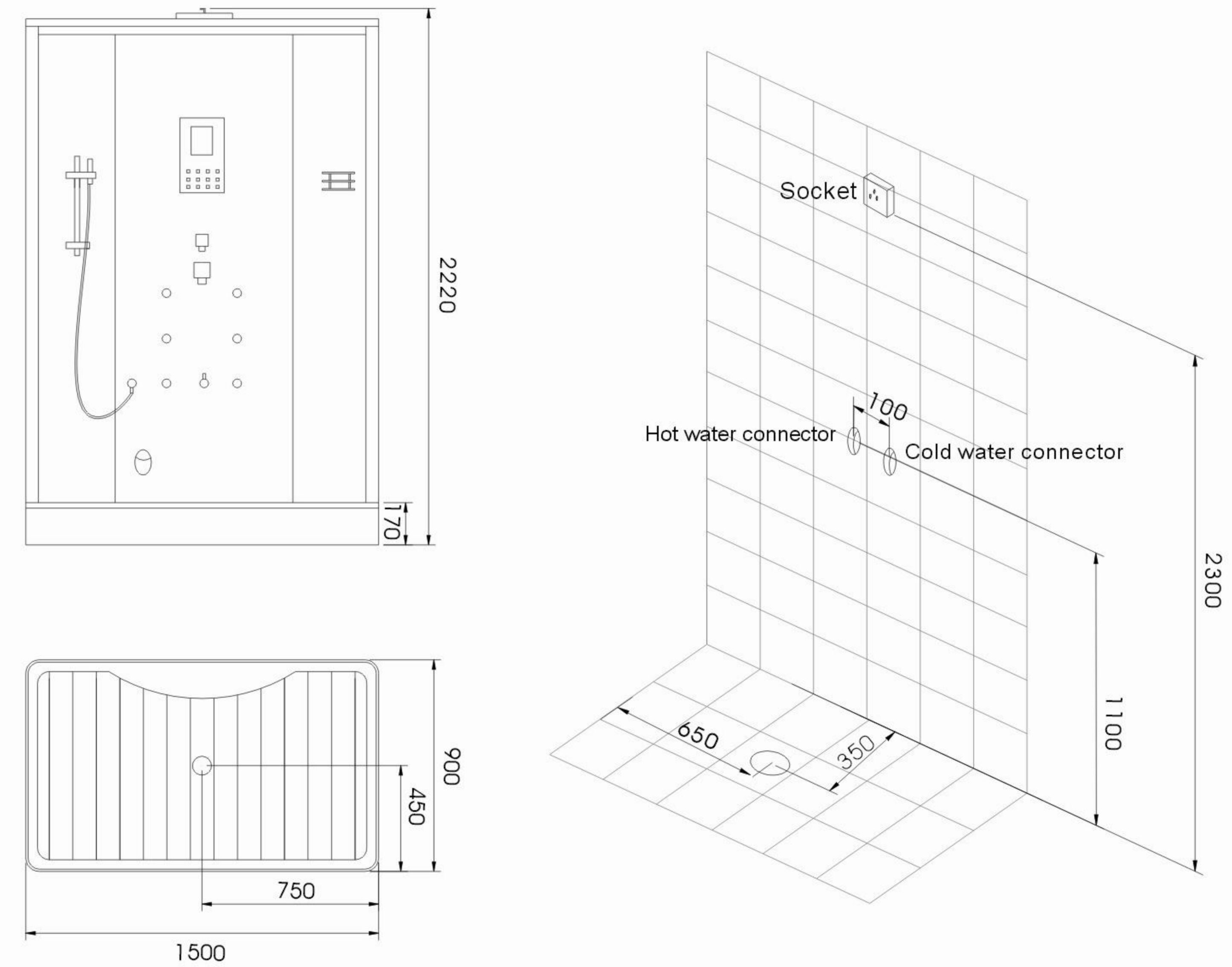

Installation instruction 1

Install the shower base

1. Take the shower base out from the carton and put it on the floor carefully.
2. Put the level ruler on the shower base to check whether the shower base is level. If not, please use a Wrench to adjust the adjusting legs to make the shower base become level. Illustrated in the drawing A.

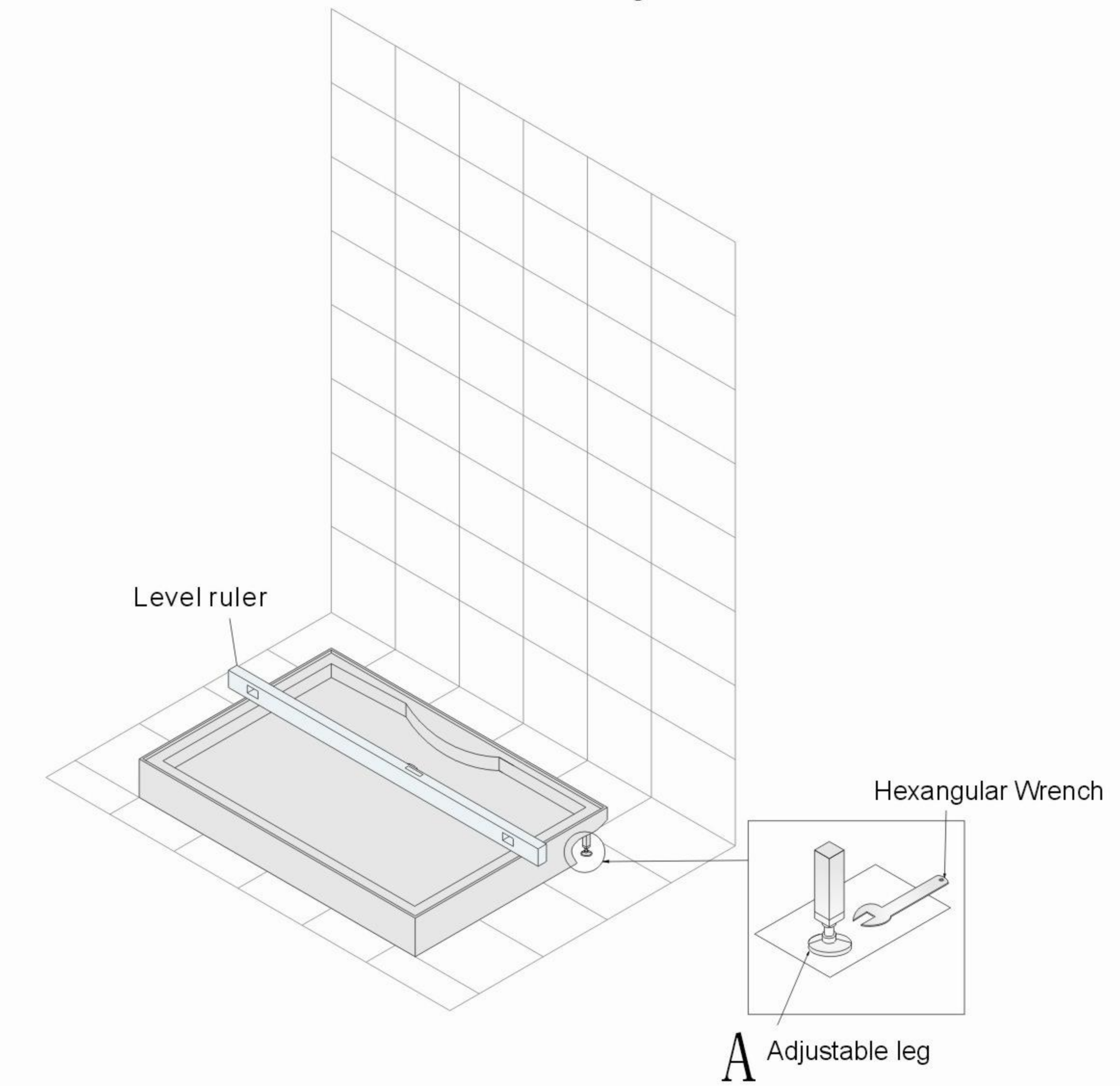

Installation instruction 2

Install the Side Panels and the Fixed Doors

1. Put the No.1 left fixed door on the base carefully. Ask one person to stand beside to hold it on.
2. Insert the Left Corner Aluminum Profile into the No.1 fixed door, and then use 4x10mm self-locking screws to fix them well. Illustrated in the drawing A.
3. Put the No.2 left side panel on the shower base, and insert it to the Left Corner Aluminum Profile as well. Then use a Phillip Screwdriver to fix them with 4x10mm self-locking screws. (Note: For the Corner Aluminum Profile, the upper side with holes on the top, so please not install it in a wrong way).
4. Use the same way to install the No.3 side panel and fix it to the fixed door as well.

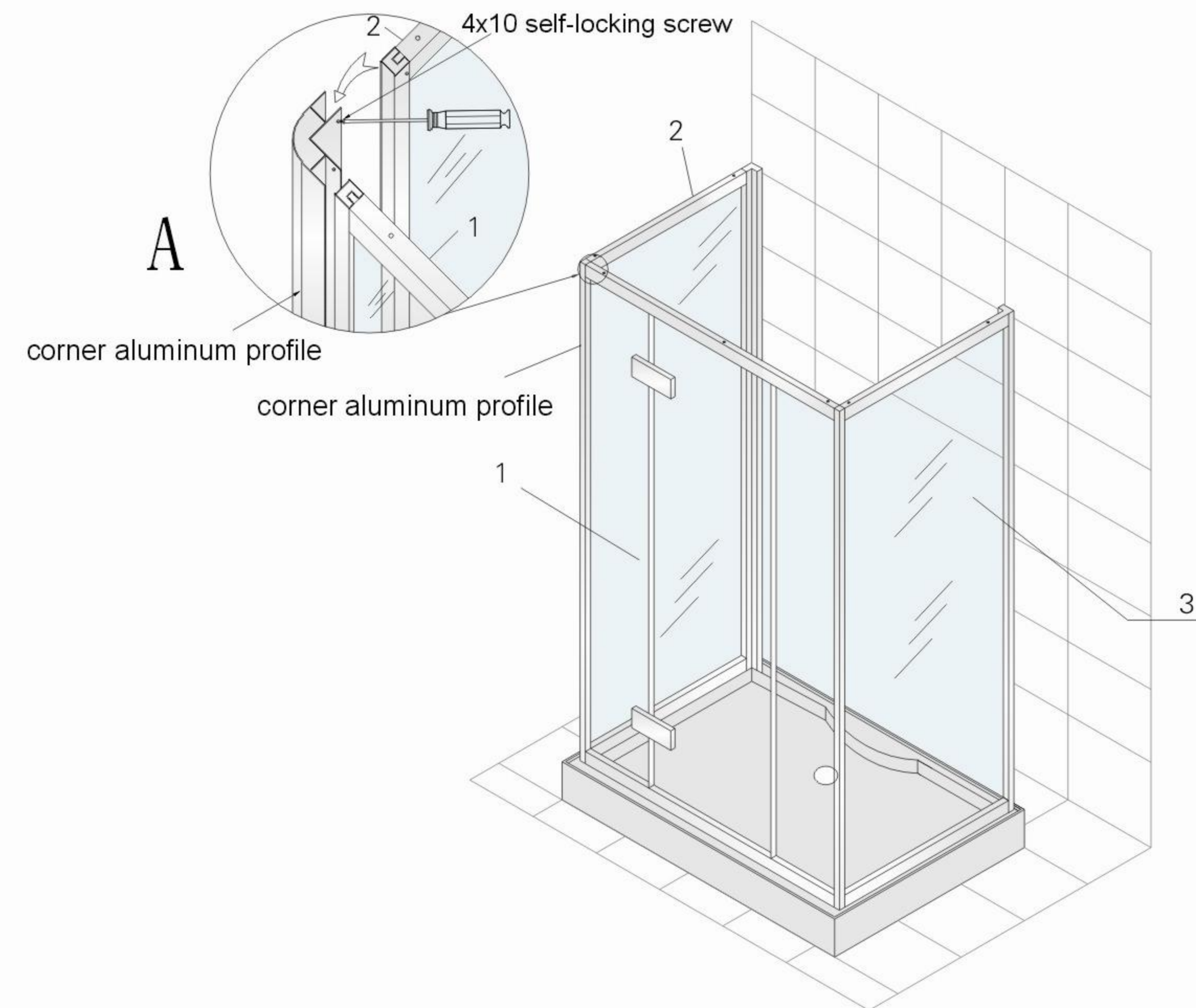

Installation instruction 3

Install right and left back panels

1. Put another Corner Aluminum Profile on the shower base and insert it to the No.2 side panel, then use a Phillip Screwdriver to fix them well with 4x10mm self-locking screws. Illustrated in the drawing A. Note: For the Corner Aluminum Profile, the flat end is the upper side, please don't put it in a wrong position while installing.
 2. Put the No.4 left back panel on the shower base, and insert it to the Corner Aluminum Profile, then Use a Phillip Screwdriver to fix No.4 and No.2 panels with 4x10mm self-locking screws.
- Use the same way to install No.5 right back panel, and fix it to the No.3 side panel.

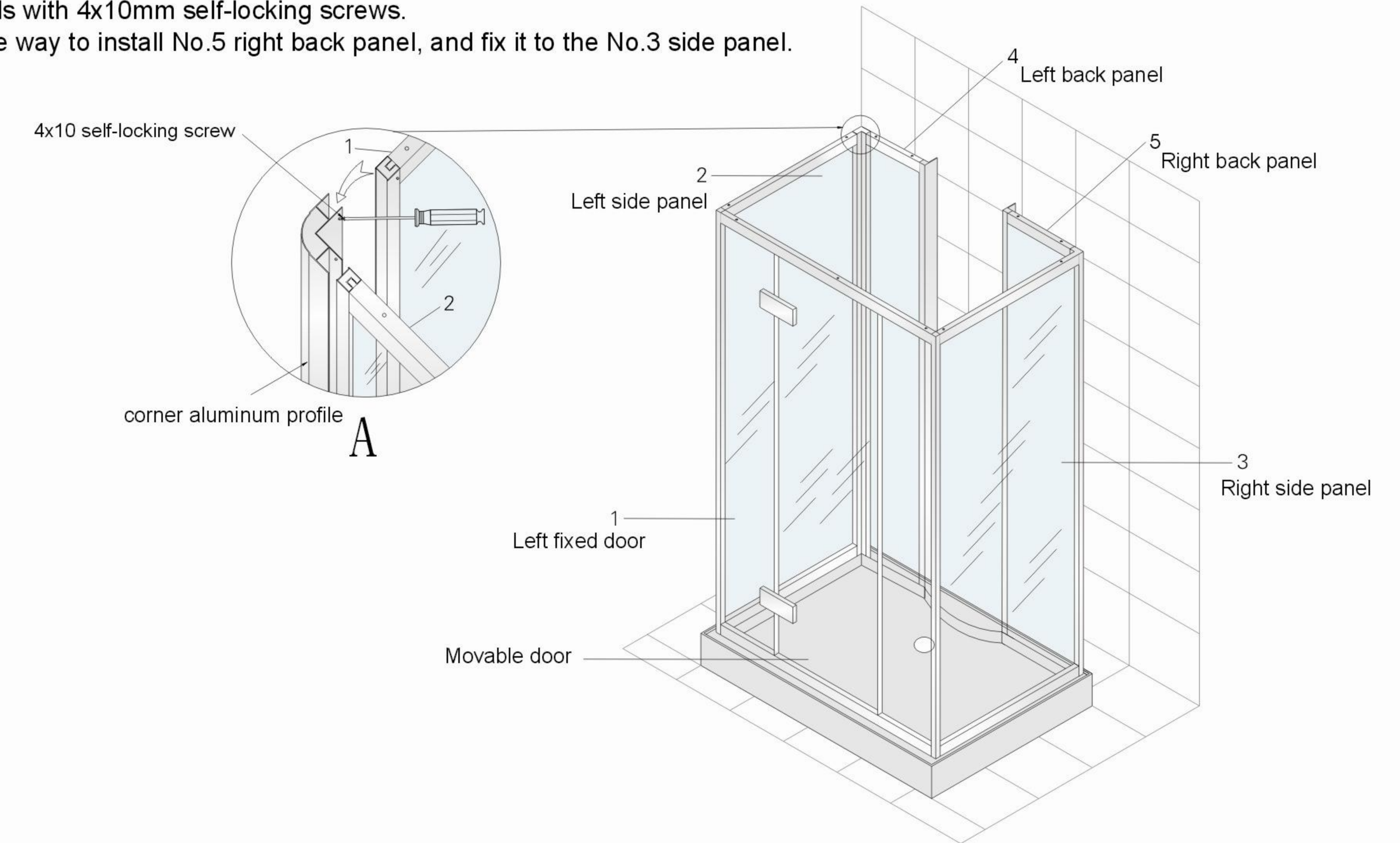

Installation instruction 4

Install the Mid Back Panel

1. Put the No.6 mid back panel on the shower base, and use a Phillip Screwdriver to fix it to No.4 and No.5 back panels with 4x16mm screws, illustrated in the drawing A.
2. Use a Phillip Screwdriver to fix all the back panels to the shower base with 4x20mm self-locking screws. Illustrated in the drawing B.

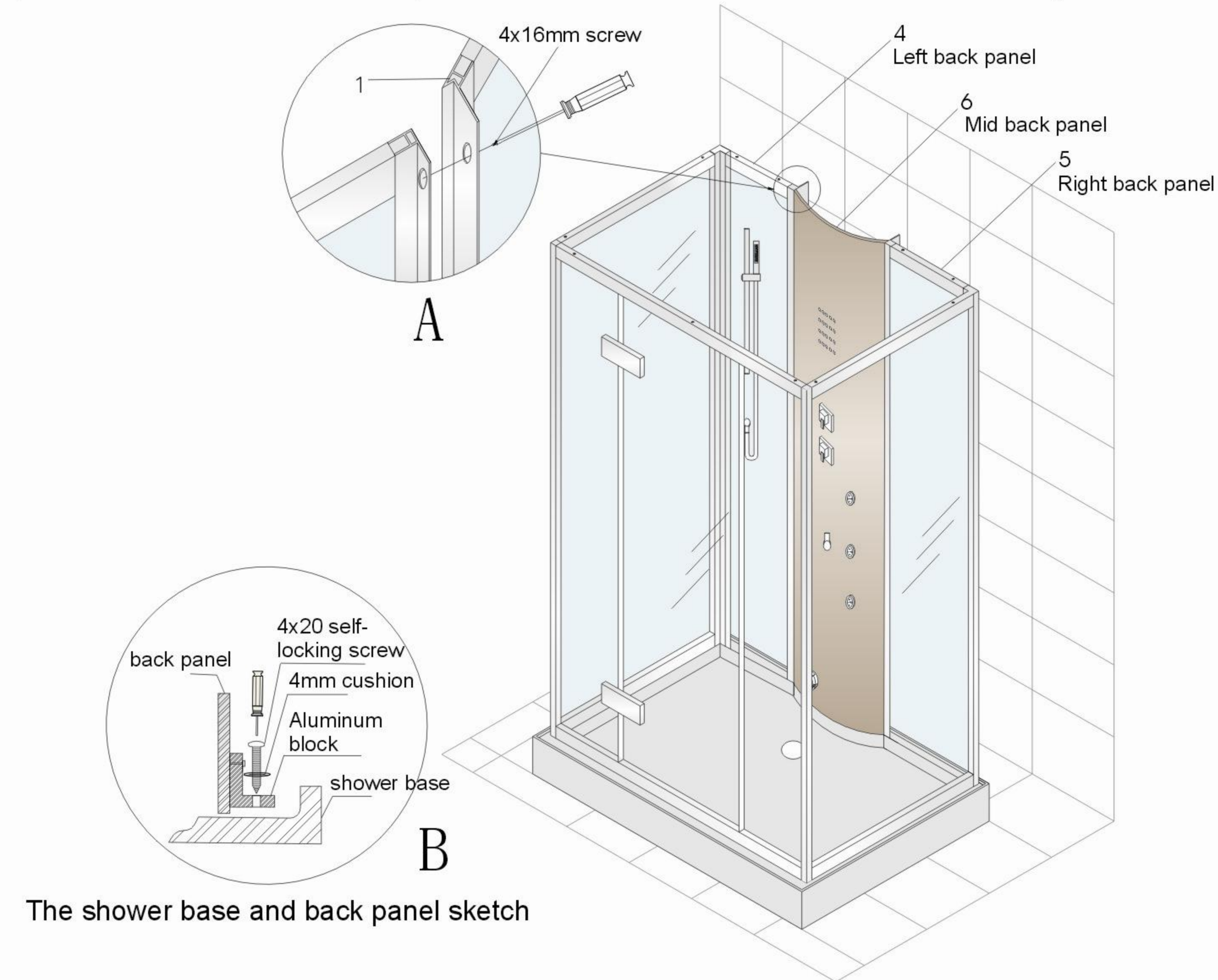

Installation instruction 5

Install Accessories

1. Install the Up and Down Hand Shower Socket: Use a Phillip Screwdriver to install the Up and Down Hand Shower Socket to the back panel with 4x16mm screws, 4mm plastic cushion, 6mm plastic cushion and 4mm nuts. Illustrated in the drawing A.
2. Connect the hand shower chain to the hand shower socket. Illustrated in the drawing B.
3. Install the Glass Shelf: Use a Phillip Screwdriver to fix the Glass Clip to the back panel with 4x16mm screws, 4mm plastic cushion, 6mm plastic cushion and 4mm nuts, illustrated in the drawing C. Then put the Glass Shampoo Holder on the track of Glass Clip and use a Phillip Screwdriver to fix them well. Illustrated in the drawing D.
4. Use a Hexangular Wrench to fix the handle to the Movable Door. Illustrated in the drawing E.

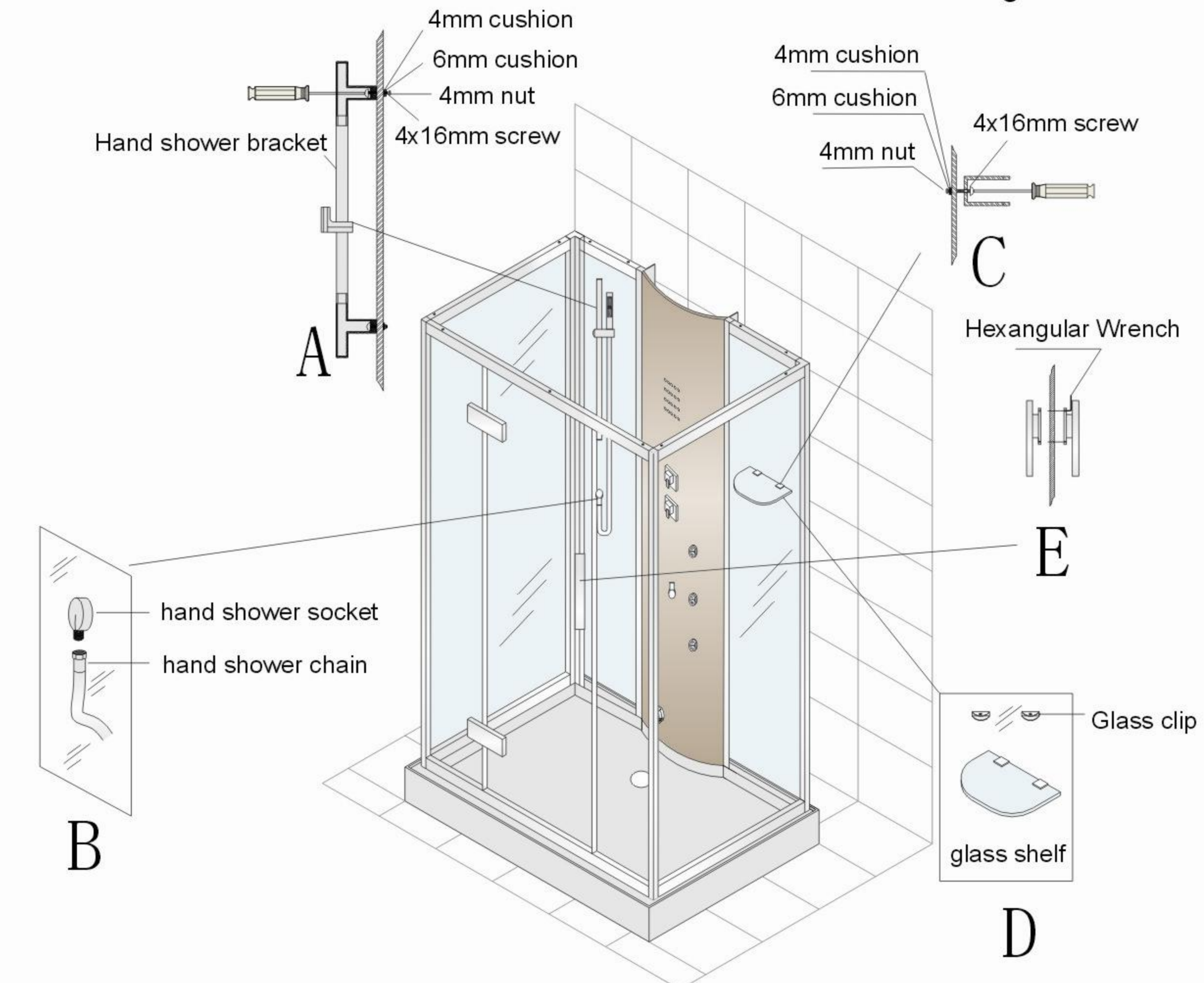

Installation instruction 6

Install Top Cover and Connect Fittings

- Put the top cover onto the top of the back panels and doors, illustrated in the drawing A. Then use a Phillip Screwdriver to fix the top cover to all the back panels with 4x20mm self-locking screws.
- Put the solid wood floor in the steam shower carefully.
- Find out the Ventilator sign, the Lamp sign, and the Loud Speaker sign which are on the behind of the back panel, then connect the relative wires of these spare parts to the relative sockets. Illustrated in the following drawing.

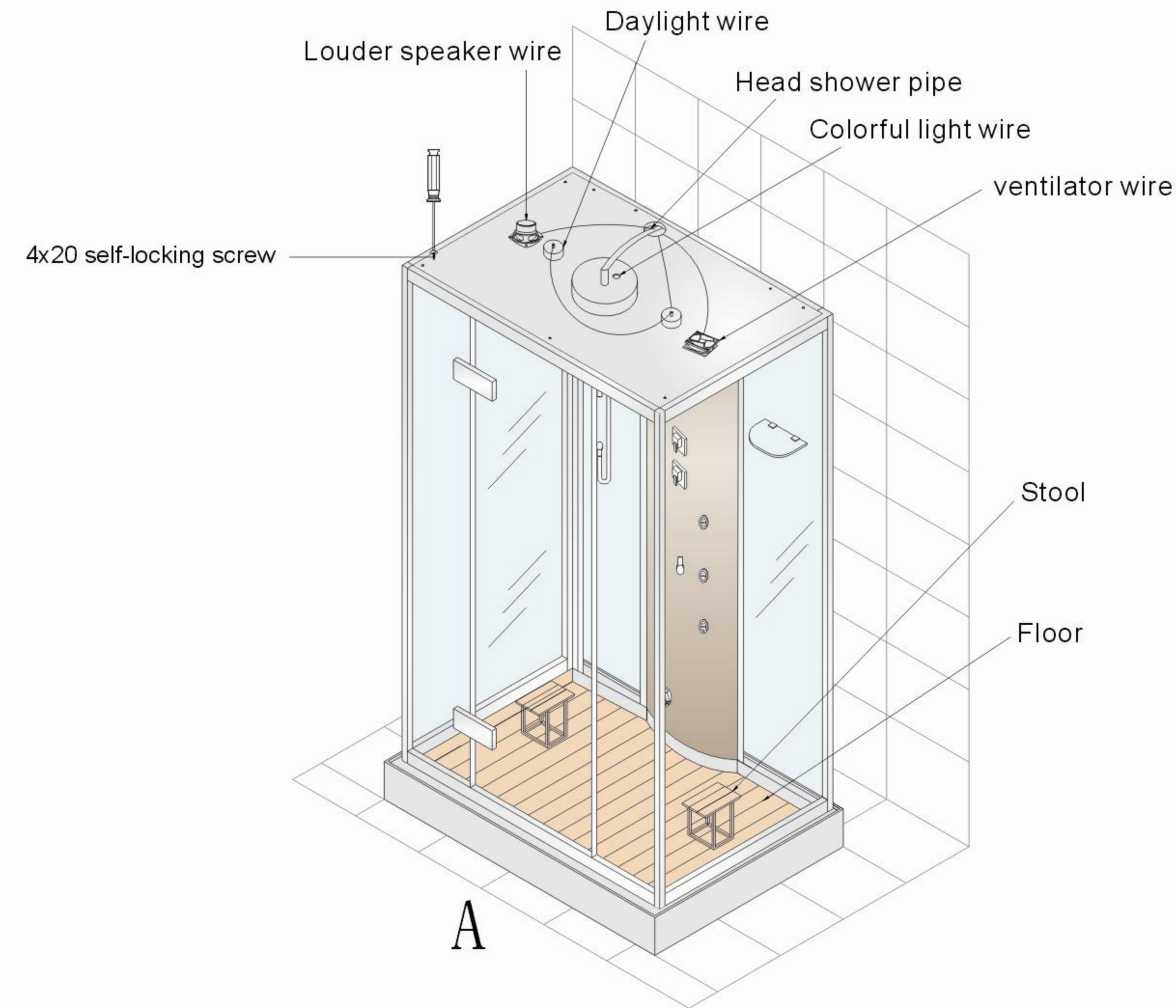

Installation instruction 7

Connect Fittings and Water Pipes

- Connect the head shower pipe to the head shower joint. Connect the water outlet pipe to the shower base and connect the steam pipe to the steam outlet, illustrated in the drawing A.
- Connect the hot water inlet pipe and the cold water inlet pipe separately to the relative joints. Illustrated in drawing A, B and C.
- Especially note: The thermostatic faucet is an optional function, just when customers require to install this spare part and we will do, the standard steam shower is without the thermostatic function. Illustrated in drawing D and E.

Note: Before use the steam shower, please try to test whether all the functions are ok.

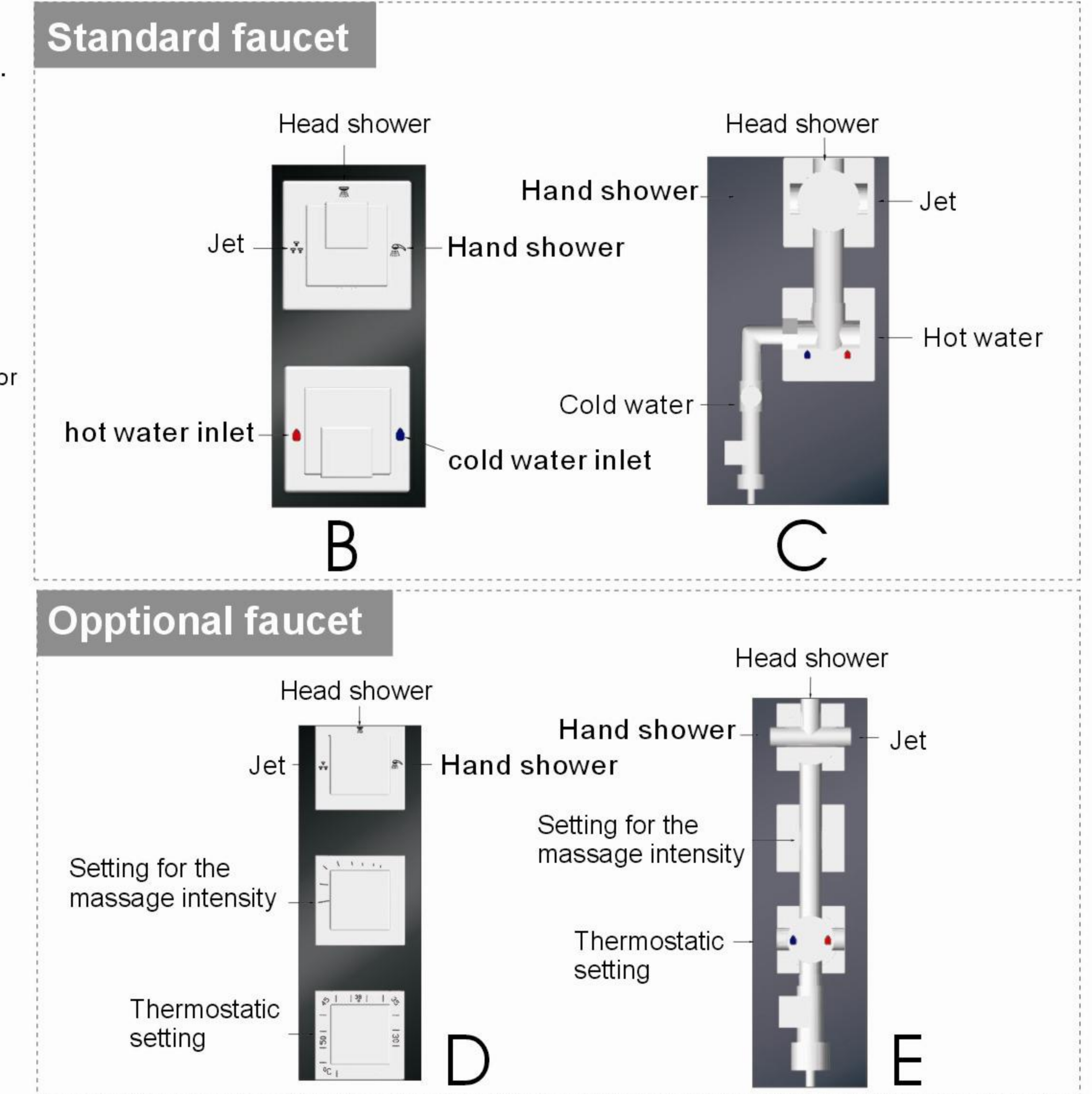
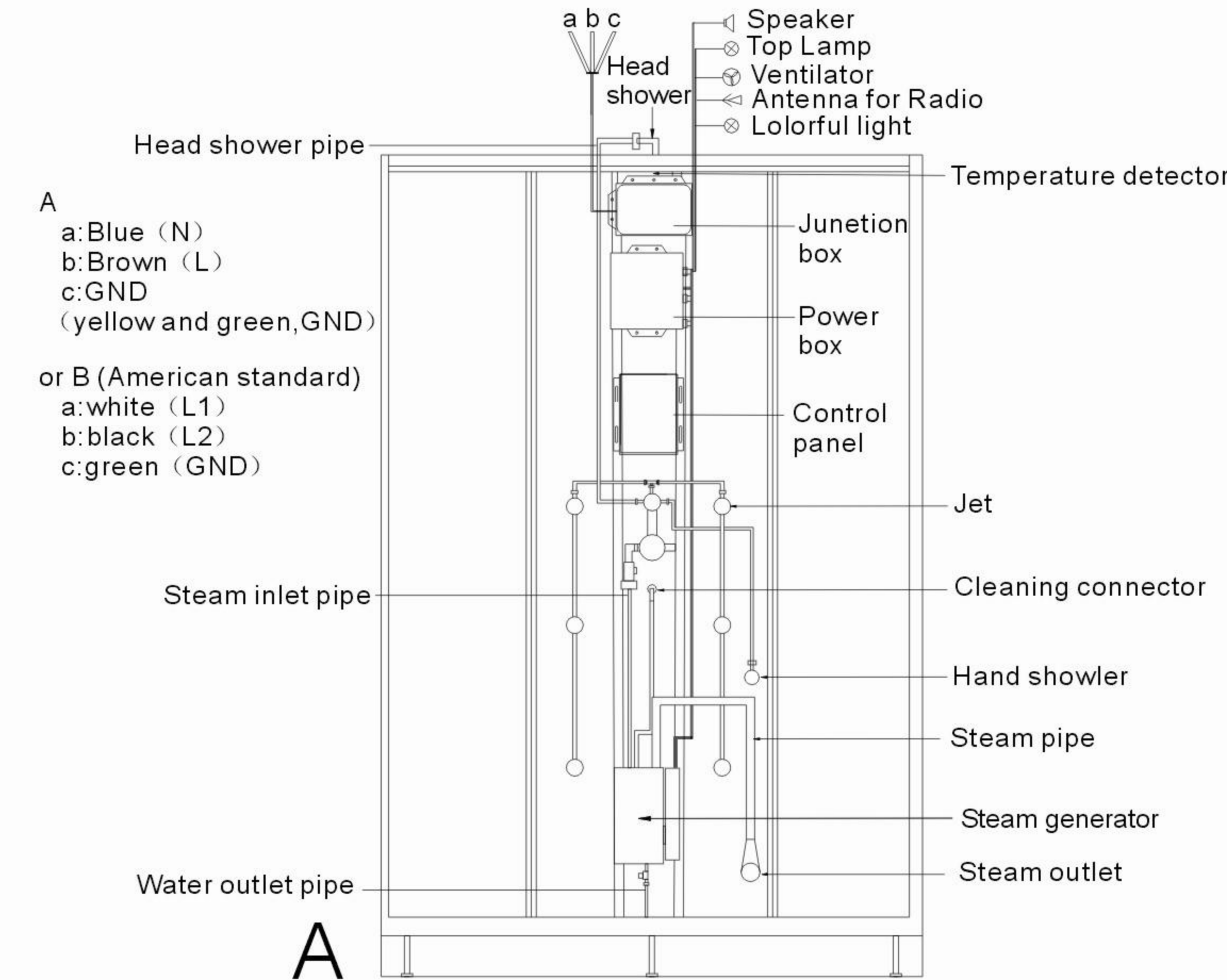

F8 Control panel keys and operating instructions

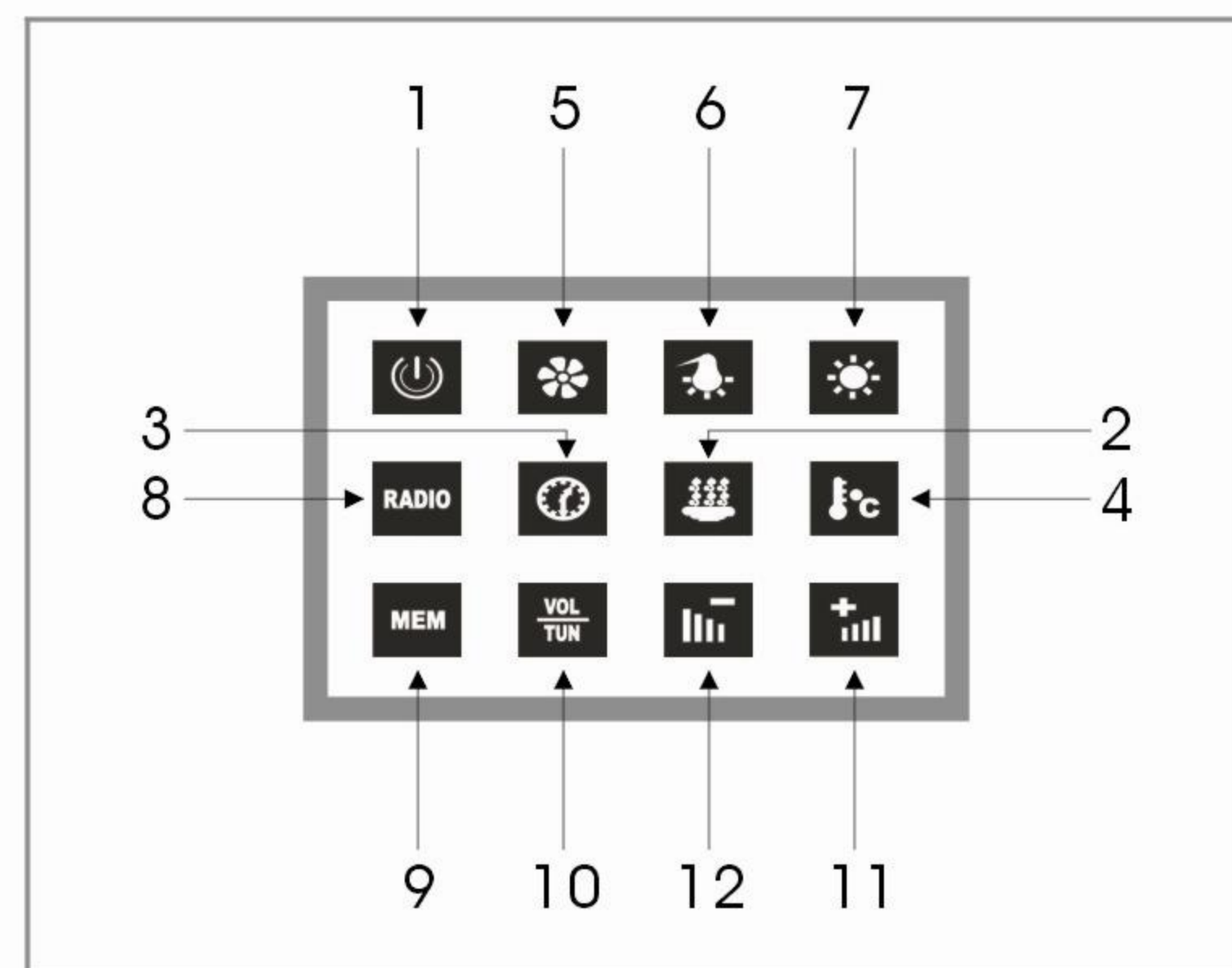

1).Power key

Press to switch on the steam room, press again to switch it off. The steam room will shut down in 60 minutes automatically. (As picture1)



As picture1

2).Steam key

Press The steam generator starts working. The temperature will be shown on the control panel like the picture 2.



As picture2

3).Time adjusting

After the steam function is turned on, press will increase the setting time. When press the more than 1 second, the setting time will be increased continuously until you stop pressing.Or, just when it reaches the maximum limiting time(50 minutes) after that it will return to the minimum limiting time(5 minutes) automatically. Note: The time setting range is between 5-50 minutes. The default time setting is 30 minutes. (As picture3)



As picture3

4).Temperature adjusting key

After steam function is turned on, press will increase the temperature. When press more than 1 second, the setting temperature will be increased continuously until you stop pressing Or,just when it reaches the maximum limiting temperature that it will return to the minimum limiting temperature automatically. Note:The temperature setting range is between 20 °C-50°C.The controlled temperature tolerance: $\pm 3^{\circ}\text{C}$ The default temperature is 40°C.



As picture4

5).Ventilator key

Press to turn on the ventilator , press again to turn off the ventilator.



As picture5

6).Color light key

Press to turn on the color light. After the color light is turned on, each more press will change the different colors of the light. The color light works in this sequence: Turn on, blue ---blue and red ---red----red and orange---orange ---orange and blue---blue---circulating---turn off.



As picture6

7).lamp key

Press the key to turn on the lamp, press again and turn it off. (As picture 6)

8).Radio key

Press to turn on the radio, press again to turn off the radio.(As picture 7)



As picture7

9).Channel memory key

Press and release within 1 second, the frequency of current channel will be changed; Press and hold it more than 1 second, the frequency of current channel will be saved.It can memory total 8 channels.

F8 control panel key and operation instructio

10).Select key

This key gets double functions. When the radio is turned on, this key shows the Frequency function.Press the key and it can be switched from the frequency to the volume function. Press the key, on the Displayer will show like the (Picture 10) or (picture 9). (Picture 9) is for volume and (picture 10) is for frequency.



As picture8

11).Volume up key

After the radio is turned on (As picture9), press will increase the volume. Hold on the key more than 1 second, volume will keep increasing until the key is released. When(picture10) shows on the displayer, press will increase the frequency.Hold on the key more than 1 second, the frequency will keep increasing until the key is released.



As picture9

12).Volume down key

After the radio is turned on, when (Picture 9) is shown on the displayer, press will decrease the volume. Hold on the key more than 1 second, volume will keep decreasing until the key is released. When (picture10) is shown on the displayer,press will decrease the frequency.Hold on the key more than 1 second, the frequency will keep decreasing until the key is released.



As pictur10

User's manual for cleaning the steem generator

Using steps: Turn off the power first, and then open the lid of cleaning cup, put the cleaning liquid in the cleaning cup, after that, cover the lid back. Now turn on the power, start the steam function to make the self-cleaning function work, later turn off the power, and pipe water away.

1).Power off

For safety, it is strictly prohibited to open the lid of the easy cleaning cup during using. In order to avoid steam gas emits out and scald users, please shut down all other functions before using the steam generator  cleaning function. (As picture 11)

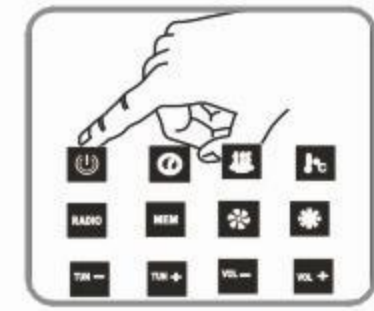

As picture 11

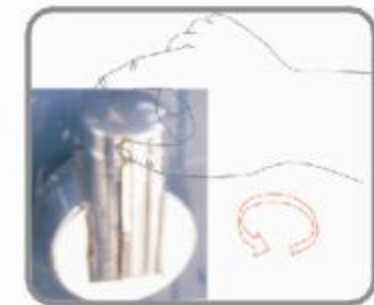

As picture 12



As picture 13

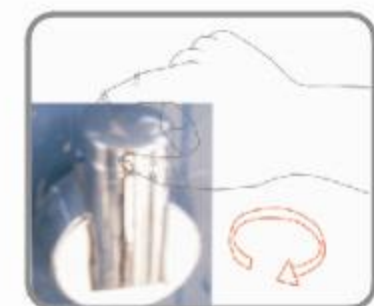

As picture 14

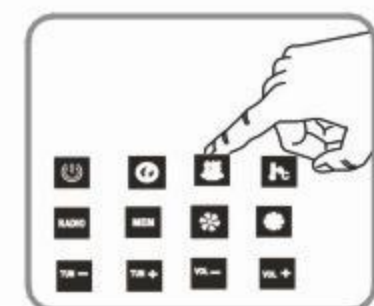

As picture 15



As picture 16

2).Open the easy cleaning cup

After Making sure all of functions are turned off, find out the cleaning cup according the right picture illustrated, and rotate the lid of the cleaning cup to the reverse direction, and then take the lid out slightly. (As picture12)



3).put the cleaning liquid

After opening the cleaning cup, use a spoon to take a proper amount of cleaning liquid, such as Citric acid, or neutral compound cleaning liquid (around 5 ml) to put in the cleaning cup. Note: If the cleaning material is solid, first, please dissolve it with water to prevent blocking. Strictly prohibit to use any other acid, alkaline compounds to be poured into the cleaning cup directly (As picture13).



4).Cover the lid

After adding the cleaning liquid, cover the lid back and turn it in clockwise direction to fasten, like this can prevent the steam emitting out to scald users (As picture14).

5).Turn on and start the steam function

After covering the lid, press  to turn on the steam generator function, and the system  will begin to clean the steam box automatically. (As picture15)

6).Turn off the power and drain out the waste water

After 5-10 minutes, press the  to turn off the steam generator, then press the , the waste water will be drained out automatically (As picture16).

Notice:

1. Strictly prohibit to use the cleaning function while any other function is on;
2. Strictly prohibit to use any other alkaline cleaning compound to clean steam generator;
3. Strictly prohibit to use any solid cleaning agent to clean steam generator, in order to avoid blocking the pipe.

We recommend that you use citric acid solution to clean steam generator!

Maintenance service card

Item number			
Serial number		Purchasing date	
Phone number			

Eago guarantees to keep:

Eago series' products in good repair against the maintenance service card and purchasing receipt since the purchasing date. If it is the product quality problem, it will be free maintenance or change the spare parts. If the problem is not caused by the products itself or over-exceed the one-year guarantee, it will charge the repairing fees and spare parts costs.

The first page is kept for the customer.

Maintenance service card

Item number	
Serial number	
Customer name	
Phone number	
Address	
Agent shop	
Phone number	
Purchasing date	

The second page is sent back to eago head office.

Maintenance service card	
Item number	
Serial number	
Customer name	
Phone number	
Address	
Agent shop	
Phone number	
Purchasing date	

Steam shower room trouble shooting

Malfunction Status	Reasons	Solutions
Small volume inlet water	<ol style="list-style-type: none"> 1. Lower inlet water pressure 2. The water inlet pipe is blocked 	<ol style="list-style-type: none"> 1. Check the inlet water pressure, then check with local plumber 2. Clean the filtre
Water divert valve can't divert water	<ol style="list-style-type: none"> 1. Rubber inside the valve damaged or distorted 	<ol style="list-style-type: none"> 1. Change a new one
No signal on the control panel	<ol style="list-style-type: none"> 1. There is no power in the user's house or the wire not connected well 2. Not switch the power on 3. The connecting wire for the control panel becomes loose 	<ol style="list-style-type: none"> 1. Need to wait the power on, connect wires in right way 2. Swtich on the power 3. Take it off and install it again, don't forget fasten it
There is steam signal on the control panle, but no steam comes out	<ol style="list-style-type: none"> 1. The Temperature limiter operate or the heater is broken 	<ol style="list-style-type: none"> 1. Ask help to qualified people
Chromatherapy light doesn't work	<ol style="list-style-type: none"> 1. The connecting wire blew out or the lamp holder loosen 2. Lamp pannel is broken 	<ol style="list-style-type: none"> 1. Change a new one or install it well again 2. Change a new one
Ventilator doesn't work	<ol style="list-style-type: none"> 1. The connecting wire is off 2. The fan blade gets stuck 3. The ventilation fan is broken 	<ol style="list-style-type: none"> 1. Reconnect it well 2. When the fan is on spur the blades slightly 3. Change a new one