

USER MANUAL

KBU-50 / 100 / 170WX SINGLE ZONE WINE REFRIGERATORS



KBU50WX-FG

KBU100WX-FG

KBU170WX-FG

KBU170WX

KBU100WX

KBU50WX

BORDERLESS BLACK GLASS DOOR SERIES

GLASS DOOR WITH STAINLESS TRIM SERIES

(Note: The model number in Australia is KB instead of KBU)

PLEASE NOTE:

Every time the unit is powered ON, there will be a 6-minute delay for the compressor to start.

COMPRESSOR WINE REFRIGERATORS

CONTENTS

Congratulations

Congratulations and thank you for choosing our KingsBottle wine coolers. We are sure you will find your new appliance a pleasure to use. Before installing and operating the wine cooler, we recommend that you read through this manual which provides a description of your wine cooler and its functions.

To avoid the risks that are always present when you use an electric appliance, it is important that the appliance is installed correctly and that you read the safety instructions carefully to avoid misuse and hazards.

We recommend that you keep this instruction booklet for future reference and pass it on to any future owners.

After unpacking the appliance, please inspect it to verify it is not damaged. If in doubt, do not use the appliance but contact us or your local customer care center.

TABLE OF CONTENTS

Chapter	Contents	Page
Part I	Important Safety & Pre-Use Instructions	3
Part II	Diagram & Description of Refrigerator	4
Part III	Installation Instructions	5-7
Part IV	Layout & Storage	8-10
Part V	Temperature Setting and Operating the Refrigerator	11
PART VI	Troubleshooting Guide	12-14
Part VII	Maintenance Guide	15
Part VIII	Technical Data	16
Part IX	Warranty Information	16

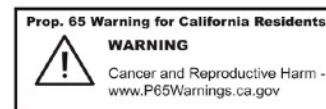

DISCLAIMER

The manufacturer accepts no liability for any spoilage to the content of the refrigerator, not even when the device is within the warranty period. Similarly, the manufacturer accepts no liability for personal injury due to incorrectly stored goods, which are for personal consumption or resale.

COMPRESSOR WINE REFRIGERATORS

PART I IMPORTANT SAFETY INSTRUCTIONS

Please read this user manual carefully and store in a handy place for later reference. The symbols you will see in this booklet have these meanings:



WARNING

This symbol indicates information concerning your personal safety



CAUTION

This symbol indicates information on how to avoid damaging the appliance



TIPS & INFORMATION

This symbol indicates tips and information about the use of the appliance



ENVIRONMENTAL TIPS

This symbol indicates tips and information about economical and ecological use of the appliance



WARNING

TO REDUCE THE RISK OF FIRE, ELECTRICAL SHOCK, OR INJURY WHEN USING YOUR APPLIANCE, FOLLOW THESE BASIC PRECAUTIONS:

1. Read all instructions before using the wine cooler.
 2. DANGER or WARNING: Risk of child entrapment. Child entrapment and suffocation pose a serious problem and children should not be let near the appliance unsupervised. Junked or abandoned appliances are still dangerous... even if they will "just sit in the garage for a few days."
 3. Before you throw away your old wine cooler:
 - Take off the door.
 - Dismantle the Shelves into pieces so that children may not climb inside easily.
 4. Never allow children to operate, play with, or crawl inside the appliance.
1. The wine cooler must be plugged into its dedicated 110/115V, 60Hz AC electrical outlet.
(Note: 220/240V, 50 Hz in Australia)
 2. The plug must be accessible when the cooler is in position.
 3. It is essential that the power point is properly grounded. Consult a qualified electrician if you are unsure.
 4. Don't use extension cords or adapter plugs with this cooler.
 5. If the power cord is damaged, have it replaced by a qualified service technician.
 6. Unplug the cooler before cleaning it, or changing the light bulb to avoid electric shock.
 7. Never clean appliance parts with flammable fluids. The fumes can create a fire hazard or explosion.
 8. Never unplug the cooler by pulling the electrical cord as this may damage it. Grip the plug firmly and pull straight out.
 9. Choose a location for your cooler that isn't too cold. The ambient room temperature should be above 50° F.
 10. Stand your cooler in a dry place – avoid areas of high moisture or humidity.
 11. Don't put the cooler in frosty or unprotected areas like a garage or on the verandah.
 12. Keep the cooler out of direct sunlight.
 13. Don't locate the cooler near stoves, fires or heaters.
 14. Do not store in the vicinity of any other appliance. Do not store near gasoline or any other flammable vapors. The fumes can create an explosion or lead to a fire hazard.
 15. When installed correctly, your cooler should:
 16. Have adequate space at the back and sides for air circulation. (See Page 5)
 17. Be aligned to the surrounding cupboards.
 18. Have doors that will self-close from a partially open position
 19. Please inspect and clean the filter in front venting grill every month. Failure to clean will void the warranty and increase the running costs.

BEFORE USING YOUR WINE COOLER

- Remove the exterior and interior packing.
- Before connecting the wine cooler to the power source, let it stand upright for approximately 24 hours. This will reduce the possibility of a malfunction in the cooling system from handling during transportation.
- Clean the interior surface with lukewarm water using a soft cloth.

FEATURES

PART II DIAGRAM & DESCRIPTION OF REFRIGERATOR

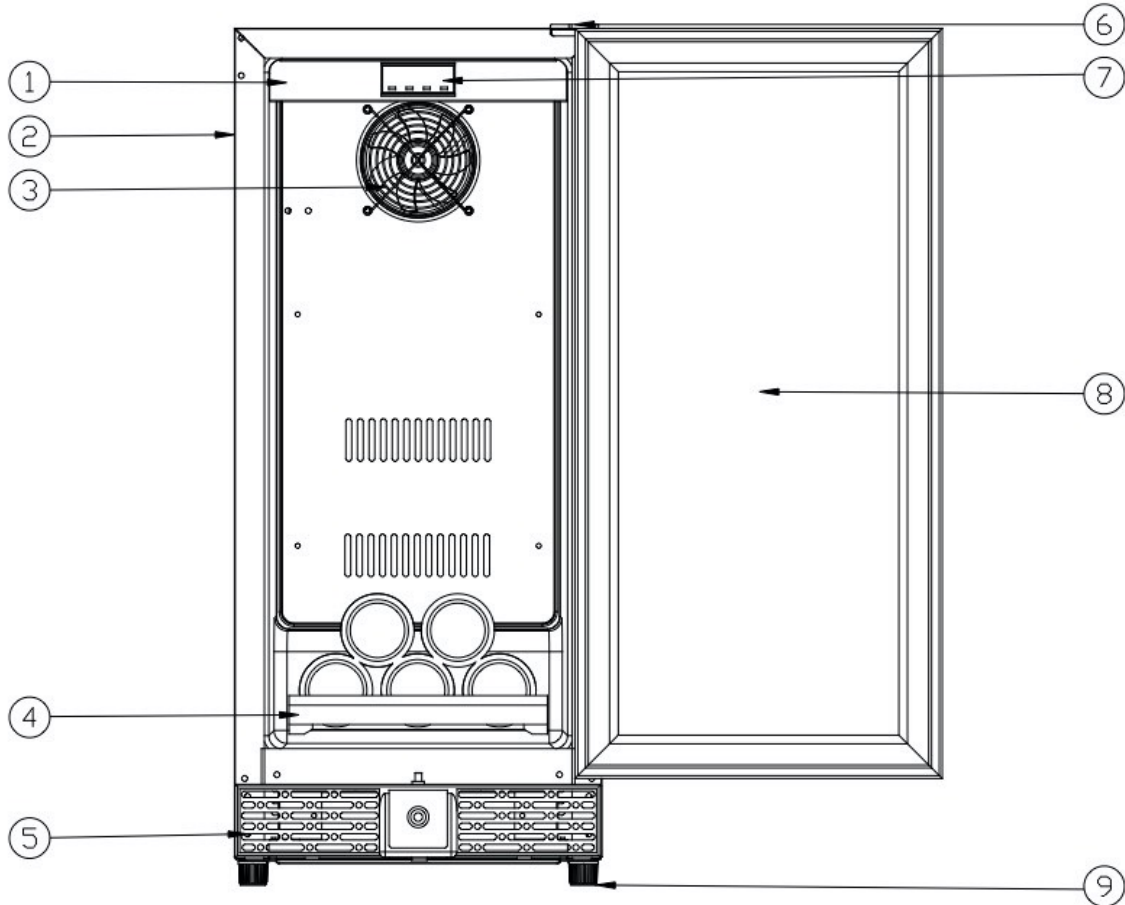

- 1 Control board
- 2 Housing
- 3 Ventilation DC Fan

- 4 Shelf
- 5 Front grill
- 6 Door hinge

- 7 Controller
- 8 Door
- 9 Adjustable stand feet

YOUR WINE COOLER ALSO INCLUDES THE FOLLOWING:

- Instruction manual
- Two keys
- Top and bottom hinges , also screws for changing the door hinge

COMPRESSOR WINE REFRIGERATORS

INSTALLATION

PART III INSTALLATION INSTRUCTIONS

CUTOUT DIMENSION ILLUSTRATED

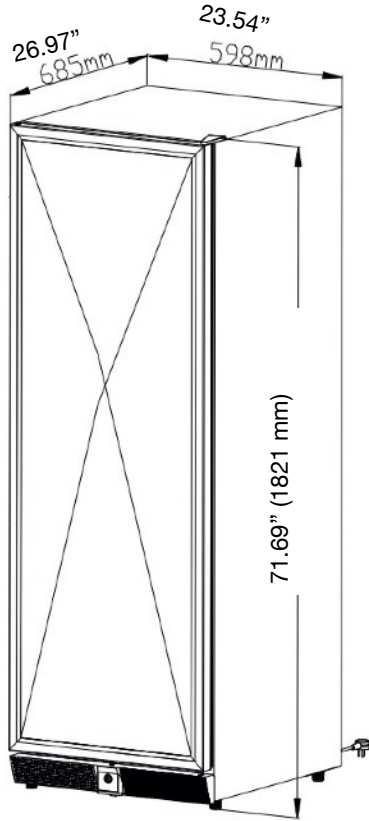

KBU-170 SERIES

23.54"W x 26.97"D x 71.69"H
(598W x 685D x 1821H mm)
Included stand height 0.98"(25mm)

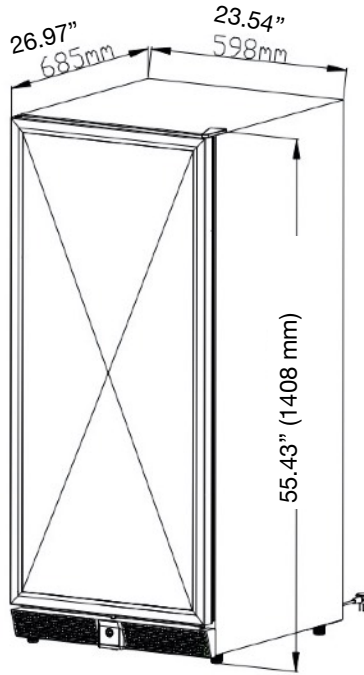

KBU-100 SERIES

23.54"W x 26.97"D x 55.43"H
(598W x 685D x 1408H mm)
Included stand height 0.98"(25mm)

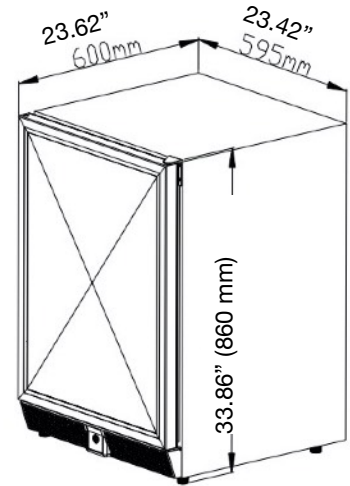

KBU-50 SERIES

23.42"W x 23.62"D x 33.86"H
(595W x 600D x 860H mm)
Included stand height 0.79" (20mm)

MODEL	WIDTH	DEPTH	HEIGHT	INCLUDED STAND HEIGHT	NOTE
KBU-50	23.42" 595mm	23.62" 600mm	33.86" 860mm	0.79" 20mm	These front-venting models can be built into cabinetry. Should it be built into cabinetry, there should be an additional 0.5" (20mm) on either side, behind and on top of the unit. These extra spaces enable units to be placed in the position efficiently, accommodate the door when opened, and without the power cords being damaged.
KBU-100	23.54" 598mm	26.97" 685mm	55.43" 1408mm	0.98" 25mm	
KBU-170	23.54" 598mm	26.97" 685mm	71.69" 1821mm	0.98" 25mm	

INSTALLATION

PART III INSTALLATION INSTRUCTIONS

INSTALLING YOUR WINE COOLER

1. Move the unit into its final position. (CAUTION: for safety purpose, for the KBU100 and KBU170 models, it is necessary to anchor the appliances to the wall, please refer to the instruction on the next page.)
2. If the unit is not tilting back, minor adjustments can be made to the leveling legs.
3. Compare the alignment of the appliance to the surrounding cupboard. The top of the appliance should be level side to side (see diagram below).

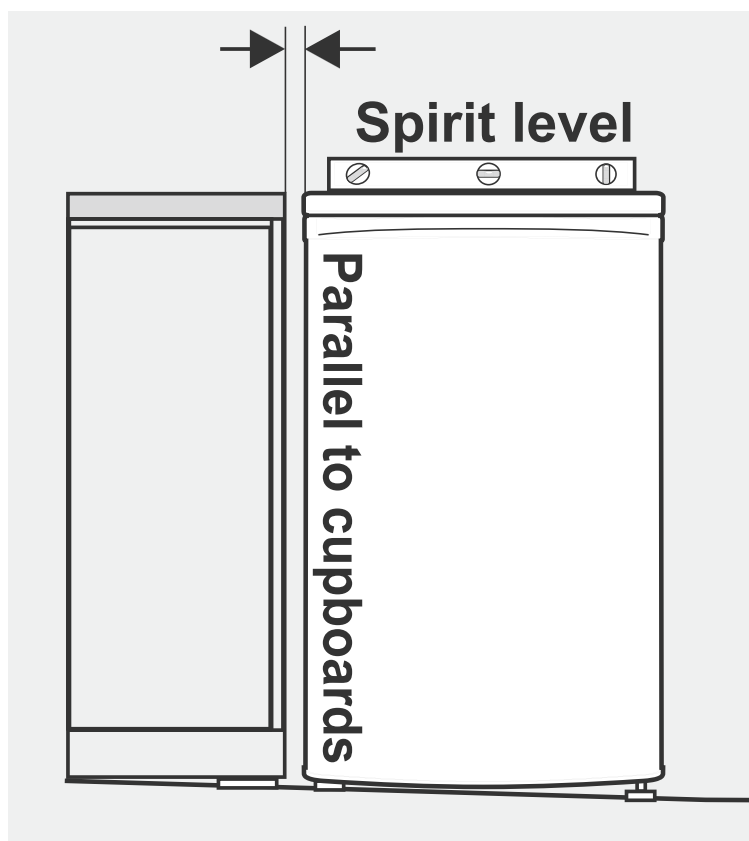

4. If the unit now rocks from one corner to the opposite rear corner, this means that the floor is uneven. You may need to put some packing under the ridge to the rear of the appliance. You could use thin pieces of a solid material such as a thin board, vinyl floor tiles or laminate.
5. You may now need to fine tune the installation by repeating steps 2, 3 and 4.
6. Wipe off any dust that has accumulated during shipping and clean following the directions in Part VI (Care & Maintenance)
7. Plug the appliance into the power point. Don't use a double adaptor or extension cord.
8. It is recommended that you allow the unit to rest an hour or two before you put any wine bottles in it. This will confirm that it is operating correctly and make the conditions appropriate for wine storage.

Congratulations! You have successfully installed your wine cooler.

DOOR LOCK

This unit comes with an optional key lock. The keys are located inside the plastic bag that contains the user manual. To lock the door, simply insert the key into the lock and turn clockwise making sure the metal pin is engaged completely. Then remove the key and place it in a secure place for safekeeping. To unlock the door, insert the key into the lock and turn counterclockwise.

COMPRESSOR WINE REFRIGERATORS

INSTALLATION

Instructions to Anchor The Appliance to The Wall

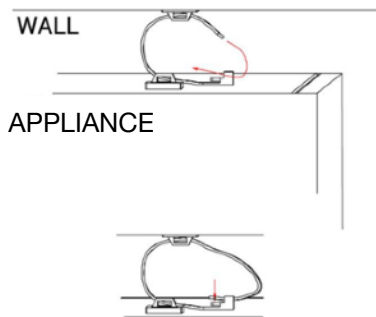
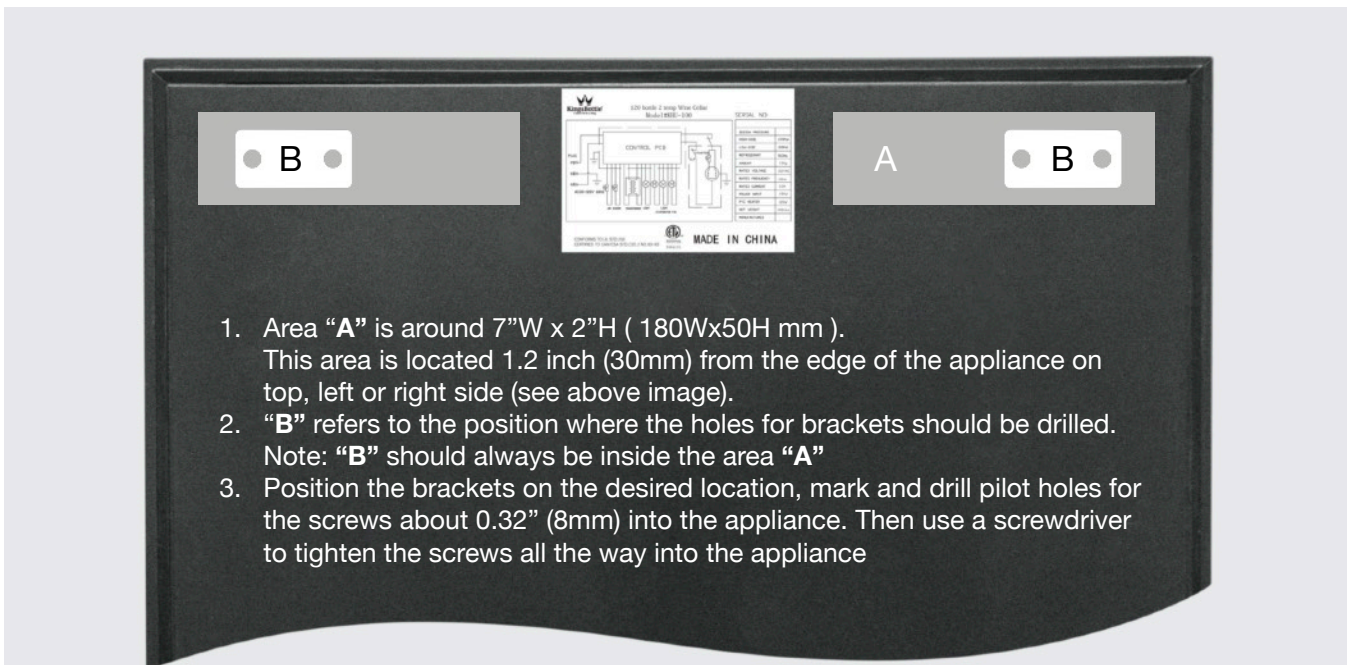
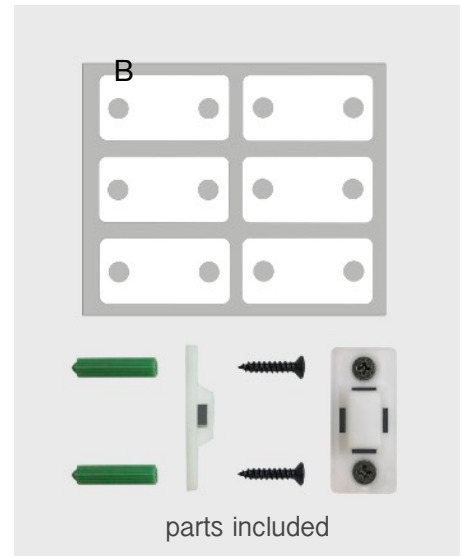

Position the appliance in the desired location. Locate wall studs behind the appliance and mark the location where the bracket lines up with a stud on the back of the appliance. Move the appliance away from the wall and position bracket on the mark. Mark and drill pilot holes into the center of the stud with a 3/32" (2.5mm) drill bit. Attach a bracket to the stud with the long screws provided.

Move the appliance into its final position, taking care to line up the wall bracket close enough to the bracket on the back of the appliance to strap them together. Thread a strap through the brackets as shown in the illustration. Tighten the straps until snug. Do not over tighten.

CAUTION: These instructions are not intended to be a substitute for proper supervision. The manufacturer assumes no liability for improper installation or excessive loads placed on screws, brackets, or straps.

Straps should be periodically adjusted, tested and replaced.

STORAGE

PART IV LAYOUT AND STORAGE

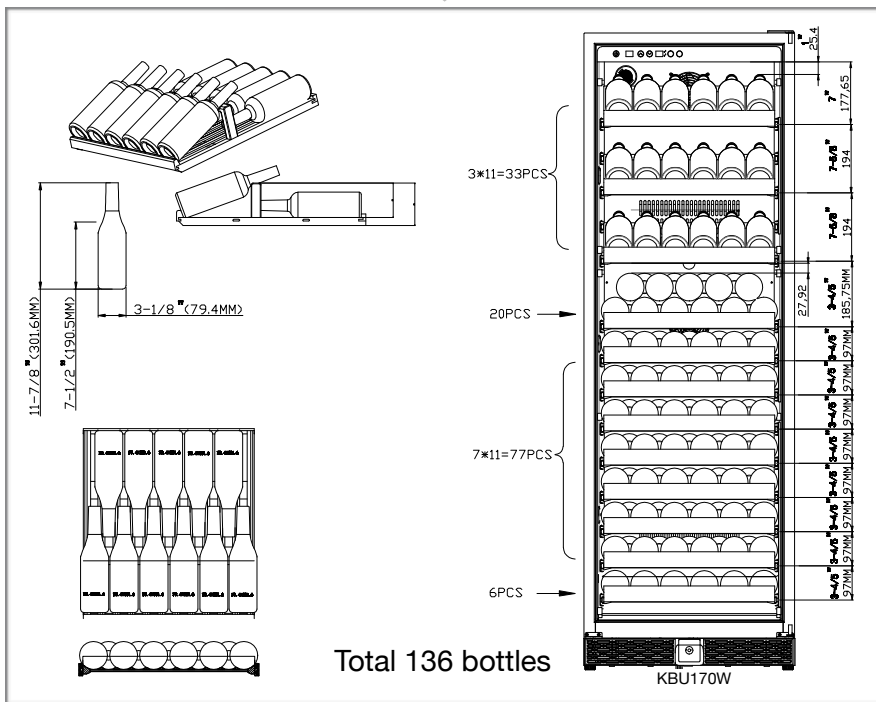
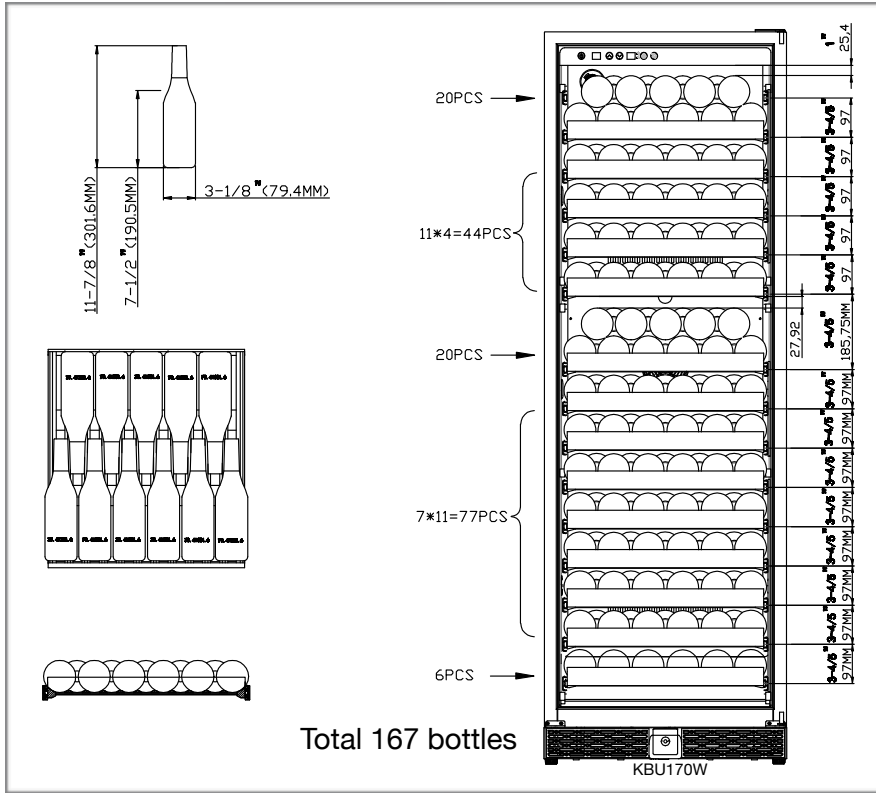

display shelves options

(for KBU170W Models)

As an additional option, you might like the idea to have some display shelves to show your bottle label. You could refer to the instruction to remove the 2nd, 4th shelves at the top (*use the screws to fill the holes on the wall after shelves removed*), and then change the 1st, 3rd, 5th shelves to display shelves.

Note:

This changes will reduce the total storage capacity.

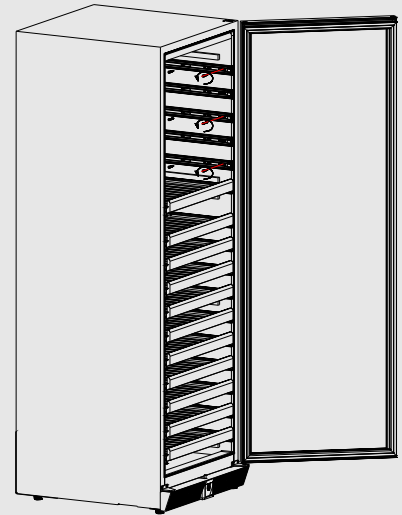

remove the 2nd, 4th shelves

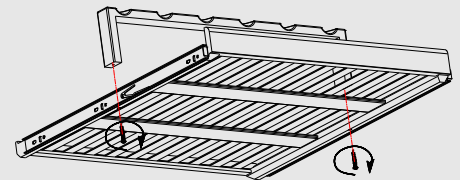

change the 1st, 3rd, 5th standard shelves to display shelves

STORAGE

PART IV

LAYOUT AND STORAGE

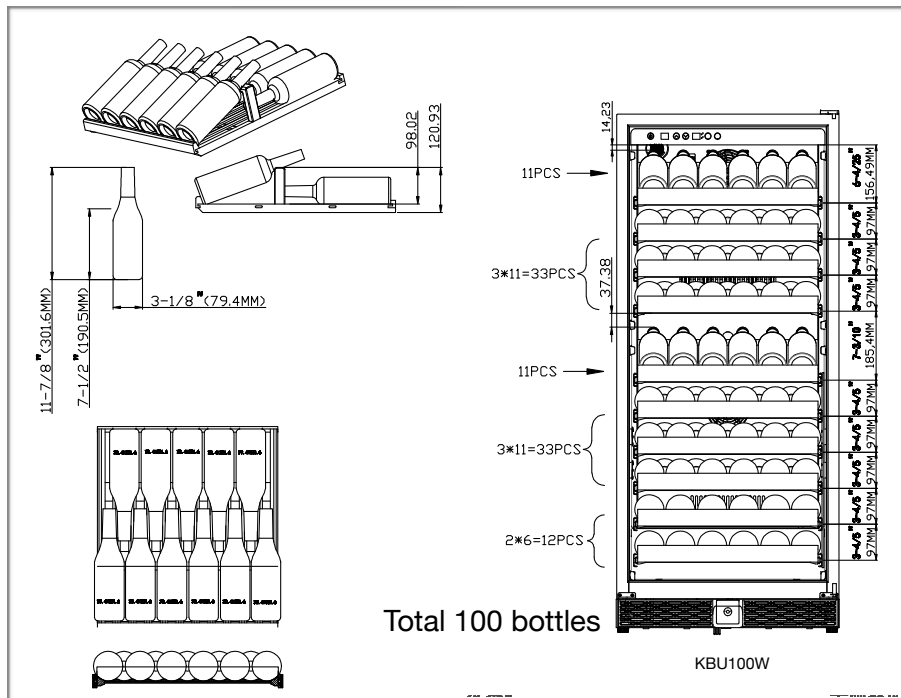
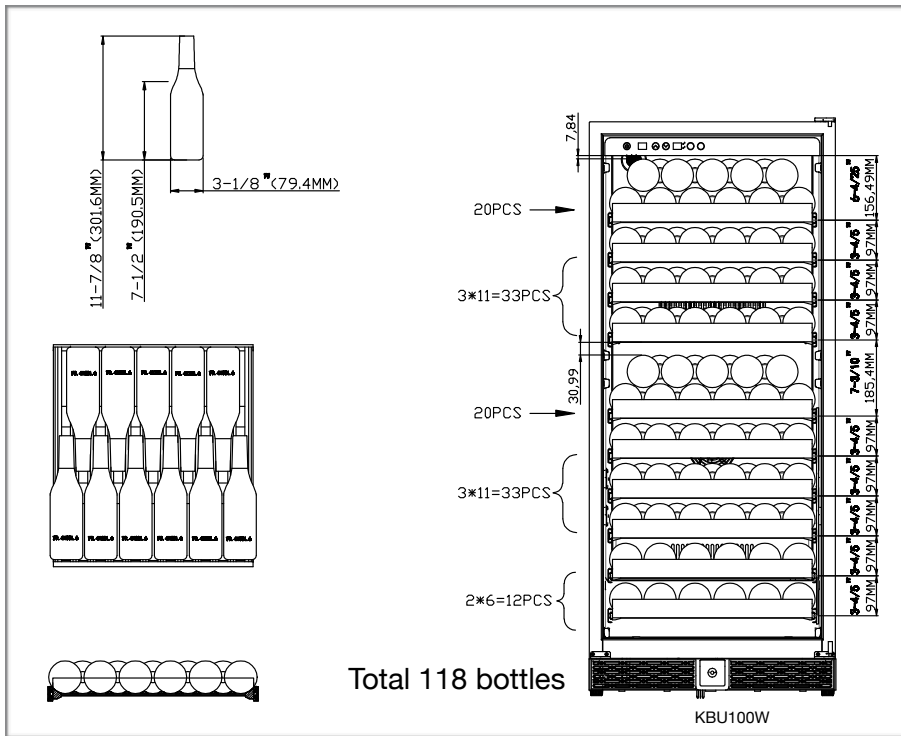

display shelves options

(for KBU100W Models)

As an additional option, you might like the idea to have some display shelves to show your bottle label. You could refer to the instruction to remove the 2nd shelf at the top (use the screws to fill the holes on the wall after shelves removed), and then change the 1st, 3rd shelves to display shelves.

Note:

This changes will reduce the total storage capacity.



remove the 2nd shelf

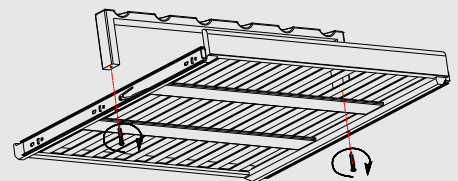

change the 1st, 3rd standard shelves to display shelves

STORAGE

PART IV

LAYOUT AND STORAGE

YOUR CABINET WAS DESIGNED TO STORE A MAXIMUM NUMBER OF BOTTLES SECURELY. WE RECOMMEND THAT YOU OBSERVE THE TIPS BELOW TO OPTIMIZE LOADING.

1. Disperse your bottles evenly so as not to concentrate the weight in any one area. Also, be careful that your bottles do not touch either the back of the cabinet or the step at the bottom.
2. Also, make sure that bottles are not all grouped together either at the top or bottom of the cabinet.
3. A cooler that is full and has a nice allowance for air movement will work more efficiently.
4. Never try to adjust shelf with bottles still on it.

TO REMOVE A ROLLING SHELF:

1. Remove all bottles
2. Pull the shelf out as far as possible
3. Push the LEFT side lever downward but the RIGHT side lever upward (as illustrated below)
4. Remove the shelf

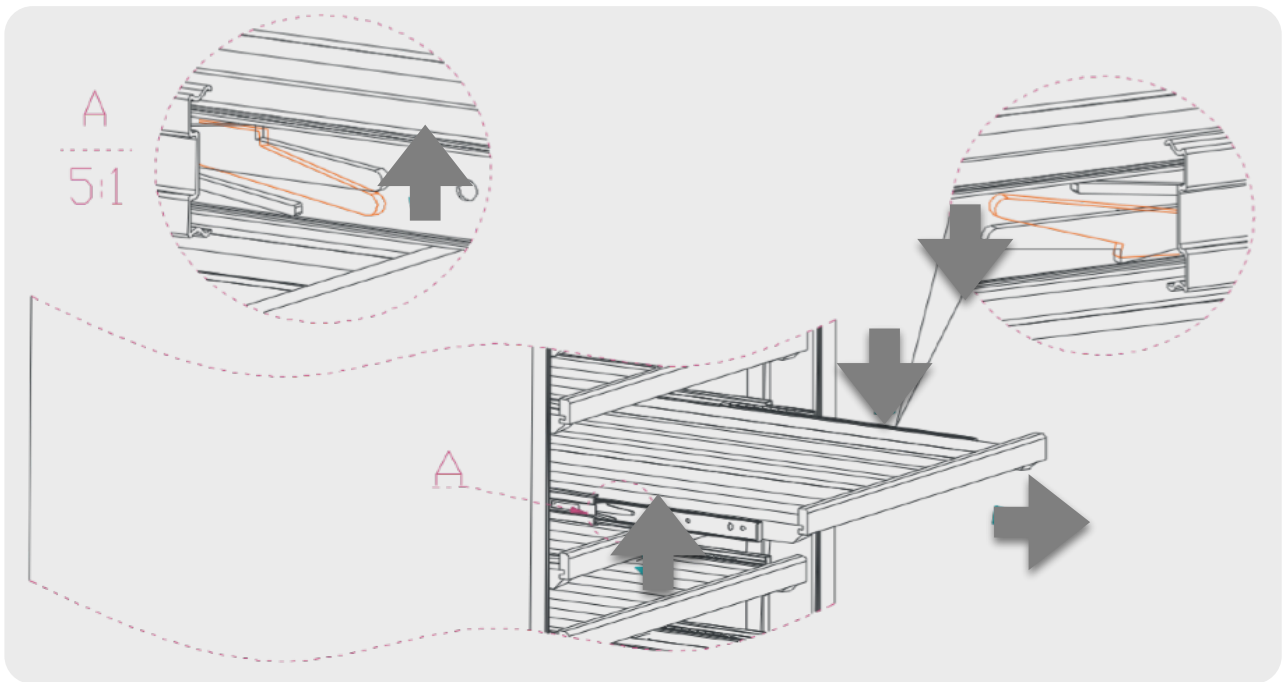

PLEASE NOTE

Before modifying your cabinet's original configuration in any way, be sure to ask your dealer for advice.

COMPRESSOR WINE REFRIGERATORS

PART V OPERATING YOUR REFRIGERATOR

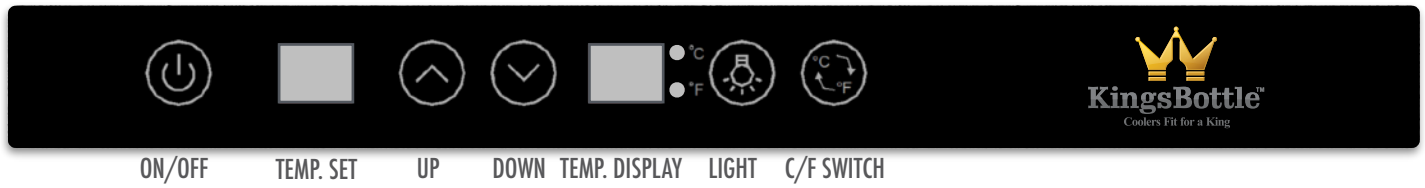

Each wine cooler includes an operating panel on the front of the unit. This operating panel includes several features to operate and control the temperature, light color and brightness.

ON/OFF: Turns the wine cooler power on or off.

TEMP. SET: Displays the desired temperature.

TEMP. DISPLAY: Displays the actual temperature.

UP / DOWN: Adjust the temperature preset value.

LIGHT: Turns the interior light on/off, or change the light colors.

LIGHT+UP: Increase the light brightness; **LIGHT+DOWN:** Decrease the light brightness.

C/F SWITCH: Switch between °C and °F

LIGHT ON/OFF, COLOR & BRIGHTNESS CONTROL

1. Press the **LIGHT** button to turn the light on/off, or change the light color. The order of change is as follows: ON, red, orange, yellow, green, blue, purple, white, color changing, OFF.

2. While holding down the **LIGHT** button, press the **UP** button to increase the brightness, or press the **DOWN** button to decrease the light brightness. Brightness is divided into 5 levels: 20%, 40%, 60%, 80% and 100%.

SETTING THE TEMPERATURE CONTROL

1. Make sure the power cord is connected to a properly grounded outlet.
2. Press the **ON/OFF** button to turn the power ON.
3. Press the **C/F SWITCH** button to choose and display Fahrenheit or Celsius temperature.
4. Set the temperature as you desire by pushing the **UP** or **DOWN** button.

NOTE: The desired temperatures may fluctuate depending on whether the interior light is ON or OFF, the ambient temperature, the location of the unit and the orientation of the bottles. The display is just a guide, be guided by how cold your drinks are at consumption. Remember units go into defrost mode, and this will show a higher display, it's only for short periods and doesn't have time to affect drink temperature. In general, once the unit has settled, it will keep products within 5°F (2°C) of the set temp easily in temperatures up to and beyond 100°F (38°C).

TEMPERATURE SETTINGS FOR WINE SERVICE

Different varietals of wine require different temperature settings. The recommended temperature ranges for long term preservation of various wines is Red Wines: 52-64°F (11-18°C); White Wines: 44-51°F (7-10°C); Sparkle Wines: 41-43°F (5-6°C).

CAUTION

1. In the event of a power interruption, all previous temperature settings will be automatically saved and each compartment will return to the previous temperature setting.
2. If the unit is unplugged, loses power, or is turned off, there will be a 6 minute delay for the compressor to restart after the unit is powered ON.
3. When you use the wine cooler for the first time or restart the wine cooler after having been shut off for a long time, there will be a few degrees variance between the temperature you select and the one indicated on the LED readout for the first few hours of operation. After a few hours of operation, the temperature will normalize to the displayed temperature.

TROUBLESHOOTING GUIDE

PART VI TROUBLESHOOTING GUIDE

PROBLEM	POSSIBLE CAUSE	SOLUTION
1. Refrigerator does not operate	1. Not plugged in	1. Press ON/OFF
	2. The appliance is turned OFF at the control panel	2. Check and make sure the power plug is well connected
	3. The power outlet is powered off or the output voltage is too low	3. Ask a technician to check whether the power outlet has an accurate voltage output
	4. The circuit breaker has tripped, or a fuse has blown out	4. Ask an technician for help
2. Refrigerator is not cold enough; can not cool down to the preset temp.	The compressor does not start	ask a technician for help / check the connection of the compressor
	The ambient temperature is too high (over 100°F 38°C)	Move the refrigerator to a cool and ventilated place
	Place too many bottles at once	Put in the bottles in batches. It is recommended not to exceed 1/3 of full load at a time. After the temperature in the cabinet drops to the set temperature, store the next batch.
	The inlet and outlet of the front grille are blocked.	Remove objects that may block the air inlet and outlet
	The door is not closed tightly, or the door gasket is not properly sealed.	Please refer to the problem #6 "The door will not close properly" and its solutions. Then unplug the power plug for 5 hours, wait for the ice on the evaporator melt, restart the refrigerator.
	The door opening time is too long or too frequent	Reduce the times/frequency of door openings.
	There are other objects besides drink bottles in the cabinet, which affects the air circulation.	This refrigerator is designed for wine storage, if there are other objects, please remove it. The number of bottles placed on each layer cannot exceed the standard configuration.
	If the refrigerator is placed outdoors or in a place with a lot of dust/oil stains, after a period of time, a large amount of dust will accumulate on the condenser fins, which will affect the cooling effect.	Move the refrigerator to a place with less dust, regularly check the dust accumulation status, and clean it with a blower.
	Fans (condenser fan or evaporator fan) stop working or operate at low speed	Ask the technician to check whether there is a standard voltage on the fan terminal when turning on the power. If the voltage is abnormal, please check the switching power supply or the motherboard or circuit failure. If the voltage is normal, the fan may be damaged, please replace with a new fan.
	The compressor or its accessories are damaged	Turn off the power and ask the technician to diagnose.
3. Compressor starts and stops frequently	The door is not closed tightly.	Please refer to the problem #6 "The door will not close properly" and its solutions. Then unplug the power plug for 5 hours, wait for the ice on the evaporator melt, restart the refrigerator.
	The door gasket is not properly sealed.	1. Use low heat on a hairdryer to make the door seal take shape. 2. Replace with a new door gasket.
	The door is opened too often.	Reduce the times/frequency of door openings.
	The ambient temperature is too high (over 100°F 38°C)	Move the refrigerator to a cool and ventilated place
	Improper setting of temperature and the temperature variances	Properly increase the temperature and its variances
	The temperature sensor is not connected correctly.	Read the wiring diagram to make the correct connection of the sensor.
	The sensor is faulty.	Replace with a new sensor
4. The light does not work.	Not plugged in, or the light button is "OFF." Not enough brightness.	1. Adjust the brightness of the lamp according to the operating instructions.
	The light itself is faulty.	2. Replace with new bulb; the lamp has its polarity.
	PCB circuit faulty.	3. Find a technician to repair.

TROUBLESHOOTING GUIDE

PART VI TROUBLESHOOTING GUIDE

PROBLEM	POSSIBLE CAUSE	SOLUTION
5. The Refrigerator seems to make too much noise.	No standing hours before connecting the refrigerator to the power source.	Turn off the power and let it stand for hours.
	The stand feet is not leveling; vibrations lead to noise	Adjust the stand feet and ensure they are leveled.
	The floor is not stable enough	Move to a solid and stable floor
	Hot and cold contraction sounds of the inner tank and other plastics	No action required. It will gradually disappear.
	Copper pipe hits other objects and makes noise	Gently adjust the position of the pipe.
	The vibration of internal moving parts caused by inertia when the compressor is stopped or started	It's normal, no action required.
	A liquid plumbing noise may come from the flow of the refrigerators gases	As each cycle ends, you may hear gurgling sounds. It's normal, no action required.
	Vibration of cooling copper pipes or fans hit other objects	Open the back cover of the refrigerator, and properly adjust the copper pipes and wires so that they will not hit or resonate with other objects.
	Compressor or fan itself failure	Find a technician to repair.
6. The door will not close properly.	Door is blocked by the non-standard size bottles	Adjust the position of bottles, or the number of shelves appropriately
	The hinges of the upper and lower doors are loose	Adjust and fix the door hinge
	The door sealing rubber is deformed	1. Use low heat on a hairdryer to make the door seal take shape. 2. Replace with a new door gasket.
	The door body is deformed	Replace with a new door
7. Evaporator ice up	The door is not closed tightly, or the door gasket is not properly sealed.	Please refer to the problem #6 "The door will not close properly" and its solutions. Then unplug the power plug for 5 hours, wait for the ice on the evaporator melt, restart the refrigerator.
	Poor cooling performance. The fridge does not cool or can not reach the preset temperature value.	Please refer to the problem #2 "Refrigerator is not cold enough; can not cool down to the preset temp." and the corresponding solutions. Then unplug the power plug for 5 hours, wait for the ice on the evaporator melt, restart the refrigerator.
	The compressor never stops even if the refrigerator cools and reaches the preset temperature value	The controller (PCB board) or temperature sensor is faulty, please ask a technician to repair.
8. External cabinet seems too hot	The ambient temperature is too high (over 100°F 38°C)	Move the refrigerator to a cool and ventilated place
	The inlet and outlet of the front grille are blocked.	Remove objects that may block the air inlet and outlet
	If the refrigerator is placed outdoors or in a place with a lot of dust/oil stains, after a period of time, a large amount of dust will accumulate on the condenser fins, which will affect the cooling effect.	Move the refrigerator to a place with less dust, regularly check the dust accumulation status, and clean it with a blower.
	The condenser fan stops working or operates at low speed	Ask the technician to check whether there is a standard voltage on the fan terminal when turning on the power. If the voltage is abnormal, please check the switching power supply or the motherboard or circuit failure. If the voltage is normal, the fan may be damaged, please replace with a new fan.
9. Condensation on the glass door	Ambient humidity is high	Use a soft cloth to wipe dry the water
	The door opening is too frequent	Reduce the frequency of door openings.
	The door does not close properly.	Please refer to the problem #6 "The door will not close properly" and its solutions. Then unplug the power plug for 5 hours, wait for the ice on the evaporator melt, restart the refrigerator.
	The heating glass is OFF (heating glass door is only available for specific models)	Turn on the heating glass
	The heating glass function fails (heating glass door is only available for specific models)	Find a technician to repair, or replace with a new door.

TROUBLESHOOTING GUIDE

PART VI TROUBLESHOOTING GUIDE

PROBLEM	POSSIBLE CAUSE	SOLUTION
10. Water leakage (outside of the cabinet)	Condensation dripping from the glass door to the floor	Please refer to the problem #9 "Condensation on the glass door" and its solutions.
	Water overflows in the water pan next to the compressor	Open the back cover of the compressor and make sure that the water pipe is in the water receiving tray.
11. Water leakage inside the cabinet	The outlet of the water tray below the evaporator is blocked	Remove the blockages
	The water pipe connected to the water tray under the evaporator falls off.	Re-connect the water pipe, glue it with glue and tighten it with cable ties
	The water tray cannot catch all the water drops from the evaporator	Reinstall the water tray.
12. High humidity in the cabinet or condensation on the bottle surface	Ambient humidity is high	Move the refrigerator to a cool and ventilated place
	The door opening time is too long or too frequent	Reduce the times/frequency of door openings.
	The door does not close properly.	Please refer to the problem #6 "The door will not close properly" and its solutions.
13. The temperature difference between the bottles inside the cabinet is large	There are other objects besides drink bottles in the cabinet, which affects the air circulation.	This refrigerator is designed for wine storage, if there are other objects, please remove it. The number of bottles placed on each layer cannot exceed the standard configuration.
	The running time is too short, and the system has not reached a stable state.	No action required. After extending the cooling time, the temperature inside the cabinet will be uniform.
	The upper and lower temperatures are not preset properly. (only applicable to dual-zone wine cabinets)	Adjust the temperature setting value; the best setting is that the preset value in the LOWER zone is 9°F (5°C) higher than the UPPER zone.
14. The power consumption is different from the value on the label	Power consumption is related to many factors, such as ambient temperature, ventilation conditions, the number of bottles in the cabinet, preset temperature, and voltage level. The actual situation may differ from the power consumption indicated on the label. This is normal.	No action required.
15. Incomplete display characters	The number on the display is missing one or two strokes	The wiring of the display is poor connected. In most cases, it will not affect the cooling function of the refrigerator.
	The display is not displayed, but the keys have sound	Find a technician to repair.
16. Button failure	The door opening time is too long, resulting in too much condensation on the glass panel	Avoid opening the door for a long time when the machine is turned on, it will return to normal in ten minutes after the door is closed.
	Signals such as cars, hair dryers, induction cookers, and mobile phones accidentally interfere with the wine cabinet	Keep away from the signal source, turn off and unplug the power, then restart the refrigerator.
17. There is smell inside the cabinet	Display or control board failure.	Find a technician to repair.
	The new machine may leave a small amount of environmental cleaner	No action required, it will disappear gradually.
18. Error code U1, C1, U2 or C2	The smell of wooden shelves	No action required, it will disappear gradually.
	Error code U1 or C1 means the sensor in the UPPER zone is short-circuit or open-circuit.	The sensor in the UPPER zone is defective, or the socket/plug with UP mark on PCB is poor connected. Please check the connection or replace the sensor.
19. Error code HH	Error code U2 or C2 means the sensor in the LOWER zone is short-circuit or open-circuit.	The sensor in the LOWER zone is defective, or the socket/plug with DOWN mark on PCB is poor connected. Please check the connection or replace the sensor.
	High-temperature alarm	Please refer to the problem #2 "Refrigerator is not cold enough; can not cool down to the preset temp." and its solutions. Then unplug the power plug for 5 hours, restart the refrigerator.
20. Error code LL	Low-temperature alarm	1. Unplug the power for 5 hours, restart the refrigerator and check again. 2. Check or replace the sensors and control board. 3. Check or replace the the electromagnetic valve (applicable to KBU28LR)

PART VII CARE AND MAINTENANCE

CLEANING YOUR WINE COOLER



BEFORE CLEANING: Turn off the power, unplug the appliance, and remove all items including all the shelves.

- Wash the inside surfaces with warm water and baking soda solution. The solution should be about 2 tablespoons of baking soda with a quart of water.
- Wash the shelves with a mild detergent solution.
- Wring excess water out of the sponge or cloth when cleaning area of the controls, or any electrical parts.
- Wash the outside cabinet with warm water and a mild liquid detergent. Rinse well and wipe dry with a clean, soft cloth.
- After installation, we recommend that owners apply a thin layer of Olive Oil with a clean rag, to all exposed Stainless Steel areas. This should then be polished in and buffed off with another clean rag to a non-oily finish. This process will aid protection against dirt and other corrosive contaminants, by providing a temporary food-safe shield. The Olive Oil layer also makes later polishing and removal of fingerprints easier. This process should be repeated frequently every 3-4 months. ALL stainless steel can rust; it is a myth that stainless steel doesn't rust.

POWER FAILURE

Most power failures are corrected within a few hours and should not affect the temperature of your appliance if you minimize the number of times the door is opened. If the power is going to be off for a longer period of time, you need to take the proper steps to protect your contents.

VACATION TIME

Short vacations: You may leave the wine cooler operating during vacations of less than three weeks.

Long vacations: If the appliance will not be used for several months, remove all items and turn off the appliance. Clean and dry the interior thoroughly. To prevent mold growth, leave the door open slightly, blocking it open if necessary.

MOVING YOUR WINE COOLER

1. Remove all items.
2. Securely tape down all loose items (shelves) inside your appliance.
3. Turn the adjustable leg up to the base to avoid damage.
4. Tape the door shut.
5. Be sure the appliance stays secure in the upright position during transportation. Also, protect the outside of the appliance with a blanket or similar item.

ENERGY SAVING TIPS

- The wine cooler should be located in the coolest area of the room, away from heat-producing appliances, and away from direct sunlight. Ventilation at the rear also helps a lot with energy usage, to create a positive air flow where possible, although with this range they are designed to be fully built in.
- When you are not using cooler during weekdays etc. it is recommended to set the temp at a higher level, so set at 64°F (18°C) during periods of non-usage, this will not only mean less run time, it will also keep drinks at a temp that won't get them spoiled. It saves energy also which these days are a growing concern for most households.
- Keep the cooler stocked; an empty cooler will run longer, believe it or not.

PART VIII TECHNICAL DATA

MODEL NO.	KBU170WX	KBU100WX	KBU50WX
VOLUME	14.30 CF (405 Liter)	10.88 CF (308 Liter)	5.37 CF (152 Liter)
TYPE OF COOLING	compressor with air-circulated fan cooling	compressor with air-circulated fan cooling	compressor with air-circulated fan cooling
CLIMATE TYPE	N	N	N
ELECTRICITY PROTECTION GRADE	I	I	I
NOMINAL VOLTAGE/ FREQUENCY	110-115V/60HZ (USA) 220-240V/50HZ (AU)	110-115V/60HZ (USA) 220-240V/50HZ (AU)	110-115V/60HZ (USA) 220-240V/50HZ (AU)
RATED CURRENT	1.1 A	1.1 A	0.9 A
RATED POWER(W)	80W	80W	72W
REFRIGERANT	R600a	R600a	R600a
AMBIENT TEMPERATURE	32 - 100 °F (0 -38°C)	32 - 100 °F (0 -38°C)	32 - 100 °F (0 -38°C)
TEMPERATURE RANGE	39-64 °F (4 -18°C)	39-64 °F (4 -18°C)	39-64 °F (4 -18°C)
NET WEIGHT	286.60 lbs (130 KGS)	198.41 lbs (90 KGS)	112.43 lbs (51 KGS)
GROSS WEIGHT (INC. PALLET)	310 lbs (141 KGS)	239 lbs (108 KGS)	159 lbs (72 KGS)
DIMENSION	23.54"W x 26.97"D x 71.69"H (598W x 685D x 1821H mm) Included stand height 0.98" (25mm)	23.54"W x 26.97"D x 55.43"H (598W x 685D x 1408H mm) Included stand height 0.98" (25mm)	23.42"W x 23.62"D x 33.86"H; (595W x 600D x 860H mm) Included stand height 0.79" (20mm)

PART IX WARRANTY INFORMATION

Please speak to your retailer before calling us if you did not purchase your refrigerator directly from KingsBottle.

WHO IS COVERED: This warranty is extended only to the original end-user purchaser or the person receiving the product as a gift, and shall not be extended to any other person or transferee.

LIMITED WARRANTY – If your refrigerator is not operating properly, KingsBottle reserves the right to repair or replace the refrigerator. KingsBottle may request the consumer to contact a local refrigeration company to service the refrigerator. All cost for labor and materials is covered for 2-year from the date of receipt. If KingsBottle deems the unit not repairable, KingsBottle will use the value of your original order toward a replacement (Any replacement unit will follow the warranty terms of the initial purchase). For customer service, please e-mail us via service@kingsbottle.com.

THE LIMITED WARRANTY DOES NOT COVER: Damage due to such things as an accident, misuse, abuse, mishandling, neglect, unauthorized repair or any other cause beyond the control of the seller whether similar or dissimilar to the foregoing. Purchaser understands and acknowledges that the goods sold here are WINE & BEVERAGE COOLERS, which house beer and other wines. Purchaser assumes all the risk of using these units, including the risk of spoilage, humidity variations, temperature variations, leaks, fires, water damage, mold, mildew, dryness and similar perils that may occur.

SPECIAL NOTE: Warranty is only honored for the unit which is used in the countries where the unit was initially purchased. And, if your product was purchased at any 3rd party retailer and not directly from KingsBottle, we do not offer an extended warranty policy. You **MUST** contact the retailer of purchase directly. In the event your retailer does not offer an extended warranty plan, we recommend you contact a third party warranty provider. However, regardless of point of purchase, all KingsBottle coolers are backed by a TWO YEAR manufacturer's warranty from date of sale.

COMPRESSOR WINE REFRIGERATORS