

TWH-N | HYDRAULIC TORQUE WRENCHES - LOW PROFILE HEXAGON



Torque capacities up to 48181 Nm

Torque accuracy of +/- 3%

Working pressure 700 bar

- ▶ Lightweight, high grade aluminium body (excluding TWH430N)
- ▶ Output torque capacities from 2625 to 48181 Nm (1906 to 34985 lbf.ft)
- ▶ Low profile design for direct in-line reaction
- ▶ Narrow cassette head design makes it ideal for limited access applications
- ▶ Ratchet head can be easily changed by simply withdrawing/inserting a single pin
- ▶ Imperial ratchet heads available with across flat (AF sizes) sizes from 1 1/16" to 6 7/8" (page 89)
- ▶ Metric ratchet heads available with across flat (AF sizes) sizes from 24 to 175 mm (page 90)
- ▶ Fitted with 360° uni-swivel with quick release couplings for easy positioning of hydraulic hoses

TWH27N, TWH54N, TWH120N, TWH210N
(aluminium body)

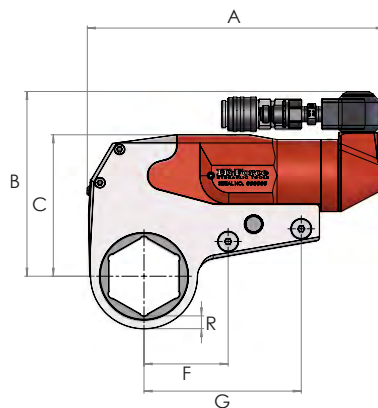

All models



TWH430N (steel body)

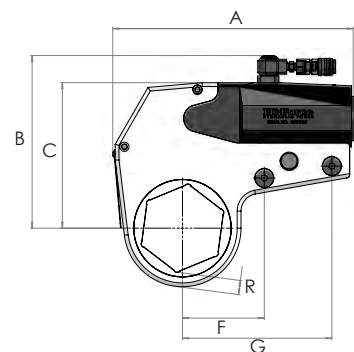

Note: Drawing shows drive cylinder, including ratchet head as detailed on pages 89 and 90.

Drive cylinder and ratchet head are separate items and must be ordered separately.

Model number	Torque capacity		Hexagon AF Size				Weight (kg)	Dimensions (mm)								
	Nm at 700 bar	lbf.ft at 10,000 psi	Metric min	Metric max	Imperial min	Imperial max		A	B	C	D	E	F	G	R (min)	R (max)
TWH27N	2625	1906	24	46	1 1/16"	1 13/16"	1.4	193	125	97	32	51	54	109	9.5	12.2
	3068	2228	50	60	2"	2 3/8"	1.4	193	136	108	32	51	54	109	10.1	10.5
TWH54N	5372	3901	36	65	1 7/16"	2 1/8"	2.3	250	158	125	41	64	73	137	10.7	13.8
	6037	4384	70	80	2 3/4"	3 1/8"	2.3	250	169	136	41	64	73	137	11.7	14.6
TWH120N	11737	8522	50	80	2 3/16"	3 1/8"	3.8	310	189	157	52	78	92	172	14.7	15.2
	14349	10419	85	100	3 1/2"	3 7/8"	3.8	310	214	182	52	78	92	172	15.9	18.7
TWH210N	21216	15405	70	100	2 3/4"	3 7/8"	6.4	378	223	191	64	97	114	213	18.1	18.6
	23124	16791	105	115	4 1/4"	4 5/8"	6.4	378	236	204	64	97	114	213	18.3	20.7
TWH430N	43792	31798	80	115	3 1/8"	4 5/8"	16.1	405	291	242	83	93	146	267	25.6	31.3
	48181	34985	130	175	5"	6 7/8"	16.1	425	309	260	83	93	146	267	24.8	27.3

Note: Above selection table is for drive unit only. Ratchet head(s) to be ordered separately see pages 89 and 90. Weight as stated is drive cylinder only, exact radius size (R) varies according to ratchet AF size selected.