

HSS | SINGLE ACTING MULTI-PURPOSE CYLINDERS



- ▶ Single acting, spring assisted return
- ▶ Nitrocarburised piston rod for corrosion resistance
- ▶ Low friction bearing surfaces
- ▶ Anti-extrusion seals for improved performance at high pressures
- ▶ Collar threads withstand full load
- ▶ Grooved saddles fitted as standard on all models
- ▶ Optional piston rod saddles listed on pages 24 and 25
- ▶ Customised and special design cylinders are available on request

Capacities from 4.5 to 109 tonnes

Stroke lengths from 25 to 457 mm

Working pressure 700 bar

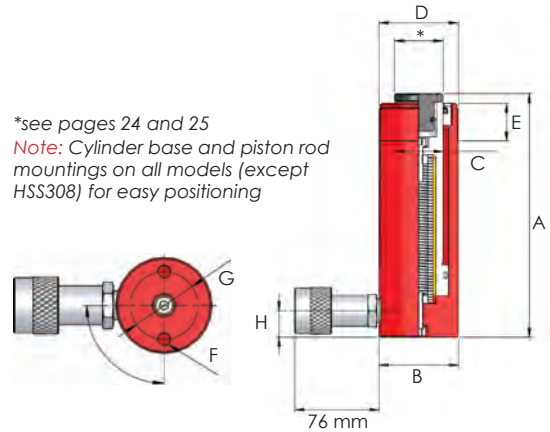

Model number	Capacity (tonnes)	Stroke (mm)	Oil capacity (cm ³)	Cylinder eff. area (cm ²)	Weight (kg)	Dimensions (mm) (unless otherwise stated)							
						A	B	C	D	E	F	G	H
HSS51	4.5	25	16	6.4	1.0	107	38	24	1 1/2"-16 UN	28	M6	25	19
HSS52	4.5	50	32	6.4	1.2	132	38	24	1 1/2"-16 UN	28	M6	25	19
HSS53	4.5	75	48	6.4	1.4	157	38	24	1 1/2"-16 UN	28	M6	25	19
HSS54	4.5	100	64	6.4	1.5	182	38	24	1 1/2"-16 UN	28	M6	25	19
HSS55	4.5	125	80	6.4	1.8	207	38	24	1 1/2"-16 UN	28	M6	25	19
HSS57	4.5	176	113	6.4	2.0	258	38	24	1 1/2"-16 UN	28	M6	25	19
HSS59	4.5	227	146	6.4	2.4	308	38	24	1 1/2"-16 UN	28	M6	25	19
HSS101	10	25	36	14.4	1.8	100	57	35	2 1/4"-14 UN	27	M8	40	19
HSS102	10	56	81	14.4	2.4	131	57	35	2 1/4"-14 UN	27	M8	40	19
HSS104	10	100	144	14.4	3.0	175	57	35	2 1/4"-14 UN	27	M8	40	19
HSS106	10	150	217	14.4	4.2	225	57	35	2 1/4"-14 UN	27	M8	40	19
HSS108	10	206	297	14.4	5.0	281	57	35	2 1/4"-14 UN	27	M8	40	19
HSS1010	10	250	361	14.4	5.4	325	57	35	2 1/4"-14 UN	27	M8	40	19
HSS1012	10	305	440	14.4	6.2	379	57	35	2 1/4"-14 UN	27	M8	40	19
HSS152	14.5	50	101	20.3	3.4	154	70	41	2 3/4"-16 UN	39	M10	48	19
HSS154	14.5	100	203	20.3	5.0	204	70	41	2 3/4"-16 UN	39	M10	48	19
HSS156	14.5	150	304	20.3	6.6	254	70	41	2 3/4"-16 UN	39	M10	48	19
HSS1510	14.5	250	507	20.3	8.8	354	70	41	2 3/4"-16 UN	39	M10	48	19
HSS252	25	51	178	34.9	6.5	174	86	54	3 5/8"-12 UN	49	M12	60	25
HSS254	25	102	356	34.9	8.0	225	86	54	3 5/8"-12 UN	49	M12	60	25
HSS256	25	150	524	34.9	9.6	273	86	54	3 5/8"-12 UN	49	M12	60	25
HSS258	25	203	709	34.9	11.2	324	86	54	3 5/8"-12 UN	49	M12	60	25
HSS2510	25	250	874	34.9	12.6	374	86	54	3 5/8"-12 UN	49	M12	60	25
HSS2514	25	356	1242	34.9	16.8	480	86	54	3 5/8"-12 UN	49	M12	60	25
HSS2518	25	457	1597	34.9	21.4	611	86	54	3 5/8"-12 UN	49	M12	60	25
HSS308	29	205	860	41.9	18.6	374	102	57	3 5/8"-12 UN	50	-	-	50
HSS502	50	51	364	71.3	13.0	150	127	79	5"-12 UN	55	M12	85	20
HSS504	50	102	728	71.3	16.8	201	127	79	5"-12 UN	55	M12	85	20
HSS506	50	152	1084	71.3	20.0	251	127	79	5"-12 UN	55	M12	85	20
HSS508	50	203	1448	71.3	23.2	302	127	79	5"-12 UN	55	M12	85	20
HSS5013	50	330	2354	71.3	33.6	429	127	79	5"-12 UN	55	M12	85	20
HSS756	73	152	1561	102.7	31.0	272	146	95	5 3/4"-12 UN	45	M12	115	32
HSS1004	109	102	1565	153.4	41.6	223	185	114	6 7/8"-12 UN	50	M12	146	32
HSS1006	109	153	2347	153.4	49.8	274	185	114	6 7/8"-12 UN	50	M12	146	32
HSS10010	109	254	3896	153.4	65.5	375	185	114	6 7/8"-12 UN	50	M12	146	32

Note: If specifying this cylinder for use with the SLF and SLV synchronous lifting systems and associated mounting kit, please consider the increase in dimension A (closed height), see pages 44 and 48.