



MULTI SPLIT SYSTEM OUTDOOR UNITS

SERVICE MANUAL

Multi zone

Two, Three, Four and Five Zones

DC INVERTER MULTI ZONE OUTDOOR UNITS

Revision A: ODMI-E-1610-PDB56/2017



Model Numbers:

YN020GMFI22M2D	Dual (2 Zones)
YN030GMFI22M3D	Triple (3 Zones)
YN040GMFI22M4D	Quad (4 Zones)
YN050GMFI22M5D	Quint (5 Zones)

Table of Contents

1. Indoor Unit Combination Table
2. Suggested Indoor Unit Model Numbers
3. Dimension Of Outdoor Unit
4. Refrigerant Cycle Diagram
5. Installation Details
6. Electronic Function
7. Wiring Diagrams
8. Trouble Shooting
9. Disassembly Instructions (Coming Soon)



WARNING

- Installation MUST conform with local building codes or, in the absence of local codes, with the National Electrical Code NFPA70/ANSI C1-1993 or current edition and Canadian Electrical Code Part1 CSA C.22.1.
- The information contained in the manual is intended for use by a qualified service technician familiar with safety procedures and equipped with the proper tools and test instruments
- Installation or repairs made by unqualified persons can result in hazards to you and others as well as irreversible equipment damage.
- Failure to carefully read and follow all instructions in this manual can result in equipment malfunction, property damage, personal injury and/or death.



CONTENTS

1. Indoor Unit Combination.....	3
2. Dimension Of Outdoor Unit.....	4
3. Refrigerant Cycle Diagram.....	5
4. Installation Details.....	7
5.1 Wrench torque sheet for installation.....	7
5.2 Connecting the cables.....	7
5.3 Pipe length and the elevation.....	7
5.4 Installation for the first time.....	8
5.5 Adding the refrigerant after running the system for many years.....	12
5.6 Procedure when servicing the indoor unit refrigeration circuit.....	14
5.7 Evacuation after servicing the outdoor unit refrigeration circuit.....	14
6. Electronic Function.....	15
6.1 Abbreviation.....	15
6.2 Electric control working environment.....	15
6.3 Main Protection.....	15
6.4 Control and Functions.....	17
7. Wiring Diagrams.....	20
8. Troubleshooting.....	24
8.1 Safety.....	24
8.2 Indoor Unit Error Display.....	25
8.3 Outdoor Unit Display.....	30
8.4 Diagnosis and Solution.....	33
8.5 Trouble Criterion Of Main Parts.....	74
9. Disassembly Instructions.....	99

1. Indoor Unit Combination

Multi DC Outdoor Unit	Min~Max (Nominal) Capacity	Suggested Combination	Limit
TWO Zone	12,000~24,000 (18,000) BTU/h	12	None
		9+9	
		9+12	
		12+12	

Multi DC Outdoor Unit	Min~Max (Nominal) Capacity	Suggested Combination	Limit
THREE Zone	18,000~36,000 (27,000) BTU/h	Suggested Combination	Maximum 1 piece DUCTED or FLEXMOUNT Indoor unit
		9+9	
		9+12	
		9+18	
		12+12	
		12+18	
		18+18	
		9+9+9	
		9+9+12	
		9+9+18	
		9+12+12	
		9+12+18	
		12+12+12	

Multi DC Outdoor Unit	Min~Max (Nominal) Capacity	Suggested Combination	Limit
FOUR Zone	24,000~48,000 (36,000) BTU/h	9+18	None
		12+12	
		12+18	
		18+18	
		9+9+9	
		9+9+12	
		9+9+18	
		9+12+12	
		9+12+18	
		9+18+18	
		12+12+12	
		12+12+18	
		12+18+18	
		9+9+9+9	
		9+9+9+12	
		9+9+9+18	
		9+9+12+12	
		9+9+12+18	
9+12+12+12			
12+12+12+12			

Multi DC Outdoor Unit	Min~Max (Nominal) Capacity	Suggested Combination	Limit
FIVE Zone	36,000~64,000 (48,000) BTU/h	18+18	None
		18+24	
		24+24	
		9+9+18	
		9+9+24	
		9+12+12	
		9+12+18	
		9+12+24	
		9+18+18	
		9+18+24	
		9+24+24	
		12+12+12	
		12+12+18	
		12+12+24	
		12+18+18	
		12+18+24	
		12+24+24	
		18+18+18	
		18+18+24	
		9+9+9+9	
		9+9+9+12	
		9+9+9+18	
		9+9+9+24	
		9+9+12+12	
		9+9+12+18	
		9+9+12+24	
		9+9+18+18	
		9+9+18+24	
		9+12+12+12	
		9+12+12+18	
		9+12+12+24	
		9+12+18+18	
9+9+9+9+9			
9+9+9+9+12			
9+9+9+9+18			
9+9+9+9+24			
9+9+9+12+12			
9+9+9+12+18			
9+9+9+18+18			
9+9+12+12+12			
9+9+12+12+18			
9+12+12+12+12			
9+12+12+12+18			
12+12+12+12+12			

2. Dimension of the Outdoor Units

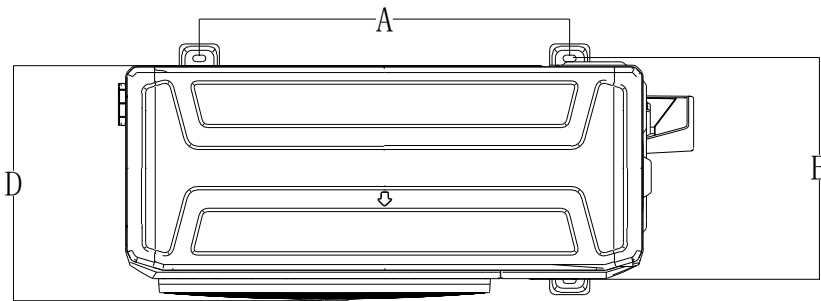
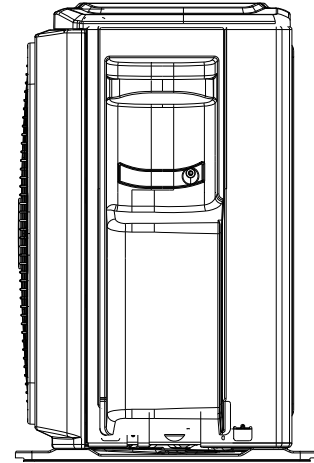
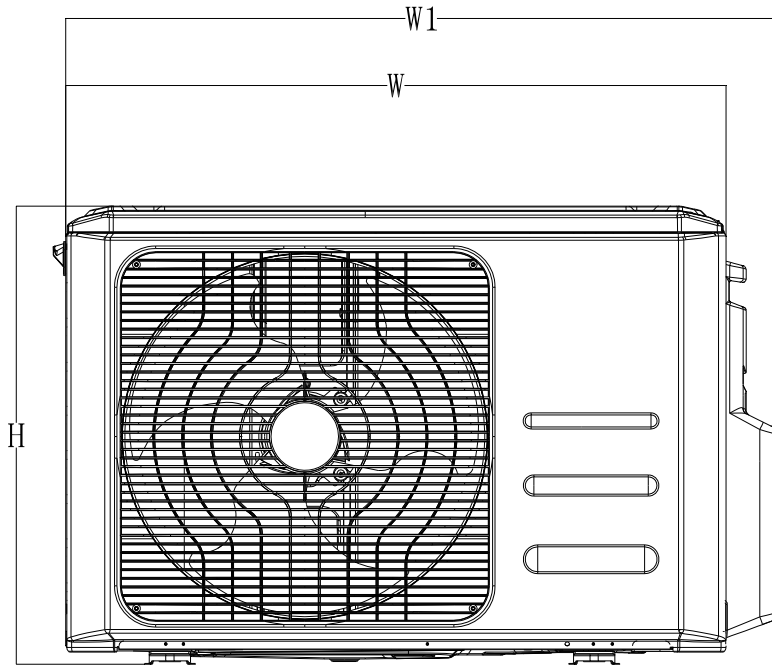

Model	Unit:	W	D	H	W1	A	B
YN020GMFI22M2D	mm	845	363	702	923	540	350
	inch	33.3	14.3	27.6	36.0	21.3	13.8
YN030GMFI22M3D	mm	946	410	810	1034	673	403
	inch	37.2	16.5	31.9	40.6	26.5	15.9
YN040GMFI22M4D	mm	946	410	810	1034	673	403
	inch	37.2	16.5	31.9	40.6	26.5	15.9
YN050GMFI22M5D	mm	952	415	1333	1045	634	404
	inch	37.5	16.3	52.5	41.1	25.0	15.9

Note: 5 circuit model will have 2 fans.

3. Refrigerant Cycle Diagram

4.1 Refrigeration circuit drawing of inverter DUAL (2 Zone)

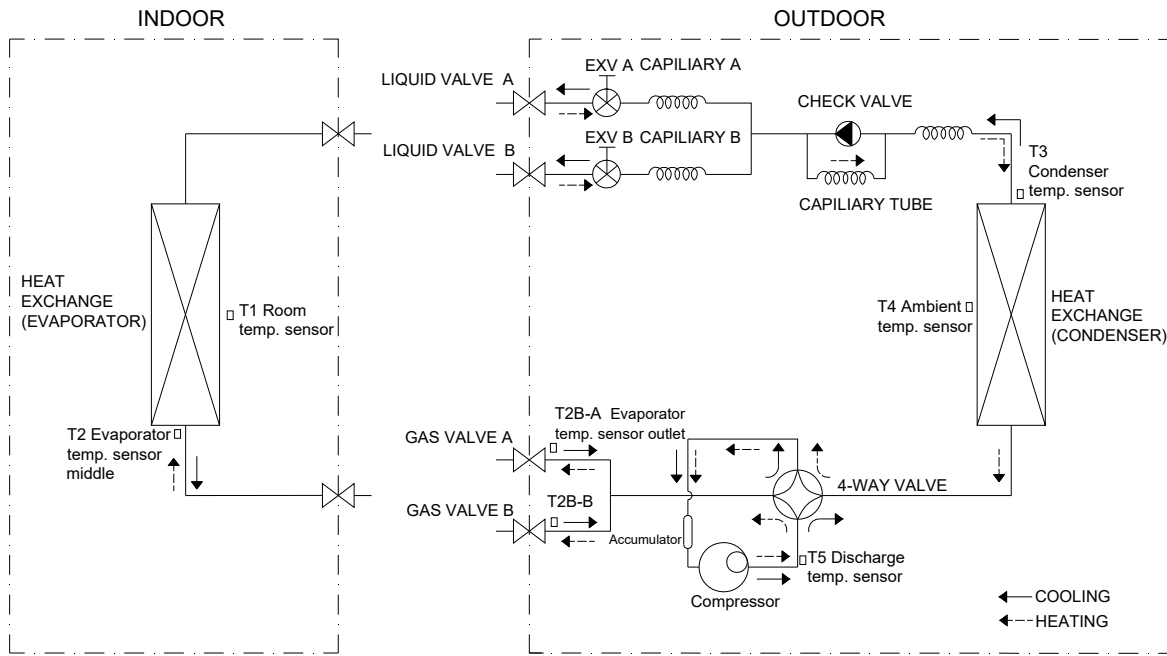

4.2 Refrigeration circuit drawing of inverter TRIPLE (3 Zone)

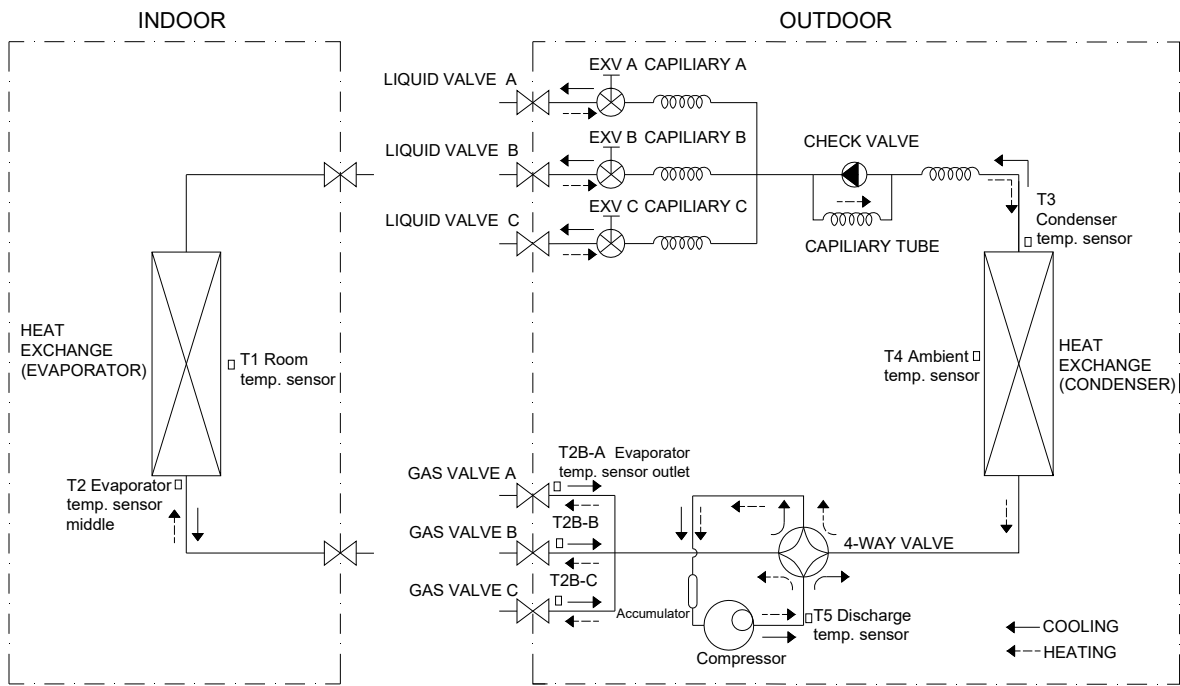

4.3 Refrigeration circuit drawing of inverter Quad (4 Zone)

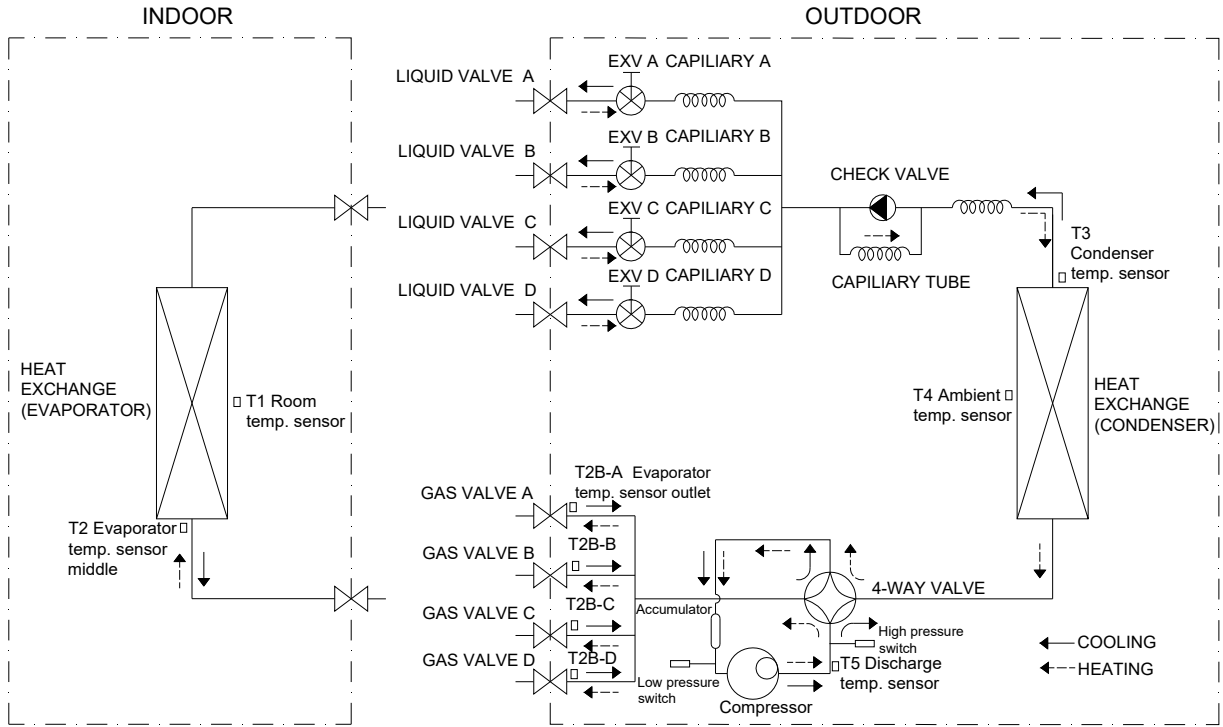

4.4 Refrigeration circuit drawing of inverter Quint (5 Zone)

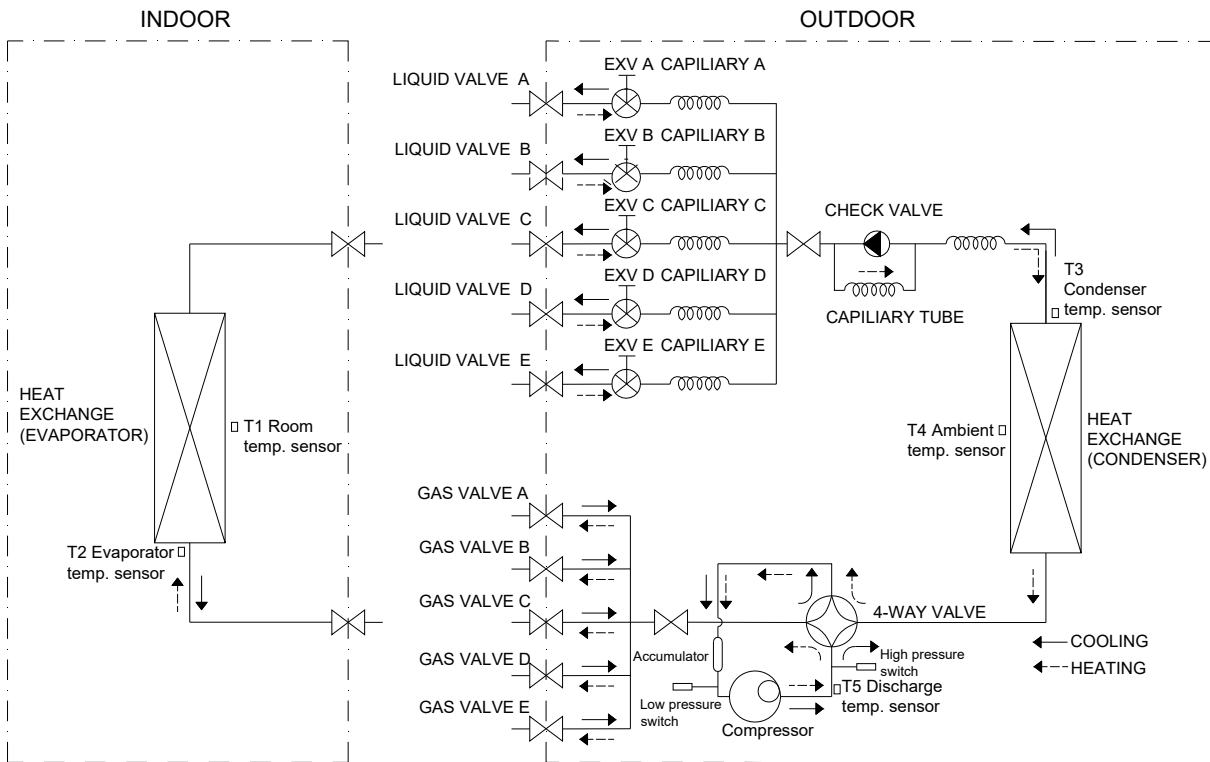

4. Installation Details

5.1 Wrench torque sheet for installation

Outside diameter		Torque	Additional tightening torque
mm	inch	N.cm	N.cm
Φ6.35	1/4	1500 (11 LbF*Ft)	1600 (12 LbF*Ft)
Φ9.52	3/8	2500 (18 LbF*Ft)	2600 (19LbF*Ft)
Φ12.7	1/2	3500 (26 LbF*Ft)	3600 (27 LbF*Ft)

5.2 Connecting the cables

The main power input connection wire size should be selected according to the following table.

Unit	AWG
DUAL (2 Zone)	14
TRIPLE (3 Zone)	14
QUAD (4 Zone)	12
QUINT (5 Zone)	10

For the cable set connecting indoor units to the outdoor unit, use 16AWG (for all indoor types).

5.3 Pipe length and the elevation

Maximum piping length and height difference

		2 Zone	3 Zone	4 Zone	5 Zone
Max. length for all rooms (m)		30 (100ft)	45 (150ft)	60 (200ft)	75 (250ft)
Max. length to one Indoor Unit (m)		20 (65ft)	25 (80ft)	30 (100ft)	30 (100ft)
Max. height difference between Indoor / Outdoor (m)	ODU higher than IDU	10 (33ft)	10 (33ft)	10 (33ft)	10 (33ft)
	ODU lower than IDU	15 (50ft)	15 (50ft)	15 (50ft)	15 (50ft)
Max. height difference between Indoor Units (m)		10 (33ft)	10 (33ft)	10 (33ft)	10 (33ft)

Additional refrigerant charge

		2 Zone	3 Zone	4 Zone	5 Zone
Pre-charged up to max total pipe length m (ft)		15 (50 ft)	22.5 (75 ft)	30 (100 ft)	37.5 (125 ft)
Additional refrigerant charge needed beyond total max length	g	15 g per excess meter beyond total 15 meters	15 g per excess meter beyond total 23 meters	15 g per additional feet beyond total 30 feet	15 g per additional feet beyond total 38 feet
	oz	0.16 oz per excess foot beyond total 50 feet	0.16 oz per excess foot beyond total 75 feet	0.16 oz per excess foot beyond total 100 feet	0.16 oz per excess foot beyond total 125 feet

Caution:

- Refrigerant pipe diameters change according to indoor unit model to be connected. When extending the pipes, refer to the tables below.
- When refrigerant pipe diameter is different from that of the outdoor unit connectors, additional adapter(s) would be required and will be factory supplied with your unit.

Indoor unit		Extension pipe diameter (mm/inch)	
Model	Pipe diameter (mm/inch)		
9K	Liquid 6.35 (1/4)	Liquid	6.35 (1/4)
	Gas 9.52 (3/8)	Gas	9.52 (3/8)
12K 18K	Liquid 6.35 (1/4)	Liquid	6.35 (1/4)
	Gas 12.7 (1/2)	Gas	12.7 (1/2)
24K	Liquid 9.52 (3/8)	Liquid	9.52 (3/8)
	Gas 15.9 (5/8)	Gas	15.9 (5/8)
Outdoor unit union diameter (mm/inch)			
Dual (2 Zone)		Liquid	6.35 (1/4) *2
		Gas	9.52 (3/8) *2
Triple (3 Zone)		Liquid	6.35 (1/4) *3
		Gas	9.52 (3/8) *3
Quad (4 Zone)		Liquid	6.35 (1/4) *4
		Gas	9.52 (3/8) *3
			12.7 (1/2) *1
Quint (5 Zone)		Liquid	6.35 (1/4) *5
		Gas	9.52 (3/8) *3
			12.7 (1/2) *2

5.4 Installation for the first time:

Air and moisture in the refrigerant system will result in significant problems with your system:

- Pressure in the system rises.
- Operating current rises.
- Cooling or heating efficiency drops.
- Moisture in the refrigerant circuit may freeze and block flow through the expansion devices.
- Water when mixed with the refrigerant and oil will create acid that will damage the motor windings and components of the compressor.

PROCEDURE FOR DUAL (2) ZONE OUTDOOR UNITS ARE DIFFERENT FROM OTHERS.

5.4.1. FOR DUAL (2 ZONE SYSTEMS):

Indoor units and the pipes between indoor and outdoor units must be evacuated and leak tested to remove trapped air and moisture from the system. ONE CIRCUIT AT A TIME. This procedure should start after all electrical connections are finalized and the system receives proper power for immediate test running, to be performed one circuit at a time.

Evacuation using a vacuum pump:

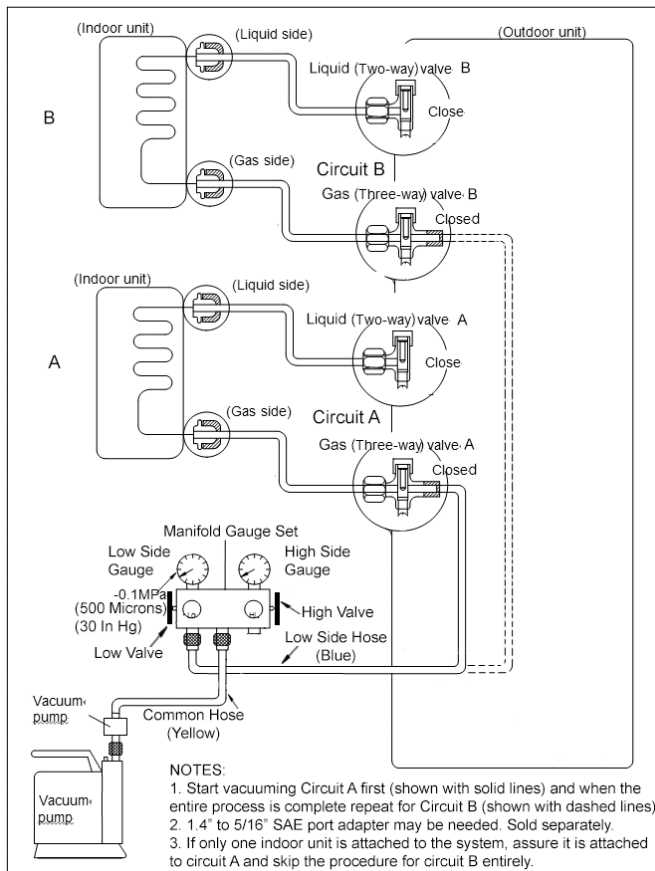

1. Completely tighten ALL brass flare nuts, which connect the ends of copper refrigerant lines to the attached indoor units and the circuit service valves on the outdoor unit, using proper torque.

2. Assure that both the 2-way (Liquid) and 3-way (Gas) valves for each circuit at the outdoor unit STAY CLOSED as they arrived originally.
3. Connect the low pressure hose on your gauge manifold (usually blue) to the 3-way (Gas) valve's service port, belonging to circuit A. Note: If there is only one indoor unit it should be connected to circuit A as the primary.
4. If the manifold gauge set's hoses have 1/4" SAE connections, a 1/4" to 5/16" SAE port adapter will be needed. (Sold separately).
5. Connect the center hose of the gauge manifold (usually yellow) to the vacuum pump.
6. Fully open the Low side valve on the low pressure side of your gauge manifold. Assure that the High side valve on the high pressure side of your gauge manifold stays closed.
7. Start the vacuum pump and operate according to pump manufacturer's specifications. If your vacuum pump has a valve, open it as well.
8. Perform vacuuming / evacuation for a minimum period of 30 minutes and check that the low pressure gauge indicates a vacuum of 30 in/hg (500 microns). (A more sensitive vacuum gauge should be used if available).
9. If the proper vacuum cannot be achieved within 30 minutes, the vacuum pump should be kept running for an additional 15 minutes. If after the additional 15 minutes of operation, the vacuum still cannot be achieved, there could be a leak at one or more of the flare pipe connections at either end of a refrigerant pipes. Leak must be located and the leaking nut must be tightened properly before re-vacuuming the circuit.
10. If the vacuum is achieved, close the low side valve at the low pressure side on your gauge manifold first and shut the vacuum pump off. Leave the gauge manifold set and the hoses connected and recheck the vacuum reading 15 minutes later to assure there is no vacuum loss. (Very small increase in vacuum level is normal).
11. Circuit A is now dry and free of contaminants. Do not remove the hose of your gauge manifold set from the service port.
12. Remove the 2-way (Liquid) Valve's brass dust cap of circuit A. Insert proper size Allen wrench into the valve core and turn it counter clockwise for 1 turn for, wait for 3 seconds and quickly close the valve by turning it in reverse direction. Check your low pressure gauge on the manifold to assure it now indicates positive pressure of approximately 80 to 120 PSI in your lines.
13. Apply soap-water mixture on both the indoor unit connections and the outdoor unit connections for circuit A with a soft brush to check for leakage at the connecting points of the piping. If you notice air bubbles, the specific connector has leakage and must be tightened to stop the leakage.

(An electronic leak detector will be more efficient to use for this if available).

14. Re-insert proper size Allen wrench into the valve core of the Liquid Valve (2 way) valve for circuit A and turn it counter clockwise until it is fully back seated. Do not force it, once it stops turning. Repeat the leak checking procedure entirely at all connections of circuit A. If you find a new leak, close the 2-way (Liquid) valve you just opened first and tighten the flare nut at the leaking connection until the leak is sealed. Reopen the 2-way (Liquid) valve and check again.
15. Remove the 3-way (Gas) Valve's dust cap for circuit A. Insert proper size Allen wrench into the valve core and turn it counter clockwise until it is fully back seated. Do not force it, once it stops turning.
16. Power up the system, and run the indoor unit for circuit A in COOLING mode to assure that all functions are working.
17. Switch the indoor unit of circuit A to HEAT mode and assure that all functions are working.
18. Set the temperature on remote to HIGHEST setting and while the unit is running in heat mode, check one last time for leaks at all 4 related pipe connections of circuit A. It is easier to catch even smallest leaks in HEAT mode as the pressures are much higher.
19. If you discover a leak that cannot be stopped by tightening the flare nuts at this stage, shut off both 2 way (liquid) and 3 way (Gas) service valves, repair the leak properly and start from the beginning. Please remember you may need to add fresh refrigerant to the system as a significant value may be lost at this stage.
20. **REPEAT THIS ENTIRE PROCEDURE FOR THE CIRCUIT B, if it is being utilized by a second indoor unit.**

5.4.2. FOR THREE, FOUR and FIVE ZONE SYSTEMS):

Indoor units and the pipes between indoor and outdoor units must be evacuated and leak tested to remove trapped air and moisture from the system. This procedure should start after all electrical connections are finalized and the system receives proper power for the test running.

PROCEDURE FOR 2, 4 AND 5 ZONE OUTDOOR UNITS ARE DIFFERENT FROM 2 ZONE MODELS.

For installation convenience, one set of COMMON (or MASTER) Service valves have been adopted into the 3, 4 and 5 zone systems. The common (master) set of service valves control the common refrigerant circuitry behind the standard sets of

circuit service valves, where the indoor units are attached. See the red circles on the picture below.

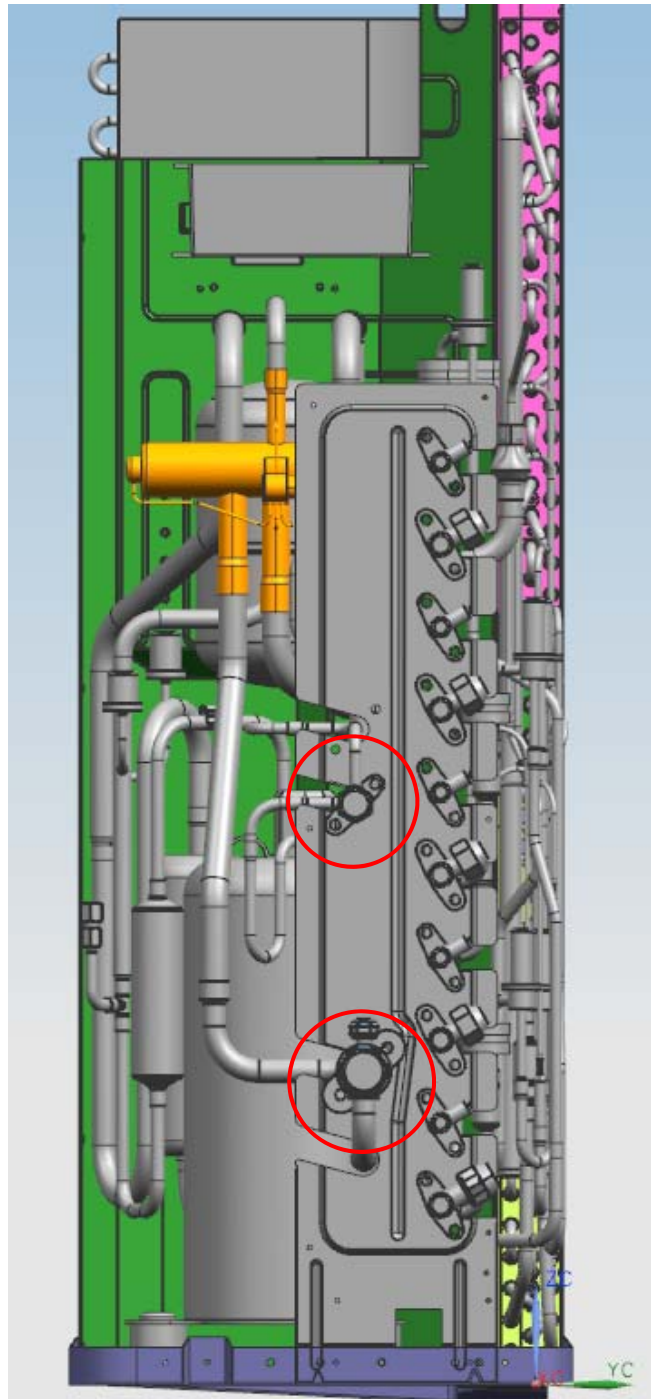

Picture shows the 5 circuit model where the Common (Master) valves are located to the left of the area assigned for the circuit service valves. Layout for the 3 and 4 circuit models are similar but the Common (Master) valves are located at the top of the area assigned for the circuit valves.

Evacuation using a vacuum pump:

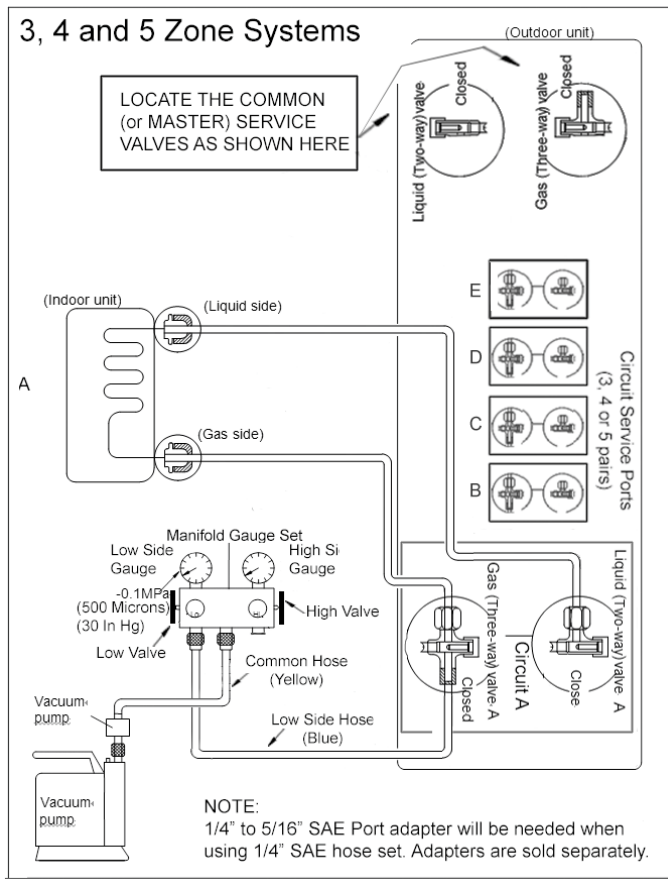

1. Completely tighten ALL brass flare nuts, which connect the ends of copper refrigerant lines to the attached indoor units and the circuit service valves on the outdoor unit using proper torque.
2. Assure that both of the 2-way (Liquid) and 3-way (Gas) valves for Each Circuit at the outdoor unit STAY CLOSED as they arrived.
3. Connect the low pressure hose on your gauge manifold (usually blue) to the 3-way (Gas) valve's service port, belonging to circuit A. Note: First and the largest capacity indoor unit should always be connected to circuit A as primary.
4. If the manifold gauge set's hoses have 1/4" SAE connections, a 1/4" to 5/16" SAE port adapter will be needed. (Sold Separately).
5. Connect the center hose of the gauge manifold (usually yellow) to the vacuum pump.
6. Fully open the Low side valve on the low pressure side of your gauge manifold. Assure that the High side valve on the high pressure side of your gauge manifold stays closed.
7. Start the vacuum pump and operate according to pump manufacturer's specifications. If your vacuum pump has a valve, open it as well.
8. Perform vacuuming / evacuation for a minimum period of 30 minutes and check that the low pressure gauge indicates a vacuum of 30 in/hg (500 microns). (A more sensitive vacuum gauge should be used if available).

9. If the proper vacuum cannot be achieved within 30 minutes, the vacuum pump should be kept running for an additional 15 minutes. If after the additional 15 minutes of operation, the vacuum still cannot be achieved, there could be a leak at one or more of the flare pipe connections at either end of a refrigerant pipes. Leak must be located and the leaking nut must be tightened properly before re-evacuating the circuit.
10. If the vacuum is achieved, close the low side valve at the low pressure side on your gauge manifold first and shut the vacuum pump off. Leave the gauge manifold set and the hoses connected and recheck the vacuum reading 15 minutes later to assure there is no vacuum loss. (Very small increase in vacuum level is normal).
11. Circuit A is now dry and free of contaminants. Do not remove the hose of your gauge manifold set from the service port.
12. Remove the 2-way (Liquid) **Common (Master) Valve's** brass dust cap. Insert proper size Allen wrench into the valve core and turn it until it is back seated. Do not force it once it stops turning.
13. Remove the 3-way (Gas) **Common (Master) Valve's** brass dust cap. Insert proper size Allen wrench into the valve core and turn it until it is back seated. Do not force it once it stops turning.
14. Remove the 2-way (Liquid) Valve's brass dust cap of **circuit A**. Insert proper size Allen wrench into the valve core and turn it counter clockwise for 1 turn for, wait for 3 seconds and quickly close the valve by turning it in reverse direction. Check your low pressure gauge on the manifold to assure it now indicates positive pressure of approximately 80 to 120 PSI in your lines.
15. Apply soap-water mixture on both the indoor unit connections and the outdoor unit connections for circuit A with a soft brush to check for leakage at the connecting points of the piping. If you notice air bubbles, the specific connector has leakage and must be tightened to stop the leakage. (An electronic leak detector will be more efficient to use for this if available).
16. Re-insert proper size Allen wrench into the valve core of the Liquid Valve (2 way) valve for **circuit A** and turn it counter clockwise until it is fully back seated. Do not force it, once it stops turning. Repeat the leak checking procedure entirely at all connections of circuit A. If you find a new leak, close the 2-way (Liquid) valve you just opened first and tighten the flare nut at the leaking connection until the leak is sealed. Reopen the 2-way (Liquid) valve and check again.
17. Remove the 3-way (Gas) Valve's dust cap for **circuit A**. Insert proper size Allen wrench into the valve core and turn it counter clockwise until it is fully back seated. Do not force it, once it stops turning.

18. Power up the system, and run the indoor unit for circuit A in COOLING mode to assure that all functions are working.
19. Switch the indoor unit of circuit A to HEAT mode and assure that all functions are working.
20. Set the temperature on remote to HIGHEST setting and while the unit is running in heat mode, check one last time for leaks at all 4 related pipe connections of circuit A. It is easier to catch even smallest leaks in HEAT mode as the pressures are much higher.
21. If you discover a leak that cannot be stopped by tightening the flare nuts at this stage, shut off both 2 way (liquid) and 3 way (Gas) service valves, repair the leak properly and start from the beginning. Please remember you may need to add fresh refrigerant to the system as a significant value may be lost at this stage.
22. **REPEAT THIS ENTIRE PROCEDURE FOR THE REMAINING CIRCUITS, B, C, D, E. Skip if a circuit is not being utilized by an indoor unit. In case an indoor unit is added in the future, the same procedure should be followed for that added circuit entirely.**

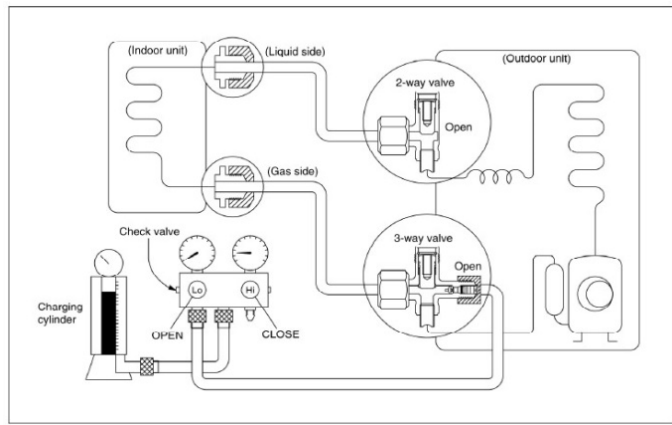

2. For 3, 4 and 5 zone systems, connect the low pressure hose from the gauge manifold set (this is usually the blue hose on most sets) to the 3-way (Gas) service valve of the Common (master) circuit. See below drawing

5.4.3. Adding refrigerant if the pipe length exceeds standard factory pre-charge amount:

Your system is pre-charged with sufficient refrigerant to work properly, according to an average length of 7.5 meter (25 feet) piping for each of the available circuits (example a 4 zone system can have total piping length for all zones added together of 30 meters (100 feet) max. If your total piping length exceeds this limit, additional refrigerant must be added to the system to compensate for the difference.

Procedure:

PROCEDURE FOR 2, 4 AND 5 ZONE OUTDOOR UNITS ARE DIFFERENT FROM 2 ZONE MODELS. See Specific instructions below for each type as it applies to your specific model.

1. For Dual (2 Zone) systems, connect the low pressure hose on your gauge manifold (usually blue) to the 3-way (Gas) valve's service port of one of the occupied circuits (Circuit A preferred). See below drawing.

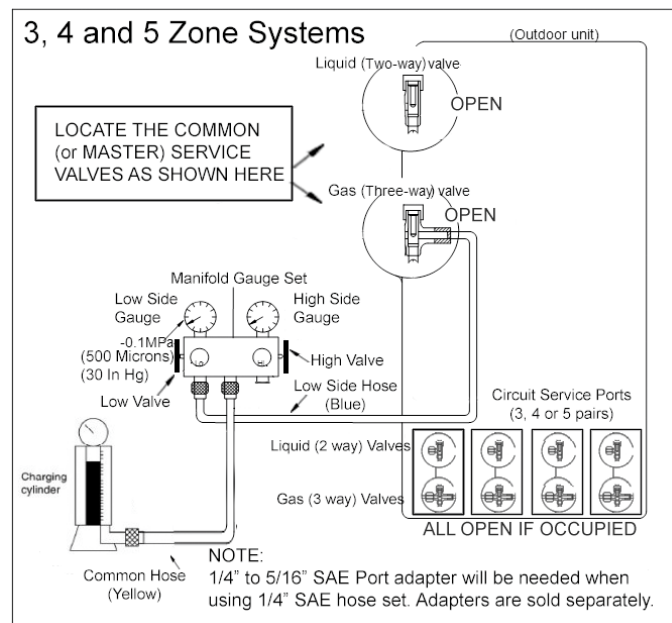

3. Connect the center hose of the gauge manifold (usually yellow) to the refrigerant container (this is usually the yellow hose on most sets). Refrigerant 410A can only be charged in Liquid form while the container must be inverted (upside down). Note that all 2-way (Liquid) and 3-way (Gas) valves for all "occupied" circuits where an indoor unit is attached must be in the open position. Additionally, for 3, 4 and 5 circuit models, the common (master) 2-way (Liquid) and 3-way (Gas) valves must also be in open position.
4. The air trapped in the gauge manifold and the hoses must be purged out. Use the pressure from the system to purge the low side hose, by briefly loosening its connection at the gauge manifold for a second. Next, open the valve of the refrigerant container to pressurize the center hose and loosen the connector of the center hose at the gauge manifold for a second and purge that line.
5. Determine the volume of the additional refrigerant added into the system for the additional piping.

6. Set the refrigerant container on an electronic charging scale and record the weight (or zero-out the scale depending on the scale used).
7. Start all indoor units attached to the system in cooling mode and lower the set points on each of their controllers to the minimum setting so the system will not shut off during the procedure.
8. Refrigerant can now be added to the system, open the low side valve at the low pressure side of the gauge manifold set to start charging the unit with liquid refrigerant. Please remember to nurse the refrigerant in slowly by controlling the low side valve at the Low pressure side of your gauge manifold (open for 3 seconds and close for 10 seconds for the system to digest each load). Keep track of the refrigerant being added into the system (do not overcharge the system).
9. Once the correct charge has been added to the system, close the low side valve at the low pressure side of the gauge manifold set and check the operating pressure. Keep running the system continuously for 20 minutes and record the pressure reading along with the indoor and outdoor temperature readings for future reference. The system is now charged and can be shut off.
10. Close the valve on the refrigerant container and disconnect the hose from the manifold set, also disconnect the hose from the 3-way (Gas) valve where it is attached to the unit and replace and torque all brass dust caps.

Be sure to use a torque wrench to tighten the service port caps to a torque 18N·m (13.27 ft·lbs).

Always leak check all service ports after servicing the refrigerant system.

5.5 Adding or replacing the refrigerant after a refrigerant loss is discovered:

Please note: R410a is a blended and isotropic refrigerant. If refrigerant is lost from your system in significant amounts (exceeding 15% of the total volume), the remaining refrigerant may no longer contain the proper original ratio of the blend. Therefore system must be entirely evacuated and recharged with fresh refrigerant. If the system is determined to have lost only a small amount of refrigerant, it can be topped off using the same procedure as covered above in paragraph 5.4.3, until proper operating pressures and performance are obtained. Prior to recharging refrigerant after a leak is discovered, the leak itself must be located and repaired to avoid the repeated refrigerant losses. A well-sealed system will never need refrigerant to be recharged as it stays as a sealed-closed system entirely. Below procedure explains complete evacuation and fresh refrigerant recharge procedure.

Procedure

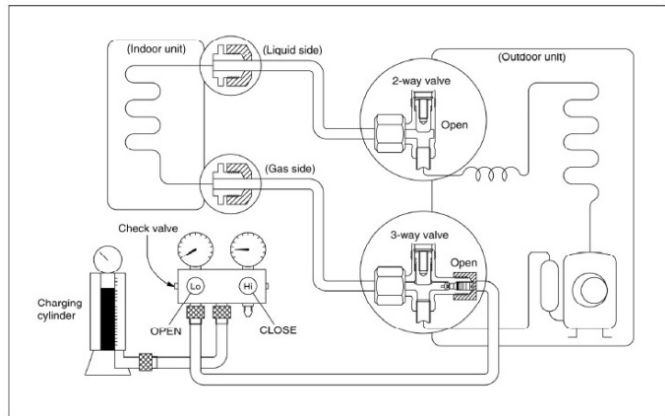

1. Keep all attached indoor units connected and assure that all of the brass flare nuts at all pipe connections both at the indoor and outdoor unit connectors are tight and leak free.
2. Assure ALL of the 2-way (Liquid) and 3-way (Gas) service valves of the utilized circuits (where an indoor unit is attached) are fully open.
3. For 3, 4 and 5 zone systems, also assure that both of the Common (Master) 2-way (Liquid) and 3-way (Gas) service valves are fully open.
4. Assure that the 2-way (Liquid) and 3-way (Gas) service valves of any unused circuit are fully closed.
5. Next step is different for 2 zone and 3/4/5 zone systems. See 5a. and 5b. accordingly:
 - a. If servicing a Two Zone (dual split) system, connect the low pressure hose on your gauge manifold (usually blue) to the 3 way (Gas) valve's service port, belonging to circuit A. Additionally connect the high pressure hose on your gauge manifold (usually red) to the 3 way (Gas) valve's service port, belonging to circuit B. (*Ignore this if there is only one indoor unit attached to the system. Single indoor units should always be attached to circuit A.*) Fully open both the Low side valve on the low pressure side and the High side valve on the high pressure side of your gauge manifold. (Keep the High side valve at the High pressure side of the gauge manifold closed if there is only a single indoor unit attached to the system) *If the manifold gauge set's hoses have 1/4" SAE connections, two 1/4" to 5/16" SAE port adapters will be needed, one for each circuit. See below drawing.*

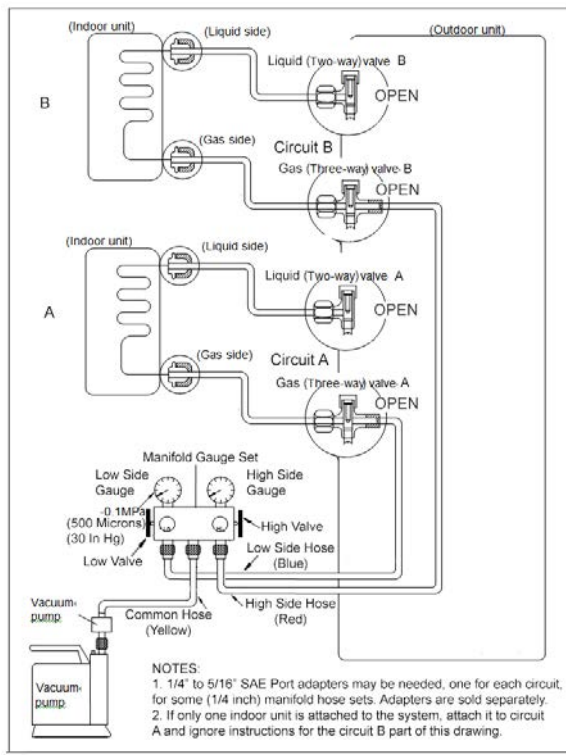

- b. If servicing a 3, 4 or 5 zone system, connect only the low pressure hose on your gauge manifold (usually blue) to the 3 way (Gas) valve's service port, belonging to the COMMON or the MASTER Circuit. Fully open the Low side valve on the low pressure side of your gauge manifold only. See below drawing.

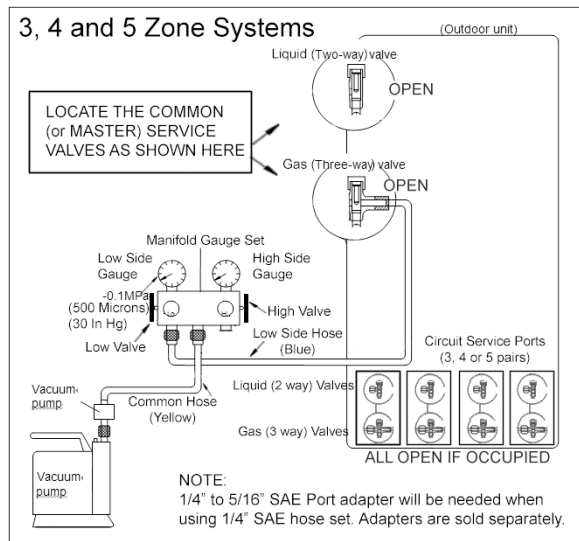

6. Connect the center hose of the gauge manifold (usually yellow) to the vacuum pump.
7. Start the vacuum pump and operate according to pump manufacturer's specifications.
8. Perform vacuuming/evacuation for a minimum total period of 30 minutes for each attached circuit added together (example 90 minutes for a system with 3 indoor units) and check that the low pressure gauge indicates a vacuum of 30 in/hg (500 microns). (A more sensitive vacuum gauge should be used if available).

9. If the proper vacuum cannot be achieved within this time frame, the vacuum pump should be kept running for an additional 1 hour. If after the additional 1 hour of operation the vacuum still cannot be achieved, there could be a leak at one or more of the flare pipe connections at either end of a refrigerant pipe. Leak must be located and the nut must be tightened properly.
10. If the vacuum is achieved, close the valve(s) on your gauge manifold set first and shut the vacuum pump off. Leave the gauge manifold and the hose connected and recheck the vacuum reading 30 minutes later to assure there is no vacuum loss. (Small insignificant increase in the vacuum level is normal).
11. ALL occupied circuits as well as the outdoor unit are now dry and free of contaminants. Do not remove the hose of your gauge manifold set from the service port(s).
12. Connect the middle hose from the manifold set to the refrigerant container (this is the yellow line on most sets). With refrigerant 410A the container must be inverted (upside down) when adding the refrigerant.
13. The air in the gauge hoses needs to be purged out. Use the pressure from the system to purge the low side line, loosen the connection on the manifold for a second. Next open the valve on the refrigerant container to pressurize the line, now loosen that hose at the manifold for a second and purge that line.
14. Set the refrigerant container on an electronic charging scale and record the weight or zero the scale depending on the scale used.
15. Next determine the refrigerant charge to be added. The total standard factory charge volume is written on the side specification label of your outdoor unit. Consider additional volume for extended line sets.
16. Refrigerant can now be added to the system. The first step will be performed when the system is powered off entirely. Open the low pressure valve on the gauge manifold set to start charging the unit with liquid refrigerant, Please remember to nurse the refrigerant in slowly by controlling the low pressure valve at the Low side of your gauge manifold (open for 3 seconds and close for 10 seconds). Keep track of the refrigerant being added to the system (do not overcharge the system).
17. If the system stops accepting refrigerant before the entire intended volume is charged, close the low pressure valve on the Low pressure side of your manifold. Wait for 15 minutes and open Low pressure side of your manifold and try again, repeat this several times until no more or only very little refrigerant can be charged this way.
18. Close the Low pressure side of your manifold. Start the system with all indoor units attached running in cooling mode and lower the set points on each of their controllers to the minimum setting so the system will not shut off during the procedure.

19. Open the low pressure valve on the gauge manifold set to start charging the unit with liquid refrigerant for the remaining amount. Please remember to nurse the refrigerant in slowly by controlling the low pressure valve at the Low side of your gauge manifold (open for 3 seconds and close for 10 seconds). Keep track of the refrigerant being added into the system until the entire intended volume is charged. (do not overcharge the system).
20. The correct charge has been added to the system close the low pressure valve on the gauge manifold set and record the operating pressure. The system is now charged and the unit can be shut off. Close the valve on the refrigerant container and disconnect the hose from the manifold set, also disconnect the hose from the 3 way valve and replace and torque all caps.
21. Be sure to use a torque wrench to tighten the service port cap to a torque 18N·m (13.27 ft·lbs).

Always leak check after servicing the refrigerant system.

5.6 Procedure to remove, replace or service the refrigeration circuit of an indoor unit by Pumping down the system (isolating the refrigerant charge in the condensing unit):

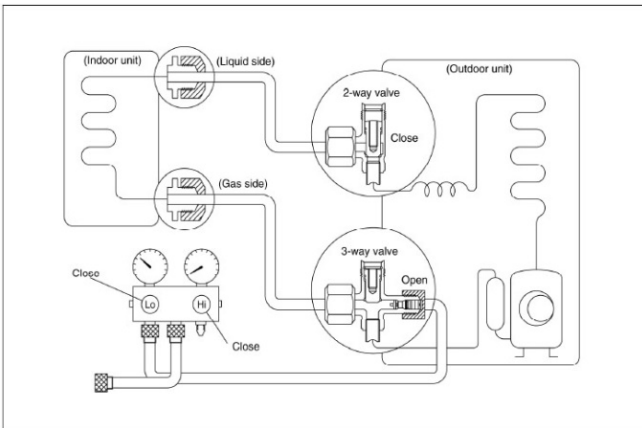

Procedure:

1. With all indoor units are running in cooling mode and their controllers are set to a low setting, remove all brass dust caps from the 3-way (Gas) and 2-way (Liquid) valves of the circuit of the indoor unit that is to be removed.
2. Assure the Low and High side valves of your gauge manifold set are both closed. Attach the low pressure hose of the manifold gauge to the 3-way (Gas) service valve port of that circuit. Purge the air from that hose by loosening the hose where it connects to the gauge manifold for a second. **Be sure to record the operating pressure**, you will need to know this when you complete the service on the indoor unit and restart the system. Now get prepared to close both 3-way (Gas) and 2-way (Liquid) valves on the unit. Also be prepared to shut the power off to the outdoor unit entirely.

3. While the system is running, first close the 2-way (Liquid) valve entirely and monitor the low pressure gauge. The pressure will start to drop quickly.
4. Keep operating the unit in the cooling mode until pressure reading on the low pressure gauge of the manifold drops to zero. At this moment, quickly close the 3-way (Gas) valve and then immediately disconnect the power to the outdoor unit. Running the compressor in a vacuum for a long time could damage the motor windings. Note that units with extended lines and additional refrigerant charge may not be able to pump down the line entirely. This is because the outdoor unit can only store a certain amount of refrigerant and this is normal (the amperage of the compressor will have to be monitored in this case). There may be little pressure left in the system. This is normal. The indoor unit is now ready to be removed and serviced.
5. Remember to evacuate / vacuum the circuit after the indoor unit is reinstalled as per the procedures covered above entirely. Check for leaks as stated above for new installations. Open both 3-way (Gas) and 2-way (Liquid) valves to release the refrigerant to the serviced circuit. Test for leaks again and proper operation. If you notice less pressure reading than recorded before the removal of the indoor unit, top off with a little additional refrigerant.

5.7 Evacuation after servicing the outdoor unit refrigeration circuit

SEE PARAGRAPH 5.5 AND FOLLOW THE SAME PROCEDURE.

NOTE: Frequent servicing and attachment of hoses to the service ports, may damage the seals of the Schrader valves inside of those service ports. Always check for leaks at each of the service ports after the gauge manifold hose is disconnected from that port. If you notice a leak at the service port, the Schrader valve core will need to be replaced. There is a special tool that can be used to replace the Schrader valve core without losing refrigerant. Refer this to your service company.

Refrigerant is Toxic and can create serious frost bites on your skin. Always assure to wear safety gear to protect your skin and eyes. Seek medical assistance in case of accidents.

Most installations and service are regulated by local regulations and building codes. Some or most of the work outlines herein may require proper permitting from the building department. Always assure to follow all applicable rules and regulations.

6. Electronic Function

6.1 Abbreviation

T1: Indoor ambient temperature

T2: Coil temperature of indoor heat exchanger at middle circuit.

T2B: Coil temperature of indoor heat exchanger at outlet. (This sensor is located in the outdoor unit)

T3: Pipe temperature of outdoor heat exchanger

T4: Outdoor ambient temperature

T5: Compressor discharge temperature

6.2 Electric control working environment.

6.2.1 Input voltage: 230V.

6.2.2 Input power frequency: 60Hz.

6.2.3 Indoor fan normal working amp. is less than 1A.

6.2.4 Outdoor fan. Normal working amp. is less than 1.5A.

6.2.5 Four-way valve normal working amp. is less than 1A.

6.3 Main Protection

6.3.1 Three Minute Delay at restart of the compressor.

---- 1 min delay for the 1st time start-up and 3 minute delay for all subsequent starts.

6.3.2 Temperature protection of compressor discharge.

As the compressor discharge temperature rises, the running frequency will be limited as per the following rules:

----If 105°C (221°F) $\leq T5 < 110^{\circ}\text{C}$ (230°F), keep the current frequency.

----If the temperature increases and $T5 \geq 110^{\circ}\text{C}$ (230°F), decrease the frequency to the next lower level every 2 minutes till reaching F1.

---If $T5 \geq 115^{\circ}\text{C}$ (239°F) for 10 seconds, the compressor will stop and restart when $T5 < 90^{\circ}\text{C}$ (194°F).

6.3.3 Fan Speed is out of control.

---- When outdoor fan speed is lower than 100RPM or higher than 2400RPM for 60 seconds, the system stops and LED displays E8 failure.

6.3.4 Inverter module Protection.

----Inverter module protection safeguards the system against current, voltage and temperature abnormalities. If these protections are triggered, the corresponding code will display on indoor unit LED and system will stop. The unit will recover after the cause of the error disappears, and following a minimum 3 minute time delay.

6.3.5 Low voltage protection

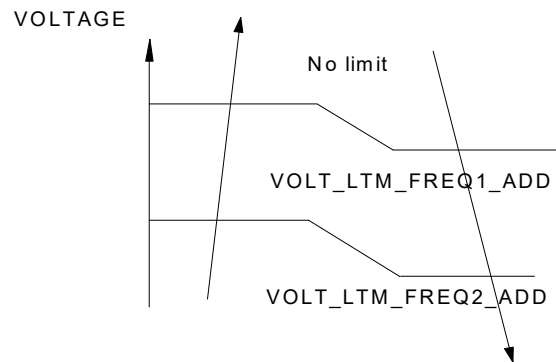

Note: if the low voltage protection is triggered and not restored within 3minutes, the system will keep the protection active after the restart.

6.3.6 Compressor current limit protection

Temperature interval.of current limit is same as the range of the T4 limited frequency.

Cooling mode:

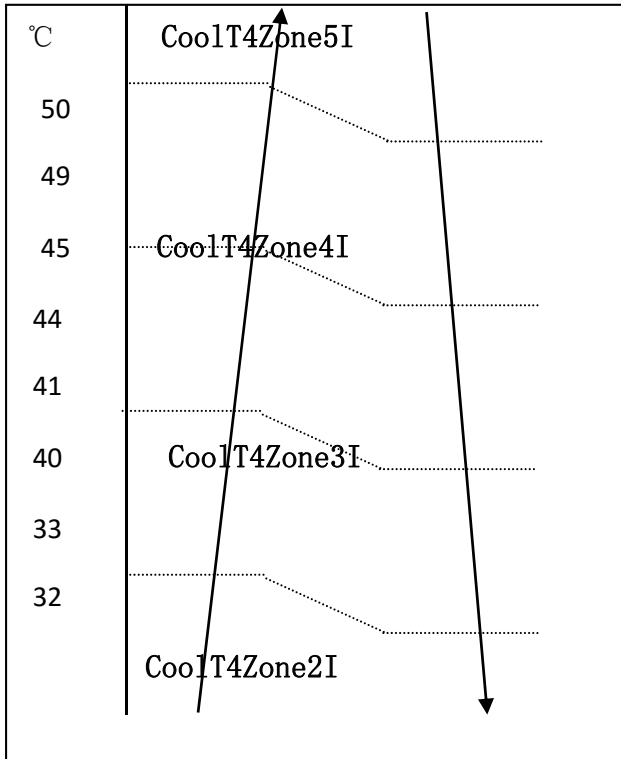

CoolReturnI	The difference between limit current and quit current.
CoolT4Zone5I	Cooling $T4 \geq 50^{\circ}\text{C}$ limit current value
CoolT4Zone4I	Cooling $49 > T4 \geq 45^{\circ}\text{C}$ limit current value
CoolT4Zone3I	Cooling $44 > T4 \geq 41^{\circ}\text{C}$ limit current value
CoolT4Zone2I	Cooling $40 > T4 \geq 33^{\circ}\text{C}$ limit current value
CoolT4Zone1I	Cooling $32 > T4^{\circ}\text{C}$ limit current value
CoolStopI	Cooling stop protection current value

Heating mode:

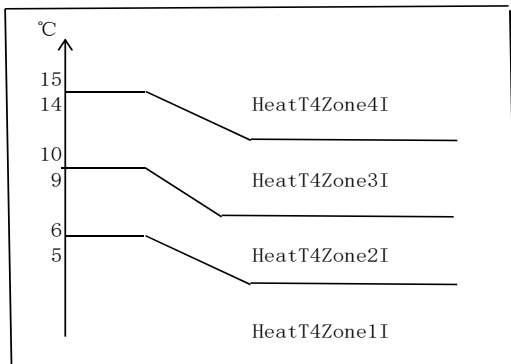

HeatReturnI	The difference between limit current and quit current.
HeatT4Zone4I	Heating $T4 \geq 15^{\circ}\text{C}$ limit current value

HeatT4Zone3I	Heating $14 > T4 \geq 10^{\circ}\text{C}$ limit current value
HeatT4Zone2I	Heating $9 > T4 \geq 6^{\circ}\text{C}$ limit current value
HeatT4Zone1I	Heating $5 > T4$ limit current value
HeatStopI	Heating stop protection current value

6.3.7 Indoor / outdoor unit communication protection

If the indoor units cannot receive the feedback signal from the outdoor units for 2 minutes, the system will stop and display the failure.

6.3.8 High condenser coil temp. protection.

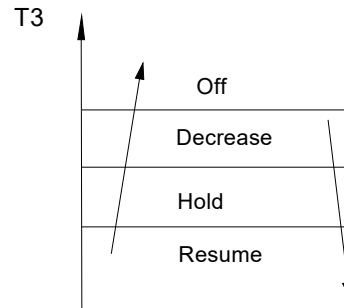

6.3.9 Outdoor unit freezing protection

When $T2 < 4^{\circ}\text{C}$ for 250 seconds or $T2 < 0^{\circ}\text{C}$, the indoor unit capacity demand will be zero and resume to normal when $T2 > 8^{\circ}\text{C}$ and the duration of protection is no less than 3 minutes.

6.3.10 Oil return

Running rules:

1. If the compressor frequency stays lower than setting frequency for setting time, the system will rise the frequency to the setting frequency for setting time and then resume to former frequency.
2. The EXV will keep 300p while the indoor units will keep the current running mode.

If the outdoor ambient is higher than setting frequency during the oil return cycle, the system will quit oil return cycle.

6.3.11 Low outdoor ambient temperature protection

When compressor is off, if $T4$ is lower than -35°C .for 10s, the system will stop and display "LP" .

When compressor is on, if $T4$ is lower than -40°C .for 10s, the system will stop and display "LP" .

When $T4$ is not lower than -32°C .for 10s, the unit will exit this protection.

6.4 Control and Functions

6.4.1 Capacity Request Calculation

Total capacity Request = $\Sigma(\text{Norm code} \times \text{HP}) / 10 + \text{correction}$

Cooling mode:

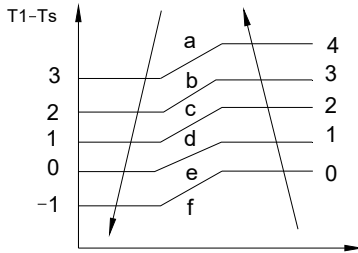

Capacity area	a	b	c	d	e	f
Norm code (N)	3	2	1.5	1	0.5	0

Model	9K	12K	18K	24K
HP	1.0	1.2	1.5	2.5

Note: The final result is integer.

According to the final capacity request to confirm the operating frequency, as per the following table.

Frequency (Hz)	0	COO L_F1	COO L_F2	...	COOL _F24	COO L_F2 5
Amended capacity demand.	0	1	2	...	24	25

Meanwhile the maximum running frequency will be adjusted according to the outdoor ambient temp.

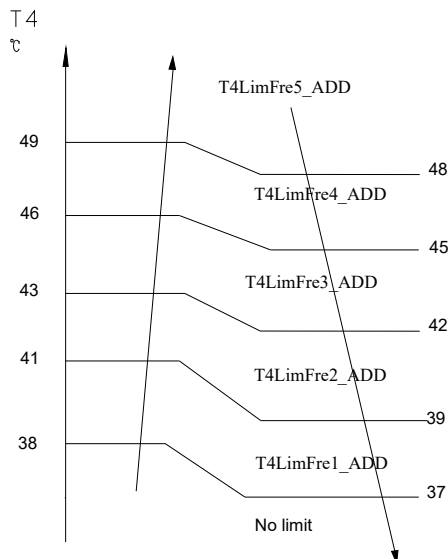

Heating mode

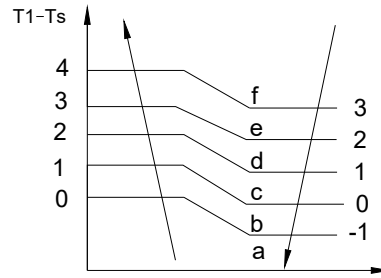

Capacity area	a	b	c	d	e	f
Norm code (N)	3	2	1.5	1	0.5	0

Model	9K	12K	18K	24K
HP	1.0	1.2	1.5	2.5

Note: The final result is an integer.

Then modify it according to T2 average (correction):

Note: Average value of T2: (Sum T2 value of all indoor units) / (number of indoor units)

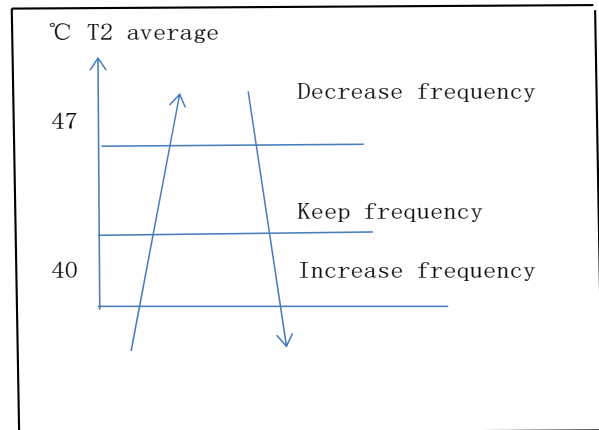

According to the final capacity request to confirm the operating frequency, as per the following table.

Frequency (Hz)	0	HEAT _F1	HEAT _F2	...	HEAT _F24	HEAT _F25
Amendatory capacity demand.	0	1	2	...	24	25

6.4.2 Defrosting control

Condition of defrosting:

If any one of the following items is satisfied, system will enter into the defrosting cycle.

After the compressor starts up and keeps running, marks the minimum value of T3 from the 10th minute to 15th minute as T30.

1) If the compressor's cumulate running time is up to 29 minutes and $T3 < TCDI1$, $T3 + T30SUBT3ONE \leq T30$.

2) If the compressor's cumulate running time is up to 35 minutes and $T3 < TCDI2$, $T3 + T30SUBT3TWO \leq T30$.

3) If the compressor's cumulate running time is up to 40 minutes and $T3 < -24^{\circ}\text{C}$ for 3 minutes.

4) If the compressor's cumulate running time is up to 120 minutes and $T3 < -15^{\circ}\text{C}$.

Condition of ending defrosting cycle:

If any one of the following items is satisfied, the defrosting will finish and the system will switch to normal heating mode.

---T3 rises to be higher than $TCDE1^{\circ}\text{C}$.

---T3 keeps to be higher than $TCDE2^{\circ}\text{C}$ for 80 seconds.

---The system has run for 10 minutes in defrosting mode.

Defrosting action:

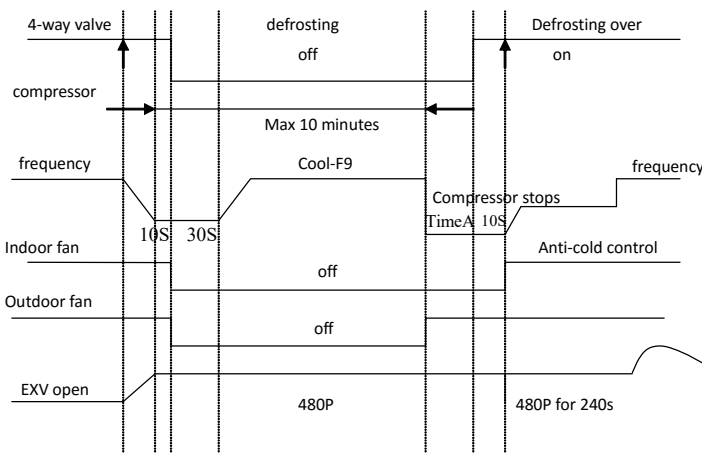

Condition of ending defrosting:

If any one of following items is satisfied, defrosting will stop and the system will switch to normal heating mode.

① $T3 > \text{TempQuitDefrost_ADD } ^{\circ}\text{C};$

② The defrosting time reaches 10min.

③ Turn to other modes or off.

6.4.3 Outdoor fan control

6.4.3.1 Cooling mode

Normally the system will choose the running fan speed according to ambient temperature:

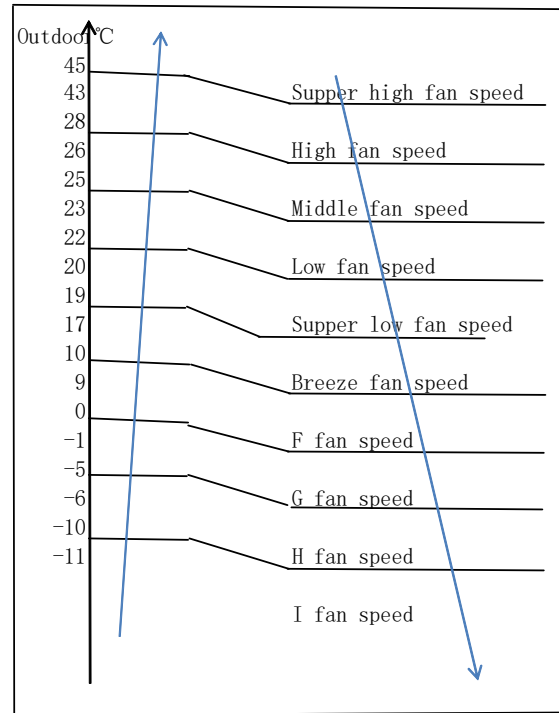

When low ambient cooling is active:

Outdoor fan speed control logic (low ambient cooling)

When $T4 < 15^{\circ}\text{C}$ (59°F) and $T3 < 30^{\circ}\text{C}$ (86°F), the unit will enter into low ambient cooling mode. The outdoor fan will choose speed according to T3.

When $T3 \geq 38^{\circ}\text{C}$ (100.4°F) or when $T4 \geq 20^{\circ}\text{C}$ (68°F), the outdoor fan will choose the speed according to T4 again.

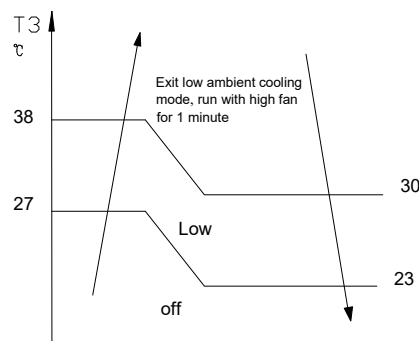

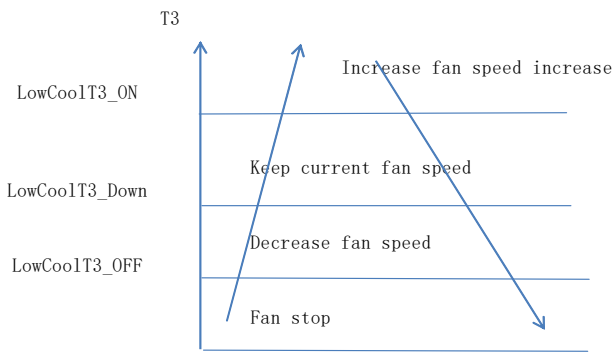

6.4.3.2 Heating mode

Normally the system will choose the running fan speed according to ambient temperature:

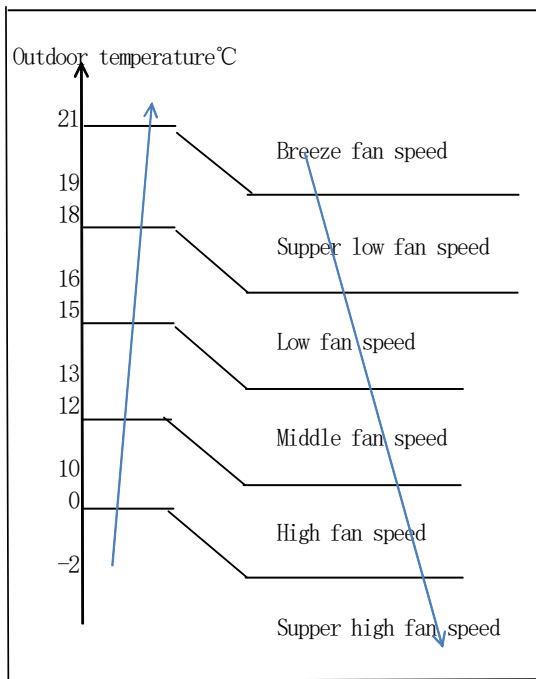

6.4.4 Electronic Expansion Valve (EXV) Control

1. EXV will be fully closed when the power is turned on. Then the EXV will be on standby with 350P open and will open to target angle after compressor starts.
2. EXV will close with -160P when compressor stops. Then EXV will be standby with 350P open and will open to target angle after compressor starts.
3. The action priority of the EXVs is A-B-C-D-E.
4. Compressor and outdoor fan start operation only after EXV is initialized.

6.4.4.1 Cooling mode

The initial open angle of EXV is depends on indoor model size, and the adjustment range is 100-400p. When the unit starts to work for 3 minutes, the outdoor will receive indoor units' capacity demand (T2B) information and calculate their average. After comparing each indoor unit's T2B with the average, the outdoor will give the following modification commands:

If the $T2B > \text{average}$, the relevant valve needs additional 16p to open;

If the $T2B = \text{average}$, the relevant valve's open range remains;

If the $T2B < \text{average}$, the relevant valve needs additional 16p to close.

This modification will be carried out every 2 minutes.

6.4.4.2 Heating mode

The initial open angle of EXV is depends on indoor model size, and the adjustment range is 150-350p. When the system starts to work for 3minutes, the outdoor unit will receive indoor units' capacity demand (T2) information and calculate their average. After comparing each indoor unit's T2 with the average, the outdoor unit gives the following modification commands:

If the $T2 > \text{average} + 2$, the relevant valve needs additional 16p to close;

If $\text{average} + 2 \geq T2 \geq \text{average} - 2$, the relevant valve's open range remains;

If the $T2 < \text{average} - 2$, the relevant valve needs additional 16p to open.

This modification will be carried out every 2 minutes.

6.4.5 Four-way valve control

In heating mode, four-way valve is activated. In defrosting, four-way valve operates according to the defrosting action. In other modes, four-way valve is deactivated. When switching from the heating mode to other modes, the four-way valve will be deactivated, after the compressor stays off for 2 minutes. In case of any failure or protection activation (not including discharge temperature protection or high and low pressure protection), four-way valve immediately deactivates.

7. Wiring Diagrams

8.1 Wiring diagram of DUAL (2) Circuit Outdoor Unit YN020GMFI22M2D

1602230000873

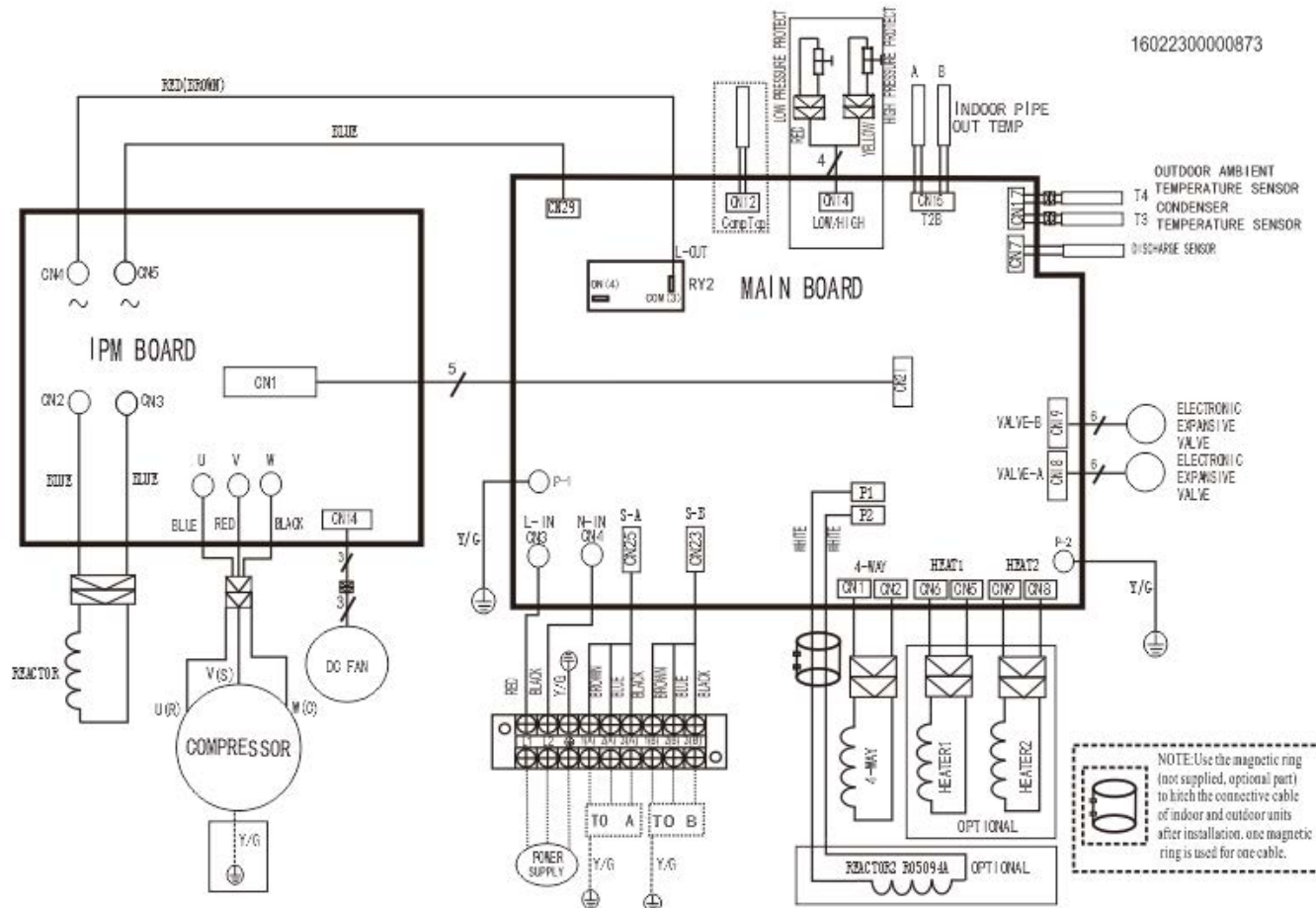

8.2 Wiring diagram of TRIPLE (3) Circuit Outdoor Unit YN030GMFI22M3D

1602230000835

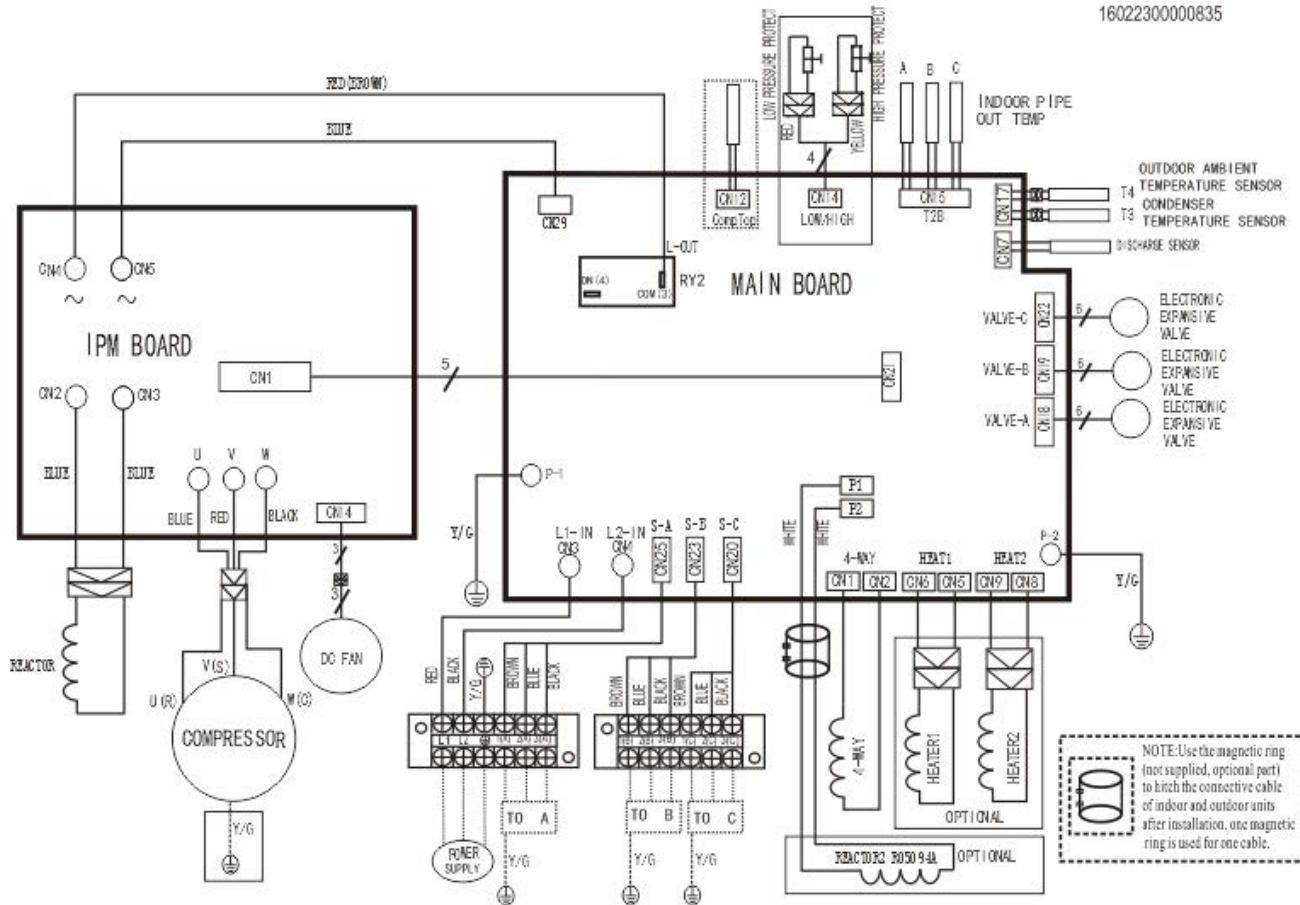

8.3 Wiring diagram of QUAD (4) Circuit Outdoor Unit YN040GMF122M4D

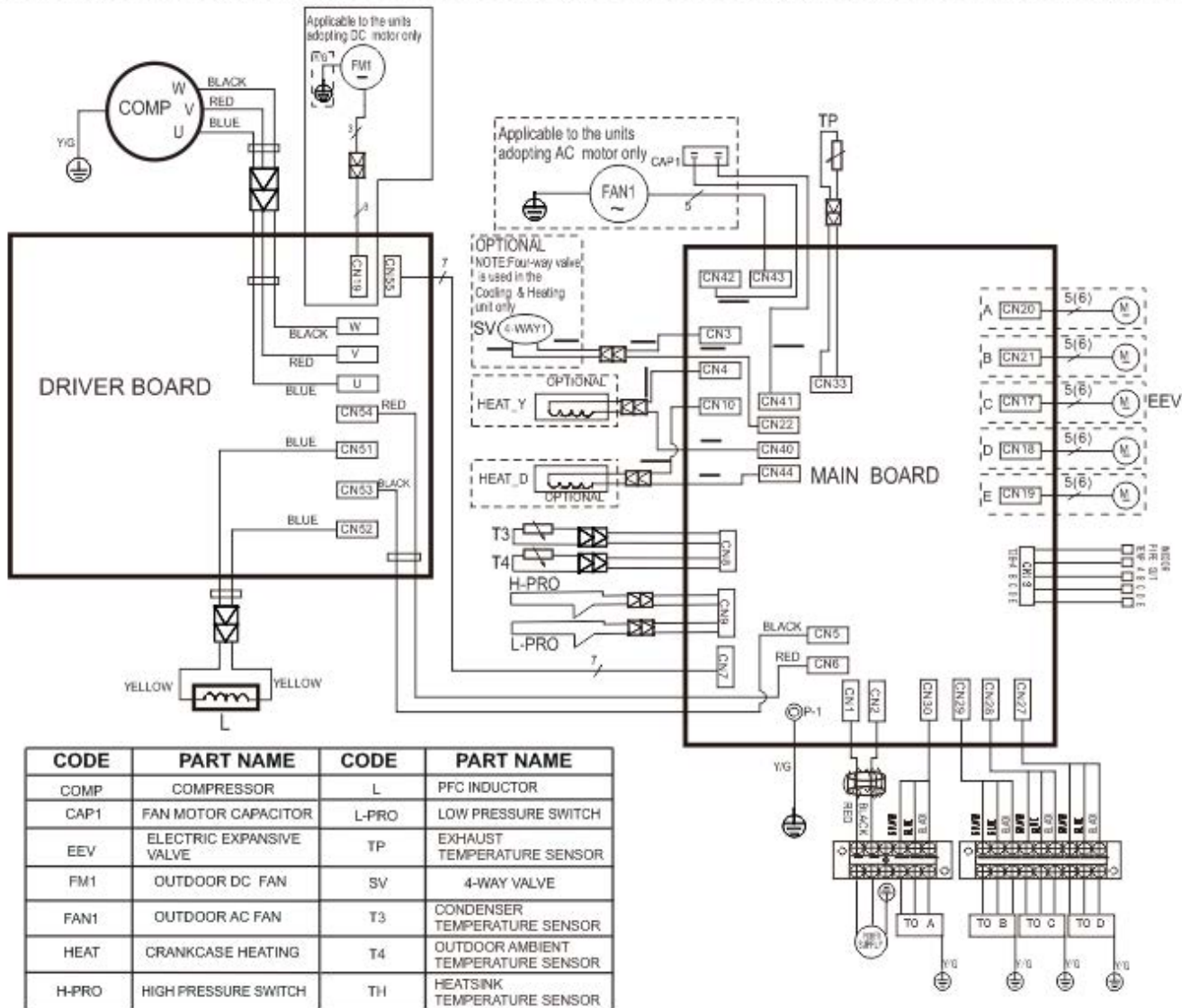

8.4 Wiring diagram of QUINT (5) Circuit Outdoor Unit YN050GMF122M5D

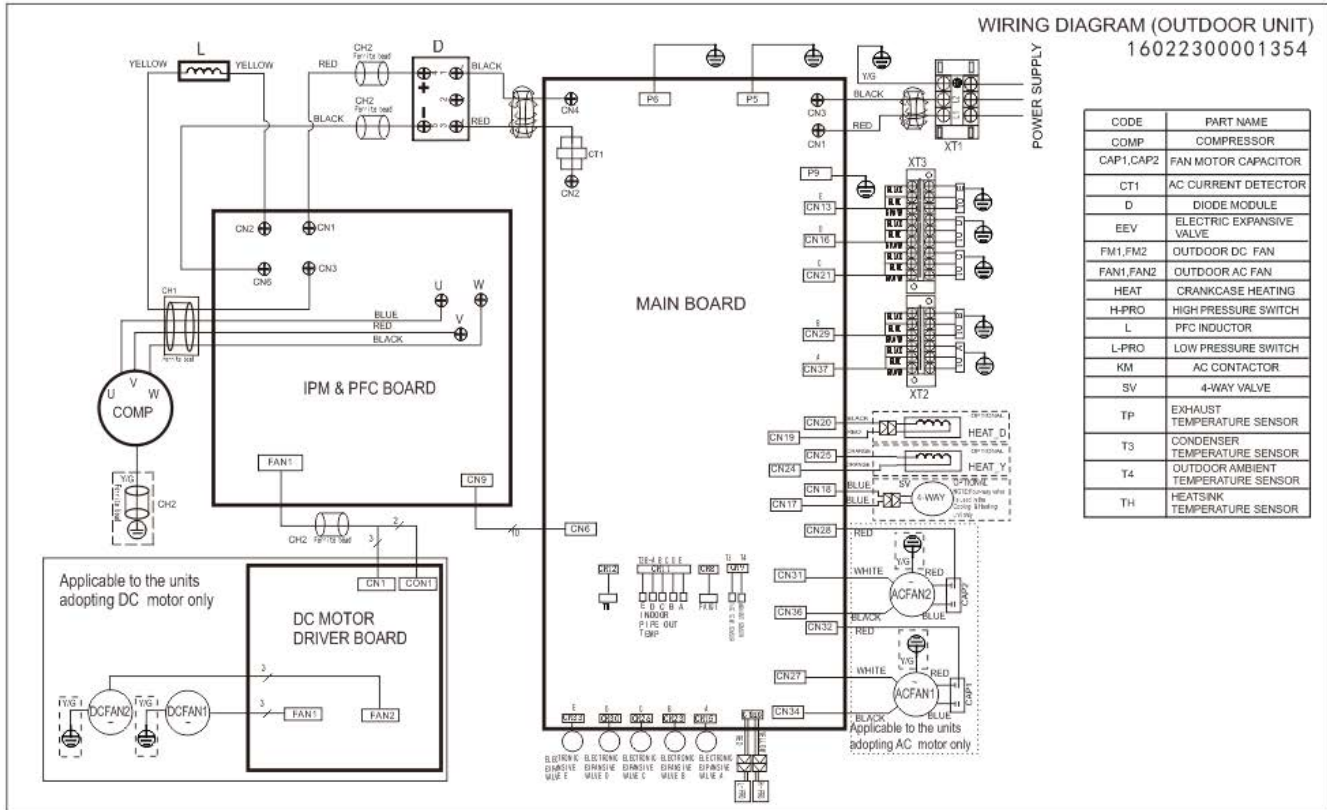

8. Troubleshooting

8.1 Safety

Because there are high power capacitors on PCB and related circuits in outdoor unit, even after shutting down the power supply, risk of electrocution still exists. Do not forget to discharge the electrical power in these capacitors.

Use a 25~40 W bulb or resistor with resistance value of about 1500 ohm to 2000 ohm to discharge the power in the capacitors.

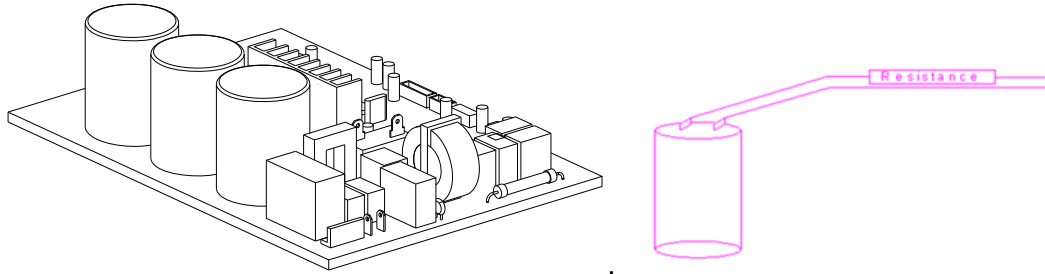

Electrolytic Capacitors

(HIGH VOLTAGE! CAUTION!)

The voltage in P3 and P4 in outdoor PCB is high voltage about 310V

The voltage in P5 and P6 in outdoor PCB is high voltage about 310V

8.2 Indoor Unit Error Display

For 2015 or earlier Floor Console Models

FB012GMFI16HLD (2015 or earlier)

Operation	Timer	De-frost	Failure
★	X	X	Indoor room temperature sensor (T1) malfunction
X	X	★	Evaporator coil temperature sensor (T2) malfunction
X	★	X	Communication malfunction between indoor and outdoor units
●	★	X	Low ambient temperature cut off in heating
★	★	X	Indoor unit EEPROM parameter error
X	★	●	Outdoor fan speed has been out of control
★	X	★	Inverter module (IPM) malfunction
★	★	★	Outdoor temperature sensor(coil sensor T3 or ambient temperature sensor T4) malfunction or Outdoor unit EEPROM parameter error
★	●	X	Compressor top high temperature protection (OLP)
★	◎	X	Compressor drive protection
★	X	●	Indoor units mode conflict
★	●	★	Indoor fan speed has been out of control
◎	X	X	In standby mode
●	◎	◎	In force cooling mode
★ flash at 5Hz, ● light, X extinguished, ◎flash at 0.5Hz			

For 2015 or earlier Concealed Duct / Cassette / Floor Ceiling Models:

RB012GMFI16HLD, RB018GMFI16HLD (2015 and earlier)

CB012GMFI16HLD, CB018GMFI16HLD (2015 and earlier)

UB012GMFI16HLD, UB018GMFI16HLD (2015 and earlier)

Operation	Timer	De-frost	Alarm	Failure	Display	ODU Error code
★	X	X	X	Indoor room temperature sensor (T1) malfunction	E0	—
X	X	★	X	Evaporator coil temperature sensor (T2) malfunction	E1	—
X	★	X	X	Communication malfunction between indoor and outdoor units	E2	E2
X	X	X	★	Water-level alarm malfunction	E3	—
★	★	X	X	Indoor unit EEPROM parameter error	E4	—
★	X	X	●	Inverter module (IPM) malfunction	E5	P6
★	●	X	X	Outdoor temperature sensor(coil sensor T3 or ambient temperature sensor T4) malfunction or Outdoor unit EEPROM parameter error	E6	E0,E4
★	●	★	X	Outdoor fan speed has been out of control	E7	E8
★	●	●	X	Indoor fan speed has been out of control	F5	—
★	●	X	●	Over-voltage or under-voltage protection	P0	E5
★	X	●	X	Compressor top high temperature protection (OLP)	P1	P0
★	★	★	X	Current overload protection	P2	P3
★	◎	X	X	Compressor drive malfunction	P4	—
★	X	●	●	Indoor units mode conflict	P5	—

★ flash at 2.5Hz, ● light, X extinguished, ◎flash at 0.5Hz

For 2015 or earlier Wall Mount Models

WB009GMFI16HLD, WB012GMFI16HLD, WB018GMFI16HLD (2015 and earlier)

De-frost	Timer	Auto	Operatio	Failure	Display
●	●	●	●	Indoor unit EEPROM parameter error	E0
★	★	★	★	Communication malfunction between indoor and outdoor units error	E1
●	●	★	★	Zero-crossing signal detection error	E2
●	●	★	★	Indoor fan speed has been out of control	E3
X	●	X	★	Outdoor temperature sensor(coil sensor T3 or ambient temperature sensor T4) malfunction or Outdoor unit EEPROM parameter error sensor	E5
●	●	●	★	Indoor room temperature sensor(room sensor T1 or coil sensor T2) malfunction	E6
★	●	★	★	Outdoor fan speed has been out of control	E7
X	X	●	★	Inverter module (IPM) malfunction	P0
X	●	●	★	Over-voltage or under-voltage protection	P1
●	X	X	★	Compressor top high temperature protection (OLP)	P2
●	X	●	★	Low ambient temperature cut off in heating	P3
●	X	★	★	Compressor drive malfunction	P4
X	●	★	★	Indoor units mode conflict	P5

For All 2016 and newer Models: Wall Mount, Concealed Duct / Cassette / Floor Console / Floor Ceiling):

1) Wall Mounted:

WS009GMFI22HLD, WS012GMFI22HLD, WS018GMFI22HLD, WS024GMFI22HLD.

2) Ceiling Concealed:

RB009GMFILD FHD, RB012GMFILD FHD, RB018GMFILD FHD, RB024GMFILD FHD.

3) Cassette:

CB009GMFILD FHD, CB012GMFILD FHD, CB018GMFILD FHD, CB024GMFILD FHD.

4) Floor Console:

FB009GMFILD FHD, FB012GMFILD FHD.

5) Floor / Ceiling:

UB018GMFILD FHD, UB024GMFILD FHD.

Operation lamp	Timer lamp	Display	LED STATUS	ODU Error
★ 1 time	X	E0	Indoor unit EEPROM parameter error	---
★ 2 times	X	E1	Communication malfunction between indoor and outdoor units	E2
★ 4 times	X	E3	Indoor fan speed malfunction	---
★ 5 times	X	E4	Indoor room temperature sensor (T1) malfunction	---
★ 6 times	X	E5	Evaporator coil temperature sensor (T2) malfunction	---
★ 8 times	X	EE	Water-level alarm malfunction	
★ 1 times	●	F0	Current overload protection	---
★ 2 times	●	F1	Outdoor ambient temperature sensor (T4) malfunction	E4
★ 3 times	●	F2	Condenser coil temperature sensor (T3) malfunction	E4
★ 4 times	●	F3	Compressor discharge temperature sensor (T5) malfunction	E4
★ 5 times	●	F4	Outdoor unit EEPROM parameter error	E0
★ 6 times	●	F5	Outdoor fan speed malfunction	E8
★ 7 times	●	F6	Indoor coil outlet pipe sensor(Located on outdoor unit low pressure valve)	---
★ 8 times	●	F7	Communication malfunction between Cassette optional lift panel and the unit.	---
★ 9 times	●	F8	Cassette optional lift panel malfunction	---
★ 10 times	●	F9	Cassette optional lift panel not closed	---
★ 1 times	★	P0	Inverter module (IPM) malfunction	P6
★ 2 times	★	P1	Over-voltage or under-voltage protection	E5
★ 3 times	★	P2	High temperature protection of IPM board	---
★4 times	★	P3	Low ambient temperature protection	LP
★ 5 times	★	P4	Compressor drive malfunction	---
★ 6 times	★	P5 (---	Indoor units mode conflict	---
★ 7 times	★	P6	Low pressure protection	P2

★ flash , ● light, X extinguished

Outdoor unit error display

YN020GMFI22M2D, YN030GMFI22M3D, YN040GMFI22M4D, YN050GMFI22M5D,

Display	LED STATUS	New indoor Error
E0	Outdoor unit EEPROM parameter error	F4
E2	Communication malfunction between indoor and outdoor units	E1
E3	Communication malfunction between IPM board and outdoor main control board	---
E4	Outdoor temperature sensor (coil sensor T3, ambient sensor T4, Compressor discharge sensor T5, indoor coil outlet pipe sensor T2B) malfunction	F2/F1/F3/F6
E5	Over-voltage or under-voltage protection	P1
E6	PFC module protection	---
E8	Outdoor fan speed malfunction	F5
F1	No. A Indoor unit coil outlet temp. sensor malfunction	---
F2	No. B Indoor unit coil outlet temp. sensor malfunction	---
F3	No. C Indoor unit coil outlet temp. sensor malfunction	---
F4	No. D Indoor unit coil outlet temp. sensor malfunction	---
F5	No. E Indoor unit coil outlet temp. sensor malfunction	---
F6	No. F Indoor unit coil outlet temp. sensor malfunction	---
P1	High pressure protection	P6
P2	Low pressure protection	P6
P3	Current overload protection	F0
P4	Temperature protection of compressor discharge	---
P5	Condenser high temperature protection	---
P6	Inverter module (IPM) malfunction	P0
LP	Low ambient temperature protection	---

8.3 Outdoor Unit Display

8.3.1 Outdoor unit point check function:

There is a pushbutton switch in the outdoor PCB as marked below (SW1).

Push the switch SW1 to check the states of unit when it is running. The digital display LED will display the following information after pushing the SW1 each time. See below table indicating the information displayed for the number sequence of presses of the button.

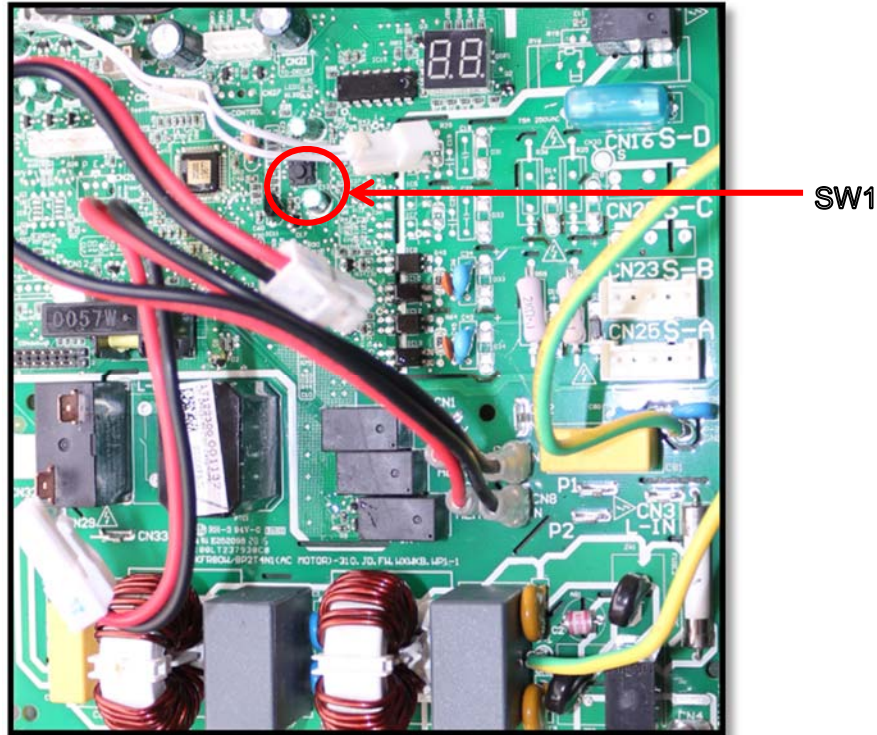

	Display	Remark										
0	Normal display	Display running frequency, running state or malfunction code										
1	Quantity of indoor units in good connection	Actual data <table border="1" style="margin-left: 20px;"> <thead> <tr> <th>Display</th> <th>Number of indoor unit</th> </tr> </thead> <tbody> <tr> <td>1</td> <td>1</td> </tr> <tr> <td>2</td> <td>2</td> </tr> <tr> <td>3</td> <td>3</td> </tr> <tr> <td>4</td> <td>4</td> </tr> </tbody> </table>	Display	Number of indoor unit	1	1	2	2	3	3	4	4
Display	Number of indoor unit											
1	1											
2	2											
3	3											
4	4											
2	Outdoor unit running mode code	Off:0, Fan only 1, Cooling:2, Heating:3, Forced cooling:4										
3	A indoor unit capacity	The capacity unit is horse power. If the indoor unit is not connected, the digital display tube will show: "—" (9K:1HP, 12K:1.2HP, 18K:1.5HP)										
4	B indoor unit capacity											
5	C indoor unit capacity											
6	D indoor unit capacity											
7	E indoor unit capacity											
8	A Indoor unit capacity demand code	Norm code*HP (9K:1HP, 12K:1.2HP, 18K:1.5HP)										
9	B Indoor unit capacity demand code											
10	C Indoor unit capacity demand code											
11	D Indoor unit capacity demand code											
12	E Indoor unit capacity demand code											
13	Outdoor unit amandatory capacity demand code	Forced cooling:7										
14	The frequency corresponding to the total indoor units amandatory capacity demand											

15	The frequency after the frequency limit		
16	The frequency sending to compressor control chip		
17	A indoor unit evaporator outlet temp.(T _{2B} A)	If the temp. is lower than -9 degree, the digital display tube will show "-9".If the temp. is higher than 70 degree, the digital display tube will show "70". If the indoor unit is not connected, the digital display tube will show: "____"	
18	B indoor unit evaporator outlet temp.(T _{2B} B)		
19	C indoor unit evaporator outlet temp.(T _{2B} C)		
20	D indoor unit evaporator outlet temp.(T _{2B} D)		
21	E indoor unit evaporator outlet temp.(T _{2B} E)		
22	A indoor unit room temp.(T ₁ A)	If the temp. is lower than 0 degree, the digital display tube will show "0".If the temp. is higher than 50 degree, the digital display tube will show "50". If the indoor unit is not connected, the digital display tube will show: "____"	
23	B indoor unit room temp.(T ₁ B)		
24	C indoor unit room temp.(T ₁ C)		
25	D indoor unit room temp.(T ₁ D)		
26	E indoor unit room temp.(T ₁ E)		
27	A indoor unit evaporator temp.(T ₂ A)	If the temp. is lower than -9 degree, the digital display tube will show "-9".If the temp. is higher than 70 degree, the digital display tube will show "70". If the indoor unit is not connected, the digital display tube will show: "____"	
28	B indoor unit evaporator temp.(T ₂ B)		
29	C indoor unit evaporator temp.(T ₂ C)		
30	D indoor unit evaporator temp.(T ₂ D)		
31	E indoor unit evaporator temp.(T ₂ E)		
32	Condenser pipe temp.(T3)		
33	Outdoor ambient temp.(T4)		
34	Compressor discharge temp.(TP)	The display value is between 30~129 degree. If the temp. is lower than 30 degree, the digital display tube will show "30".If the temp. is higher than 99 degree, the digital display tube will show single digit and tens digit. For example, the digital display tube show "0.5",it means the compressor discharge temp. is 105 degree.)	
35	AD value of current	The display value is hex number.	
36	AD value of voltage	For example ,the digital display tube show "Cd", it means AD value is 205.	
37	EXV open angle for A indoor unit	Actual data/4. If the value is higher than 99, the digital display tube will show single digit and tens digit. For example ,the digital display tube show "2.0",it means the EXV open angle is 120×4=480p.)	
38	EXV open angle for B indoor unit		
39	EXV open angle for C indoor unit		
40	EXV open angle for D indoor unit		
41	EXV open angle for E indoor unit		
42	Frequency limit symbol	Bit7	Frequency limit caused by IGBT radiator
		Bit6	Frequency limit caused by PFC
		Bit5	Frequency limit caused by T4.
		Bit4	Frequency limit caused by T2.
		Bit3	Frequency limit caused by T3.
		Bit2	Frequency limit caused by T5.
		Bit1	Frequency limit caused by current
		Bit0	Frequency limit caused by voltage
		The display value is hex number. For example, the digital display tube show 2A,then Bit5=1, Bit3=1, Bit1=1. It means frequency limit caused by T4,T3 and current.	
43	Average value of T2	(Sum T2 value of all indoor units)/(number of indoor units in good connection)	
44	Outdoor unit fan motor state	Off:0, High speed:1, Med speed:2, Low speed:3 Breeze:4, Super breeze:5	
45	The last error or protection code	00 means no malfunction and protection	
46	F indoor unit capacity		
47	F Indoor unit capacity demand code		
48	F indoor unit evaporator outlet temp.(T _{2B} F)		
49	F indoor unit room temp.(T ₁ F)		
50	F indoor unit evaporator temp.(T ₂ F)		
51	EXV open angle for F indoor unit		

8.3.2 Outdoor unit's digital display LED will display the following information except in the checking mode as described above:

- In standby , the LED displays “- -”
- During the compressor is operating, the LED display the running frequency,
- In defrosting mode, The LED displays “dF” or alternatively displays between running frequency and “dF” (each displays 0.5s)
- During compressor pre-heating, The LED displays “PH” or alternatively displays between running frequency and “PH” (each displays 0.5s)
- During the oil return process, The LED displays “RO” or alternatively displays between running frequency and “RO” (each displays 0.5s)
- In low ambient cooling mode, the LED displays “LC” or alternatively displays between running frequency and “LC” (each displays 0.5s)
- In forced cooling mode, the LED displays “FC” or alternatively displays between running frequency and “FC”(each displays 0.5s)
- When PFC module protection occurs three times within 15 minutes, the LED displays “E6” or alternatively displays between running frequency and “E6” (each displays 0.5s)
- In case of protection or malfunction, the LED displays error code or protection code.

8.3.3 Outdoor unit error display codes

Display	LED STATUS	New indoor Error
E0	Outdoor unit EEPROM parameter error	F4
E2	Communication malfunction between indoor and outdoor units	E1
E3	Communication malfunction between IPM board and outdoor main control board	---
E4	Outdoor temperature sensor (coil sensor T3,ambient sensor T4, Compressor discharge sensor T5、 indoor coil outlet pipe sensor T2B) malfunction	F2/F1/F3/F6
E5	Over-voltage or under-voltage protection	P1
E6	PFC module protection	---
E8	Outdoor fan speed malfunction	F5
F1	No. A Indoor unit coil outlet temp. sensor malfunction	---
F2	No. B Indoor unit coil outlet temp. sensor malfunction	---
F3	No. C Indoor unit coil outlet temp. sensor malfunction	---
F4	No. D Indoor unit coil outlet temp. sensor malfunction	---
F5	No. E Indoor unit coil outlet temp. sensor malfunction	---
F6	No. F Indoor unit coil outlet temp. sensor malfunction	---
P1	High pressure protection	P6
P2	Low pressure protection	P6
P3	Current overload protection	F0
P4	Temperature protection of compressor discharge	---
P5	Condenser high temperature protection	---
P6	Inverter module (IPM) malfunction	P0
LP	Low ambient temperature protection	---

8.4 Diagnosis and Solution

8.4.1 Indoor unit trouble shooting

8.4.1.1 Indoor unit EEPROM parameter error diagnosis and solution.

Malfunction decision conditions	PCB main chip does not receive feedback from EEPROM chip
	<ul style="list-style-type: none">● Installation mistake● PCB faulty

Trouble shooting:

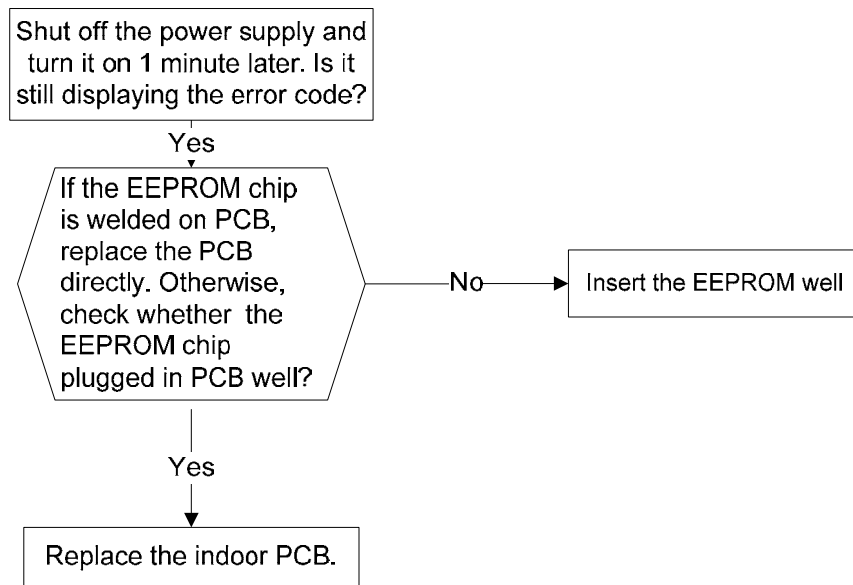

Supposed causes

EEPROM: a read-only memory whose contents can be erased and reprogrammed using a pulsed voltage.

8.4.1.2 Communication malfunction between indoor and outdoor units diagnosis and solution.

Malfunction decision conditions	Indoor unit does not receive the feedback from outdoor unit during 120 seconds.
Supposed causes	<ul style="list-style-type: none"> ● Wiring mistake ● Indoor or outdoor PCB faulty

Trouble shooting:

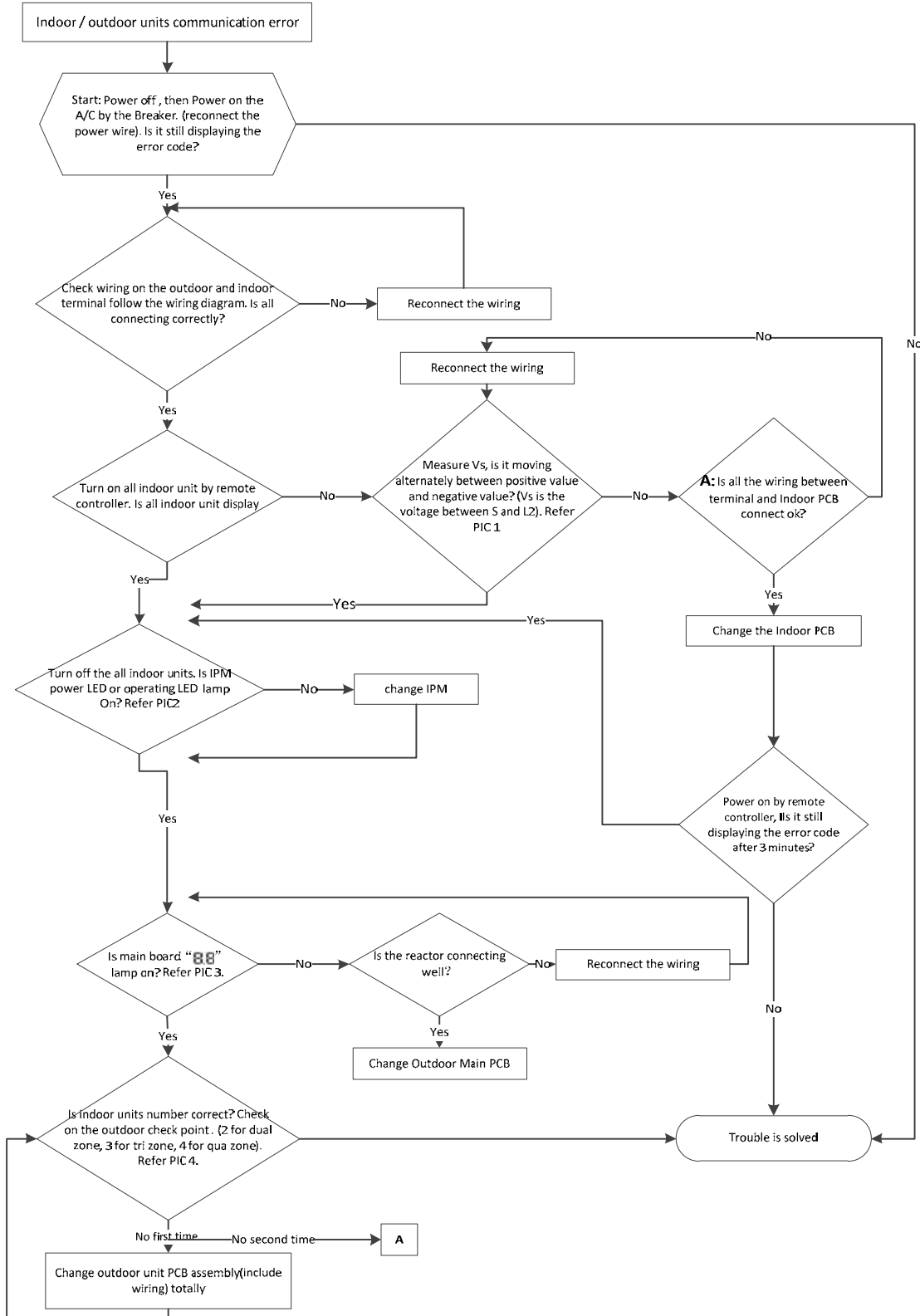

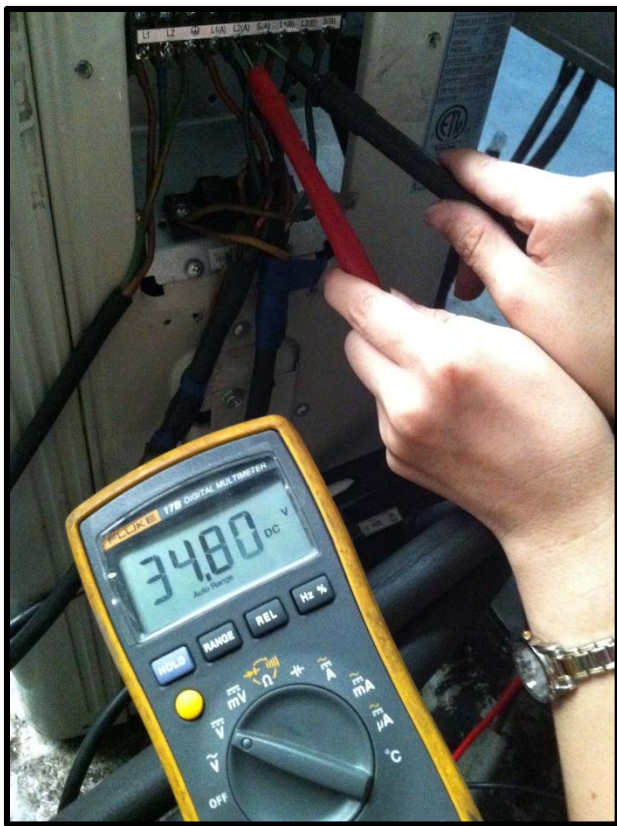

Pic 1: Use a multimeter to test the DC voltage between 2 (previously: L2) port and S port of outdoor unit. The red pin of multimeter connects with 2 (previously: L2) port while the black pin is for S port.

(Set multimeter to read DC volts)

When AC is normally running, the voltage will move alternately between positive value and negative value.

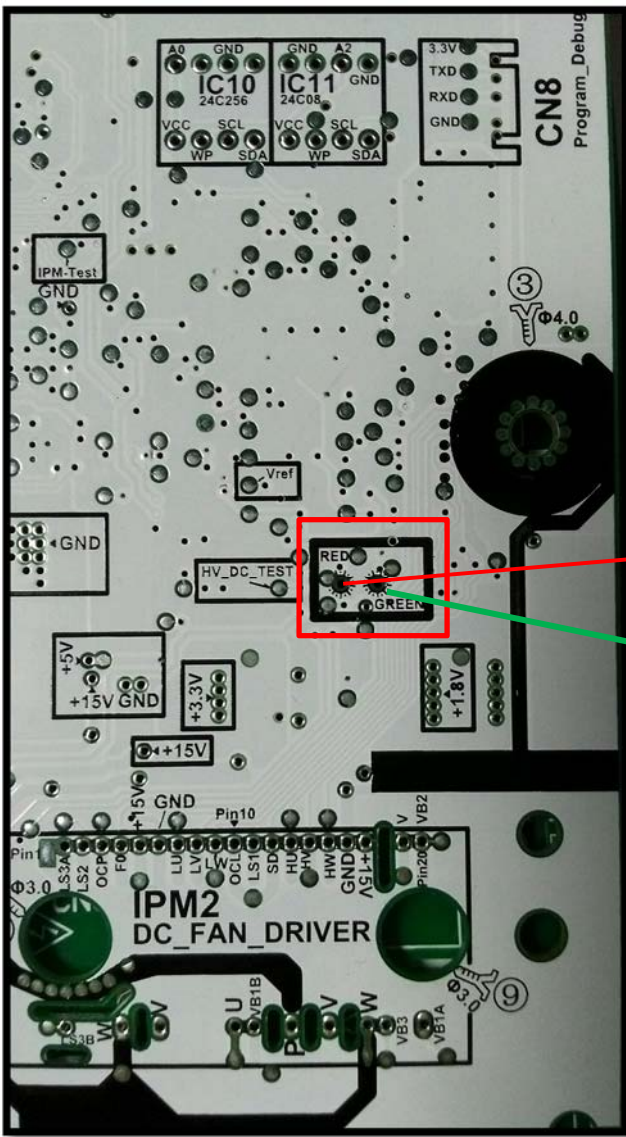

Pic 2: IPM (for 2 zone/ 3-zone)

Pic 1: Use a multimeter to test the DC voltage between 2(old: L2) port and S port of outdoor unit. The red pin of multimeter connects with 2(old: L2) port while the black pin is

for **Operating**

When **Standby** normal running, the voltage will move alternately between positive value and negative value.

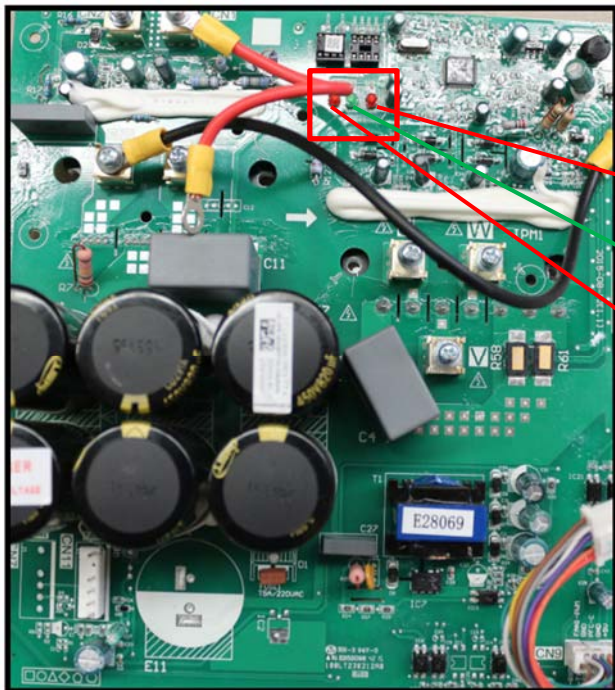

Pic 2: IPM (for5 zone)

Operating

Standby

Power



PIC3: Main board LED when power on and unit standby.

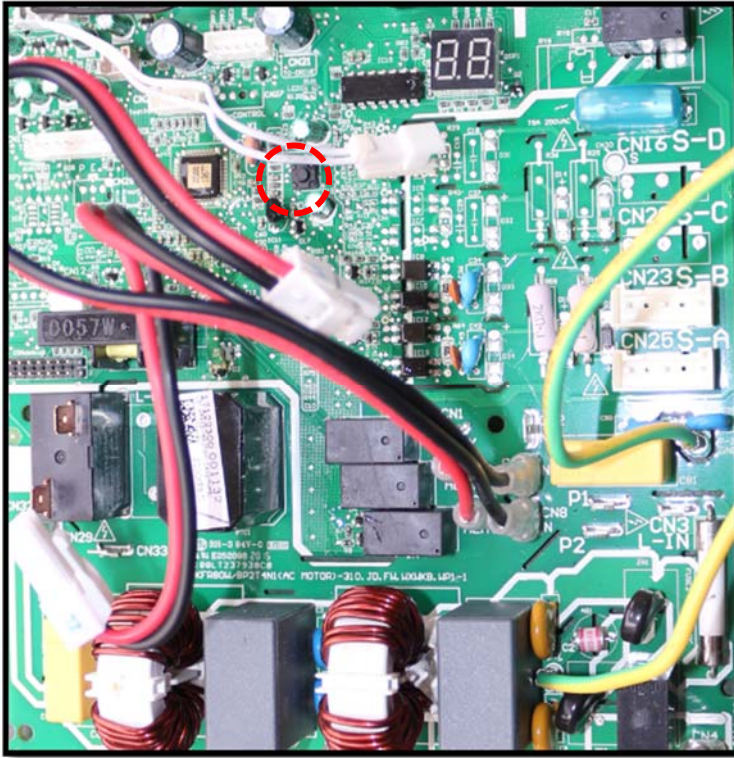

PIC4: Check point button, press 1 time for check how many indoor units are connected.

8.4.1.3 Zero-crossing signal detection error diagnosis and solution.

Malfunction decision conditions	When PCB does not receive zero crossing signal feedback for 4 minutes or the zero crossing signal time interval is abnormal.
Supposed causes	<ul style="list-style-type: none"> ● Connection mistake ● PCB faulty

Trouble shooting:

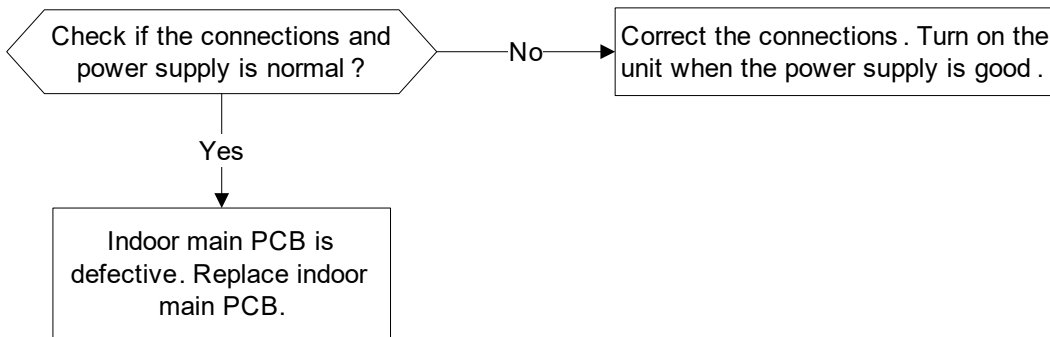

8.4.1.4 Indoor fan speed has been out of control diagnosis and solution.

Malfunction decision conditions	When indoor fan speed keeps too low (300RPM) for certain time, the unit will stop and the LED will display the failure.
Supposed causes	<ul style="list-style-type: none"> ● Wiring mistake ● Fan ass'y faulty ● Fan motor faulty ● PCB faulty

Trouble shooting:

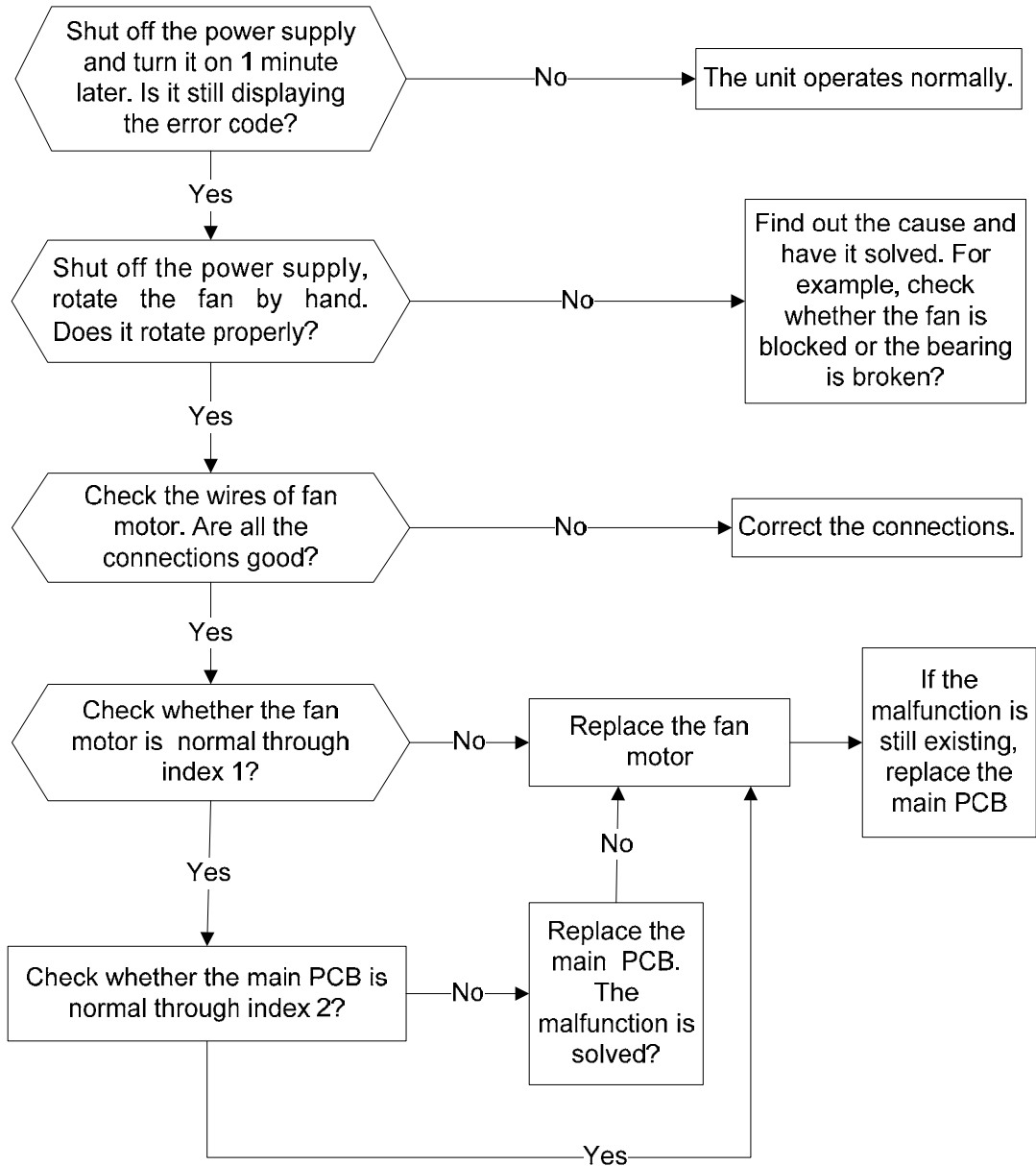

Index 1:

1: Indoor AC fan motor

Power on and set the unit running in fan mode at high fan speed. After running for 15 seconds, measure the voltage of pin1 and pin2. If the value of the voltage is less than 100V (208~240V power supply) or 50V(115V power supply), the PCB must have problems and need to be replaced.

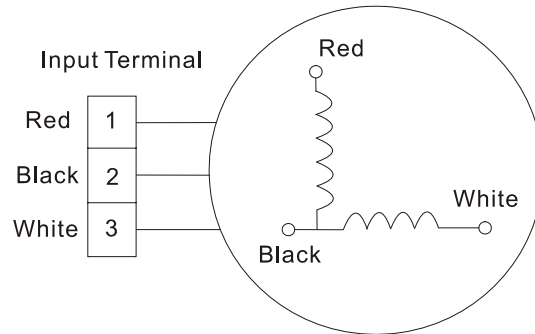

2. Indoor DC fan motor (control chip is inside fan motor)

Power on and when the unit is in standby, measure the voltage of pin1-pin3, pin4-pin3 in fan motor connector. If the value of the voltage is not in the range showing in below table, the PCB must have problems and need to be replaced.

For other models:

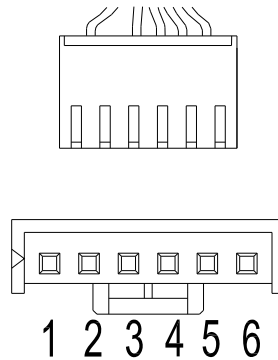

DC motor voltage input and output

NO.	Color	Signal	Voltage
1	Red	Vs/Vm	200V~380V
2	---	---	---
3	Black	GND	0V
4	White	Vcc	13.5-16.5V
5	Yellow	Vsp	0~6.5V
6	Blue	FG	13.5-16.5V

8.4.1.5 Temperature sensor malfunction diagnosis and solution.

Malfunction decision conditions	If the sampling voltage is lower than 0.06V or higher than 4.94V, the LED will display the failure.
Supposed causes	<ul style="list-style-type: none">● Wiring mistake● Sensor faulty● PCB faulty

Trouble shooting:

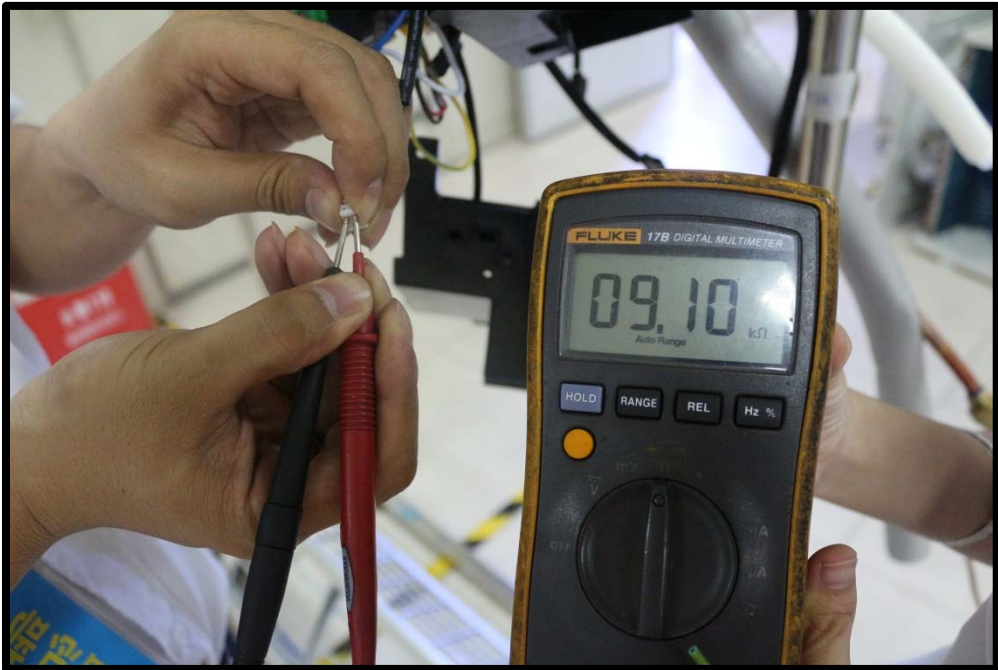
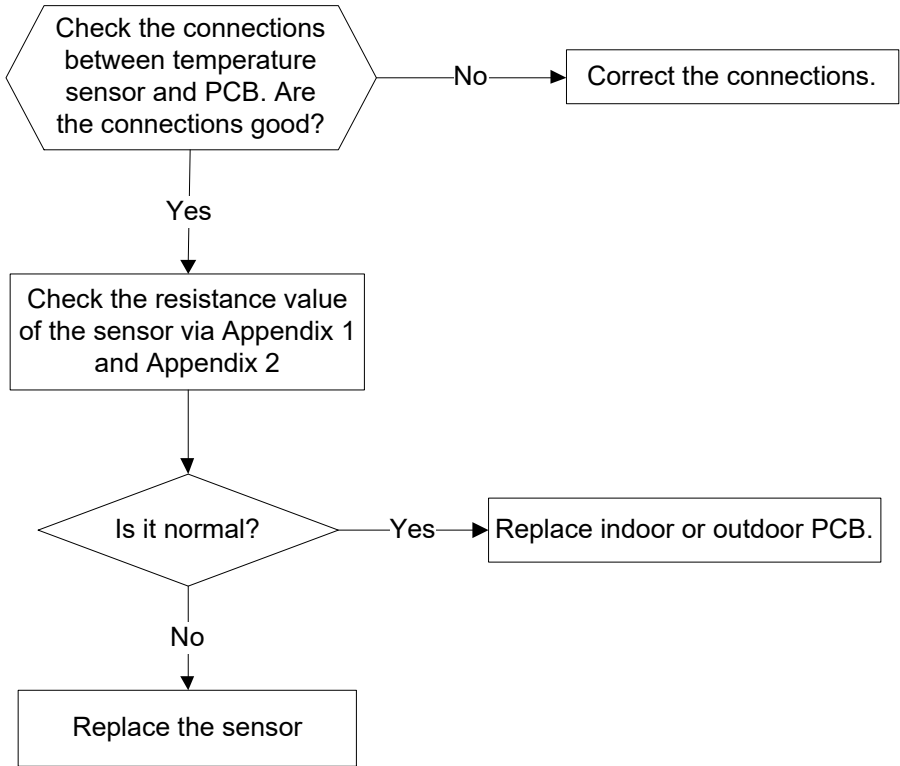

8.4.1.6 Inverter module (IPM) malfunction diagnosis and solution.

Malfunction decision conditions	When the voltage signal that IPM send to compressor drive chip is abnormal, the display LED will show “P6” and AC will turn off.
Supposed causes	<ul style="list-style-type: none"> ● Wiring mistake ● IPM malfunction ● Outdoor fan ass’y faulty ● Compressor malfunction ● Outdoor PCB faulty

Trouble shooting:

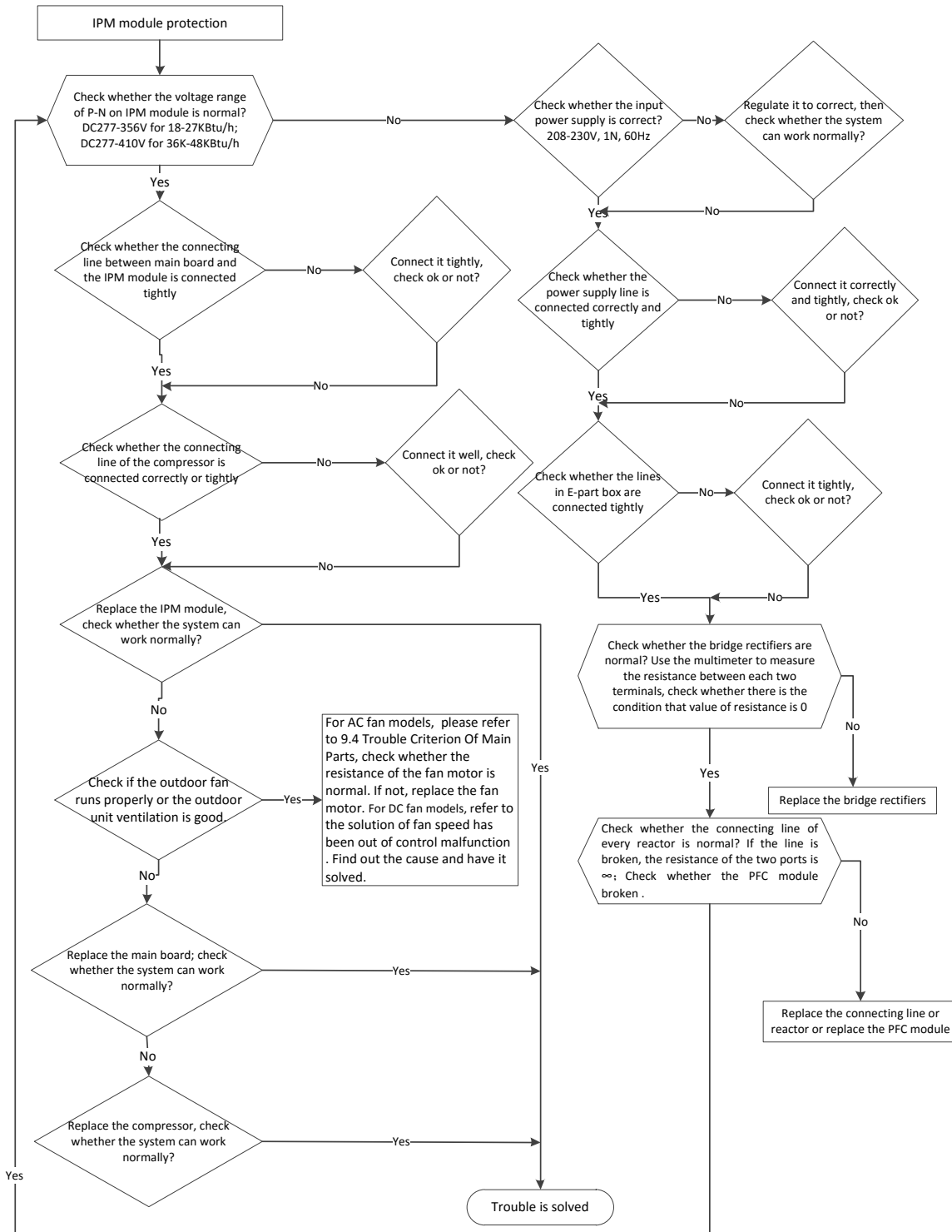

8.4.1.7 Over-voltage or under-voltage protection diagnosis and solution.

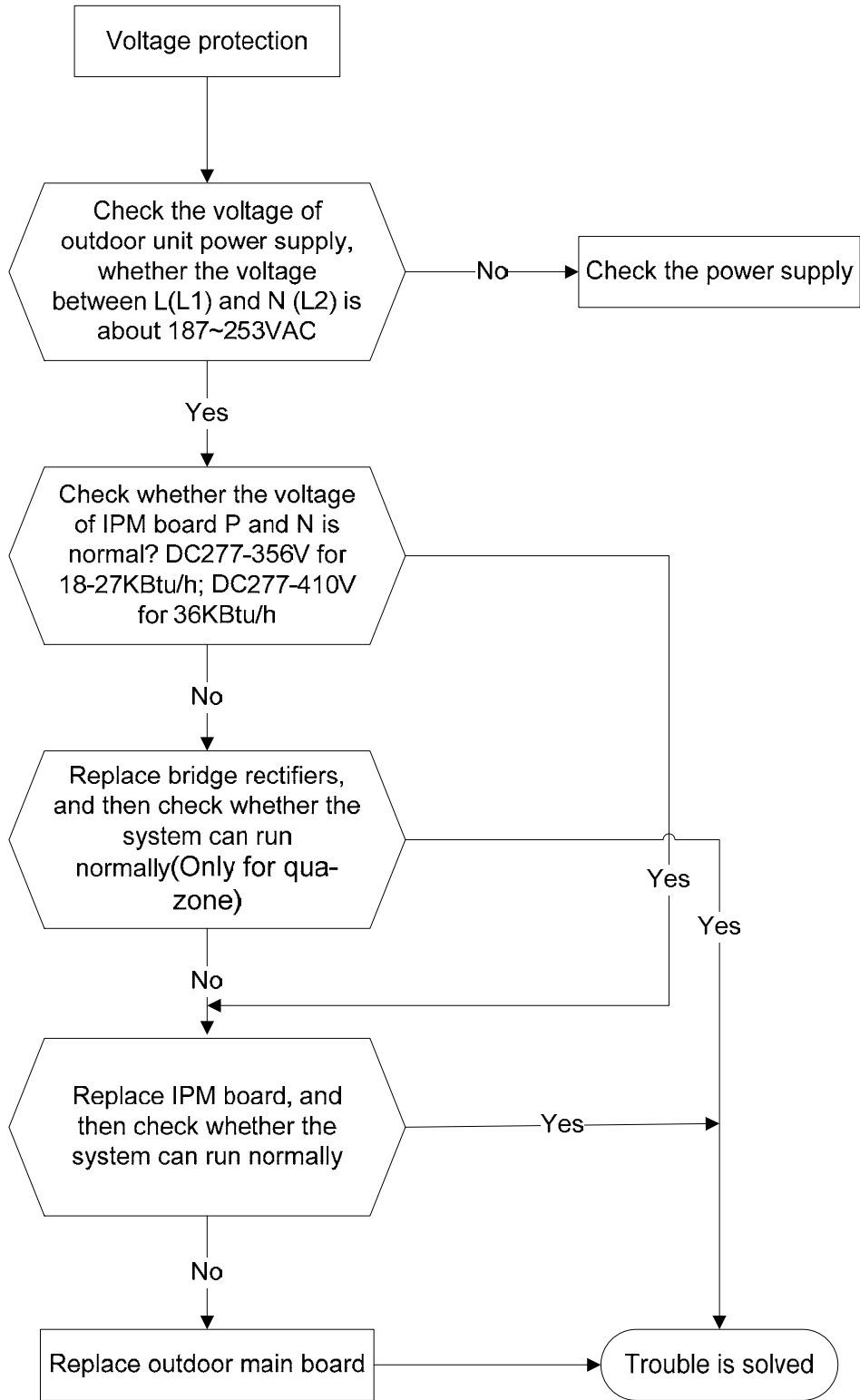

8.4.1.8 Compressor top high temperature protection (OLP) diagnosis and solution.

Malfunction decision conditions	If the sampling voltage is not 5V, the LED will display the failure.
Supposed causes	<ul style="list-style-type: none"> ● Wiring mistake ● Over load protector faulty ● System block ● Outdoor PCB faulty

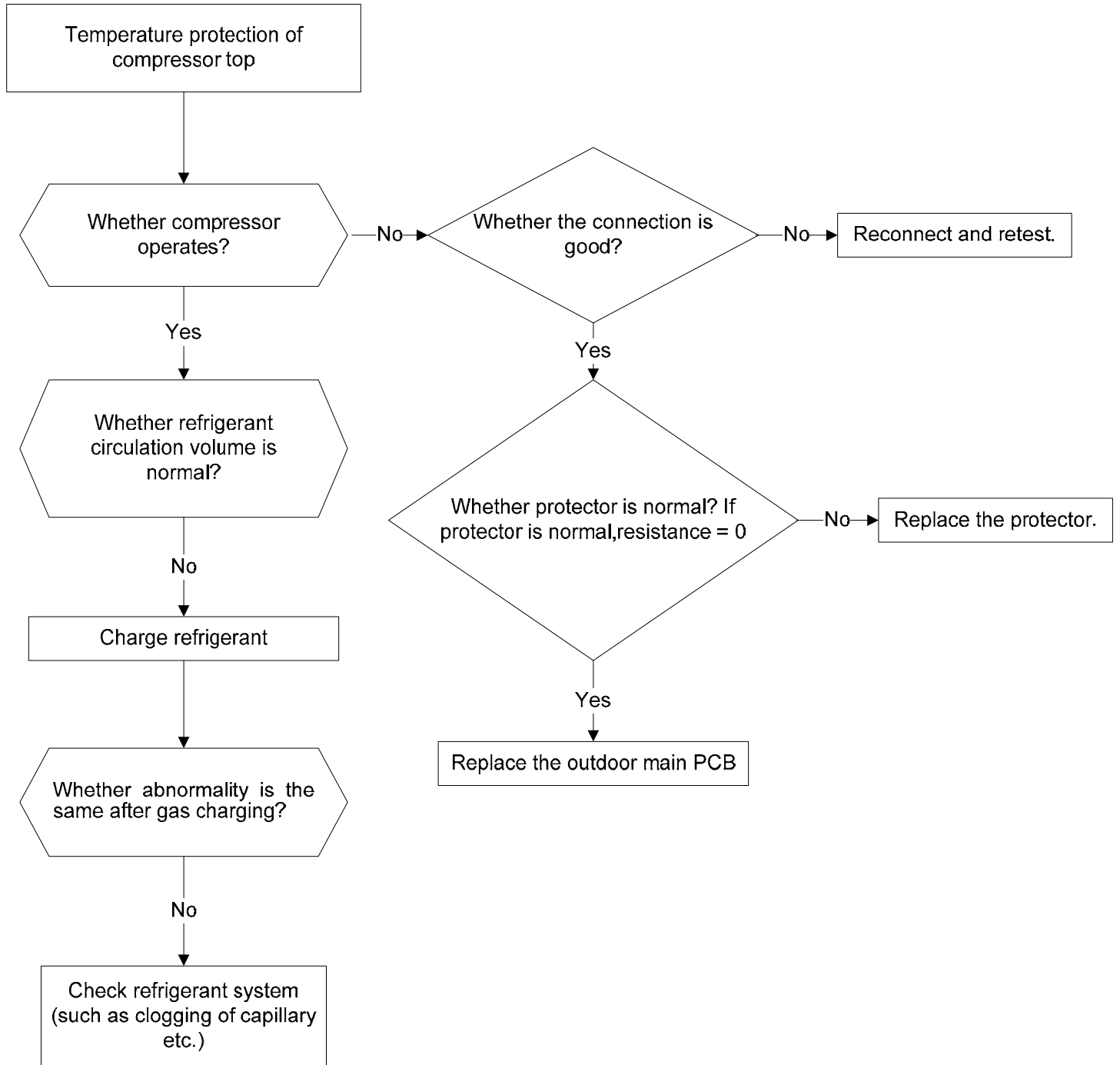

8.4.1.9 Compressor drive malfunction diagnosis and solution

The trouble shooting is same with one of IPM module protection(P0).

8.4.1.10 Water-level alarm malfunction diagnosis and solution

Malfunction decision conditions	If the sampling voltage is not 5V, the LED will display the failure.
Supposed causes	<ul style="list-style-type: none">● Wiring mistake● Water-level switch faulty● Water pump faulty● Indoor PCB faulty

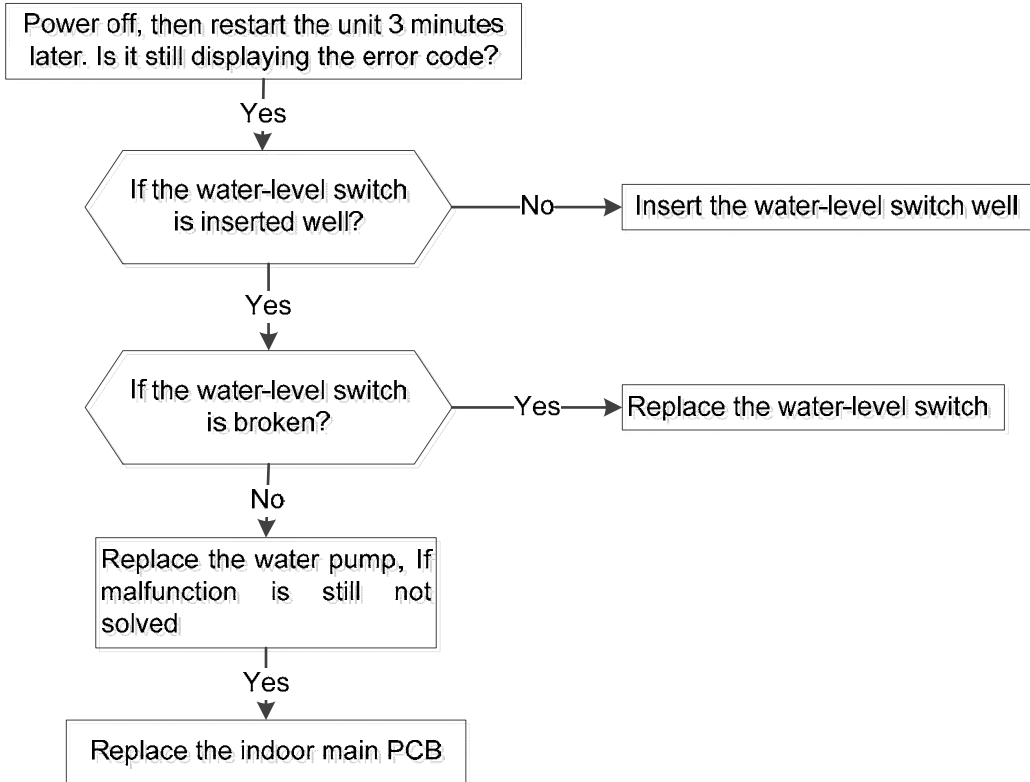

8.4.1.11 Indoor unit mode conflict (Between indoor units).

Error Code	P5 OR -- (Double Dash)
Malfunction decision conditions	The indoor units cannot work cooling mode and heating at same time. Heating mode has a priority.
Unit action	<ul style="list-style-type: none"> ● Suppose Indoor unit A working in cooling mode or fan mode, and indoor unit B is set to heating mode, then A will change to off and B will work in heating mode. ● Suppose Indoor unit A working in heating mode, and indoor unit B is set to cooling mode or fan mode, then B will change to stand by and A will be no change.

	Cooling mode	Heating Mode	Fan	Off
Cooling mode	No	Yes	No	No
Heating Mode	Yes	No	Yes	No
Fan	No	Yes	No	No
Off	No	No	No	No

No: No mode conflict;

Yes: Mode conflict

8.4.2 Outdoor unit trouble shooting

8.4.2.1 E0 (Outdoor unit EEPROM parameter error) diagnosis and solution

Error Code	E0
Malfunction decision conditions	PCB main chip does not receive feedback from EEPROM chip
Supposed causes	<ul style="list-style-type: none">● Installation mistake● PCB faulty

Trouble shooting:

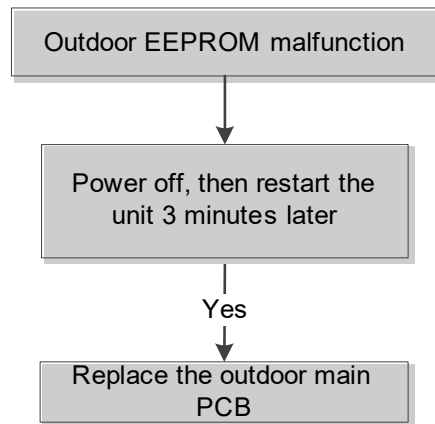

EEPROM: a read-only memory whose contents can be erased and reprogrammed using a pulsed voltage. For the location of EEPROM chip, please refer to the below photos.



8.4.2.2 E2(Communication malfunction between indoor and outdoor units) diagnosis and solution.

Error Code	E2
Malfunction decision conditions	Indoor unit does not receive the feedback from outdoor unit during 120 seconds or outdoor unit does not receive the feedback from any one indoor unit during 180 seconds.
Supposed causes	<ul style="list-style-type: none"> ● Wiring mistake ● Indoor or outdoor PCB faulty

Trouble shooting:

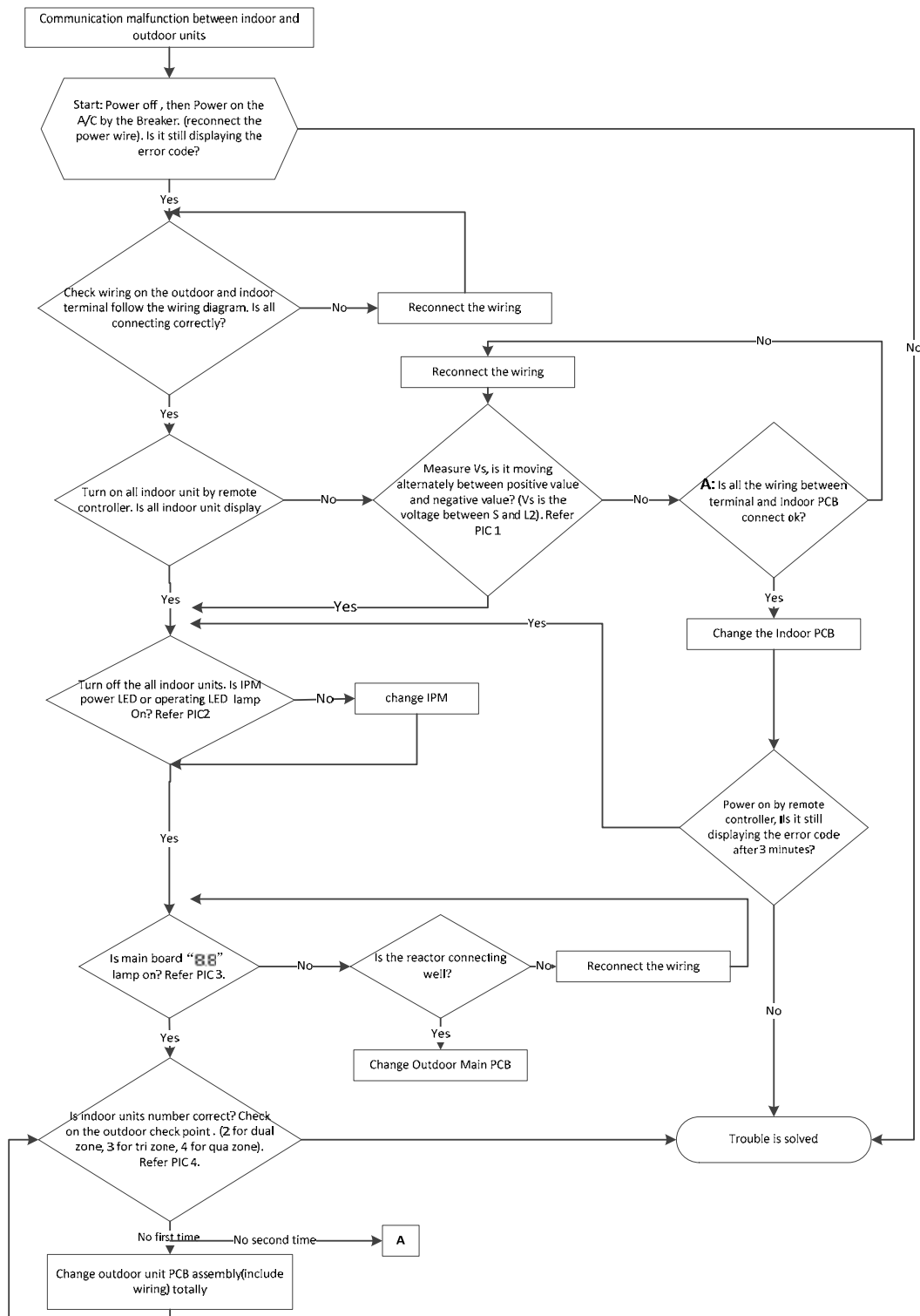



Pic 1: Use a multimeter to test the DC voltage between 2 (previously: L2) port and S port of outdoor unit. The red pin of multimeter connects with 2 (previously: L2) port while the black pin is for S port.

(Set the multimeter to read DC volts

When AC is normal running, the voltage will move alternately between positive value and negative value.

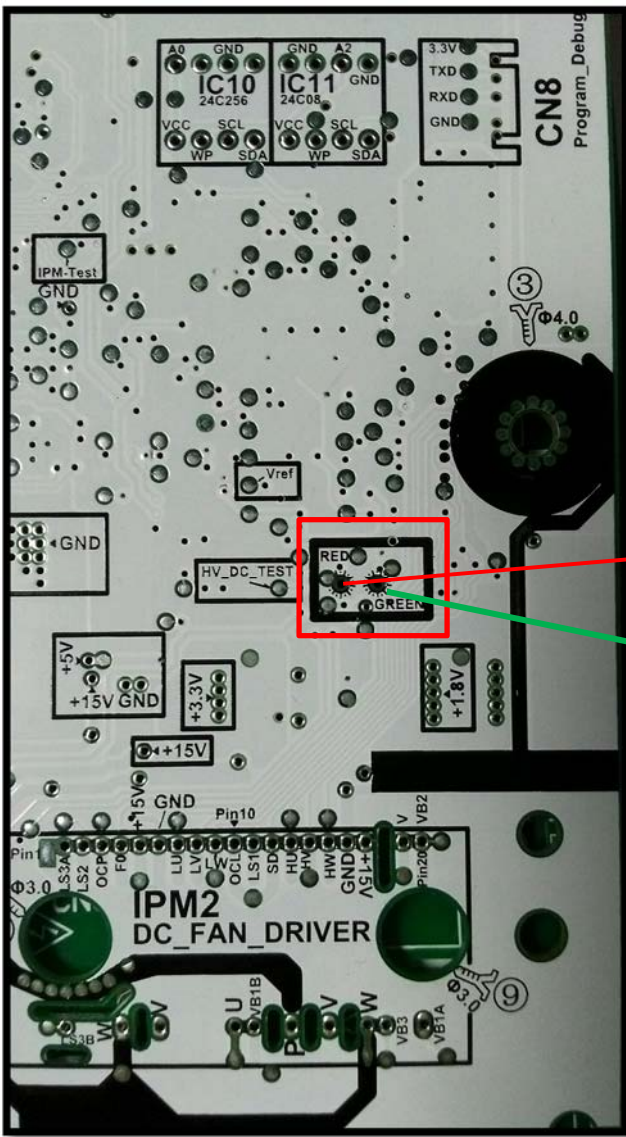

Pic 2: IPM board (for 2 zone/ 3-zone)

Operating

Standby

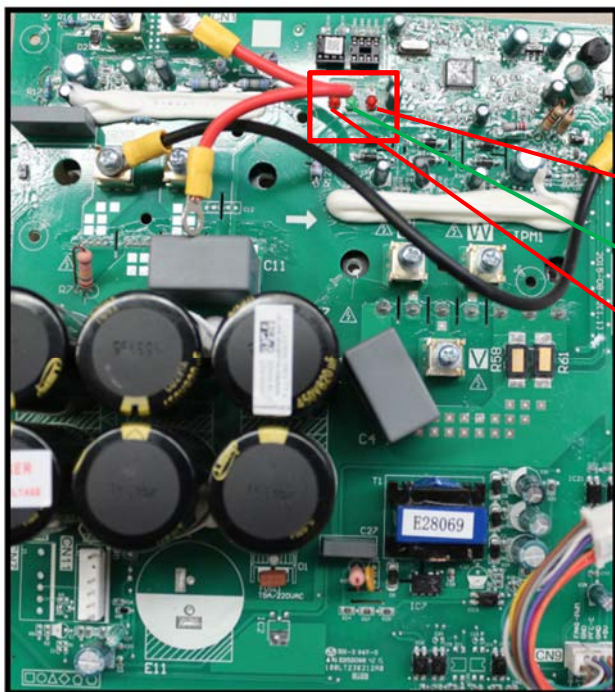

Pic 2: IPM (for5 zone)

Operating

Standby

Power



PIC3: Main board LED when power on and unit standby.

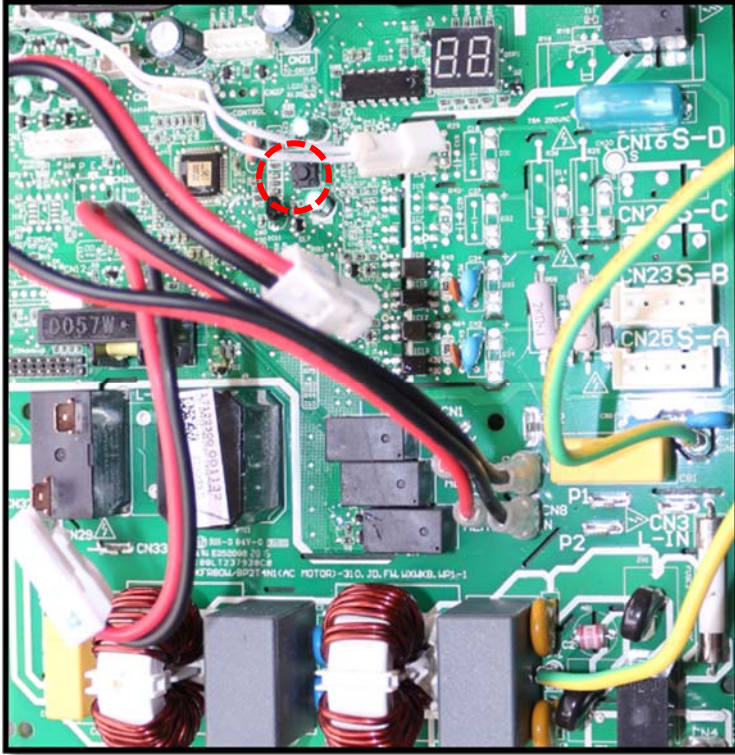

PIC 4: Check point button, press 1 time for check how many indoor units are connected.

8.4.2.3 E3 (Communication malfunction between IPM board and outdoor main control board)

diagnosis

Error Code	E3
Malfunction decision conditions	PCB main chip does not receive feedback from IPM module during 60 seconds.
Supposed causes	<ul style="list-style-type: none"> ● Wiring mistake ● PCB faulty

Trouble shooting:

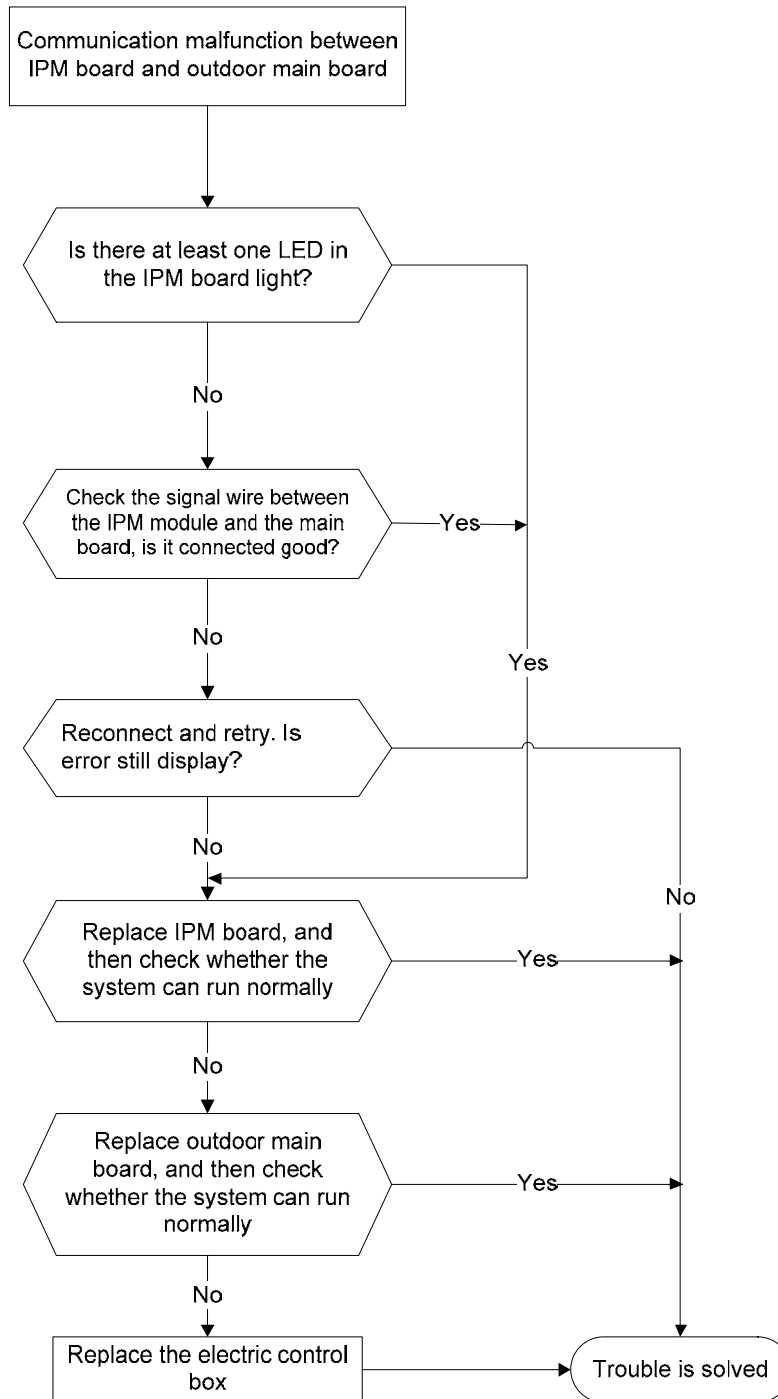

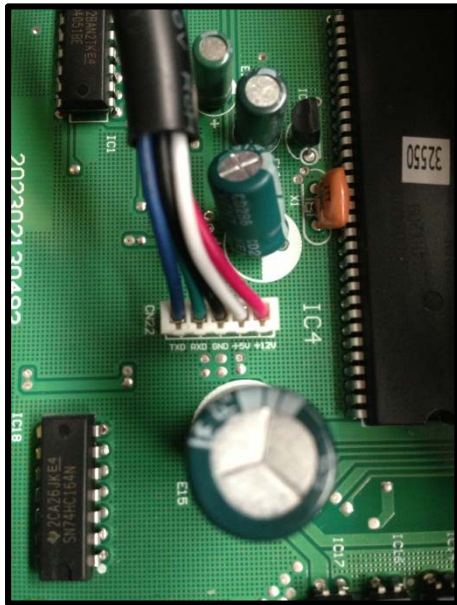

Remark:

Use a multimeter to test the DC voltage between black pin and white pin of signal wire. The normal value should be around 5V.

Use a multimeter to test the DC voltage between black pin and red pin of signal wire. The normal value should be around 12V.

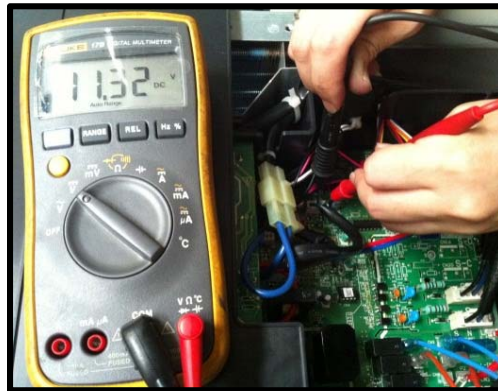
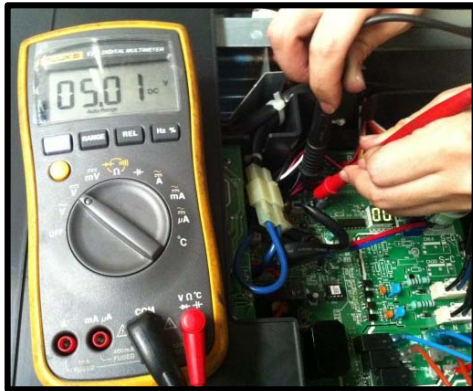

8.4.2.4 E4 (Outdoor temperature sensor (coil sensor T3, ambient sensor T4, Compressor discharge sensor T5, indoor coil outlet pipe sensor T2B) malfunction) diagnosis and solution F1/F2/F3/F4/F5 (No.A,B,C,D,E Indoor unit coil outlet temp. sensor malfunction) diagnosis and solution.

Error Code	E4/F1/F2/F3/F4/F5
Malfunction decision conditions	If the sampling voltage is lower than 0.06V or higher than 4.94V, the LED will display the failure.
Supposed causes	<ul style="list-style-type: none"> ● Wiring mistake ● Sensor faulty ● PCB faulty

Trouble shooting:

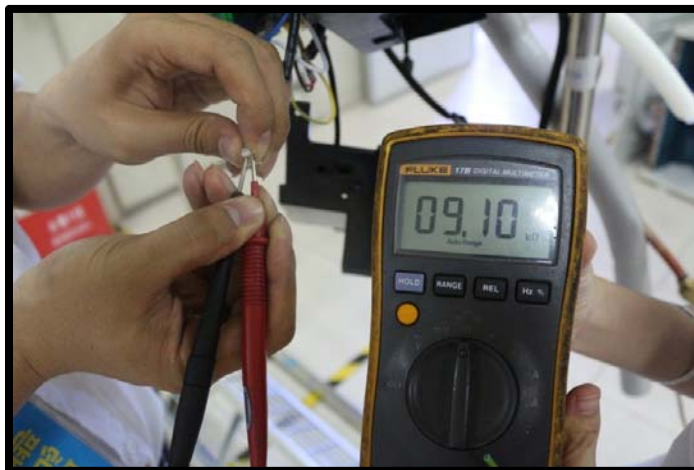
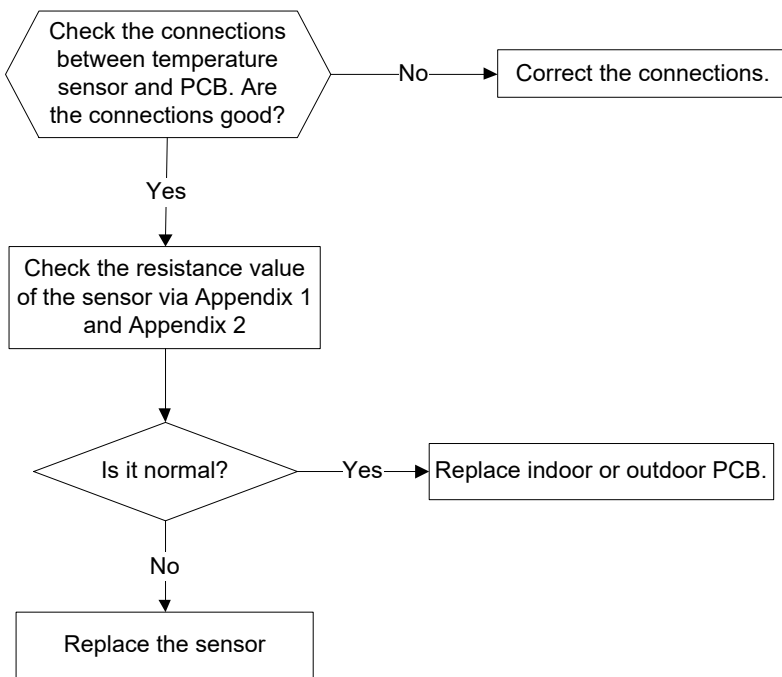

8.4.2.5 E5 (Over-voltage or under-voltage protection) diagnosis and solution.

Error Code	E5
Malfunction decision conditions	An abnormal voltage rise or drop is detected by checking the specified voltage detection circuit.
Supposed causes	<ul style="list-style-type: none"> ● Power supply problems. ● System leakage or block ● PCB faulty

Trouble shooting:

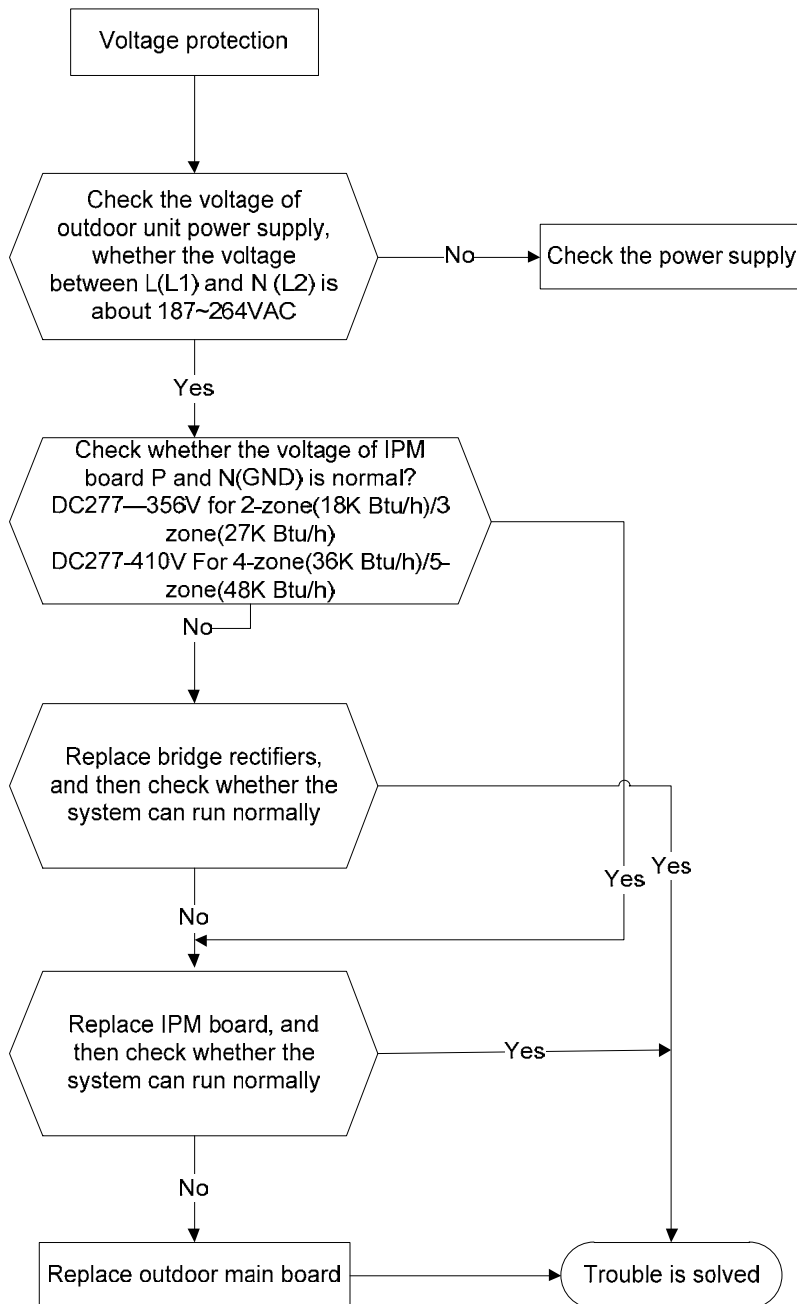

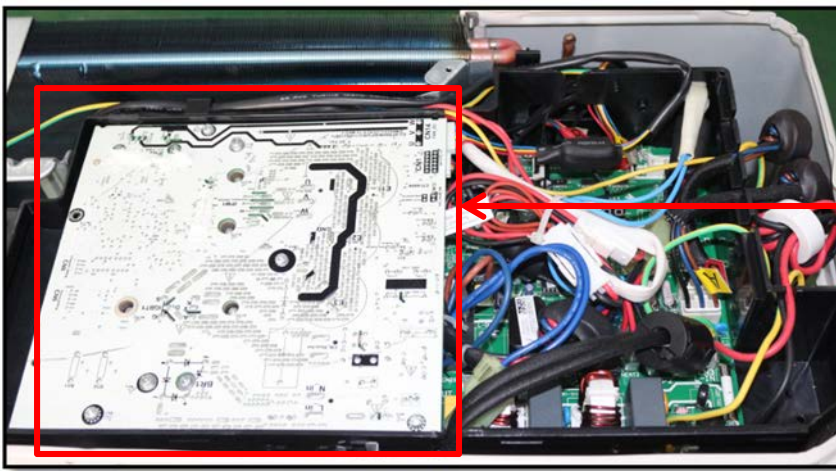

IPM board (for 2-zone /3-zone)

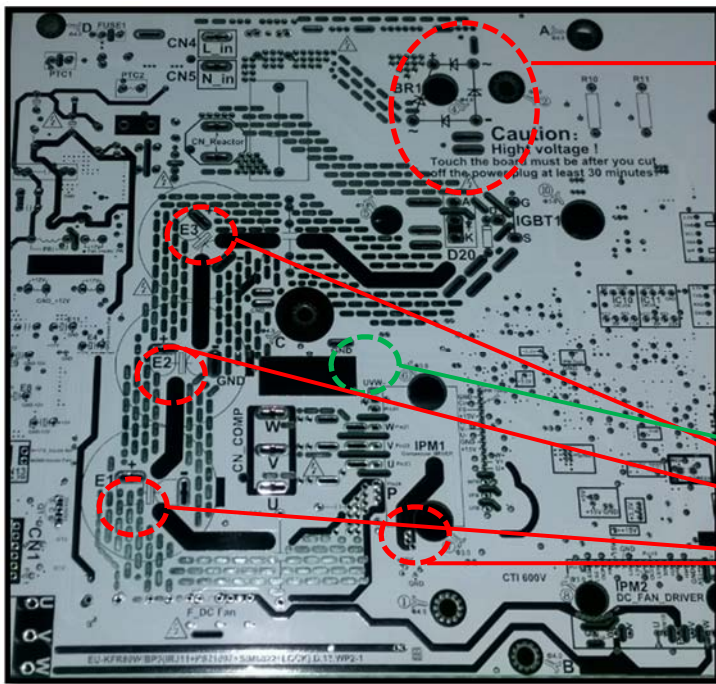

Bridge rectifier (for 2-zone/3-zone)

Remark:
Measure the DC voltage between + and - port. The normal value should be 190V~250V.

P(or E1/E2/E3)-N(GND) (for 2-zone/3-zone)

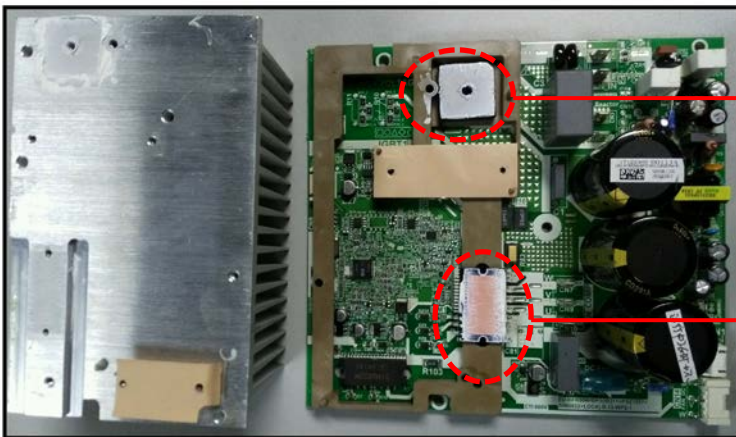

Bridge rectifier (for 2-zone/3-zone)

IPM Module (for 2-zone/3-zone)

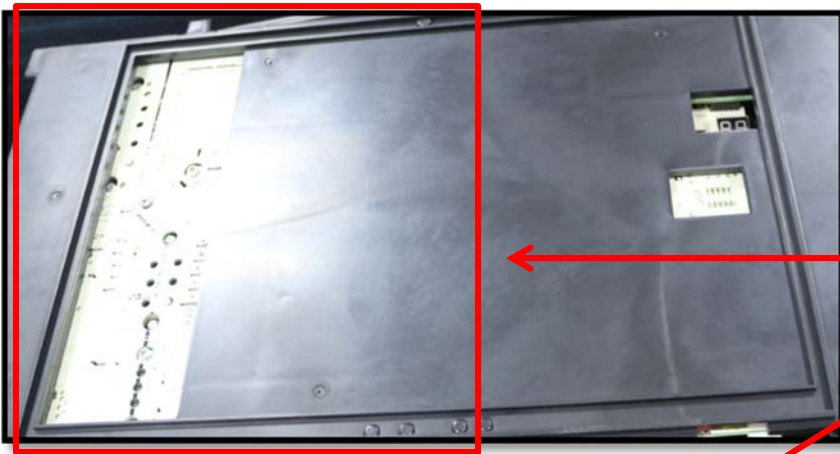

IPM board
(for 4-zone)

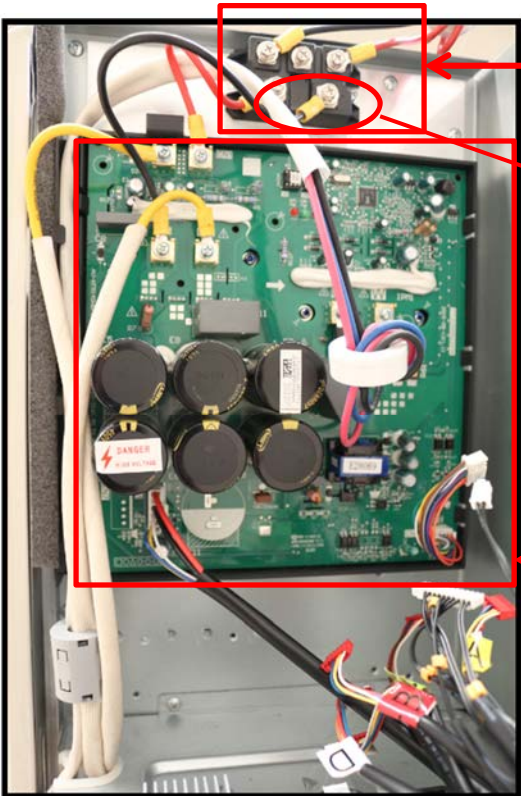
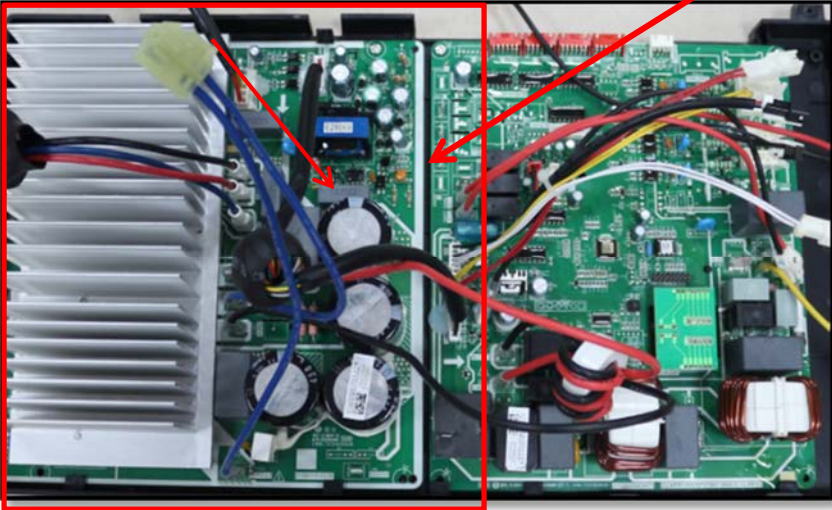

Bridge rectifier
(for 5-zone)

Remark:
Measure the DC voltage
between + and - port. The
normal value should be
190V~250V.

IPM board
(for 5-zone)

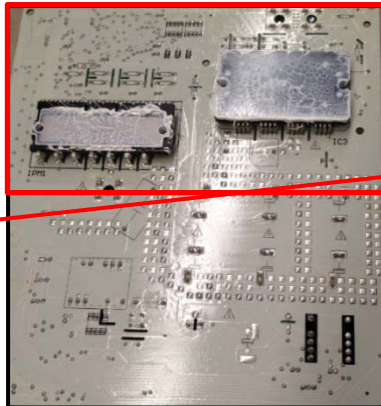

IPM Module
(for 5-zone)

8.4.2.6 E6 (PFC module protection) error diagnosis and solution.

Error Code	E6
Malfunction decision conditions	When the voltage signal that PFC sends to main control board is abnormal, the display LED will show “E6” and AC will turn off.
Supposed causes	<ul style="list-style-type: none"> ● Wiring mistake ● Outdoor PCB faulty ● Inductance of PFC module faulty ● PFC module malfunction

Trouble shooting:

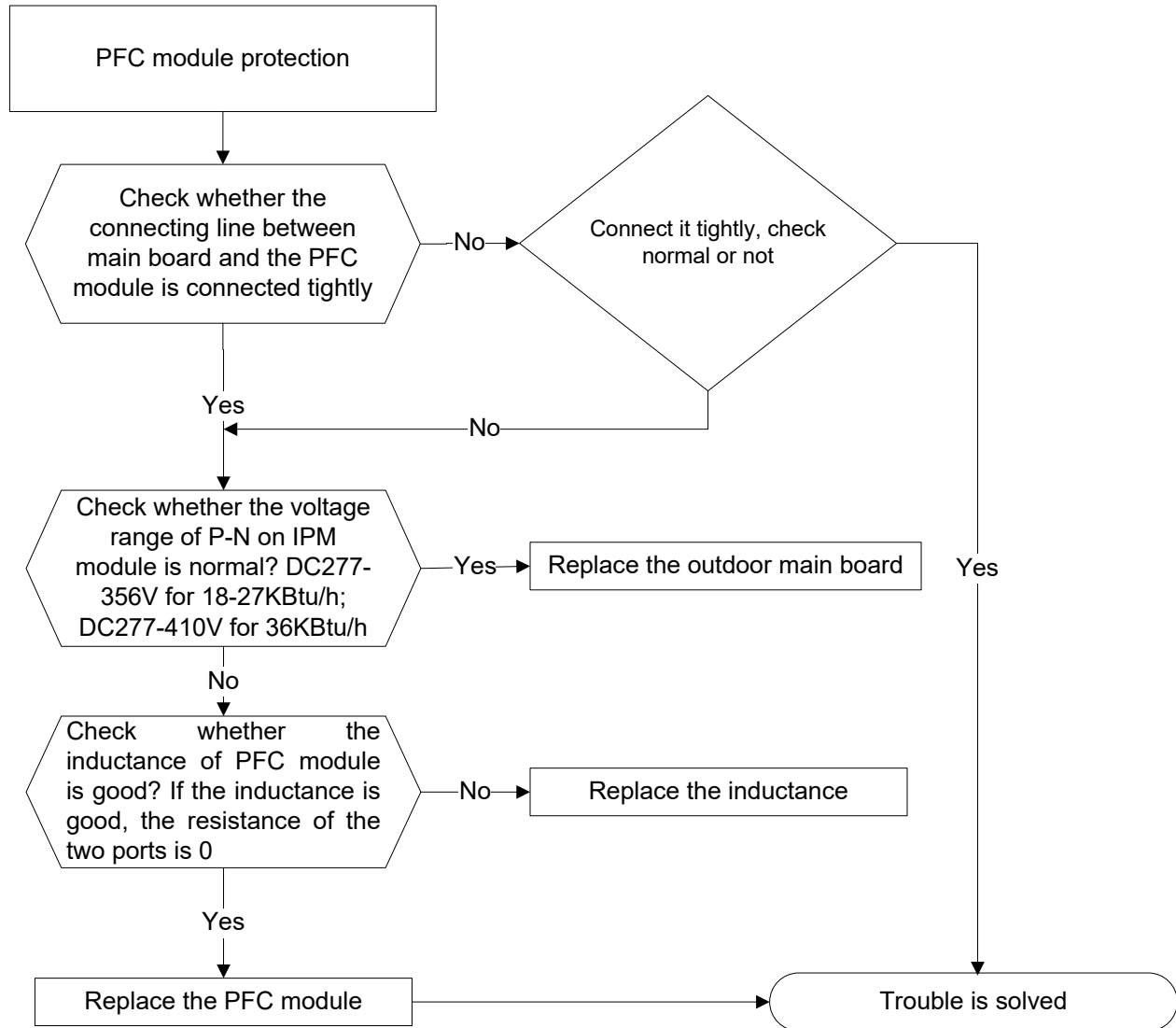

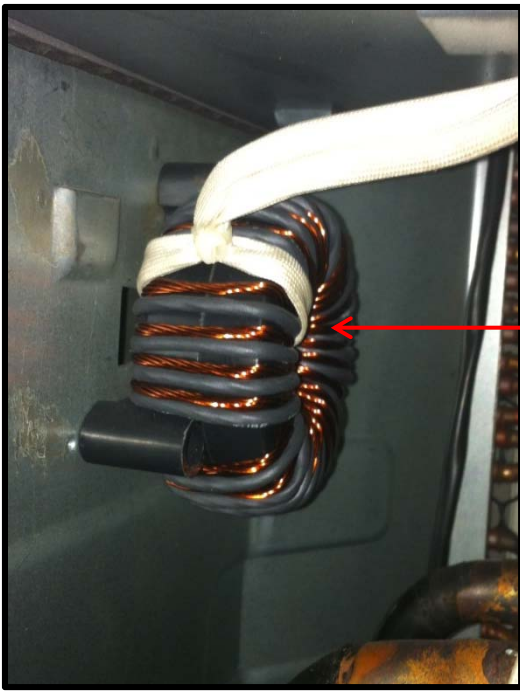

Inductance

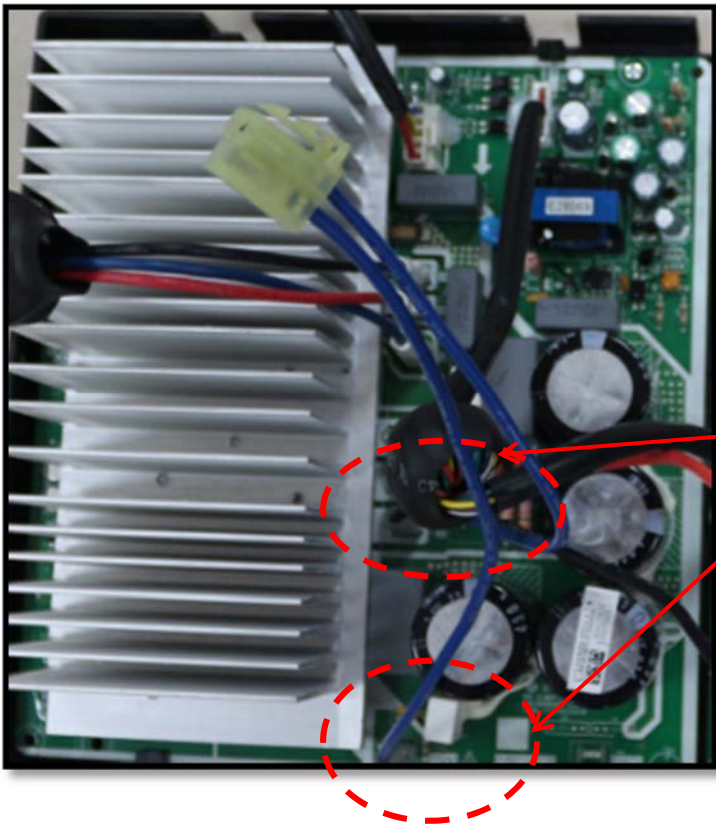

Two ports of the inductance

8.4.2.7 E8 (Outdoor fan speed has been out of control) diagnosis and solution

Error Code	E8
Malfunction decision conditions	When outdoor fan speed keeps too low (300RPM) or too high(2400RPM) for certain time, the unit will stop and the LED will display the failure.
Supposed causes	<ul style="list-style-type: none"> ● Wiring mistake ● Fan ass'y faulty ● Fan motor faulty ● PCB faulty

Trouble shooting:

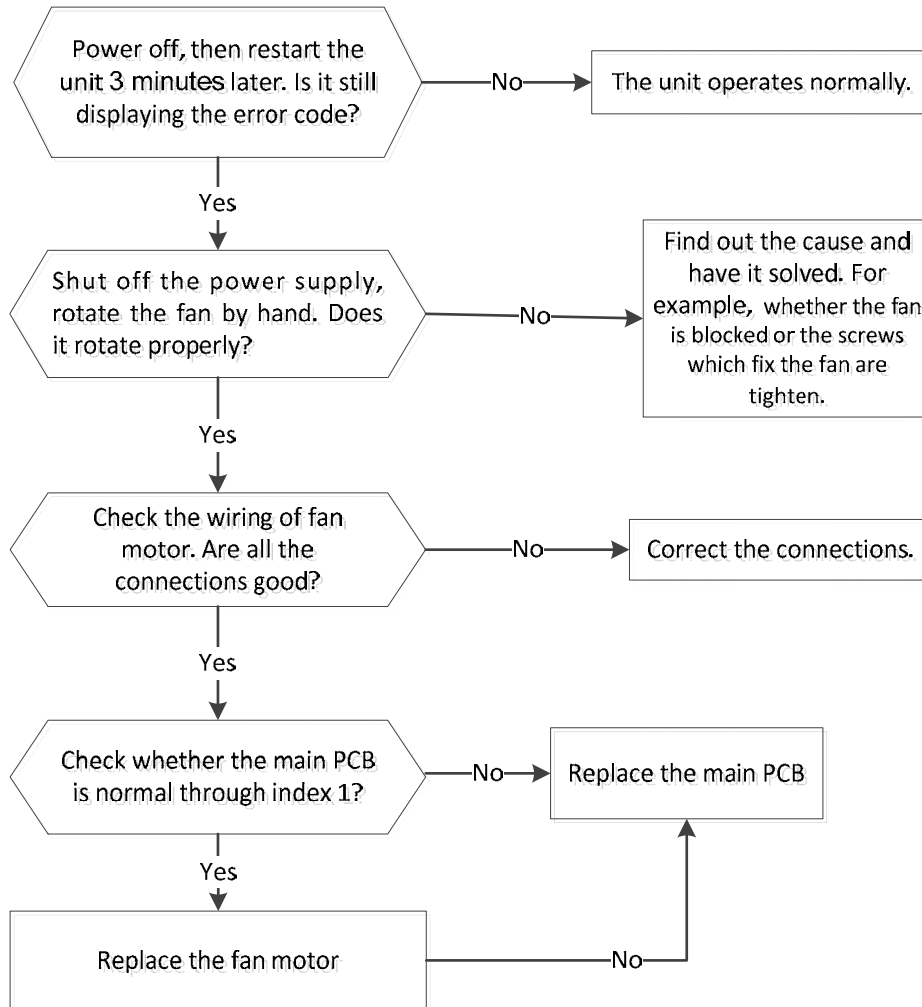

Index 1:

➤ **1. DC fan motor (control chip is inside fan motor)**

Power on and when the unit is in standby, measure the voltage of pin1-pin3, pin4-pin3 in fan motor connector. If the value of the voltage is not in the range showing in below table, the PCB must have problems and need to be replaced.

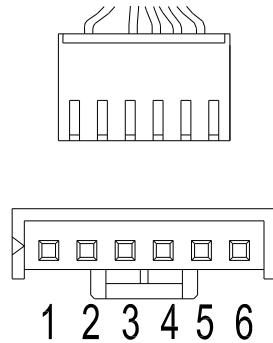

DC motor voltage input and output

NO.	Color	Signal	Voltage
1	Red	Vs/Vm	200~380V
2	---	---	---
3	Black	GND	0V
4	White	Vcc	13.5~16.5V
5	Yellow	Vsp	0~6.5V
6	Blue	FG	13.5~16.5V

Vs

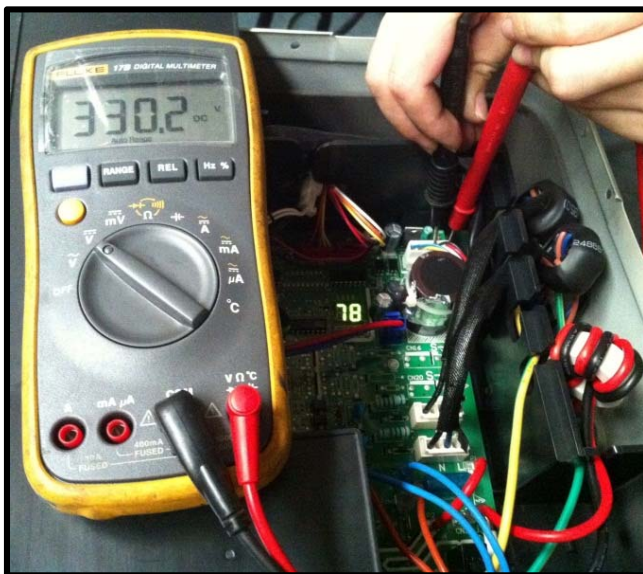

Vcc

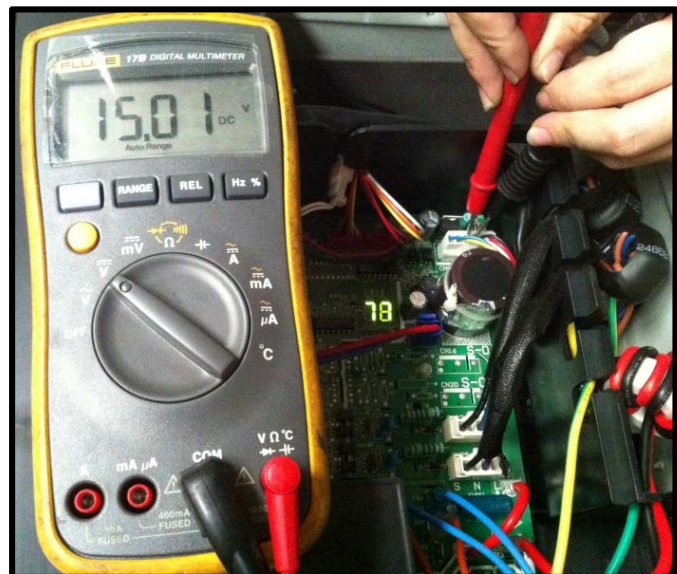

Vsp

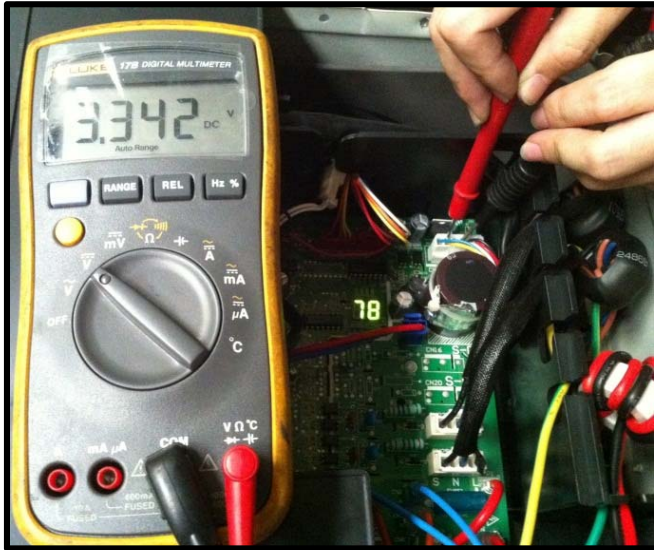

FG

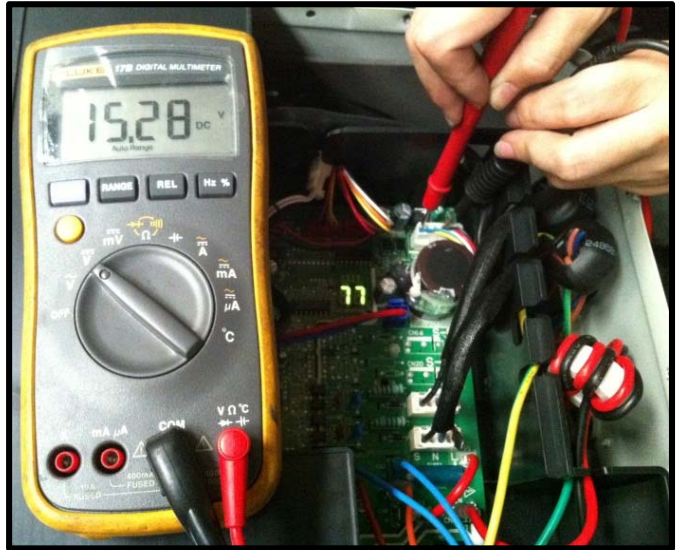

8.4.2.8 P0 (Compressor top high temperature protection (OLP)) diagnosis and solution.

Error Code	P0
Malfunction decision conditions	If the sampling voltage is not 5V, the LED will display the failure.
Supposed causes	<ul style="list-style-type: none"> ● Wiring mistake ● Over load protector faulty ● System block ● Outdoor PCB faulty

Trouble shooting:

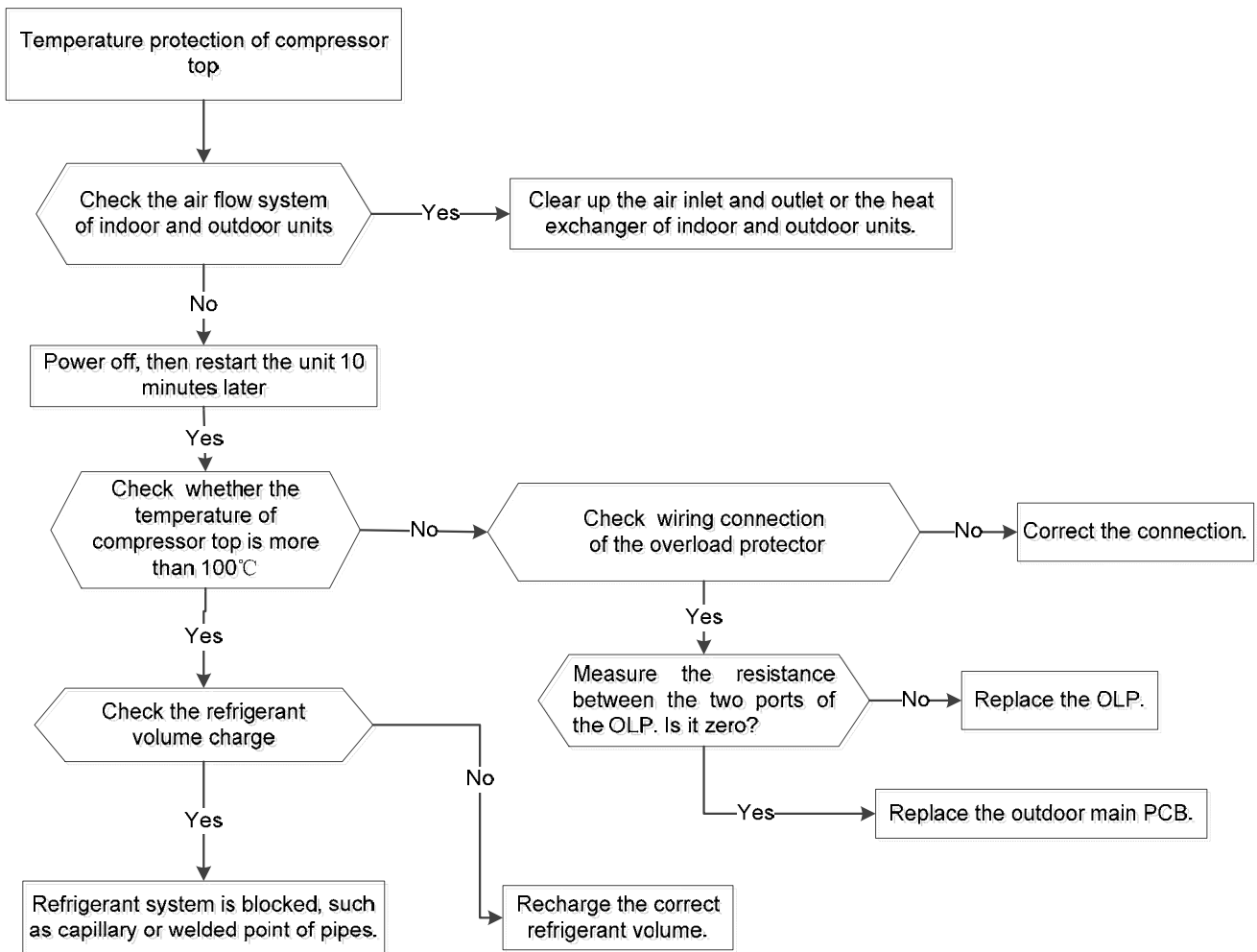

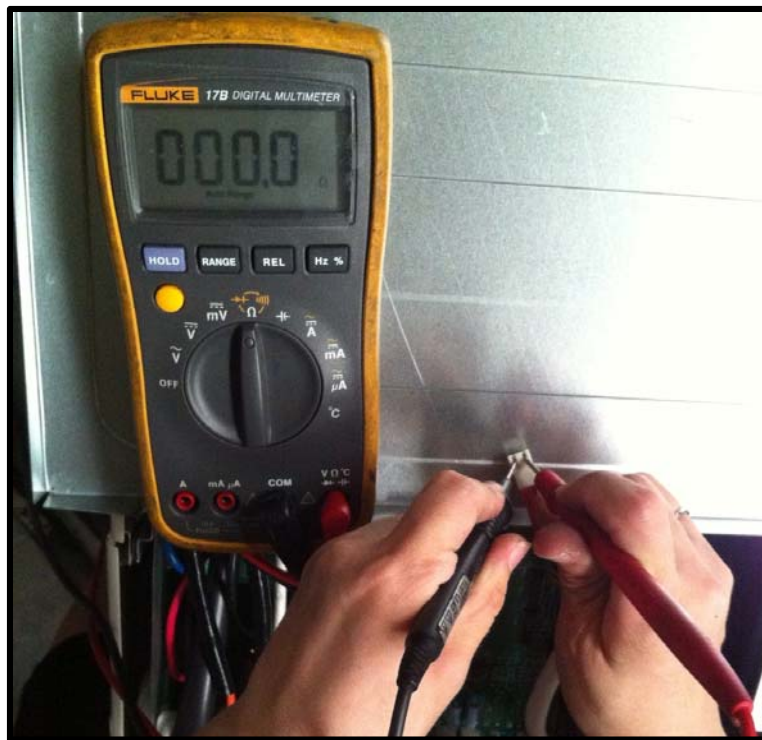
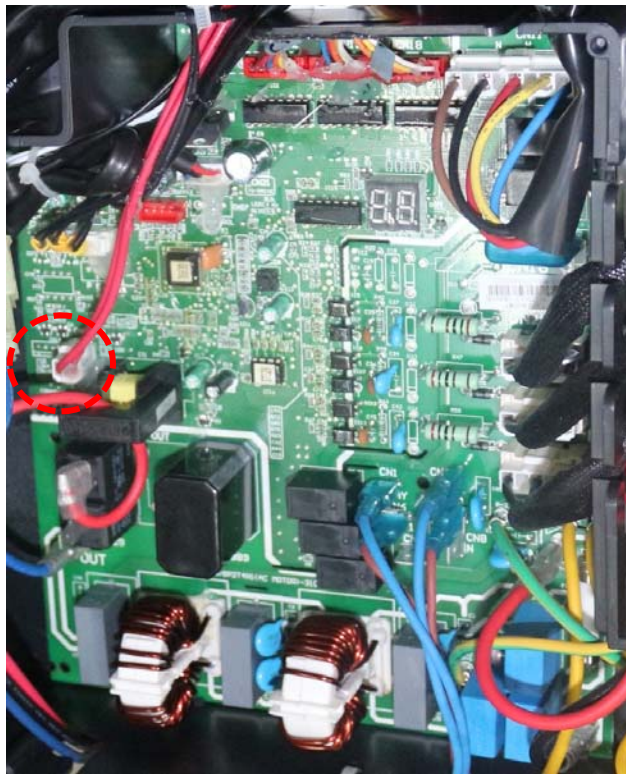

8.4.2.9 P1 (High pressure protection) diagnosis and solution.

Error Code	P1
Malfunction decision conditions	If the sampling voltage is not 5V, the LED will display the failure.
Supposed causes	<ul style="list-style-type: none"> ● Wiring mistake ● Over load protector faulty ● System block ● Outdoor PCB faulty

Trouble shooting:

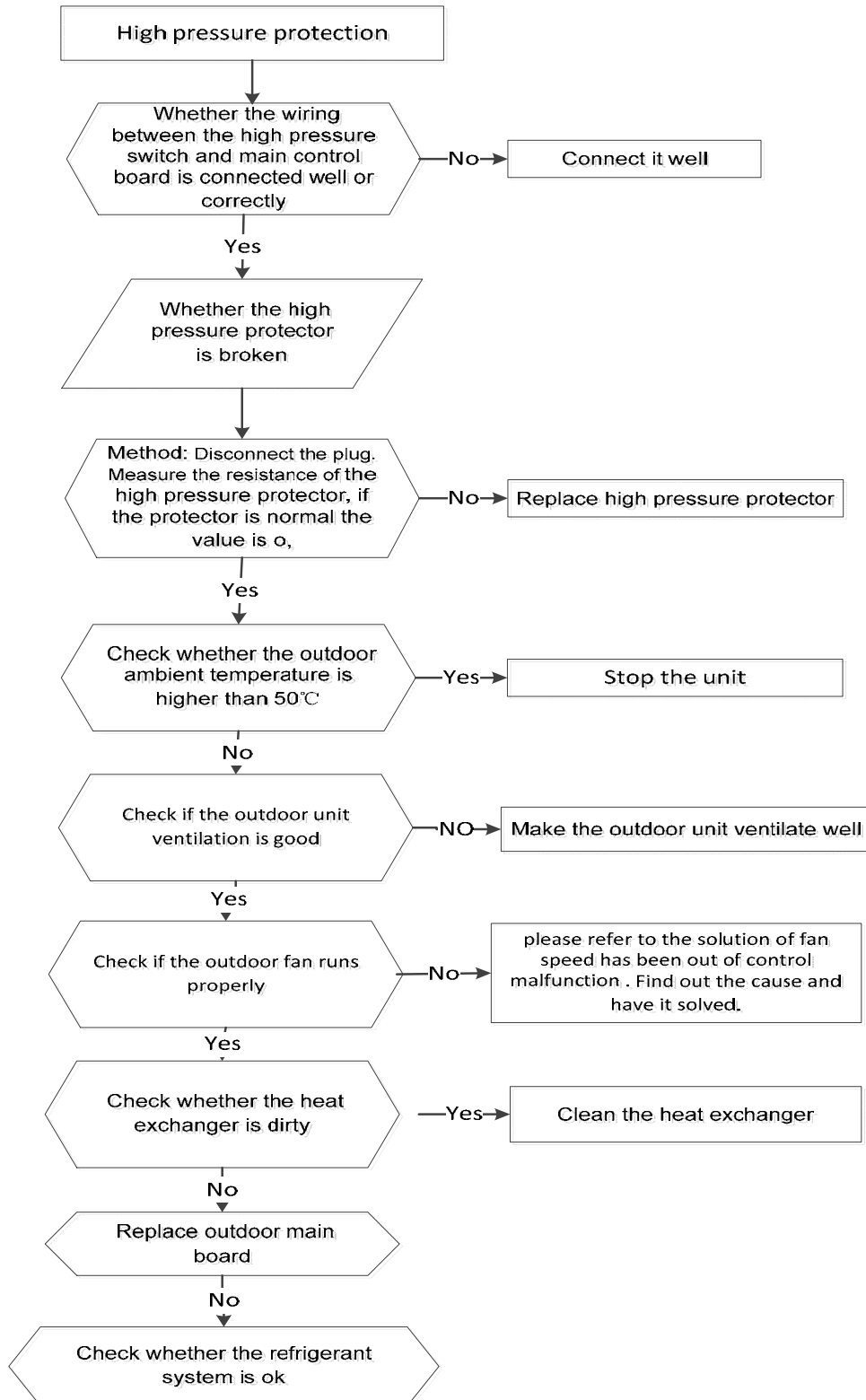

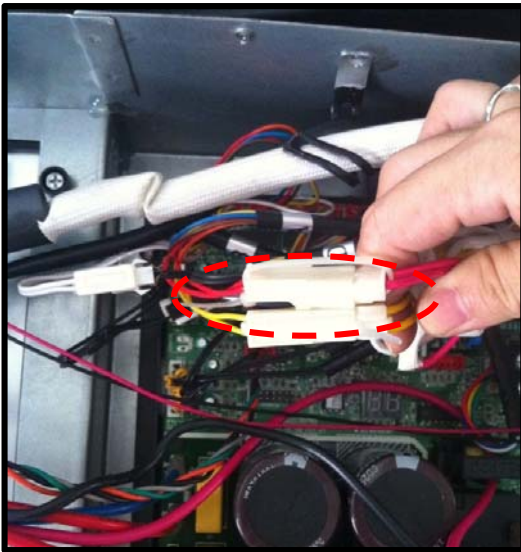
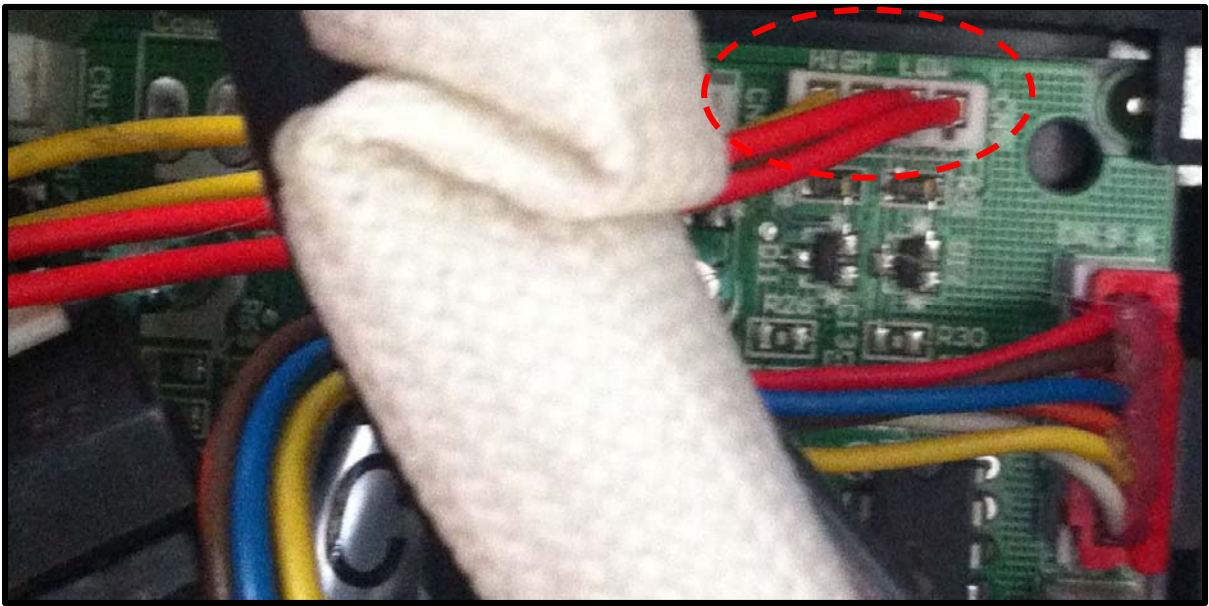

8.4.2.10 P2 (Low pressure protection) diagnosis and solution.

Error Code	P2
Malfunction decision conditions	If the sampling voltage is not 5V, the LED will display the failure.
Supposed causes	<ul style="list-style-type: none"> ● Wiring mistake ● Over load protector faulty ● System block ● Outdoor PCB faulty

Trouble shooting:

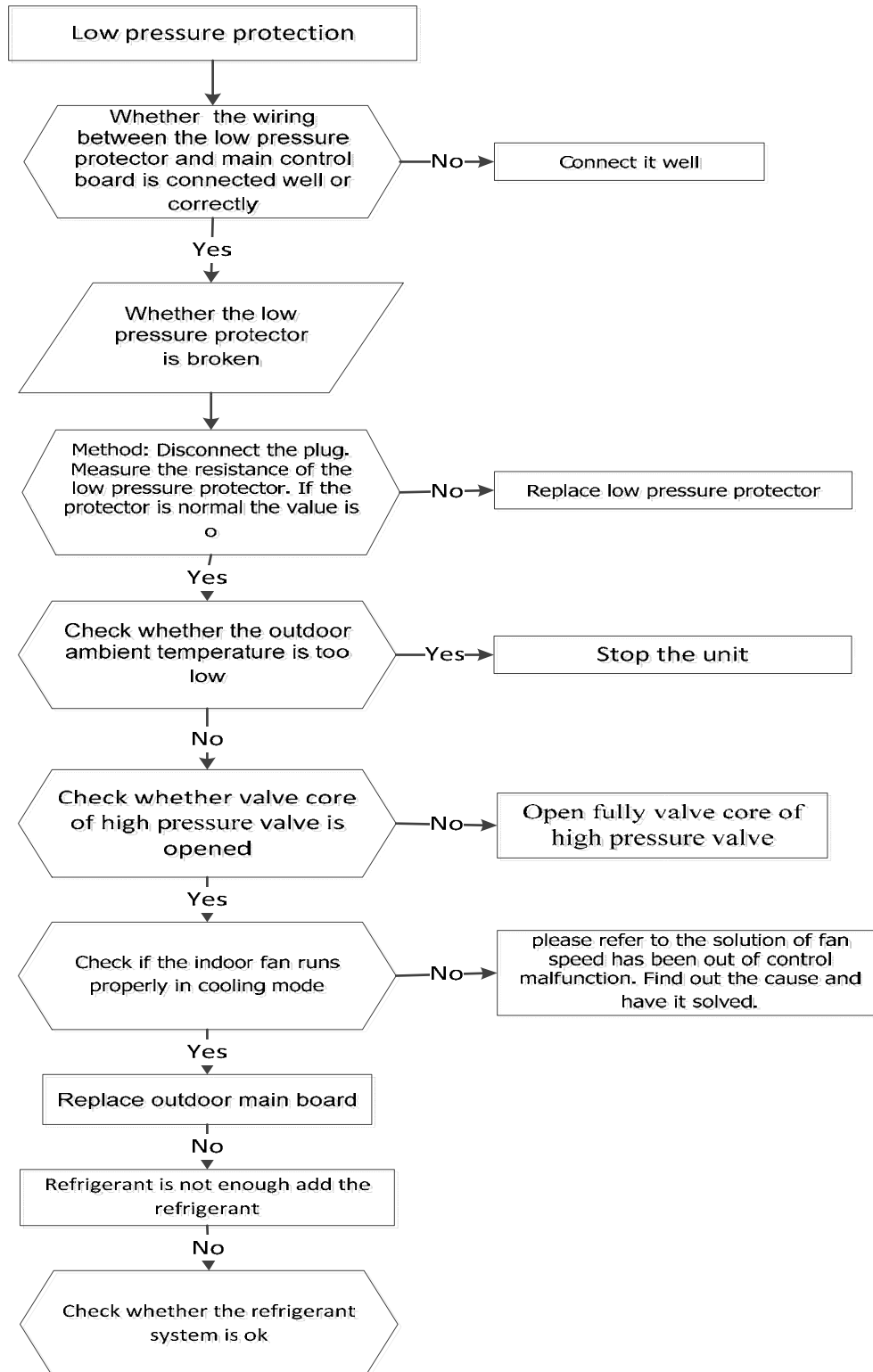

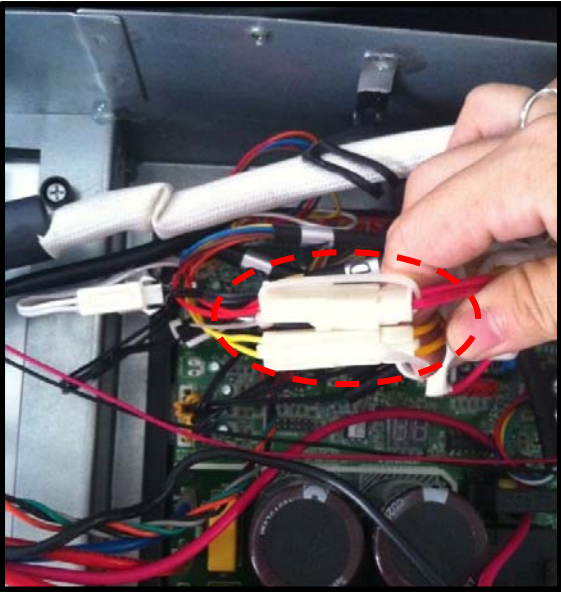
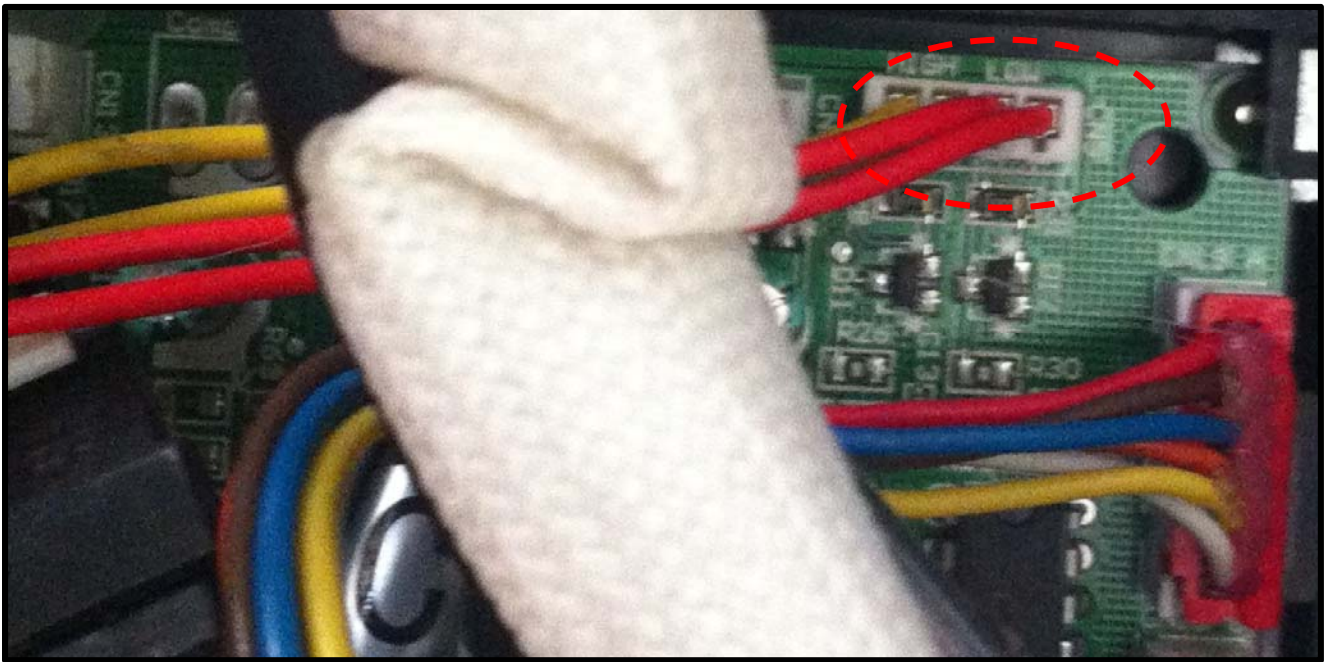

8.4.2.11 P3 (Current overload protection) diagnosis and solution.

Error Code	P3
Malfunction decision conditions	If the outdoor current exceeds the current limit value, the LED will display the failure.
Supposed causes	<ul style="list-style-type: none"> ● Wiring mistake ● Over load protector faulty ● System block ● Outdoor PCB faulty

Trouble shooting:

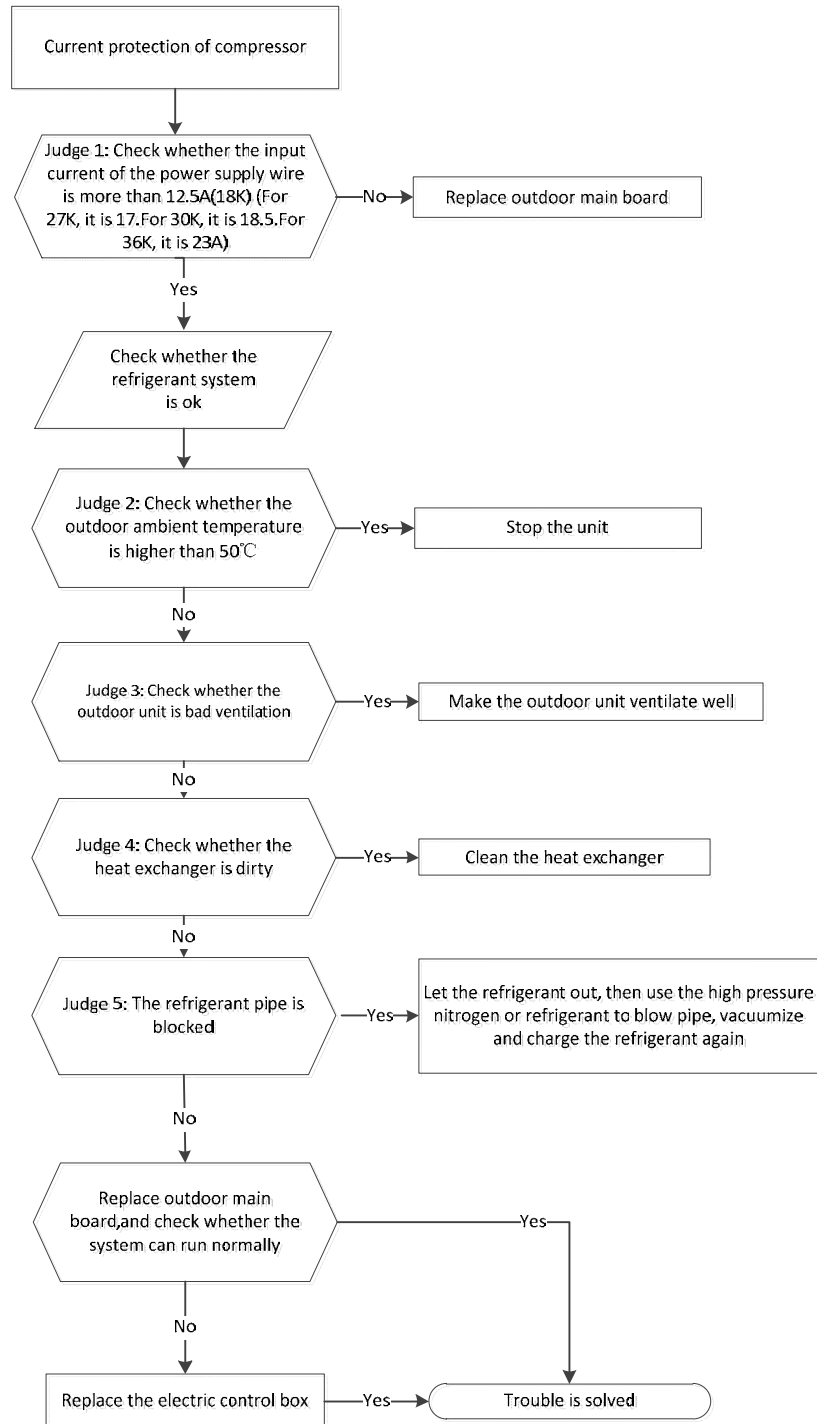



8.4.2.12 P4 (Temperature protection of compressor discharge) diagnosis and solution.

Error Code	P4
Malfunction decision conditions	When the compressor discharge temperature(T5) is more than 115°C for 10 seconds, the compressor will stop and restart till T5 is less than 90°C.
Supposed causes	<ul style="list-style-type: none"> ● Refrigerant leakage ● Wiring mistake ● The discharge temperature sensor faulty ● Outdoor PCB faulty

Trouble shooting:

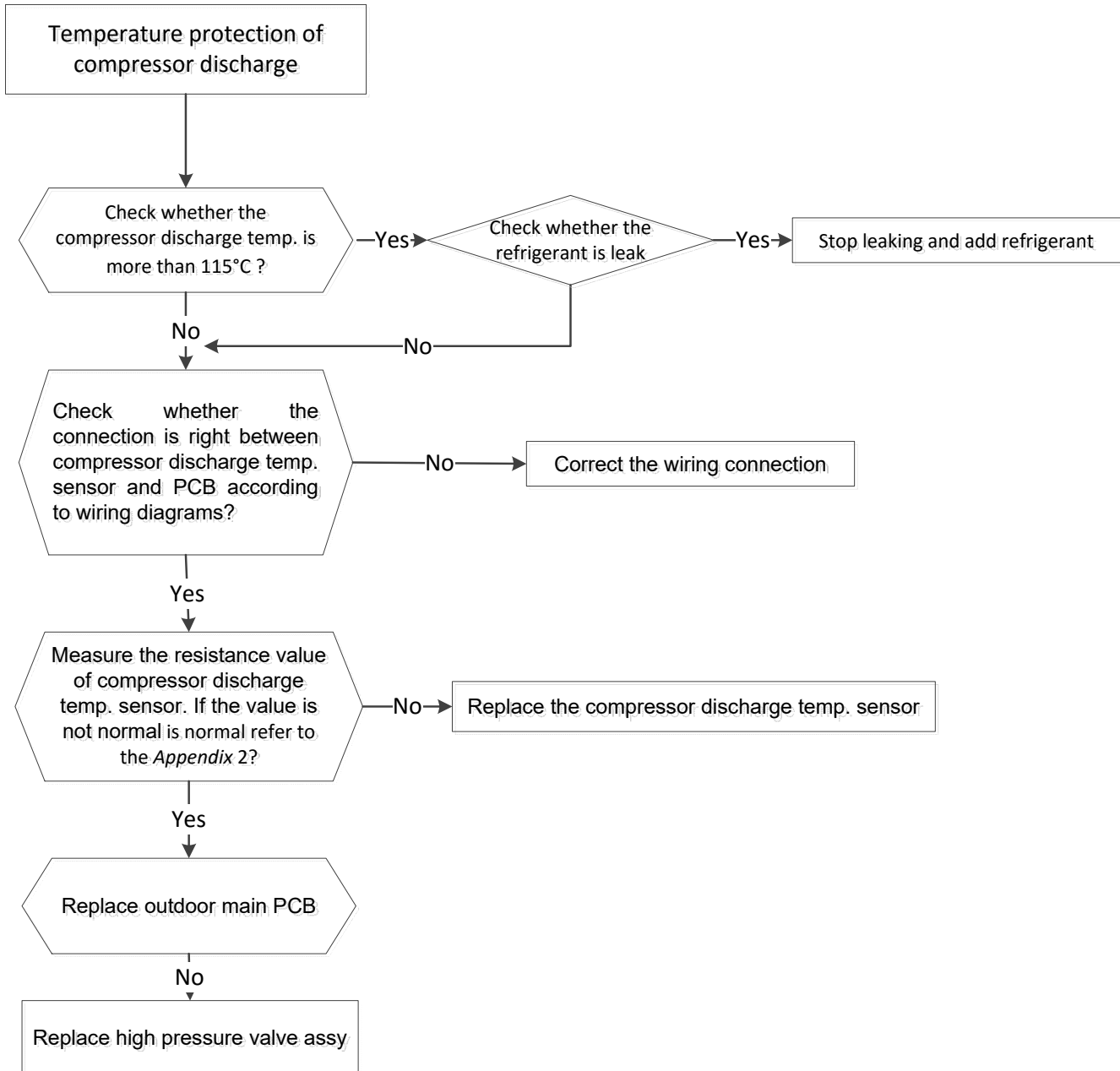

8.4.2.13 P5 (High temperature protection of condenser) diagnosis and solution.

Error Code	P5
Malfunction decision conditions	When outdoor pipe temperature is more than 65°C, the unit will stop, and unit runs again when outdoor pipe temperature is less than 52°C
Supposed causes	<ul style="list-style-type: none"> ● The condenser temperature sensor faulty ● Heat exchanger dirty ● System block

Trouble shooting:

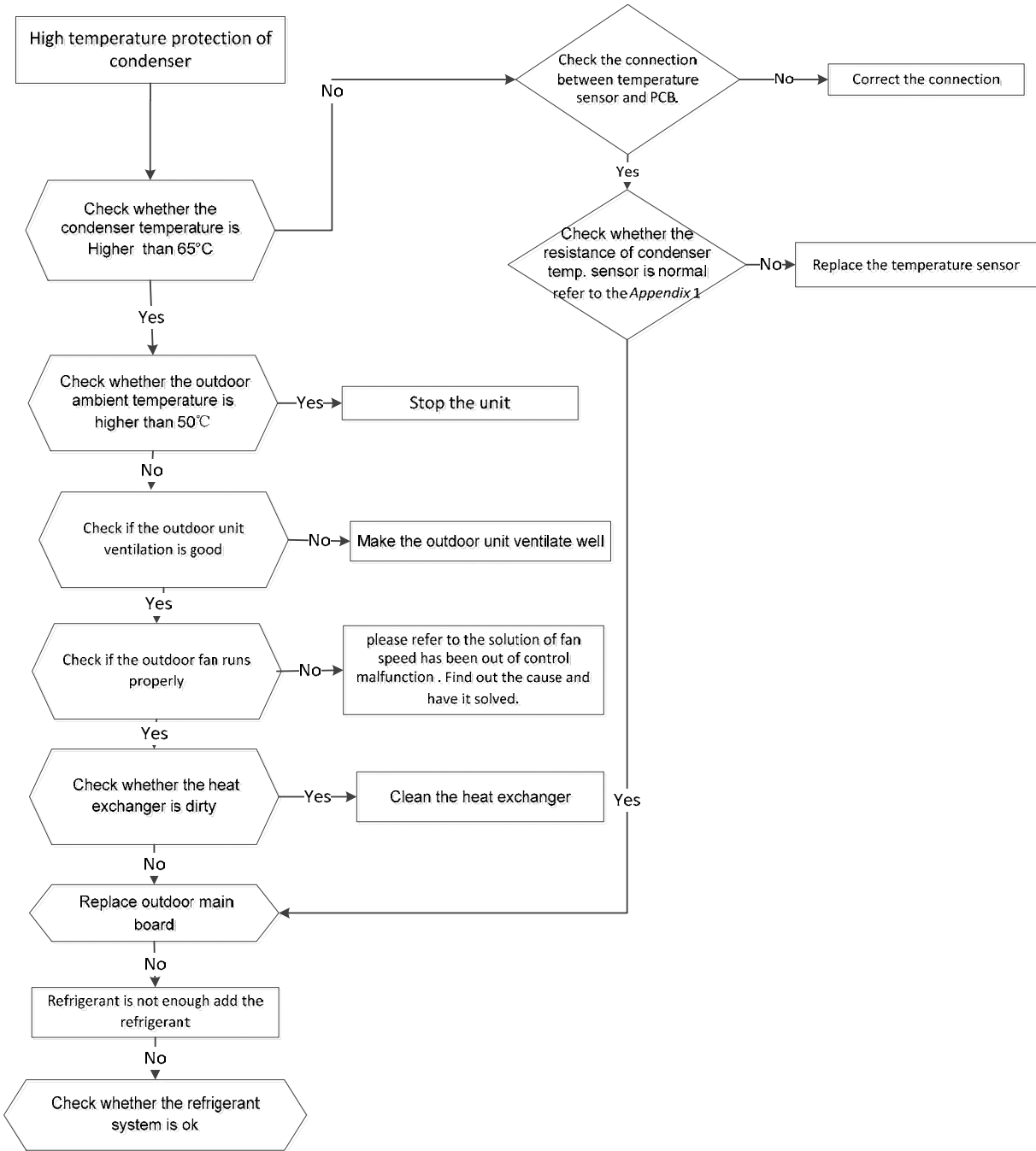

8.4.2.14 P6 (Inverter module (IPM) malfunction) diagnosis and solution.

Error Code	P6
Malfunction decision conditions	When the voltage signal that IPM send to compressor drive chip is abnormal, the display LED will show “P6” and AC will turn off.
Supposed causes	<ul style="list-style-type: none"> ● Wiring mistake ● IPM malfunction ● Outdoor fan ass’y faulty ● Compressor malfunction ● Outdoor PCB faulty

Trouble shooting:

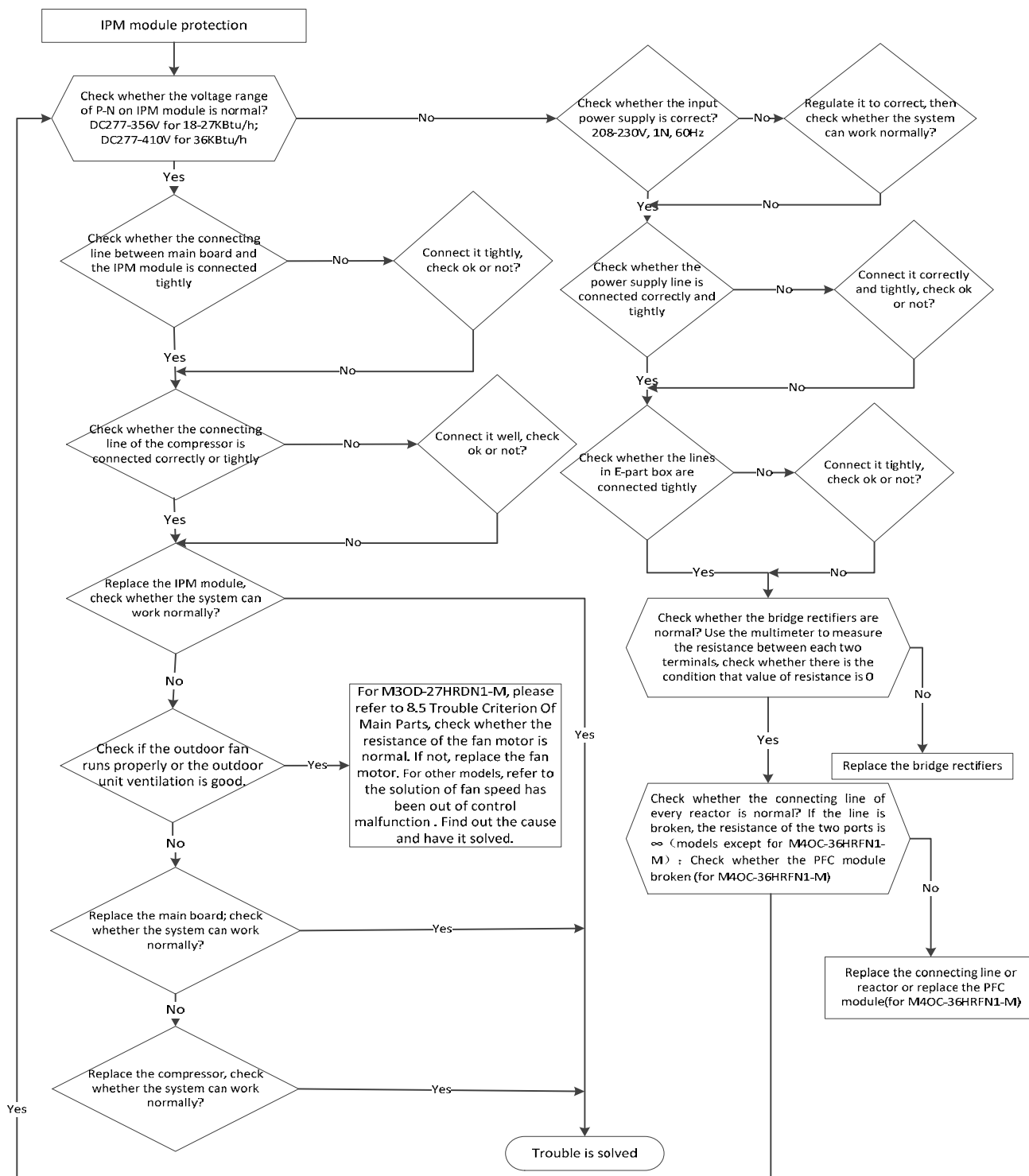

8.4.2.15 The cooling operation or heating operation does not operate.

Supposed causes

- 4-way valve faulty

Check of 4-way valve, please refer to part 5 in 9.5 Trouble Criterion of Main Parts.

8.4.2.16 When cooling, heat exchanger of non-operating indoor unit frosts.

When heating, non-operating indoor unit get warm.

Supposed causes

- EXV faulty
- Wire and tubing connected in reverse.

Check of EXV, please refer to part 6 in 9.5 Trouble Criterion of Main Parts.

8.5 Trouble Criterion of Main Parts.

Spec.

Outdoor unit				
Model	YN020GLFI22M2D	YN030GLFI22M3D	YN040GLFI22M4D	YN050GLFI22M5D
Compressor	ATM150D23UFZ	ATF235D22UMT	ATF310D43UMT	ATQ360D1UMU
Outdoor fan motor	ZKFN-50-8-2	ZKFN-120-8-2	ZKFN-120-8-2	ZKFN-85-8-22

Temperature sensor checking

Disconnect the temperature sensor from PCB, measure the resistance value with a tester.

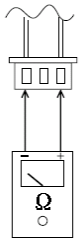

Tester

Temperature Sensors.

Room temp.(T1) sensor,

Indoor coil temp.(T2) sensor,

Outdoor coil temp.(T3) sensor,

Outdoor ambient temp.(T4) sensor,

Compressor discharge temp.(T5) sensor.

Measure the resistance value of each winding by using the multi-meter.

Appendix 1 Temperature Sensor Resistance Value Table (°C--K)

°C	K Ohm	°C	K Ohm	°C	K Ohm	°C	K Ohm
-20	115.266	20	12.6431	60	2.35774	100	0.62973
-19	108.146	21	12.0561	61	2.27249	101	0.61148
-18	101.517	22	11.5000	62	2.19073	102	0.59386
-17	96.3423	23	10.9731	63	2.11241	103	0.57683
-16	89.5865	24	10.4736	64	2.03732	104	0.56038
-15	84.2190	25	10.0000	65	1.96532	105	0.54448
-14	79.3110	26	9.55074	66	1.89627	106	0.52912
-13	74.5360	27	9.12445	67	1.83003	107	0.51426
-12	70.1698	28	8.71983	68	1.76647	108	0.49989
-11	66.0898	29	8.33566	69	1.70547	109	0.48600
-10	62.2756	30	7.97078	70	1.64691	110	0.47256
-9	58.7079	31	7.62411	71	1.59068	111	0.45957
-8	56.3694	32	7.29464	72	1.53668	112	0.44699
-7	52.2438	33	6.98142	73	1.48481	113	0.43482
-6	49.3161	34	6.68355	74	1.43498	114	0.42304
-5	46.5725	35	6.40021	75	1.38703	115	0.41164
-4	44.0000	36	6.13059	76	1.34105	116	0.40060
-3	41.5878	37	5.87359	77	1.29078	117	0.38991
-2	39.8239	38	5.62961	78	1.25423	118	0.37956
-1	37.1988	39	5.39689	79	1.21330	119	0.36954
0	35.2024	40	5.17519	80	1.17393	120	0.35982
1	33.3269	41	4.96392	81	1.13604	121	0.35042
2	31.5635	42	4.76253	82	1.09958	122	0.3413
3	29.9058	43	4.57050	83	1.06448	123	0.33246
4	28.3459	44	4.38736	84	1.03069	124	0.32390
5	26.8778	45	4.21263	85	0.99815	125	0.31559
6	25.4954	46	4.04589	86	0.96681	126	0.30754
7	24.1932	47	3.88673	87	0.93662	127	0.29974
8	22.5662	48	3.73476	88	0.90753	128	0.29216
9	21.8094	49	3.58962	89	0.87950	129	0.28482
10	20.7184	50	3.45097	90	0.85248	130	0.27770
11	19.6891	51	3.31847	91	0.82643	131	0.27078
12	18.7177	52	3.19183	92	0.80132	132	0.26408
13	17.8005	53	3.07075	93	0.77709	133	0.25757
14	16.9341	54	2.95896	94	0.75373	134	0.25125
15	16.1156	55	2.84421	95	0.73119	135	0.24512
16	15.3418	56	2.73823	96	0.70944	136	0.23916
17	14.6181	57	2.63682	97	0.68844	137	0.23338
18	13.9180	58	2.53973	98	0.66818	138	0.22776
19	13.2631	59	2.44677	99	0.64862	139	0.22231

Appendix 2

		Unit: °C---K		Discharge temp. sensor table			
-20	542.7	20	68.66	60	13.59	100	3.702
-19	511.9	21	65.62	61	13.11	101	3.595
-18	483	22	62.73	62	12.65	102	3.492
-17	455.9	23	59.98	63	12.21	103	3.392
-16	430.5	24	57.37	64	11.79	104	3.296
-15	406.7	25	54.89	65	11.38	105	3.203
-14	384.3	26	52.53	66	10.99	106	3.113
-13	363.3	27	50.28	67	10.61	107	3.025
-12	343.6	28	48.14	68	10.25	108	2.941
-11	325.1	29	46.11	69	9.902	109	2.86
-10	307.7	30	44.17	70	9.569	110	2.781
-9	291.3	31	42.33	71	9.248	111	2.704
-8	275.9	32	40.57	72	8.94	112	2.63
-7	261.4	33	38.89	73	8.643	113	2.559
-6	247.8	34	37.3	74	8.358	114	2.489
-5	234.9	35	35.78	75	8.084	115	2.422
-4	222.8	36	34.32	76	7.82	116	2.357
-3	211.4	37	32.94	77	7.566	117	2.294
-2	200.7	38	31.62	78	7.321	118	2.233
-1	190.5	39	30.36	79	7.086	119	2.174
0	180.9	40	29.15	80	6.859	120	2.117
1	171.9	41	28	81	6.641	121	2.061
2	163.3	42	26.9	82	6.43	122	2.007
3	155.2	43	25.86	83	6.228	123	1.955
4	147.6	44	24.85	84	6.033	124	1.905
5	140.4	45	23.89	85	5.844	125	1.856
6	133.5	46	22.89	86	5.663	126	1.808
7	127.1	47	22.1	87	5.488	127	1.762
8	121	48	21.26	88	5.32	128	1.717
9	115.2	49	20.46	89	5.157	129	1.674
10	109.8	50	19.69	90	5	130	1.632
11	104.6	51	18.96	91	4.849		
12	99.69	52	18.26	92	4.703		
13	95.05	53	17.58	93	4.562		
14	90.66	54	16.94	94	4.426		
15	86.49	55	16.32	95	4.294	B(25/50)=3950K	
16	82.54	56	15.73	96	4.167		
17	78.79	57	15.16	97	4.045	R(90°C)=5KΩ±3%	
18	75.24	58	14.62	98	3.927		
19	71.86	59	14.09	99	3.812		

Appendix 3:

°C	10	11	12	13	14	15	16	17	18	19	20	21	22
°F	48	50	52	54	56	58	60	62	64	66	68	70	72
°C	23	24	25	26	27	28	29	30	31	32	33	34	35
°F	74	76	78	80	82	84	86	88	90	92	94	96	98

2. Compressor check

Measure the resistance value of each winding by using the tester.

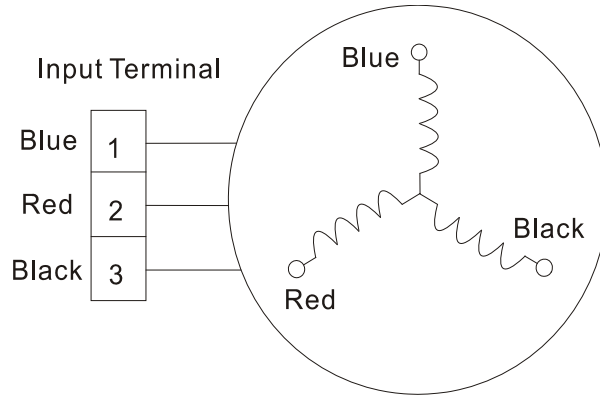

Position	Resistance Value					
	ATM150D23UFZ	ATF235D22UMT	ATF250D22UMT	ATF310D43UMT	ATQ360D1UMU	ATQ420D1UMU
Blue - Red	1.72 Ω	0.75 Ω	0.75 Ω	0.65 Ω	0.37 Ω	0.38Ω



3. IPM continuity check

Turn off the power, let the large capacity electrolytic capacitors discharge completely, and dismount the IPM. Use a digital tester to measure the resistance between P and UVWN; UVW and N.

Digital tester		Normal resistance value	Digital tester		Normal resistance value
(+)Red	(-)Black		(+)Red	(-)Black	
P	N	∞ (Several M Ω)	U	N	∞ (Several M Ω)
	U		V		
	V		W		
	W		(+)Red		

4. AC Fan Motor.

Measure the resistance value of each winding by using the tester.

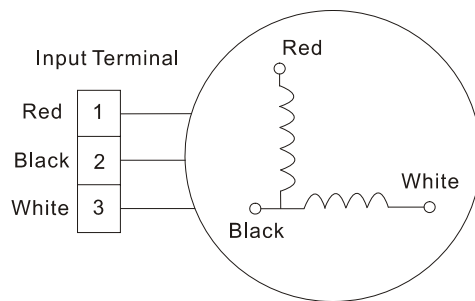

Position	Resistance Value			
	RPG20B		RPG28H	
Black - Red	381 Ω ±8% (20°C) (Brand: Weiling)	342 Ω ±8% (20°C) (Brand: Dayang)	183.6 Ω ±8% (20°C) (Brand: Weiling)	180 Ω ±8% (20°C) (Brand: Wolong)
White - Black	267 Ω ±8% (20°C) (Brand: Weiling)	253 Ω ±8% (20°C) (Brand: Dayang)	206 Ω ±8% (20°C) (Brand: Weiling)	190 Ω ±8% (20°C) (Brand: Wolong)

Measure the resistance value of each winding by using the tester.

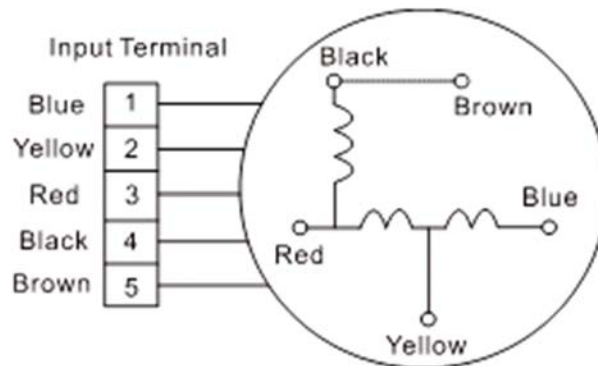

Position	Resistance Value						
	YDK70-6FB	YDK180-8GB	YSK27-4G	YSK68-4B	YDK45-6B	YSK25-6L	YDK53-6FB(B)
Black - Red	56Ω±8% (20℃)	24.5Ω±8% (20℃)	317Ω±8% (20℃)	145Ω±8% (20℃)	345Ω±8% (20℃)	627Ω±8% (20℃)	88.5Ω±8% (20℃)
Red - Yellow	76Ω±8% (20℃)	19Ω±8% (20℃)	252Ω±8% (20℃)	88Ω±8% (20℃)	150Ω±8% (20℃)	374.3Ω±8% (20℃)	138Ω±8% (20℃)
Yellow - Blue	76Ω±8% (20℃)	19Ω±8% (20℃)	252Ω±8% (20℃)	88Ω±8% (20℃)	150Ω±8% (20℃)	374.3Ω±8% (20℃)	138Ω±8% (20℃)

5.4-way valve

1. Power on, use a digital tester to measure the voltage, when the unit operates in cooling, it is 0V. When the unit operates in heating, it is about 230VAC.

If the value of the voltage is not in the range, the PCB must have problems and need to be replaced.

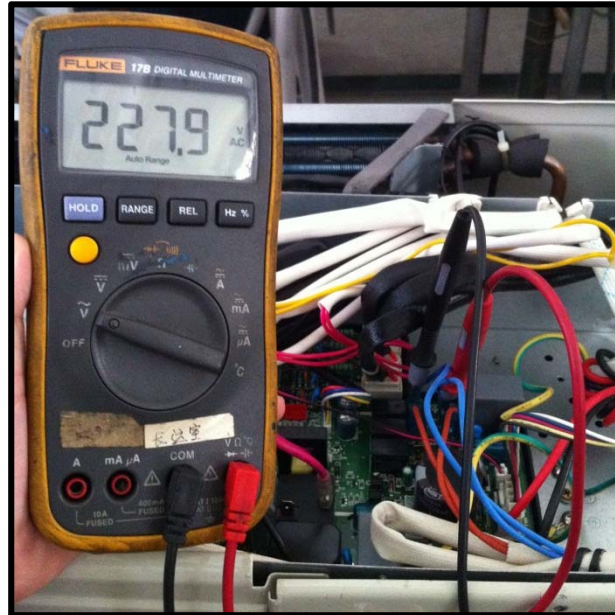

2 Turn off the power, use a digital tester to measure the resistance. The value should be 1.8~2.5 KΩ.

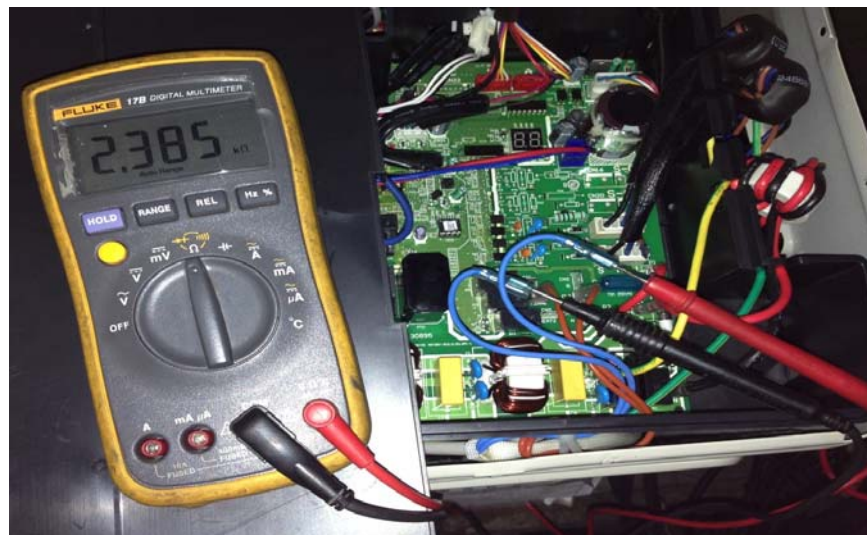

6.EXV check

Disconnect the connectors.

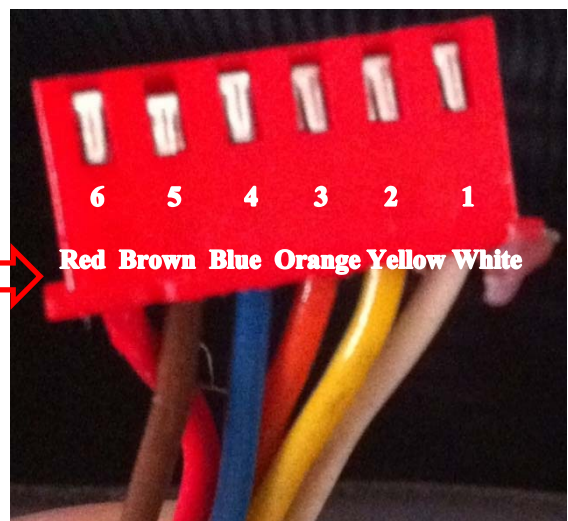
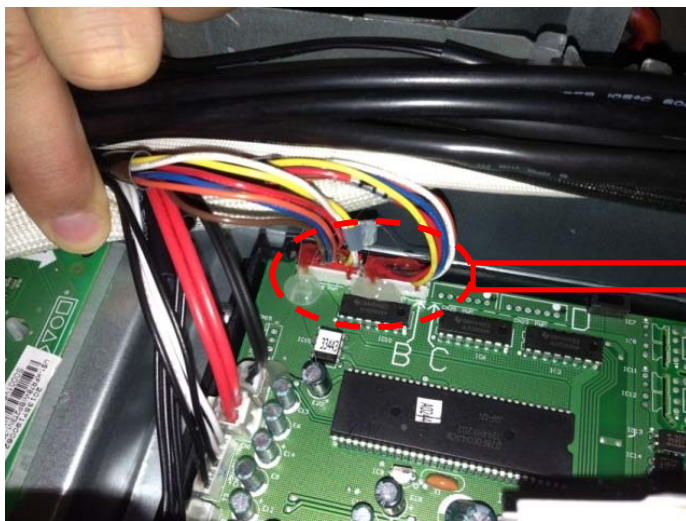
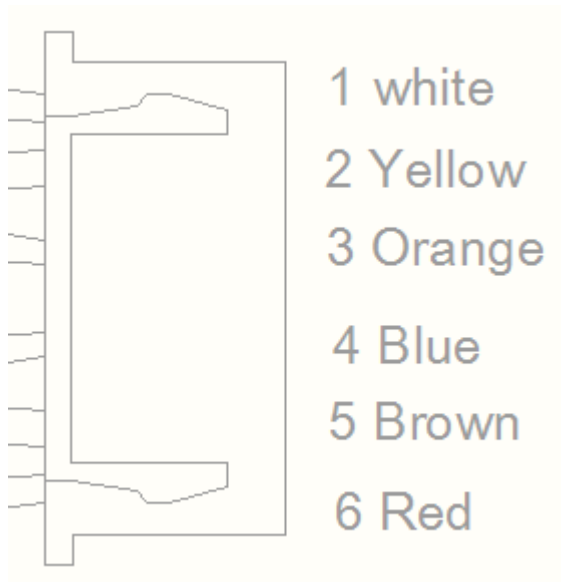

Resistance to EXV coil

Color of lead wire	Normal Value
Red- Blue	About 50Ω
Red - Yellow	
Brown-Orange	
Brown-White	

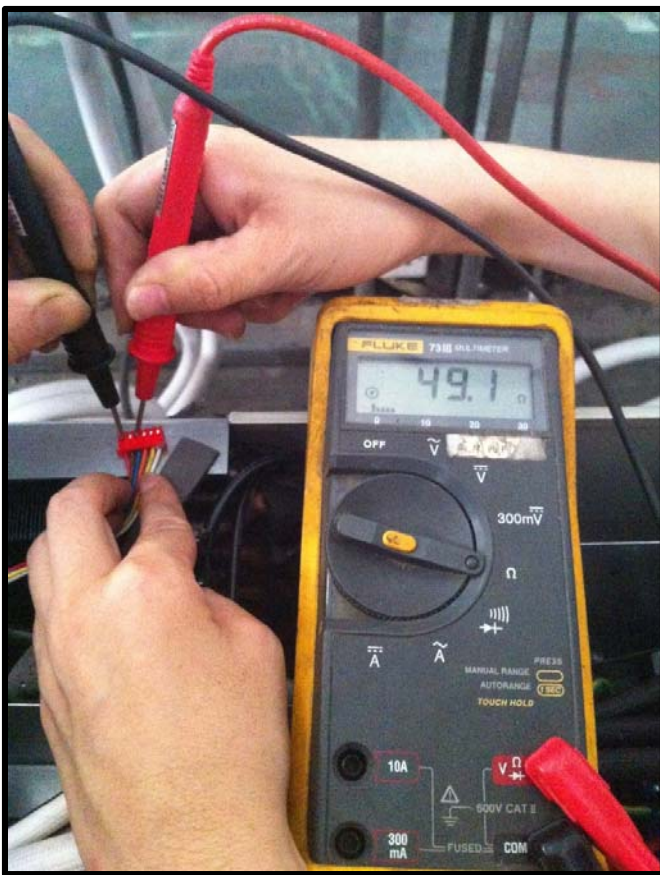

Red- Blue

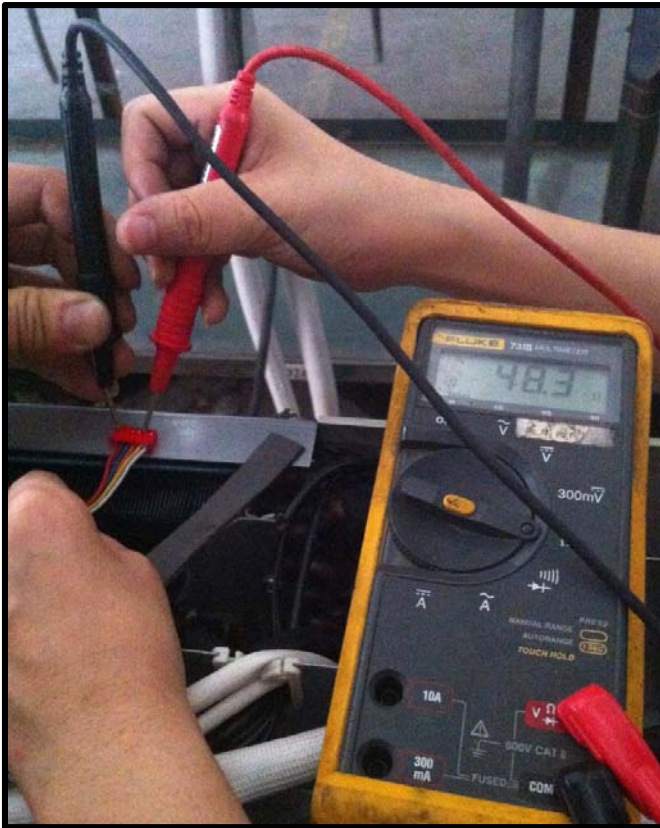

Red - Yellow

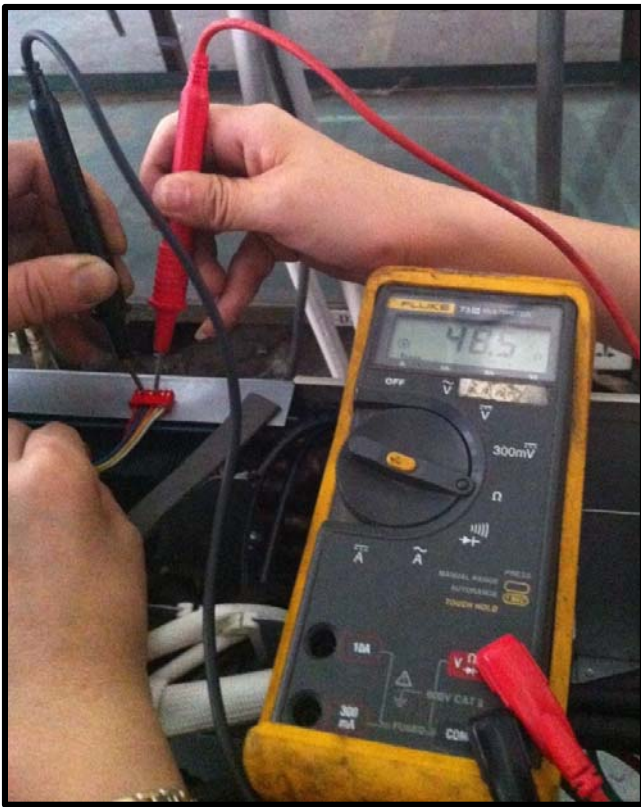

Brown-Orange

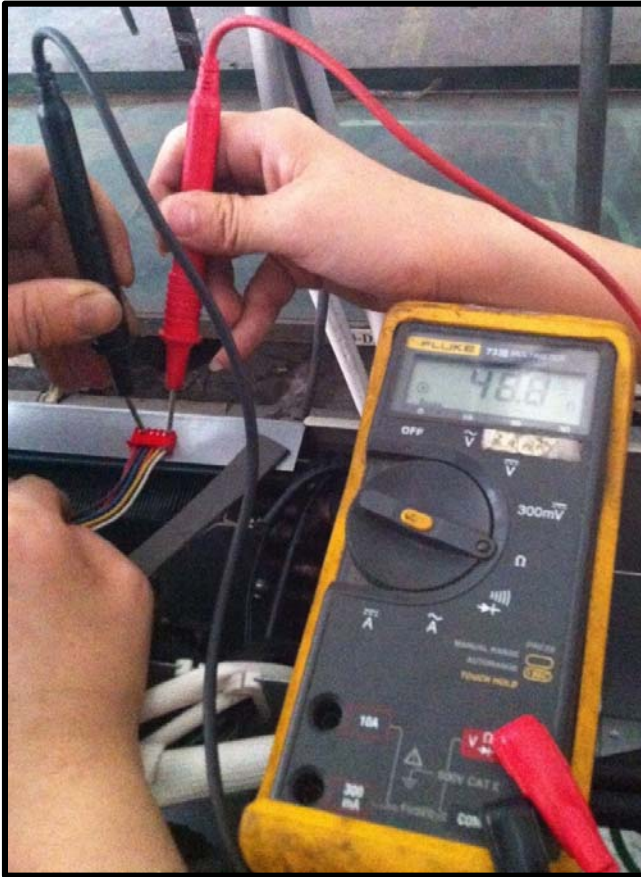



Brown-White

9. Disassembly Instructions

Note: This part is for reference, the photos may have slight difference with your machine.

➤ DUAL (2 ZONE) OUTDOOR UNIT (WCA30 metal plate)

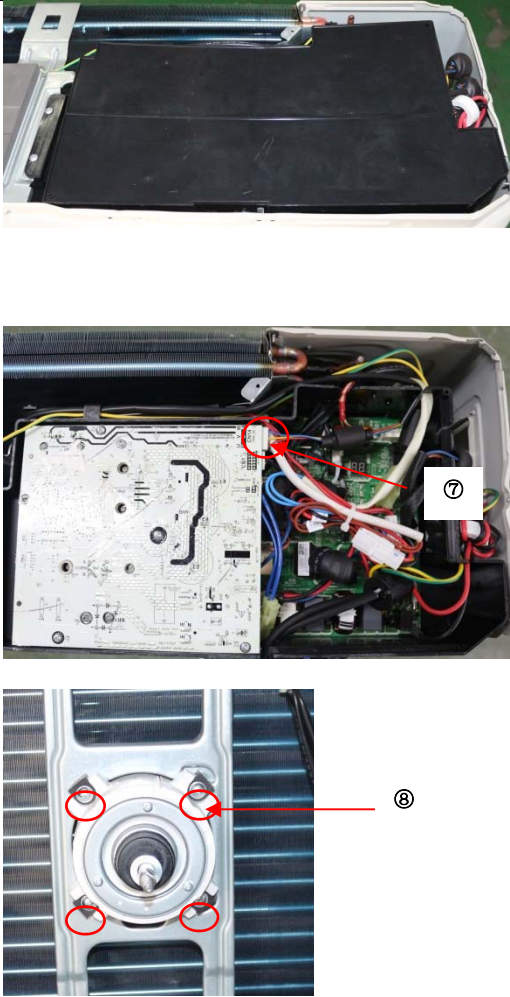
No	Part name	Procedures	Remarks
1	Fan assembly	<p>How to remove the fan assembly.</p> <ol style="list-style-type: none"> 1) Turn off the air conditioner and turn off the power breaker. 2) Remove the screws of air outlet grille(4 screws) 3) Remove the hex nut fixing the fan. 4) Remove the fan. 5) Remove the screws of top cover, and remove the top 	

		<p>cover. (3 screws)</p> <p>6) Remove the cover of electrical control box.</p> <p>7) Disconnect the fan motor connector CN14(3p,white) from the IPM board.</p> <p>8) Remove the fan motor after unfastening four fixing screws.</p>	
2	Panel plate	<p>How to remove the panel plate.</p> <p>1) Remove the screws of front panel, and remove the front panel. (6 screws)</p>	 <p>Screws of front panel</p> <p>Screws of front panel</p>

2) Remove the screws of big handle, and remove the big handle.(4 screws)

Screws of front panel



3) Remove two screws of terminal board and seven screws of right-rear panel, and remove the right-rear panel.

Screws of big handle





Screws of terminal board



Screws of right-rear panel

Screws of right-rear panel

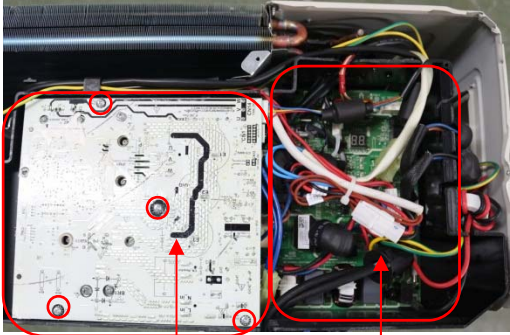

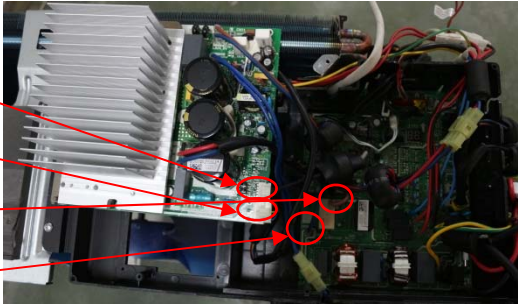
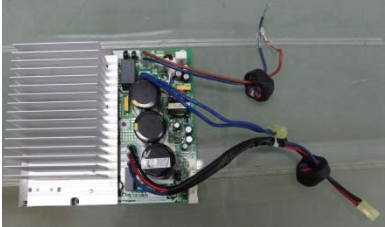
3	Electrical parts	<p>How to remove the electrical parts.</p> <ol style="list-style-type: none"> 1) Perform work of item 1,2. 2) Remove the four screws fixing the IPM board. 3) Unfasten the connector of the reactor. 4) Unfasten the connector of the compressor. 5) Disconnect following 3 pieces of connection wires and connectors between IPM and main control PCB. <ul style="list-style-type: none"> CN1(5p,white) CN14(3p,white) CN4(red or brown) CN5(blue) 6) Remove the IPM board. 7) Disconnect the connectors and wires connected from PCB and other parts. <p>Connectors:</p>	 <p style="text-align: center;">IPM board PCB board</p>   
---	------------------	--	--

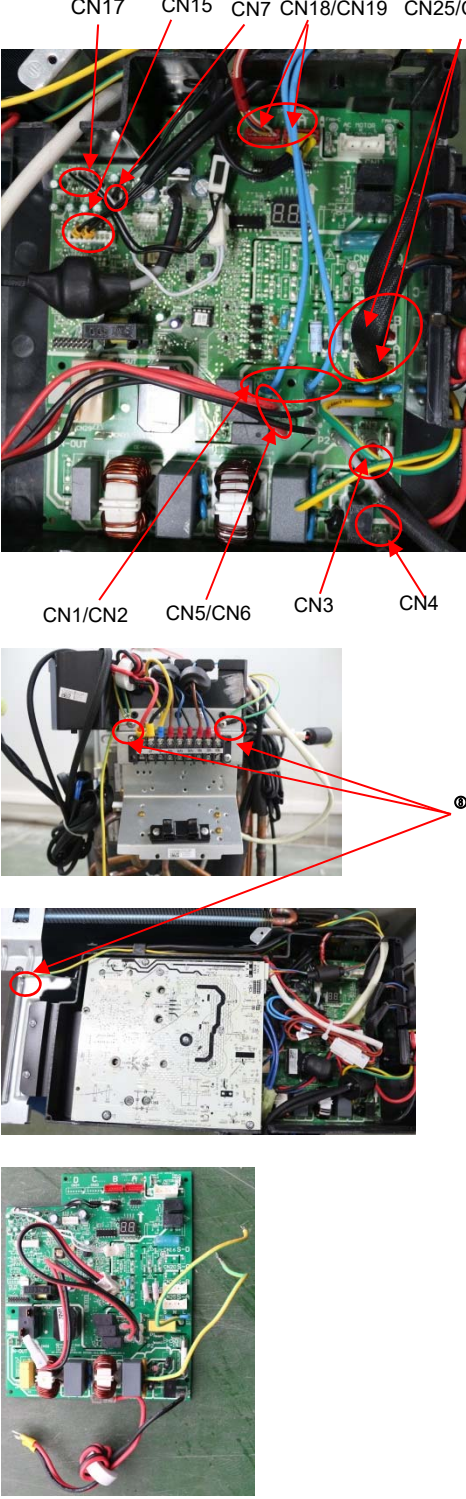
		<p>CN17:T3/T4 temperature sensor (2p/2p,white)</p> <p>CN7: Discharge temperature sensor (2p,white)</p> <p>CN15:T2B-A,B temperature sensor (2p/2p,white)</p> <p>CN18/CN19: Electronic expansive valve A,B (6p/6p,red/red)</p> <p>CN25/CN23: S-A,S-B (3p/3p,white/white)</p> <p>Wires:</p> <p>CN1/CN2: 4-way valve (blue-blue)</p> <p>CN5/CN6: Crankcase heating cable (red-red)</p> <p>CN3:L-IN (red)</p> <p>CN4:N-IN (black)</p> <p>8) Disconnect the grounding wire (yellow-green) after removing the big handle and the right-rear panel.</p> <p>9) Remove the PCB board.</p>	
--	--	---	---

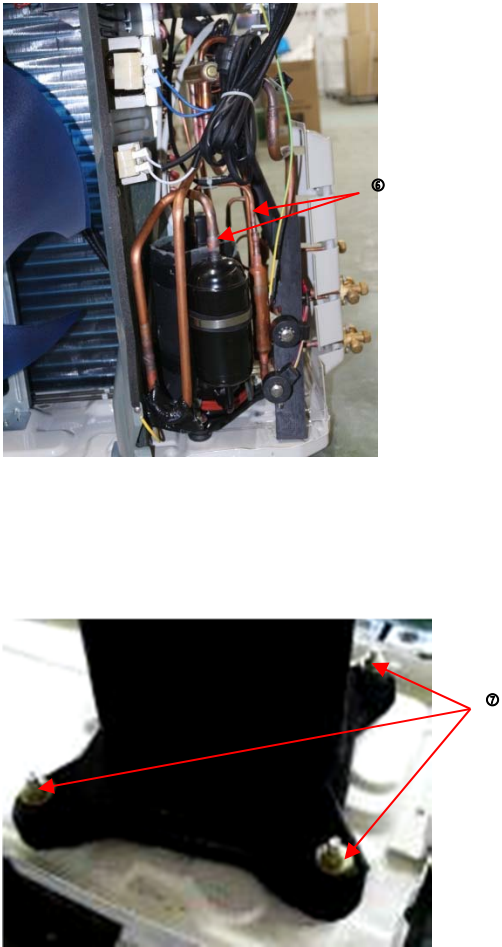
4	Compressor	<p>How to remove the compressor.</p> <ol style="list-style-type: none"> 1) Perform work of item 1,2. 2) Remove the cover of electrical control box. 3) Extract refrigerant gas. 4) Remove the sound insulation material and crankcase heating cable. 5) Remove terminal cover of compressor, and disconnect wires of crankcase electric heater and compressor from the terminal. 6) Remove the discharge pipe and suction pipe with a burner. 7) Remove the hex nuts and washers fixing the compressor to bottom plate. 8) Lift the compressor. 	 <p>The top photograph shows a compressor unit installed within a metal housing. Red arrows point to the copper discharge and suction pipes. A circled '6' is visible on the right side of the image. The bottom photograph shows the compressor being lifted from a white bottom plate. Red arrows point to the mounting points where the compressor was secured to the plate. A circled '7' is visible on the right side of the image.</p>
---	------------	---	---

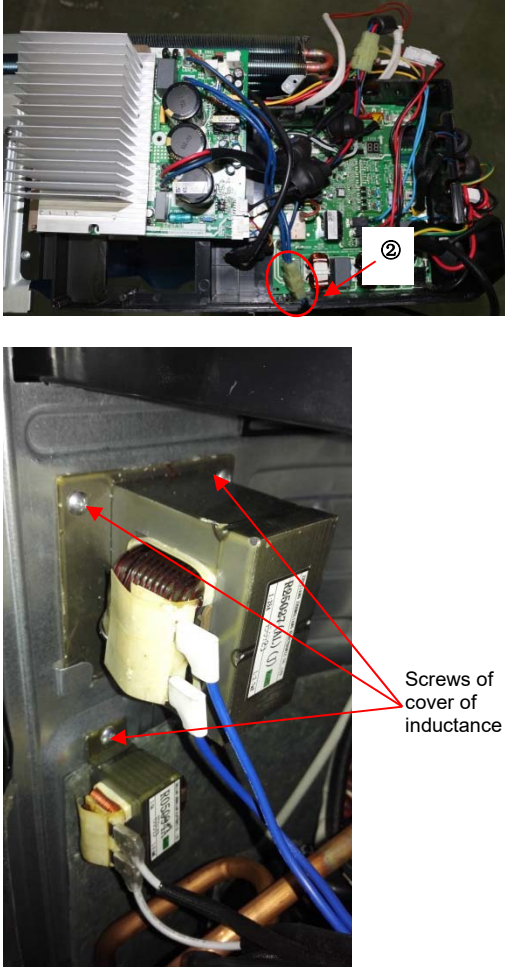
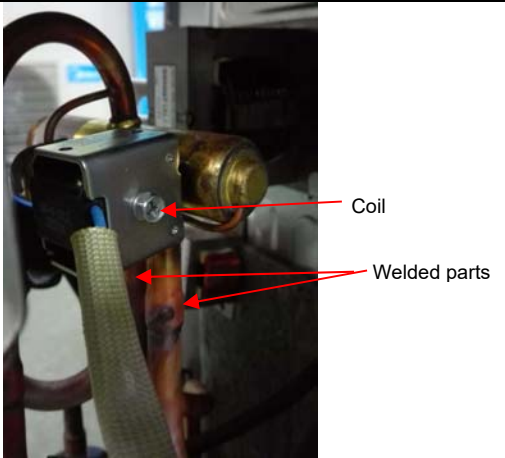
5	Reactor	<p>How to remove the reactor</p> <ol style="list-style-type: none"> 1) Perform work of item 2 2) Unfasten the connector between IPM and reactor. 3) Remove three screws of reactor, and remove the reactor. 	
6	The 4-way valve	<p>How to remove the 4-way valve</p> <ol style="list-style-type: none"> 1) Perform work of item 2. 2) Extract refrigerant gas. 3) Remove the electrical parts from item 3. 4) Remove fixing screw of the coil, and remove the coil. 5) Detach the welded parts of 4-way valve and pipe. 	

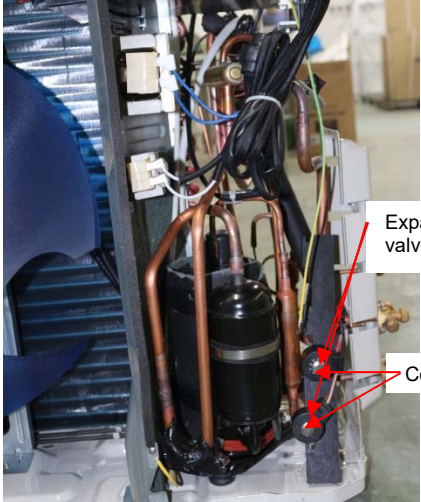
7	The expansion valve	<p>How to remove the expansion valve</p> <ol style="list-style-type: none"> 1) Perform work of item 1,2. 2) Remove the electrical parts from item 3.. 3) Remove the coils. 4) Detach the welded parts of expansion valves and pipes. 	
---	---------------------	--	--

➤ **TRIPLE (3 ZONE) OUTDOOR UNIT (WD30 metal plate)**

No.	Part name	Procedures	Remarks
1	Panel plate	<p>How to remove the panel plate.</p> <ol style="list-style-type: none"> 1) Turn off the air conditioner. Turn off the power breaker. 2) Remove the screws of big handle, and remove the big handle.(4 screws) 3) Remove the screws of top cover, and remove the top cover. (4 screws) 4) Remove the screws of right front side panel, and remove the right front side panel (1 screws) 5) Remove the screws of front 	

panel, and remove the front panel. (8 screws)

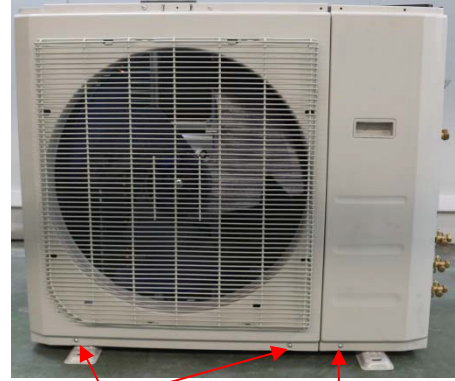

Screws of front panel

Screws of right front side panel

6) Remove two screws of terminal board, screws of water collector and fifteen screws of right-rear panel, and remove the right-rear panel.



Screws of front panel

Screws of front panel

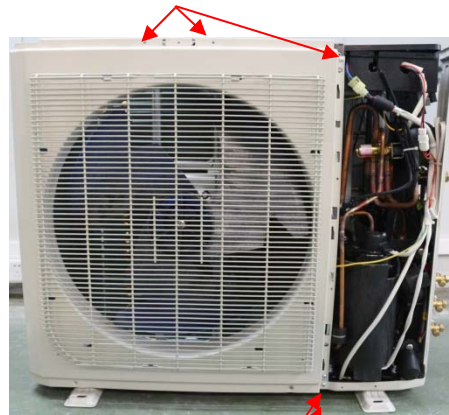

Screws of front panel

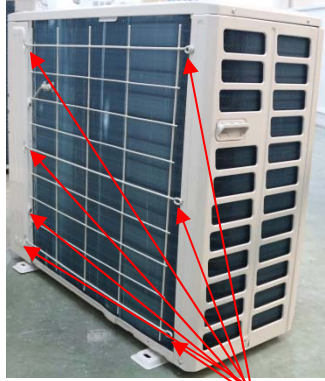



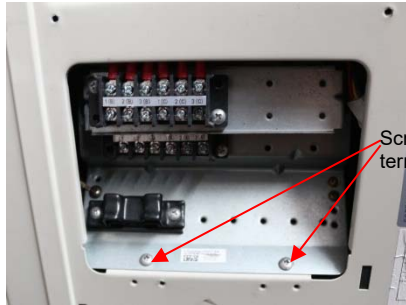

Screws of right-rear panel

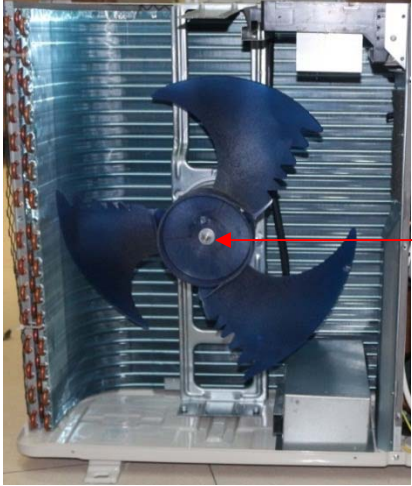

Screws of terminal board

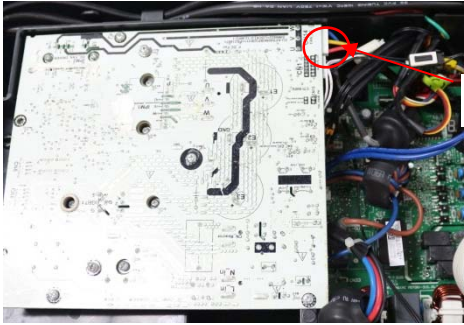
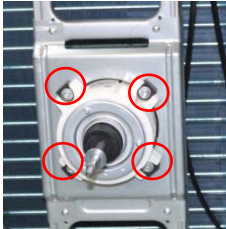

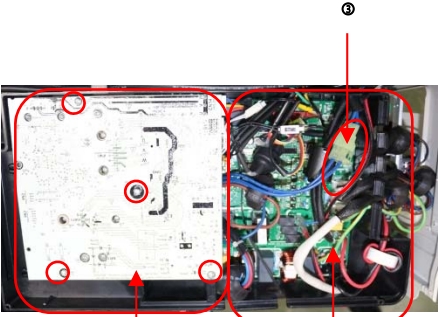
<p>2</p>	<p>Fan assembly</p>	<p>How to remove the fan assembly.</p> <ol style="list-style-type: none"> 1) Remove the top cover, right front side panel and front panel from item 1.step 1~4 2) Remove the hex nut fixing the fan. 3) Remove the fan. 4) Remove the cover of electrical control box cover. 5) Disconnect the fan motor connector CN14(5p,white) from the IPM board. 6) Remove the fan motor after unfastening four fixing screws. 	   
----------	---------------------	---	---

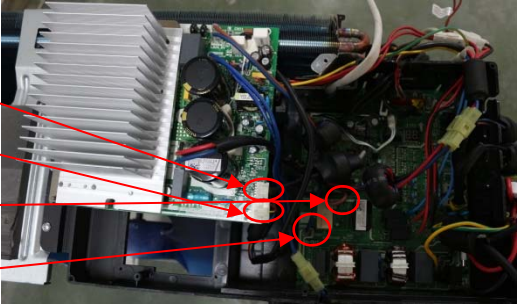
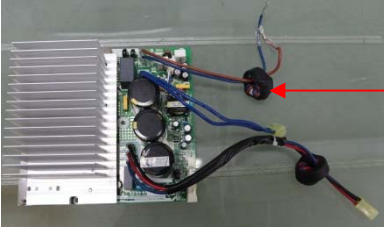
<p>3</p>	<p>Electrical parts</p>	<p>How to remove the electrical parts.</p> <ol style="list-style-type: none"> 1) Perform work of item 1,2. 2) Remove the four screws fixing the IPM board. 3) Unfasten the connector of the reactor. 4) Unfasten the connector of the compressor. 5) Disconnect following 3 pieces of connection wires and connectors between IPM and PCB. 6) Remove the IPM board. 	 <p>IPM board PCB board</p>   <p>CN1(5p,white) CN14(3p,white) CN3(red or brown) CN5(blue)</p> 
----------	-------------------------	---	--

7) Disconnect the connectors and wires connected from PCB and other parts.

Connectors:

CN17:T3/T4 temperature sensor (2p/2p,white)

CN7: Discharge temperature sensor (2p,white)

CN12:Ttop temperature sensor(2p,white)

CN15:T2B-A,B,C temperature sensor (2p/2p/2p,white)

CN18/CN19/CN22: Electronic expansive valve A,B,C (6p/6p/6p,red/red/red)

CN25/CN23/CN20: S-A,S-B,S-C (3p/3p/3p,white/white/white)

Wires:

CN1/CN2: 4-way valve (blue-blue)

CN5/CN6: Crankcase heating cable (red-red)

CN3:L1-IN (red)

CN4:L2-IN (black)

8) Disconnect the grounding wire (yellow-green) after removing the big handle and the right-rear panel.

9) Remove the PCB board.

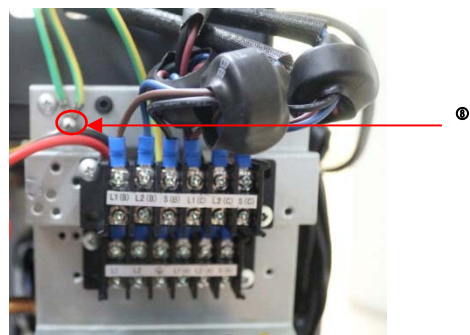
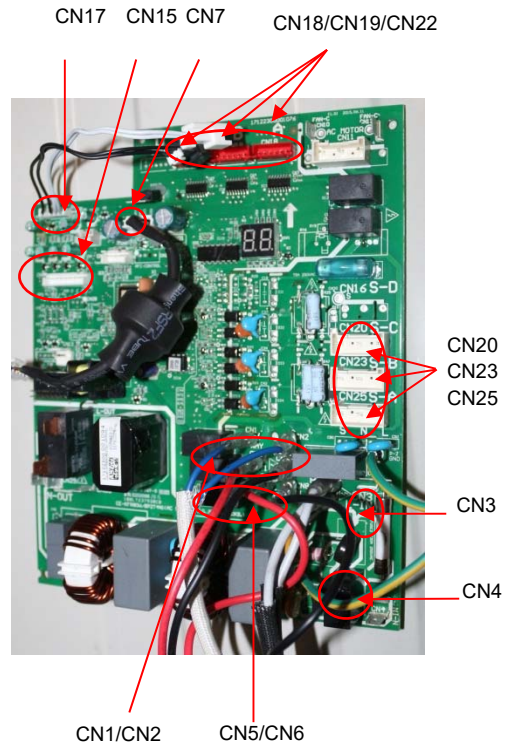

4	Compressor	<p>How to remove the compressor.</p> <ol style="list-style-type: none"> 1) Perform work of item 1,2,3. 2) Remove the electrical control box and partition plate. 3) Extract refrigerant gas. 4) Remove the sound insulation material and crankcase heating cable. 5) Remove terminal cover of compressor, and disconnect wires of compressor thermo and compressor from the terminal. 6) Remove the discharge pipe and suction pipe with a burner. 7) Remove the hex nuts and washers fixing the compressor to bottom plate. 8) Lift the compressor. 	 <p>The top photograph shows the compressor unit installed within a cabinet. It features a black cylindrical body with copper-colored pipes connected to it. Several electrical wires are visible, some connected to terminals. Red arrows point to specific components, and a circled '6' is visible on the right side of the image.</p> <p>The bottom photograph is a close-up view of the compressor's base. It shows a black metal component with two mounting points where it is secured to a white surface. Red arrows point to these mounting points, and a circled '7' is visible on the right side of the image.</p>
---	------------	--	--

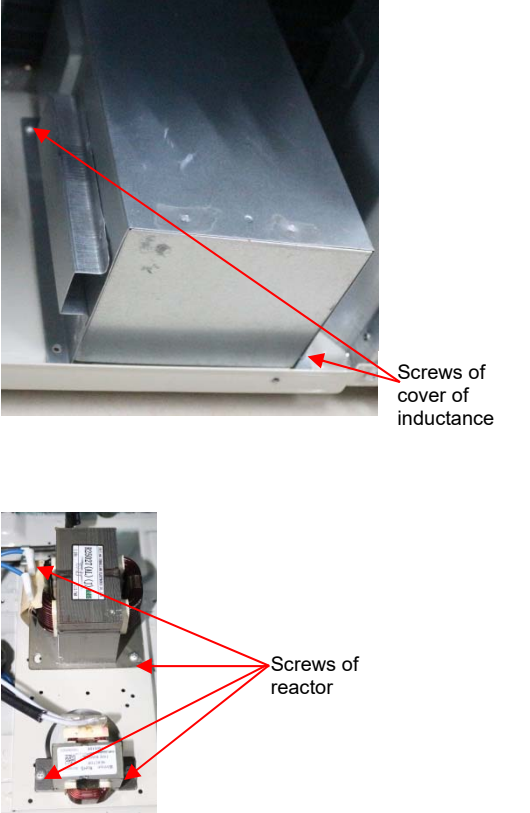
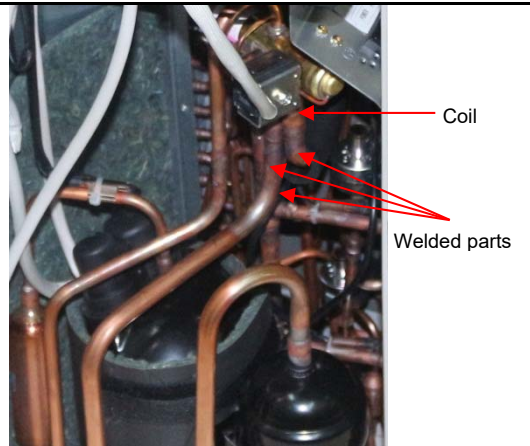
5	Reactor	<p>How to remove the reactor</p> <ol style="list-style-type: none"> 1) Perform work of item 1,2 2) Unfasten the connector between IPM and reactor. 3) Remove two screws of cover of inductance, and remove the cover of inductance 4) Disconnect two pieces of wires connected from the cover of inductance. 5) Remove four screws of reactor, and remove the reactor. 	
6	The 4-way valve	<p>How to remove the 4-way valve</p> <ol style="list-style-type: none"> 1) Perform work of item 1,2. 2) Extract refrigerant gas. 3) Remove the electrical parts from item 3. 4) Remove fixing screw of the coil, and remove the coil. 5) Detach the welded parts of 4-way valve and pipe. 	

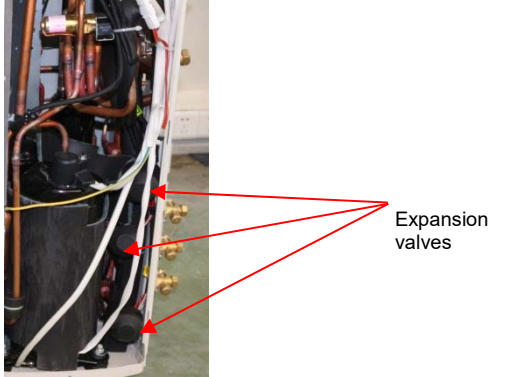
7	The expansion valve	<p>How to remove the expansion valve</p> <ol style="list-style-type: none"> 1) Perform work of item 1,2. 2) Remove the electrical parts from item 3. 3) Remove the coils. 4) Detach the welded parts of expansion valves and pipes. 	 <p>Expansion valves</p>
---	---------------------	---	--

➤ **QUAD (4 ZONE) OUTDOOR UNIT (WD30 metal plate)**

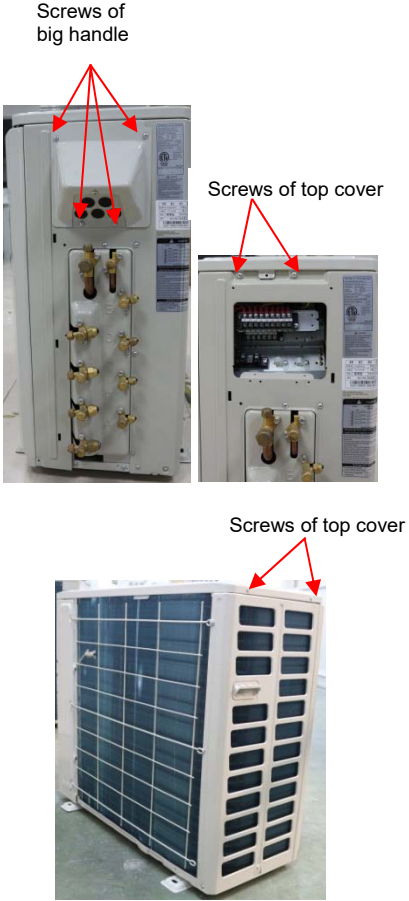
No	Part name	Procedures	Remarks
1	Panel plate	<p>How to remove the panel plate.</p> <ol style="list-style-type: none"> 1) Turn off the air conditioner. Turn off the power breaker. 2) Remove the screws of big handle, and remove the big handle.(4 screws) 3) Remove the screws of top cover, and remove the top cover. (4 screws) 4) Remove the screws of right front side panel, and remove the right front side panel (1 screw) 5) Remove the screws of front 	 <p>Screws of big handle</p> <p>Screws of top cover</p> <p>Screws of top cover</p>

panel, and remove the front panel. (8 screws)

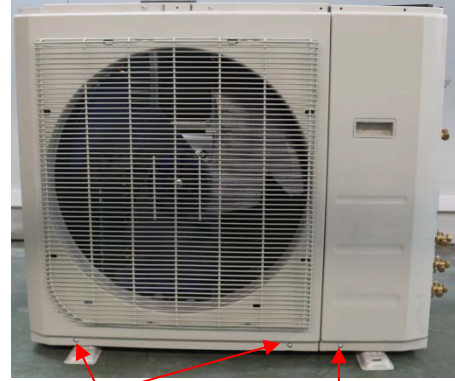

Screws of front panel

Screws of right front side panel

6) Remove two screws of terminal board, screws of water collector and fifteen screws of right-rear panel, and remove the right-rear panel.



Screws of front panel

Screws of front panel

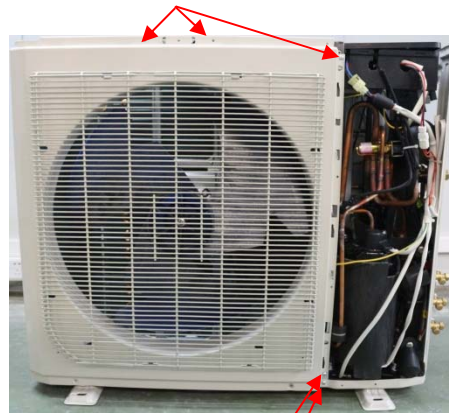

Screws of front panel

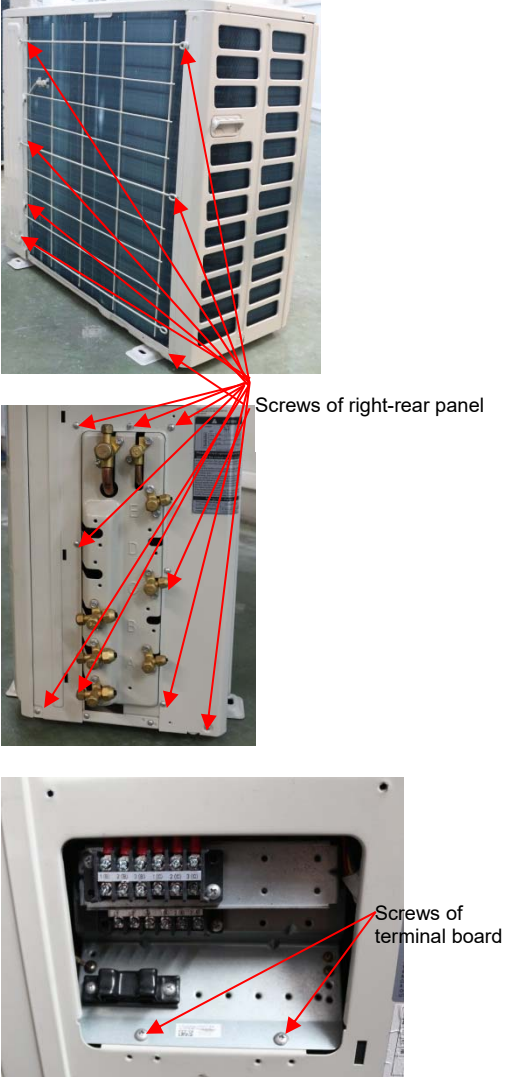
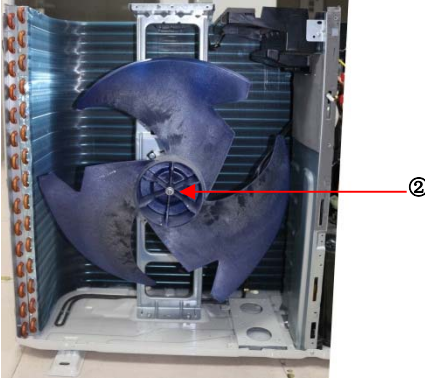
			 <p>Screws of right-rear panel</p> <p>Screws of terminal board</p>
2	Fan assembly	<p>How to remove the fan assembly.</p> <ol style="list-style-type: none"> 1) Remove the top cover, right front side panel and front panel from item 1.step 1~4 2) Remove the hex nut fixing the fan. 	 <p>②</p>

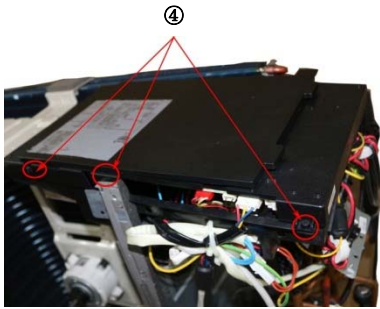
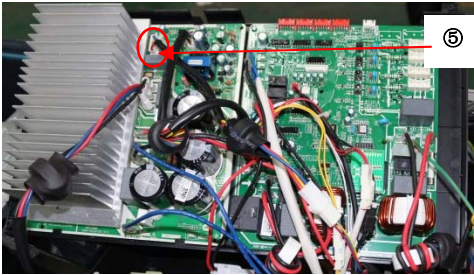
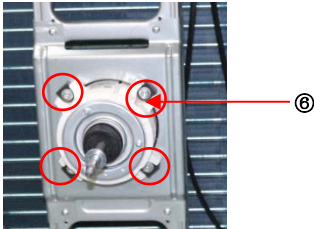
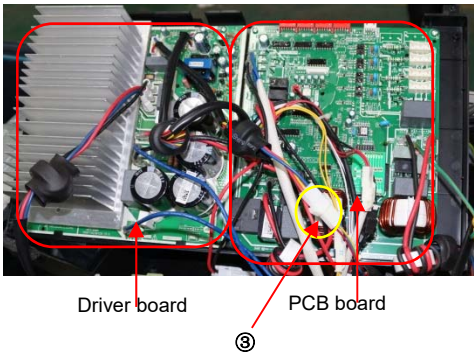
		<p>3) Remove the fan.</p> <p>4) Unfix the hooks and remove the screws, then open the electronic control box.</p> <p>5) Disconnect the fan motor connector CN19(3p,white) from the driver board.</p> <p>6) Remove the fan motor after unfastening four fixing screws.</p>	  
<p>3</p>	<p>Electrical parts</p>	<p>How to remove the electrical parts.</p> <p>1) Perform work of item 1,2.</p> <p>2) Unfasten the connector of the reactor.</p> <p>3) Unfasten the connector of the compressor.</p> <p>4) Unfasten the connector of the PFC inductor.</p> <p>5) Disconnect following 3</p>	

pieces of connection wires and connectors between driver board and PCB.

CN55-CN7(7p,white)

CN54-CN6(red)

CN53-CN5(black)

6) Remove the fixing screws, then move the driver board.

7) Disconnect the connectors and wires connected from PCB and other parts.

Connectors:

CN8:T3/T4 temperature sensor (2p/2p,white)

CN33: Discharge temperature sensor (2p,white)

CN13:T2B-A,B,C,D temperature sensor (2p/2p/2p/2p,white)

CN18/CN17/CN21/CN20: Electronic expansive valve A,B,C,D (6p/6p/6p,red/red/red)

CN30/CN29/CN28/CN27: S-A,S-B,S-C,S-D (3p/3p/3p/3p,white)



CN9: High and low pressure switch (2p/2p, white)

Wires:

CN3/CN22: 4-way valve (blue-blue)

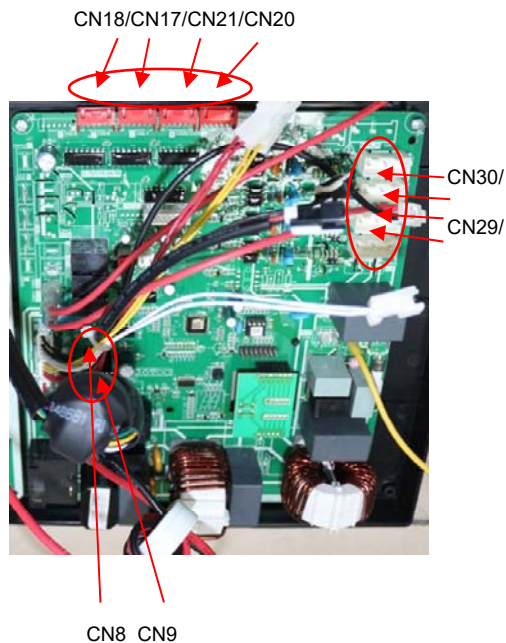
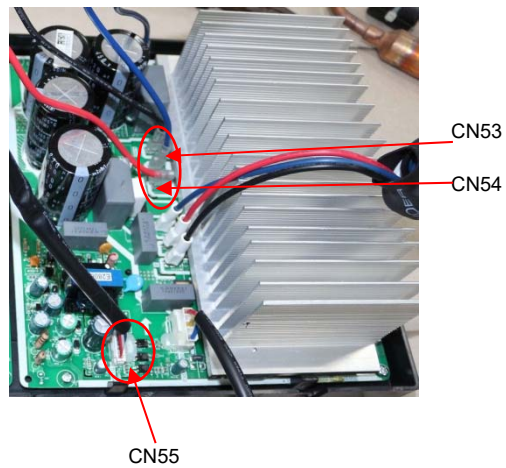
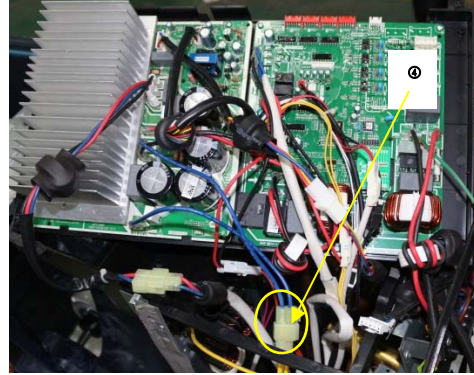
CN4/CN40: Crankcase heating cable (black-red)

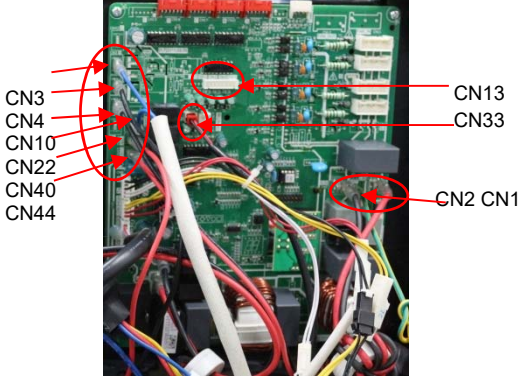
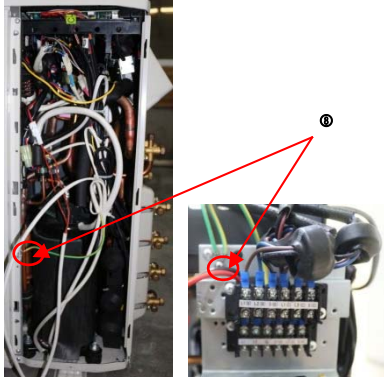

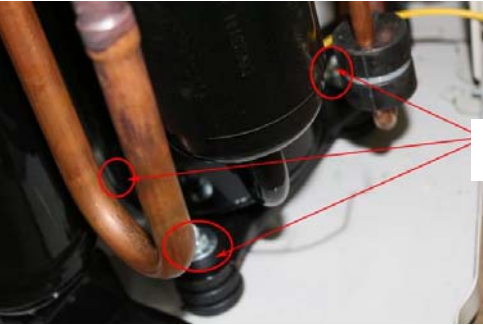
		<p>CN10/CN44: Crankcase heating cable (black-red)</p> <p>CN1:L1-IN (red)</p> <p>CN2:L2-IN (black)</p> <p>8) Disconnect the grounding wire (yellow-green) after removing the right-rear panel.</p> <p>9) Remove the PCB board.</p>	 
4	Compressor	<p>How to remove the compressor.</p> <p>1) Perform work of item 1,2,3.</p> <p>2) Remove the electrical control box and partition plate.</p> <p>3) Extract refrigerant gas.</p> <p>4) Remove the sound insulation material and crankcase heating cable.</p> <p>5) Remove terminal cover of compressor, and disconnect wires of compressor thermo and compressor from the terminal.</p>	 

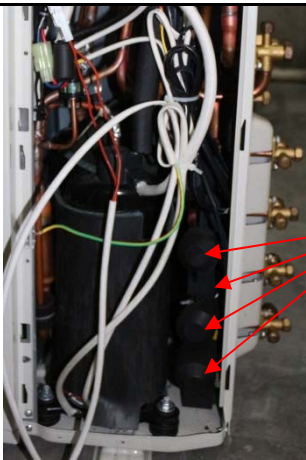
		<p>6) Remove the discharge pipe and suction pipe with a burner.</p> <p>7) Remove the hex nuts and washers fixing the compressor to bottom plate.</p> <p>8) Lift the compressor.</p>	
5	The 4-way valve	<p>How to remove the 4-way valve</p> <ol style="list-style-type: none"> 1) Perform work of item 1,2. 2) Extract refrigerant gas. 3) Remove the electrical parts from item 3. 4) Remove fixing screw of the coil, and remove the coil. 5) Detach the welded parts of 4-way valve and pipe. 	 <p>Coil</p> <p>Welded parts</p>
6	The expansion valve	<p>How to remove the expansion valve</p> <ol style="list-style-type: none"> 1) Perform work of item 1,2. 2) Remove the electrical parts from item 3. 3) Remove the coils. 4) Detach the welded parts of expansion valves and pipes. 	 <p>Expansion valves</p>

➤ **QUINT (5 ZONE) OUTDOOR UNIT (WE30 metal plate)**

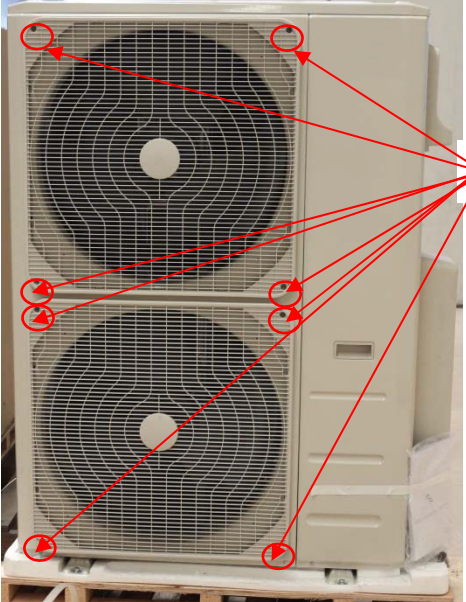
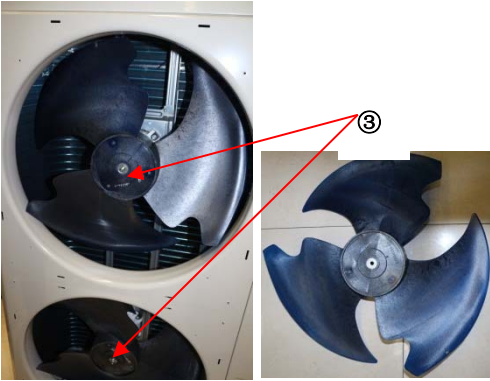
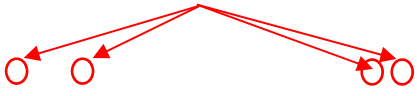
No	Part name	Procedures	Remarks
1	Fan assembly	<p>How to remove the fan assembly.</p> <ol style="list-style-type: none"> 1) Turn off the air conditioner. Turn off the power breaker. 2) Remove the screws of air outlet grille(8 screws) 3) Remove the hex nut fixing the fan. 4) Remove the fan. 5) Remove the screws of top cover, and remove the top cover. (4 screws) 	  <p>Screws of top</p> 

6) Remove the screws of front side panel, and remove the front side panel (1 screw)



7) Disconnect the fan motor connectors FAN1(3p,white) and FAN2(3p,white) from DC motor driver board.



8) Remove the fan motor after unfastening fixing screws.

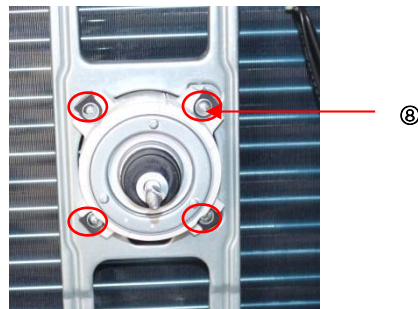
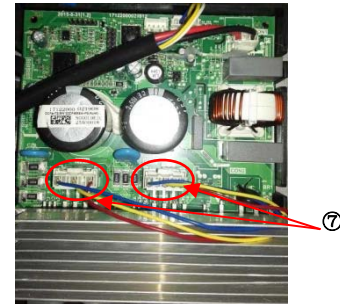

2	Panel plate	<p>How to remove the panel plate.</p> <p>4) Remove big handle.(2 screws) and water collector(2 screws)</p> <p>5) Remove 2 screws of terminal board and 15 screws of right-rear panel, and remove the right-rear panel.</p>	
3	Electrical parts	<p>How to remove the electrical parts.</p> <p>1) Perform work of item 1 step 5~6 and item 2.</p>	

2) Disconnect the fan motor Connector(5p,white) from the IPM board.



3) Disconnect following 8 pieces of connection wires and connectors between IPM and other parts.

CN2(yellow)

CN1(red)

CN6(black)

CN3(yellow)

U、V、W(black)

CN9(10p,white)

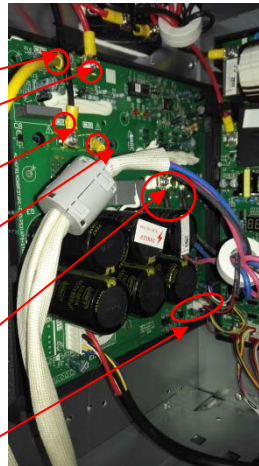

4) Remove the fixing screws then remove the IPM board.





5) Disconnect the connectors and wires connected from PCB and other parts.

Connectors:

CN8: Discharge temperature sensor

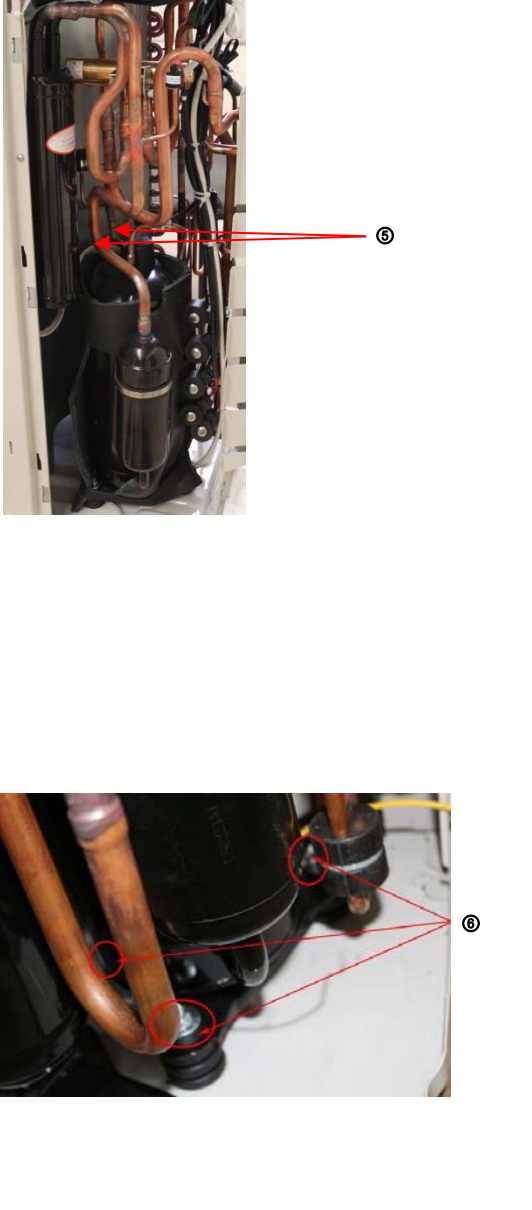
		<p>(2p,white)</p> <p>CN12: Heatsink temperature sensor(2p,red)</p> <p>CN9:T3/T4 temperature sensor (2p/2p,white)</p> <p>CN11:T2B-A,B,C,D,E temperature sensor (2p/2p/2p/2p/2p,white)</p> <p>CN15/CN23/CN26/CN30/CN33: Electronic expansive valve (6p/6p/6p/6p/6p,red)</p> <p>CN37/CN29/CN21/CN16/CN13: S-A,S-B,S-C,S-D,S-E (3p/3p/3p/3p/3p,white)</p> <p>CN10: High and low pressure switch (2p/2p, white)</p> <p>Wires:</p> <p>CN17/CN18: 4-way valve (blue-blue)</p> <p>CN19/CN20: connected to crankcase heating cable. (black-red)</p> <p>CN24/CN25: Electric heater of chassis (orange-orange)</p> <p>CN1:L-IN (red)</p> <p>CN3:N-IN (black)</p> <p>6) Disconnect the grounding wire (yellow-green) after removing the big handle.</p> <p>7) Remove the PCB board.</p>	    
--	--	---	--

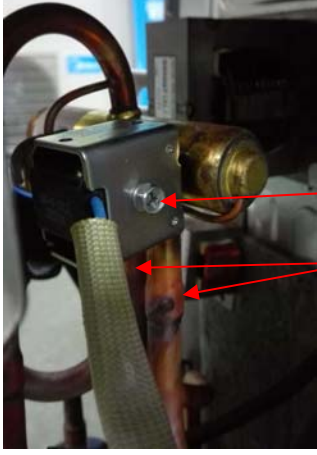
4	Compressor	<p>How to remove the compressor.</p> <ol style="list-style-type: none"> 1) Perform work of item 1 step 5~6 and item 2.. 2) Extract refrigerant gas. 3) Remove the sound insulation material and crankcase heating cable. 4) Remove terminal cover of compressor, and disconnect wires of crankcase electric heater and compressor from the terminal. 5) Remove the discharge pipe and suction pipe with a burner. 6) Remove the hex nuts and washers fixing the compressor to bottom plate. 7) Lift the compressor. 	 <p>The top photograph shows the compressor assembly within a unit. A red arrow points from a circled '5' on the right to a specific component on the compressor. The bottom photograph is a close-up of the compressor's base, showing three red circles highlighting hex nuts and washers. A circled '6' on the right has lines pointing to these fasteners.</p>
---	------------	--	---

5	The 4-way valve	<p>How to remove the 4-way valve</p> <p>6) Perform work of item 1 step 5~6 and item 2..</p> <p>7) Extract refrigerant gas.</p> <p>8) Remove the electrical parts from item 3.</p> <p>9) Remove fixing screw of the coil, and remove the coil.</p> <p>10) Detach the welded parts of 4-way valve and pipe.</p>	 <p>Coil</p> <p>Welded parts</p>
6	The expansion valve	<p>How to remove the expansion valve</p> <p>5) Perform work of item 1,2.</p> <p>6) Remove the electrical parts from item 3..</p> <p>7) Remove the coil.</p> <p>8) Detach the welded parts of expansion valves and pipes.</p>	 <p>Expansion valves</p>