

DUCTLESS MINI SPLIT SYSTEM AIR CONDITIONER / HEAT PUMP

PIONEER®

WYT-19 Inverter Series For 9,000-36,000 BTU/hr Systems

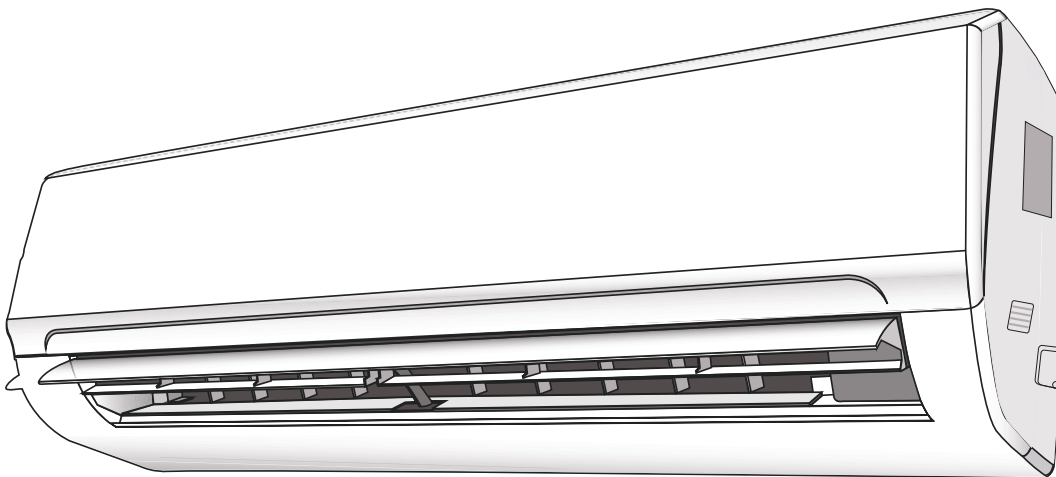

Installation & User's Manual

IMPORTANT NOTICE:

Please read this manual carefully before installing or operating your new air conditioning system. Be sure to save this manual for future reference.



REV111521

Table of Contents

Installation Manual

0	Safety Precautions.....	4
1	System Components.....	6
2	Included Accessories.....	7
3	Indoor Unit Overview.....	8
	4	Operating Instructions..... 9
	1. Remote Buttons Overview.....	9
	2. Remote Controller LED Screen And Icons....	10
	3. Handling the Remote Controller.....	11
	4. Controlling the System's Airflow.....	12
	5. Indoor Unit Mode Settings.....	13
	6. Extra Options and Settings.....	15
	7. Managing the Timer Features.....	17
	8. Other Features.....	18
	9. Operating Temperature Notes.....	20
5	Maintenance Instructions.....	21
6	Indoor Unit Installation.....	22
	1. Indoor Unit Installation Location Selection.....	22
	2. Pre-Mounting Instructions.....	23
	3. Preparing the Refrigerant Piping.....	26
	4. Preparing the Drain Line.....	27
	5. Preparing the Signal Cable.....	28
	6. Routing the Copper Lines and Mounting the Unit.....	29

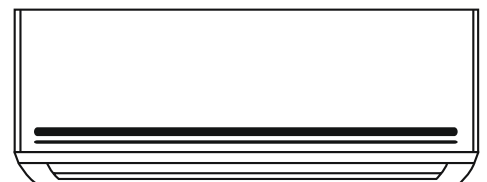
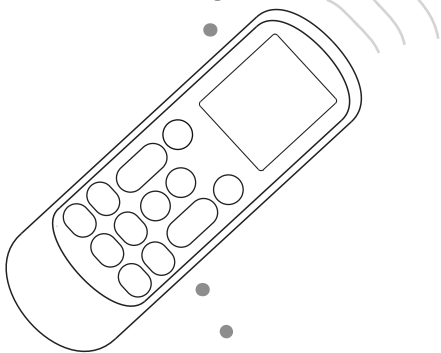
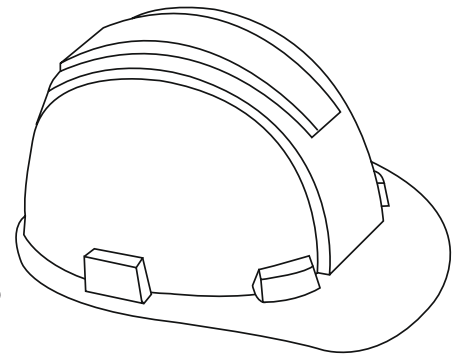

7 Outdoor Unit Installation..... 30

1. Outdoor Unit Installation Location Selection..... 30
2. Mounting Instructions..... 31
3. Electrical Wiring of the Outdoor Unit..... 32
4. Connection of Refrigerant Piping..... 34
5. Evacuating the Lineset..... 37

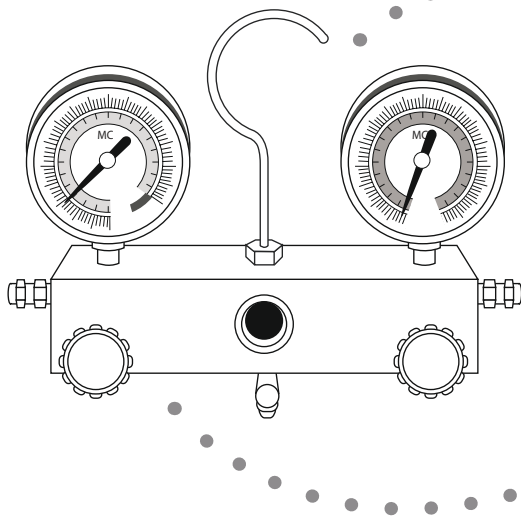
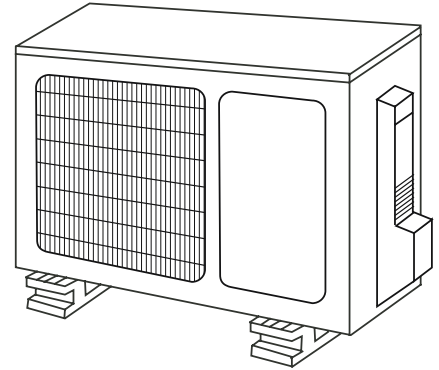

8 Leak Check/Test Run..... 39

1. Electrical and Gas Leak Check..... 39
2. Test Run..... 40

9 Troubleshooting..... 41

A Appendix..... 42

1. Anchoring the Outdoor Unit Guide..... 42
2. Guidelines for Drilling the Wall Hole.... 43
3. Simplified Wiring Diagram..... 44
4. European Disposal Guidelines..... 45

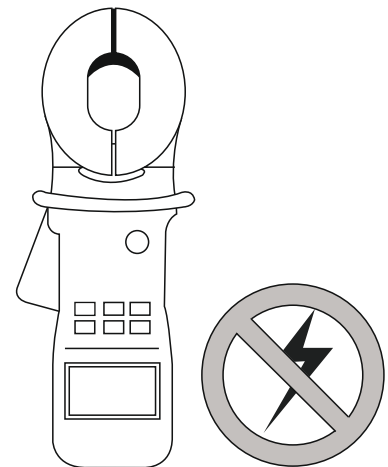

Safety Precautions

Read and Understand All Safety Precautions Prior to Installation

Improper installation due to negligence of instructions may result in serious damage or injury.

The magnitude of potential damages or injuries is classified as either a **WARNING** or a **CAUTION**.



WARNING

This symbol indicates that ignoring the related instructions may cause death, or serious injury.



CAUTION

This symbol indicates that ignoring the related instructions may cause moderate injury to nearby persons, and/or damage to your appliance or other property.



DANGER

This symbol indicates that you must never perform the action shown.



WARNING

- ⊘ Do not power the system using an extension cable or with wiring smaller than the specified gauge. Do not share the electrical circuit with other appliances. Improper or insufficient power supply can cause undesirable operation, fire, or electrical shock.
 - ⊘ When connecting refrigerant piping, do not let any substances or gases other than the specified refrigerant enter the unit. The presence of other gases or substances will lower the unit's capacity, and can cause abnormally high pressure in the refrigeration cycle. This can also cause explosion and injury, as well as permanent equipment failure. Remember: No dust, humidity or air is allowed to enter.
 - ⊘ Do not allow children to play with or around the air conditioner. Children near the unit must be supervised at all times.
1. Installation must be performed by a licensed and trained technician. Defective installation can cause water leakage, electrical shock, or fire. The usage of proper tools is a requirement.
 2. Installation must be performed according to the installation instructions. Improper installation can cause water leakage, undesired performance, electrical shock, or fire.
(In North America, installation must be performed in accordance with the requirements of NEC and CEC, by authorized personnel only.)
 3. Contact a qualified and licensed HVAC technician for any repairs or maintenance of this unit.
 4. Only use the included accessories, parts, and specified items for installation. Using non-standard parts can cause water leakage, electrical shock, fire, and can cause total unit failure.
 5. Install the unit on top of a firm structure that can fully support its weight. If the chosen location cannot support the unit's weight, or the installation is not done properly, the unit may fall and cause serious injury and damage.

WARNING

6. For all electrical work, follow all local and national wiring standards, regulations, and especially this Installation Manual. You must use an independent circuit and a dedicated breaker to supply power. Do not connect other appliances to the same circuit. Insufficient electrical capacity or defects in electrical work can cause electrical shock or fire.
7. For all electrical work, use the specified cables. Connect cables tightly, and clamp them securely to prevent external forces from damaging the terminals. Improper electrical connections can overheat and cause fire, and may also cause shock.
8. All wiring must be properly arranged to ensure that the control board cover can close properly. If the control board cover is not closed properly, it can lead to corrosion and cause the connection points on the terminal to heat up, catch fire, or cause electrical shock.
9. In certain functional environments, such as kitchens, server rooms, etc., the use of specially designed air-conditioning units is highly recommended. This is intended as a general comfort cooling system.
10. If the supply cord is damaged, it must be replaced by a certified service agent or similarly qualified technicians, in order to avoid a hazard.
11. This appliance can be used by children aged 8 years and above, as well as persons with reduced physical, sensory, or mental capabilities, or lack of experience or knowledge, if they have been given supervision or instruction concerning use of the appliance in a safe way, and understand the hazards involved. Children shall not play with or near the appliance. Cleaning and user maintenance shall not be done or attempted by children or untrained personnel without proper supervision.

CAUTION

- ⊘ For units that have an auxiliary electric heater, do not install the unit within 1 meter (3 feet) of any combustible materials.
 - ⊘ Do not install the unit in a location that may be exposed to combustible gas leaks. If combustible gas accumulates around the unit, it may cause fire.
 - ⊘ Do not operate your air conditioner in a highly humid space, such as bathrooms or laundry rooms. Exposure to high humidity or water can cause electrical components to short circuit.
1. The product must be properly grounded at the time of installation, else electrical shock may occur.
 2. Install drainage piping according to the instructions in this manual. Improper drainage may cause water damage to your home and property.

Note about Fluorinated Gasses

1. This air-conditioning unit contains fluorinated gasses. For specific information on the type of gas and the amount, please refer to the relevant label on the unit itself.
2. Installation, service, maintenance, and repair of this unit must be performed by a certified HVAC technician.
3. Product uninstallation and recycling must be performed by a certified HVAC technician.
4. If the system has a leak-detection feature installed, it must be checked for leaks at least every 12 months.
5. When the unit is being checked for leaks, proper logging and record-keeping of all checks is strongly recommended.

System Components



High Wall-Mounted Air Conditioner

The system is made up of two or more units connected together via insulated copper pipes and an electrical communication cable. The indoor unit is mounted onto one of the walls in the room that is to be conditioned. The outdoor unit is installed on the ground outside or on the wall of the dwelling using suitable mounting brackets.

INDOOR UNIT

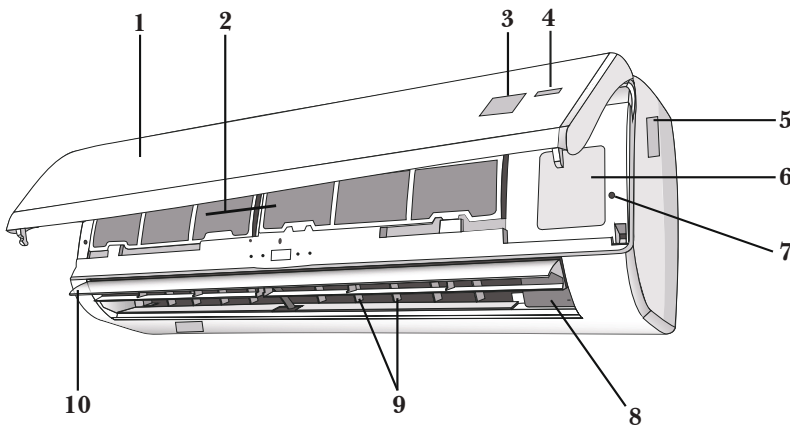

No.	Description
1	Front Panel
2	Air Filters
3	LED Display
4	Signal Receiver
5	Indoor Unit Rating Label
6	Terminal Block Cover
7	Emergency (Manual) Button
8	Ionizer Generator (Optional)
9	Deflectors
10	Airflow Direction Louver

OUTDOOR UNIT

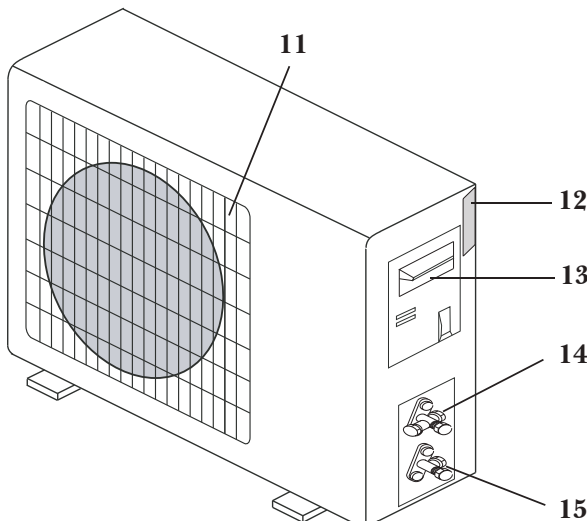

No.	Description
11	Air Outlet Grille
12	Outdoor Unit Nameplate
13	Terminal Block Cover
14	Gas (Suction) Line Valve
15	Liquid Line Valve

Note: Serial Numbers are typically located behind the electronic control box cover cap of either unit.











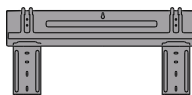

Note: The illustrations above are only intended to be a simple diagram of the appliance, and may not fully correspond to the actual appearance of the system. Technical data is printed on the system's labels.

Included Accessories

2

Accessories and Components:

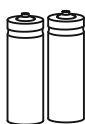
The air conditioning system comes with the following accessories. Use all of the installation parts and accessories to install the air conditioner. Improper installation may cause the equipment to fail, or result in water leakage, electrical shock, or fire.

Name	Appearance	Name	Appearance
1x Installation and Owner's Manual		1x Indoor Unit Mounting Plate	
1x Warranty Card		1x Set of Mounting Plate Screws	
1x 16 ft. Communication Cable		1x Plastic Drain Joint Plug	
1x 16 ft. Insulated Copper Pipe		1x Condensate Drain Hose	
1x Remote Controller		1x Wrapping Tape	
1x Remote Controller Holder		1x Wall-Hole Packing Sealant	
2x Remote Controller Batteries		1x Wall Sleeve	

Connecting Pipe Diameters		
BTU Capacity	Gas Line	Liquid Line
9000	3/8"	1/4"
12000		
18000	1/2"	1/4"
24000		
36000	5/8"	1/4"

Indoor Unit Overview



Front Panel Display

No.	LED Icon	Symbol	Description
1	POWER	⏻	Indicates that the unit is currently powered on
2	SLEEP	☾	Indicates that the system is currently in SLEEP mode
3	Temp. Display	88	Displays the current set temperature or any error codes
4	TIMER	⌚	Indicates that the TIMER function has been set
5	RUN	✻	Indicates that the fan is currently on and running

The shape and position of switches and indicators may vary according to the model, however the functions remain the same. There may be variances between the amount of digits that are shown on the remote (3) vs. the amount on the indoor unit (2).

Emergency Manual Button And Auto-Restart Function

The emergency button is located at the terminal block cover of the unit under the front panel.

Front Panel

Emergency Button

Emergency Manual Button

If the remote controller fails to operate the system, proceed as follows:

- Open and lift the front panel up at an angle to gain access to the emergency button.
- Press the manual button once to start the unit in COOL mode.
- Press the button again within 3 seconds to start the unit in HEAT mode.
- Press a 3rd time within 5 seconds to turn off the unit.

Auto-Restart Feature

This appliance is programmed with an auto-restart function.

In case of sudden power failure, the control module will remember the settings configured before power loss.

When power is restored, the unit will restart automatically, and will be set to the previous settings, which were preserved with this memory function.

Operating Instructions

4

Remote Buttons Overview

Button	Description
	Turns the air conditioner on or off
TEMP ^	Decreases set temperature, set timing, or navigates the functional menu
TEMP v	Increases set temperature, set timing, or navigates the functional menu
MODE	Selects the mode of operation (Auto, Cool, Dry, Fan, and Heat modes)
ECO	Activates/deactivates the ECO feature
	Long press to activate the 46°F “Away from Home” freeze protection setting.
TURBO	Activates/deactivates the TURBO feature, which allows the system to reach set temperatures quicker
FAN	Configures the fan speed (Auto, Low, Mid, and High)
TIMER	Configures the automatic on/off times
SLEEP	Toggles the system’s Sleep Mode
DISPLAY	Turns the LED display on or off
SWING◇	Activates the up-down louver motor
SWING<>	Activates the left-right louver motor
I FEEL	Activates the system’s Follow Me mode
MUTE	Puts the system into silent mode
LOCK	Press MODE+TIMER for child-lock

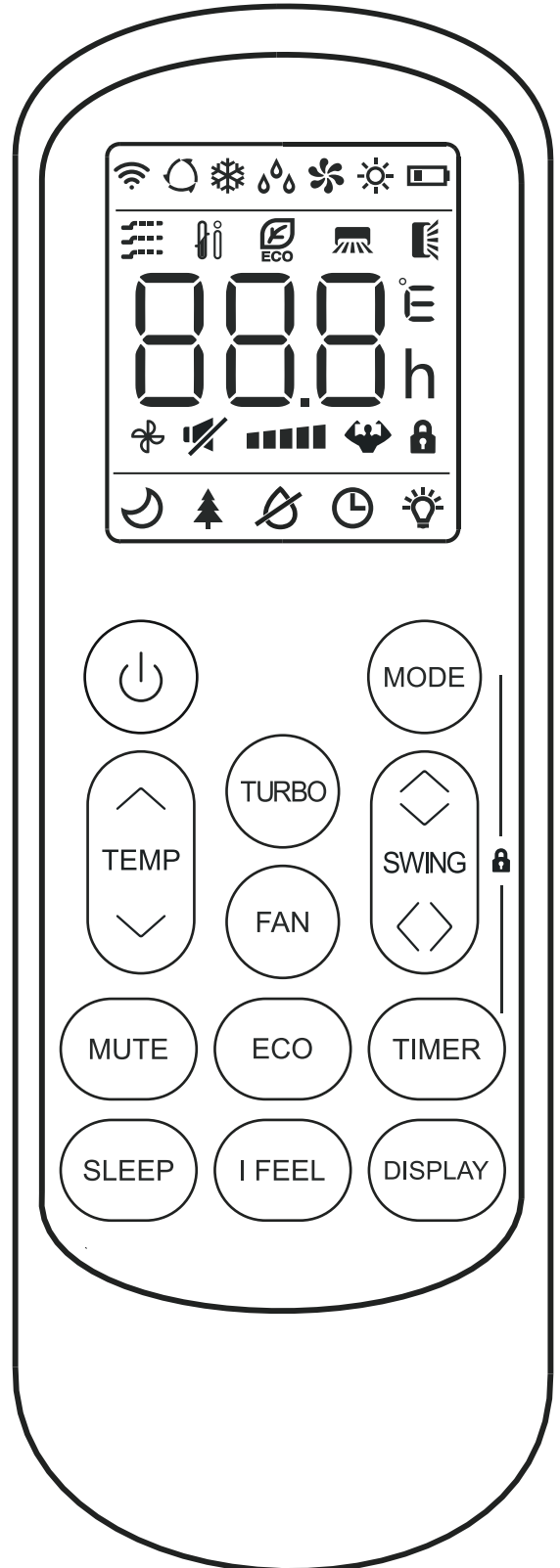

- The display and some features of the remote control may vary according to the model of the system.*
- The shape and positions of the buttons and indicators may vary according to the model of the system, but the features and functionality would remain the same.*
- The unit will confirm the successful reception of each button command with a beep.*

Operating Instructions

4

Remote Controller LED Screen and Icons

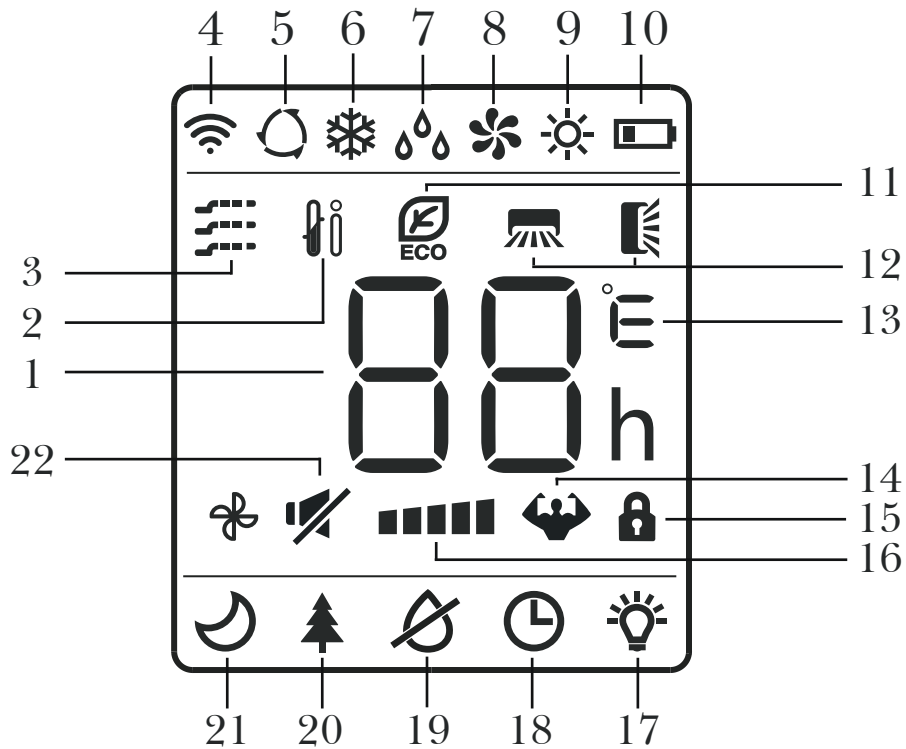

No.	Icon	Description
1	8.8	Temperature Indicator
2	Person icon	I Feel/Follow Me Mode
3	Wind icon	Gentle Wind (Some Models)
4	Signal icon	Signal Transmit Indicator
5	Auto icon	Auto Mode
6	Snowflake icon	Cooling Mode
7	Water droplets icon	Dry Mode
8	Fan icon	Fan Only Mode
9	Sun icon	Heating Mode
10	Battery icon	Battery Level Indicator
11	ECO icon	ECO Mode

No.	Icon	Description
12	Directional swing icons	Directional Swing Indicators
13	Temperature unit icon	Unit of Temperature (°C/°F)
14	Turbo mode icon	Turbo Mode
15	Child lock icon	Child Lock Indicator
16	Fan speed icon	Fan Speed (Auto or Fixed)
17	LED display icon	LED Display On/Off
18	Timer icon	Timer Active Indicator
19	Anti-mildew icon	Anti-Mildew (Some Models)
20	Health function icon	Health Funct. (Some Models)
21	Sleep function icon	Sleep Function
22	Mute function icon	Mute Function

NOTE ON ILLUSTRATIONS

The illustrations in this manual are strictly for explanatory purposes. The actual display and some functions of the remote controller may vary according to the model purchased.

Operating Instructions

4

Replacement of Batteries

Remove the battery cover from the rear of the remote controller, by sliding it downward in the direction of the arrow as depicted below. Install batteries according to the depicted directions (+ and -) as shown on the remote controller. The cover then slides back into place.

 Use 2x AAA batteries. Do not use re-chargeable batteries. Replace old batteries with new ones of the same type when the display is no longer legible. Do not dispose of batteries as unsorted municipal waste. Disposal of such waste separately for special treatment is necessary. If the system will not be used for a long time, remove batteries to prevent leakage.

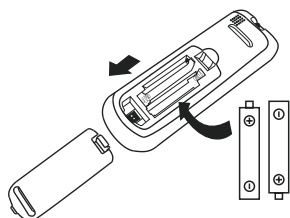

Note
Please remove batteries to avoid leakage damage when not being used for a long time.

Configuring Remote Controller Settings (some models)

Depending on the system, the control type (Cooling Only or Heat Pump) and the unit of Temperature (°C or °F) can be configured using the manual dip-switches below the battery compartment. Operate as below:

Switch Position	Functional Result
°C	Temp. Units are Celsius
°F	Temp. Units are Fahrenheit
COOL	Cooling Only Operation
HEAT	Heating + Cooling Operation

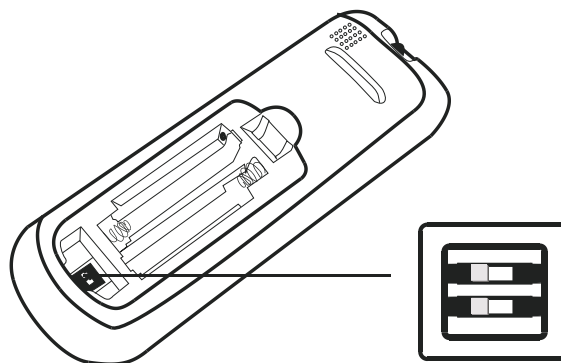

Operating the Remote Controller Successfully and Safely

- Ensure no objects come between the remote controller and signal receptor of indoor unit.
- Keep the remote at least 3 ft away from televisions and other electrical appliances.
- Always direct the remote controller toward the air conditioner.
- Don't leave the remote exposed to sunrays.

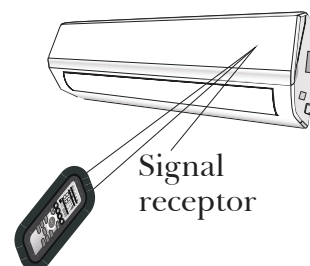

Operating Instructions

4

Regarding the Airflow of the Indoor Unit

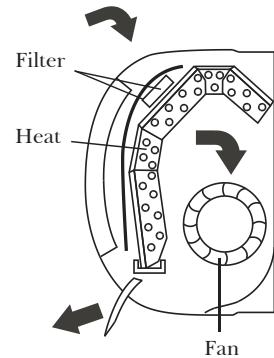

The air that is pulled in by the fan (the “return air”) enters the grille and is passed through the filter. It is then cooled/dehumidified/heated through the heat exchanger.

The direction of the air output is manipulated up and down by the motorized louver, and left to right via manually controlled vertical deflectors. Some models may come with “dual-swing” capability, which offers both a horizontal and vertical motorized air flow swing.



Controlling the System's Airflow

1. Pressing the SWING buttons activates the louver.

- Press the Swing  button to trigger the horizontal flaps to swing up and down. Press this button again to stop swing movement at the current angle.
- Press the Swing  button to trigger the vertical flaps to swing left and right. Press this button again to stop swing movement at the current angle.

2. If the vertical deflectors (which are located underneath the flaps) are adjusted manually, they can be used to fix the airflow in a certain vertical position before turning the system on.

Note: Some models possess a self-clean mode which is activated by pressing and holding these two buttons together.

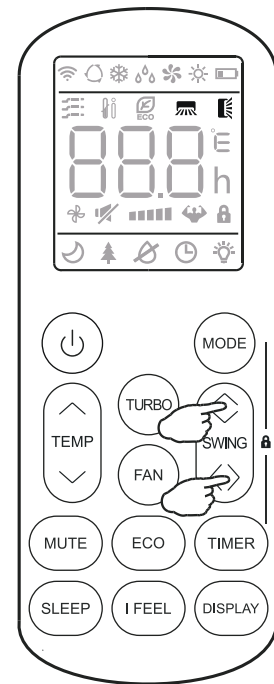

CAUTION

- Do not manipulate the louvers themselves manually, or serious damage may occur.
- Deflector adjustments should be made only when the system is switched off.
- Never poke fingers, sticks, or other objects into the air inlet/outlet vents.

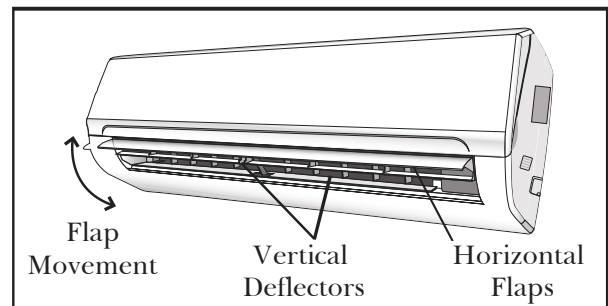





Operating Instructions

4

COOLING Mode

Cooling mode allows the air conditioner to cool the room while also reducing the humidity of the air in the room.



To put the system into cooling mode, press the  button until the  symbol appears on the remote's display.

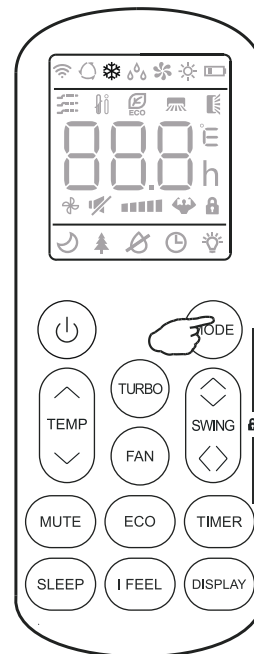

The  and  buttons can then be used to set a temperature lower than that of the room.



HEATING Mode

Heating mode allows the air conditioner to heat the room.

To put the system into heating mode, press the  button until the  symbol appears on the remote's display.

The  and  buttons can then be used to set a temperature higher than that of the room.

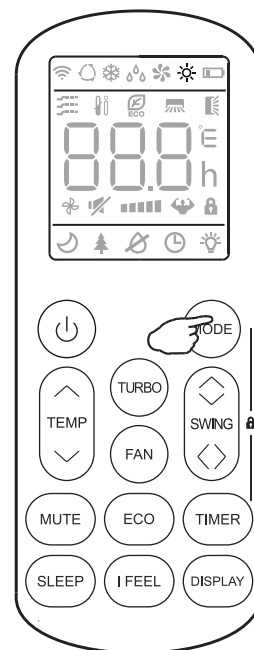

NOTE

In heating mode, the appliance will periodically enter a defrost cycle, which is essential in order to clean frosting off the condenser and recover heat exchange capability. This process is normal and lasts for 2-10 minutes.



During defrosting, the indoor unit's fan will cease operation. After the cycle is completed, the system will resume its normal heat mode operation automatically. Press ECO 10 times within 8 seconds to trigger a forced defrost.

Operating Instructions

4

DRY Mode

Dry mode is a limited function that can rapidly reduce the humidity/moisture of the room.

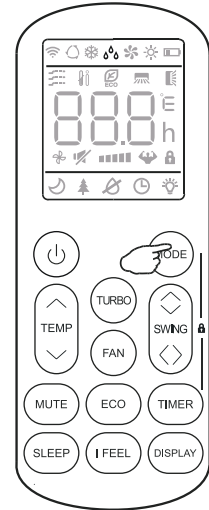

To put the system into dry mode, press the  button until the  symbol appears on the remote's display.

An automatic preset of this mode is then activated.



FAN-ONLY Mode

Fan-only mode is used to set the system to use only air ventilation and no heating or cooling.

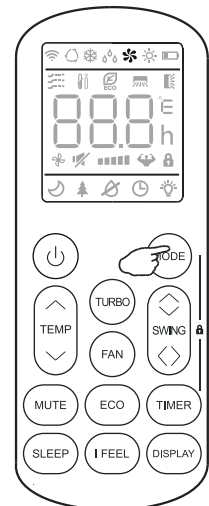

To put the system into fan-only mode, press the  button until the  symbol appears on the remote's display.

Use the  button to then set the desired fan speed.



AUTO Mode

Auto mode will let the system determine the running configuration based on the set temperature and the current room temperature.

To put the system into AUTO mode, press the  button until the  symbol appears on the remote's display.



Operating Instructions

4

Turning the Display On or Off

The LED display on the front panel of the system can be turned on or off as desired.

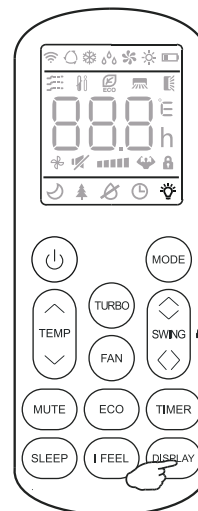

To do so, press the  button in order to switch off the LED display on the front panel. This button can be pressed again to turn the LED display back on.



SLEEP Mode

Sleep mode is generally meant for periods of lower cooling requirements, such as during typical sleeping hours. This mode will result in decreased energy use, and can only be activated via remote control.

After 10 hours in sleep mode, the air conditioner will revert back to the previously set mode.

To put the system into sleep mode, press the  button, and the  symbol will appear on the display. Press this button again to exit from this mode.

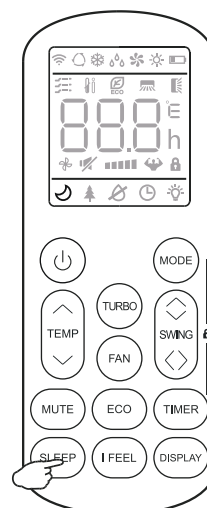

Changing the Fan Speed

The fan speed can be changed between AUTO, LOW, MID, and HIGH speeds.

To do so, press the  button. The running fan speed can then be set. It follows the cycle of:

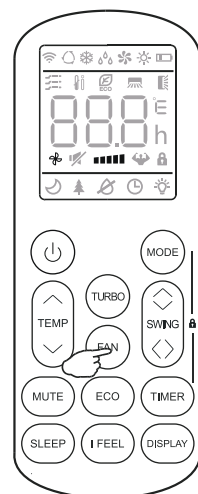
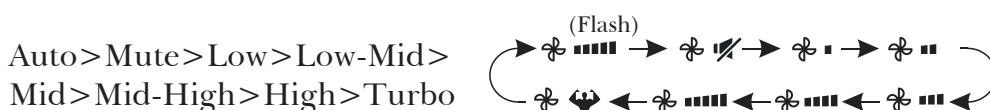



Operating Instructions

4

Energy Saver (ECO) Option

In this mode, the appliance will automatically manage the operation in order to save energy.



To turn the ECO feature on, press the  button on the remote, and the  icon will appear. The system is now running in ECO, and the process can be repeated to turn it off.

NOTE





The ECO feature is available in both COOLING and HEATING modes.

TURBO Option

In this mode, the appliance will operate using the highest fan speed in order to maximize output and reach the set temperature the quickest.

To turn the TURBO feature on, press the  button on the remote, and the  icon will appear. The system is now running in TURBO, and the process can be repeated to turn it off.

Child-Lock Function

Pressing  and  buttons together will activate the child-lock function. When this function is active, the  icon will be displayed, and no single button will be active. Press the  and  buttons together once more to de-activate the child-lock function.

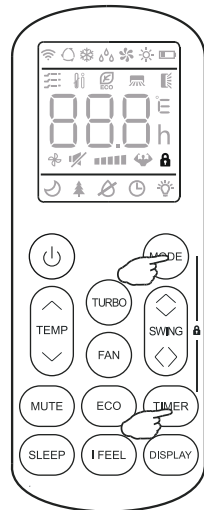
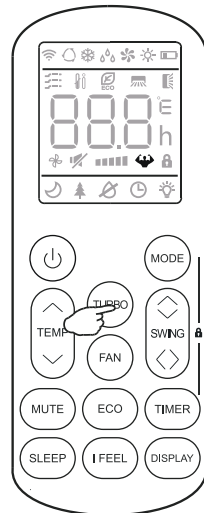
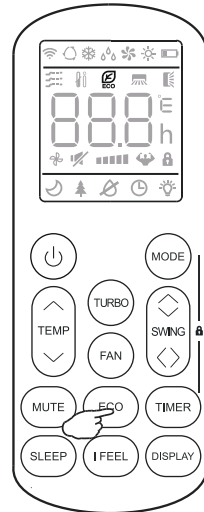









Operating Instructions

4

Using the Timer - TIMER ON

The TIMER feature allows you to set a time delay for the system to turn itself on or off.



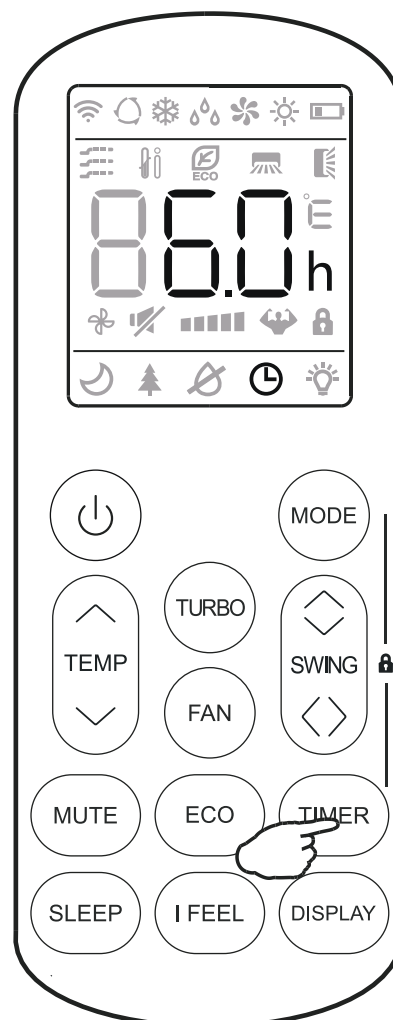

To set a time delay for the system to turn itself on in X amount of hours:

1. Begin by pressing the  button while the system is powered off. The  symbol will then display flashing. The default setting is 6.0 hours.
2. Use the Temp  and  buttons to set the needed time delay in 30 minute increments.
3. Press the  button a second time to confirm.
4. Press the  button to select the desired operating mode that the unit should start up in.
5. Set the desired fan speed that the unit should start up in by pressing the  button.
6. Use the  and  buttons to set the desired operation temperature. The unit is now primed.



Using the Timer - TIMER OFF

The TIMER OFF feature allows the appliance to turn itself off after X amount of hours have passed. The symbol  will appear. To set a time delay for the system to turn itself off in X amount of hours:

1. Confirm that the appliance is on and running.
2. Press the  button to enter the prompt for switching off the system. Use the  and  buttons to configure the time delay setting.
3. Press the  button again to confirm. It can also be pressed once more to cancel the setting.

NOTE Regarding Timers

- Press the  button to cancel at any time in Timer Off.
- The programming will cancel if no buttons are pressed after 5 seconds. This may require restarting the process.

Operating Instructions

4

46°F Freeze Protection Function

This feature is meant to be used to prevent freezing while the user is away from home. When turned on, it sets the system to keep a temperature of 46°F. If the unit is in standby, then the setting will automatically start the heating mode when the room temperature is equal to or lower than 46°F. It will set the system back to standby when the room temperature reaches 48°F.

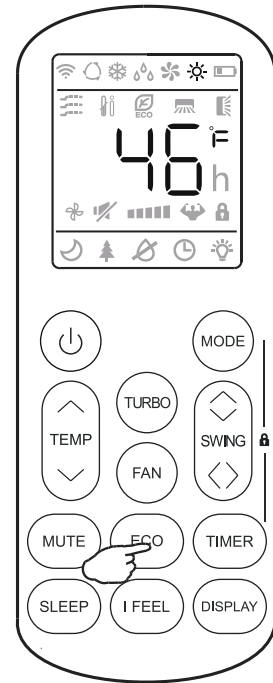

If the room temperature is ever 64°F or higher, then the appliance will cancel or prevent this feature automatically.

Press and hold the  button for 3 seconds to activate this feature. Repeat this to de-activate.





MUTE Mode

When the system is muted, the remote controller will display AUTO fan speed, and the indoor unit will operate at its lowest fan speed in order to minimize operation noise.

Press the  button in order to activate this mode. The  icon will display to indicate that the system is muted.

This mode can be cancelled by pressing either the FAN, TURBO, or SLEEP buttons.

Note: The MUTE feature cannot be activated when the system is in DRY mode.

Note: Some models come equipped with a “Gentle Wind” function, where the unit will auto-close the vertical louver, and provide a softer air breeze. Activate this by pressing the  and  buttons together for 3 seconds.

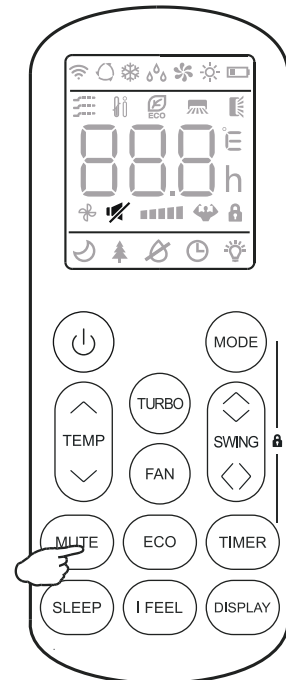



Operating Instructions

4

I FEEL - To Ensure Comfort



The I FEEL feature enables the remote to act as the temperature sensor and relay the current air temperature of where the remote is physically placed within the room. In some cases, this can aid with reducing thermal drift between the set temperature and the actual room temperature.

In order to activate this feature, press the  button, and the  icon will appear on the display.

Note: The I FEEL feature will automatically de-activate itself 2 hours later.

SELF-CLEAN Feature

This feature helps carry away accumulated dust, dirt, bacteria, and other microbial contents away from the indoor evaporator.

To activate this feature, press the Swing  and  buttons together until a beep is heard from the unit, and AC is displayed on the unit and remote. This procedure will run for approximately 30 minutes, before returning to the preset mode.

The  button can be pressed to cancel this feature during the process. Two beeps will be emitted from the machine when it is finished, or cancelled.

This procedure can result in some uncommon noise coming from the machine. This noise is normal as a side effect of the plastics expanding and contracting due to reactions with heat and cold.

It is recommended to use this function only when indoor temperature is under 86°F and outside temperature is between 41°F and 86°F.

It is suggested to run this feature once every 3 months.

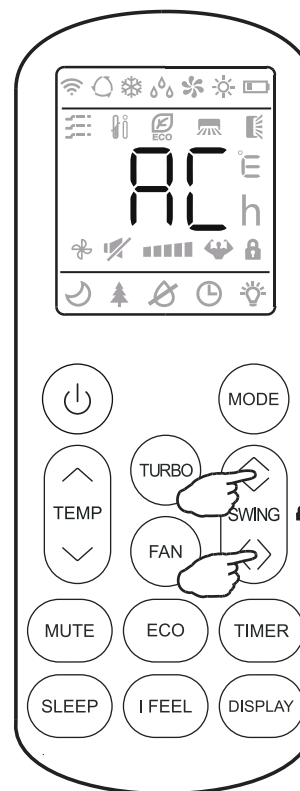
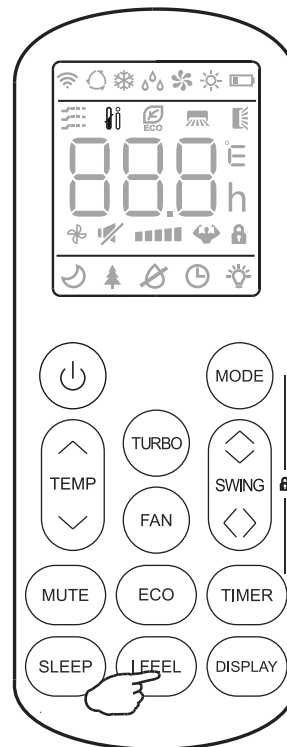

Operating Instructions

4

An Important Note Regarding Operating Temperatures

The system is designed to run within a certain range of temperatures, which are listed below. There are built-in protections with the system that may stop the appliance when the ambient temperatures goes outside of these ranges.

Inverter Air Conditioner

Temperature \ Operating Mode	COOLING Mode	HEATING Mode	DRYING Mode
Current Room Temperature	63°F - 89°F	32°F - 86°F	63°F - 89°F
Ambient Outdoor Temperature	5°F - 127°F	-13°F - 86°F	59°F - 127°F

NOTE

After stopping and restarting the air conditioner, or after the mode is changed during operation, the system does not restart immediately, and will come on when three minutes have elapsed (as a protection for the compressor).

Full system-rated capacity and efficiency is obtained at the standard rating conditions as developed by the testing and rating agencies. Deviations from the rating conditions, especially the atmospheric conditions, will be compensated by the variable speed compressor, within certain limitations.

Heat pump systems function by exchanging energy, in the form of heat, between the indoor air and the outdoor ambient air (atmospheric). The system's net cooling or heating capacities and efficiencies change by atmospheric conditions, as well as the indoor air conditions (such as temperatures and humidity levels).

Capacity of the system required for a specific area or application must be determined professionally using detailed calculations, which are based on several internal and external factors.

To further optimize the performance of your unit, be sure to do the following:

- Keep doors and windows closed.
- Limit energy usage by using TIMER ON and TIMER OFF functions.
- Do not block air inlets or outlets.
- Regularly inspect and clean air filters.

Maintenance of the Air Conditioner

5

Periodic Maintenance Is Essential For The System!

Maintaining the air conditioner will ensure that it stays efficient. Before carrying out any sort of maintenance, always ensure that the power supply to the system is turned off.

Indoor Unit

Anti-Dust Filters (Clean once every 2 weeks)

1. Open the front panel by pulling outward and upward at the indicated location.
2. Keep the front panel raised with one hand and take out the air filters with the other.
3. The filters are washable and should be cleaned with warm water (under 113°F).
4. Leave the filters to dry in a cool, dry place.
5. Keeping the front panel raised with one hand, insert the air filters with the other.
6. Close the front panel.

Any electrostatic or deodorizing filters, if installed, are not washable and should be replaced once every 6 months.

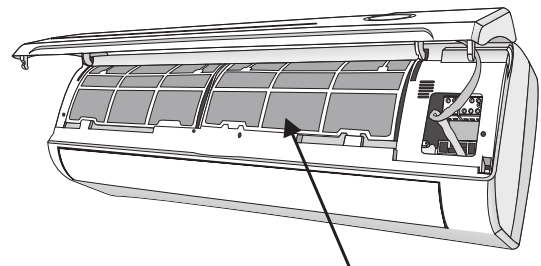
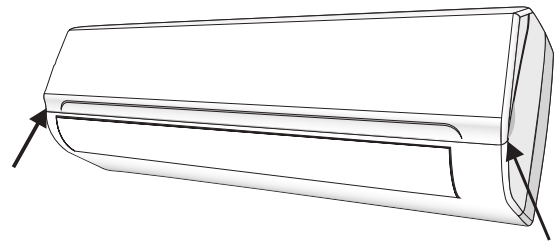

Anti-Dust Filter

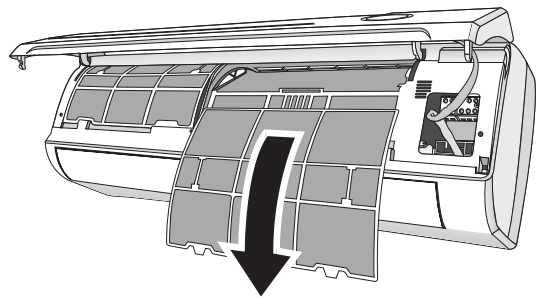

Interior of the Indoor Air Handler

In addition to the filters, the interior of the indoor unit itself as well as the inner coil should be inspected every season. The front panel can be disconnected and removed from the top hinge where the pegs connect. This will allow for easier inspection of the interior and behind the air filters. The interior should be cleaned with damp cloth and neutral soaps. Do not use any sort of aggressive solvents or detergents. Only a soft cloth that is lightly damp should be used.

⚠ BEFORE CLEANING OR MAINTENANCE

ALWAYS TURN OFF YOUR AIR CONDITIONER SYSTEM AND DISCONNECT ITS POWER SUPPLY BEFORE PERFORMING CLEANING OR MAINTENANCE. DO NOT SPRAY WATER DIRECTLY NEAR THE INDOOR UNIT, AS IT CAN DAMAGE INSULATION AND ELECTRICAL COMPONENTS.

Indoor Unit Installation Instructions

6

Indoor Unit Installation Location Selection

Follow the below best practices for selecting an optimal space for installation the indoor unit:

- **DO NOT** install the unit on a wall that is subject to vibrations.
- **DO NOT** install the system near sources of heat, steam, or flammable gases.
- **DO NOT** install the indoor unit in a location that is exposed to direct sunlight.
- **DO** ensure that the inlet and outlet vents are not obstructed. The system should be able to output air all across the room.
- **DO** minimize the distance between the indoor and outdoor unit and install the unit in a place where connecting the indoor and outdoor unit will be as simple as possible.
- **DO** install the unit on a strong wall and where it is easy to drain the condensate water.
- **DO** install the unit in a location where it will be easy to service the machine and perform any necessary maintenance.
- **DO** obey the following tolerances depicted in the illustration below:

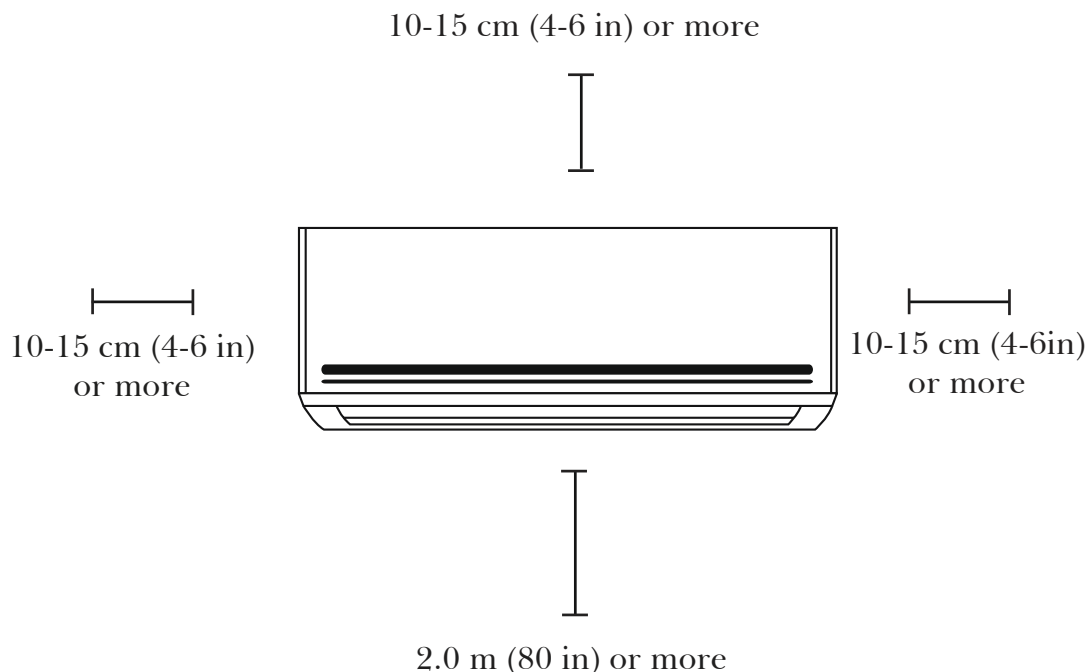

Indoor Unit Installation Instructions

6

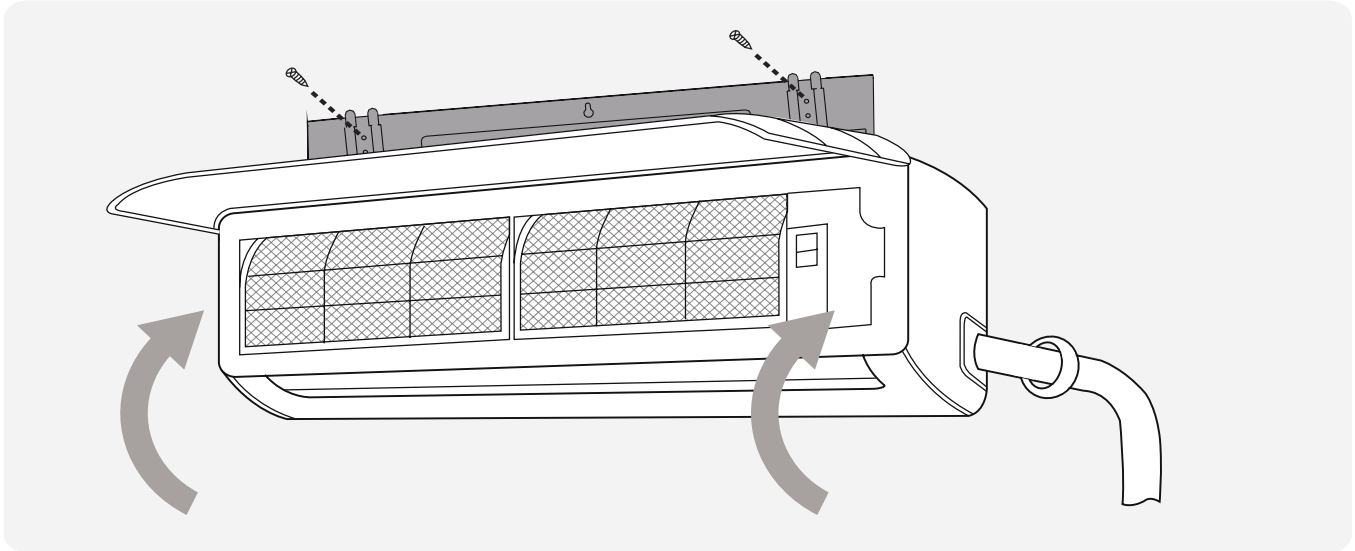

Installation Diagram

Before proceeding, it is important to consider the following height and length restrictions:

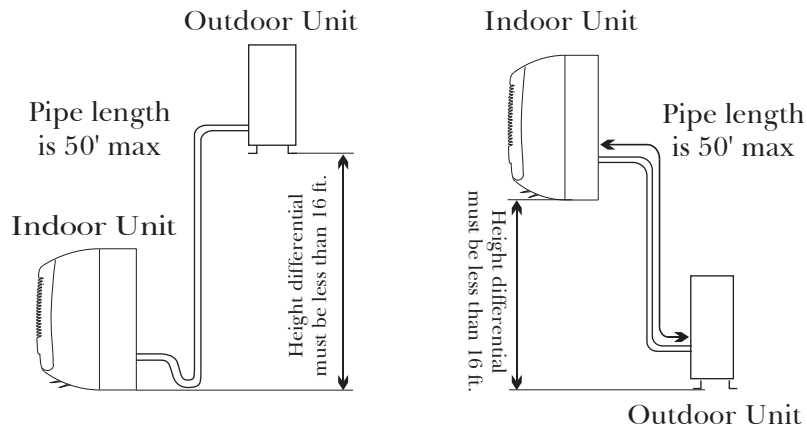

Before starting the installation, decide on the position of both the indoor and outdoor units. Take into account the minimum clearance requirements for both the indoor and outdoor units, which can be found in their respective sections of this manual.

Install the indoor unit inside the room to be air conditioned, avoiding corridors and communal areas. Install the indoor unit at a height of at least 8 ft. off of the ground.

NOTE

Only persons and/or companies qualified and experienced in the installation, service, and repair of refrigerant products should be permitted to do so. The purchaser must ensure the system is installed carefully and correctly.

Indoor Unit Installation Instructions

6

Installation of the Mounting Plate

1. Place the included mounting plate against the wall where the system will hang that fulfills the constraints on page 22. Use a level to ensure that the plate is horizontally level.
2. Drill 1.3" deep holes for each screw to enter, the locations are flexible but should be spaced well.
3. Insert the plastic anchors into each of the holes.
4. Fix the mounting plate to the wall by using the included tapping screws. Check that it is secured.

Note: The actual appearance of the mounting plate may differ slightly but the process is similar.

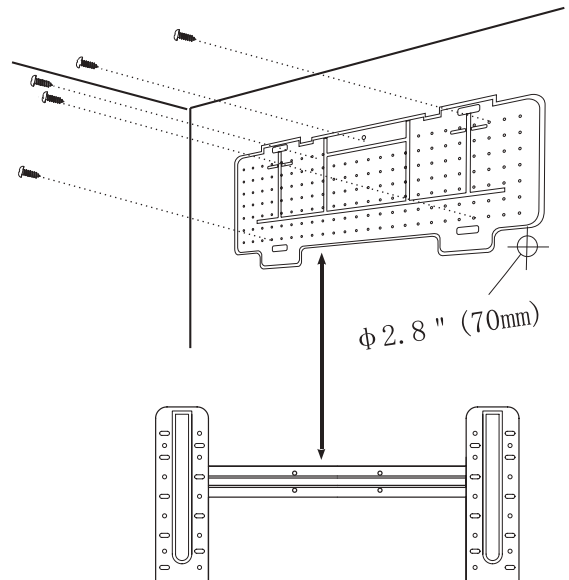

Drilling the Wall Hole for Piping

CHECK PAGES 43-44 FOR MOUNTING HOLE GUIDELINES ACCORDING TO THE BRACKET.

1. With the mounting plate firmly affixed to the wall, mount the indoor unit onto the mounting plate temporarily in order to determine the location of the wall hole in the next steps.
2. Using a pencil, lightly trace the bottom corner of the indoor unit, depending on which side exit the piping will go through (see Page 26).
3. Take the inside unit off of the plate, and make a mark of where the hole will be (PG. 43-44), to ensure ample clearance between the tracing and bracket.
4. Drill a 2.5" wall hole at a slight downward angle using a core drill, being careful to avoid wires, plumbing, and other sensitive materials. The bottom of the inside hole should be $\sim 1/4''$ above the bottom of the outside hole.

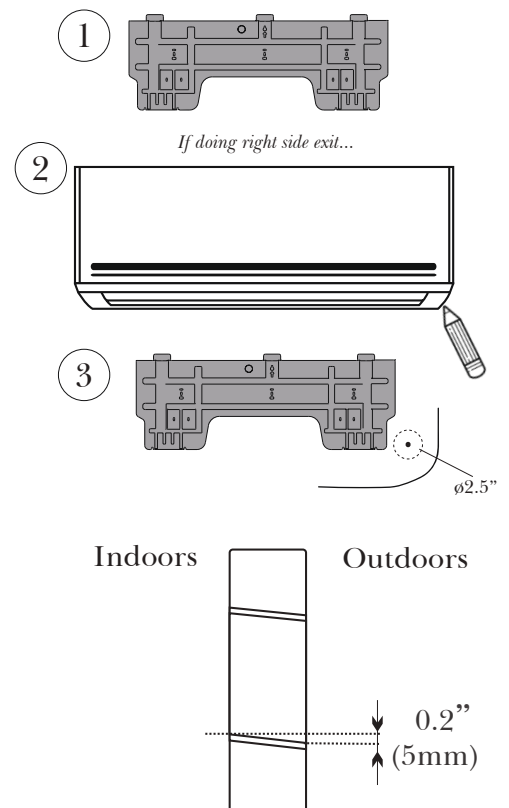

Indoor Unit Installation Instructions

6

Electrical Connections - Indoor Unit

All systems will include a wiring diagram affixed to the indoor unit. See **Page 44** for more details.

1. Lift up the front panel of the indoor unit.
2. Remove the cover as indicated in the illustration.
3. For the electrical wiring, consult the circuit diagram affixed to the electrical cover.
4. Connect the cables to the wiring terminal by following the numbering. Use wire gauge suitable for the electrical power input. (see name plate on the unit).

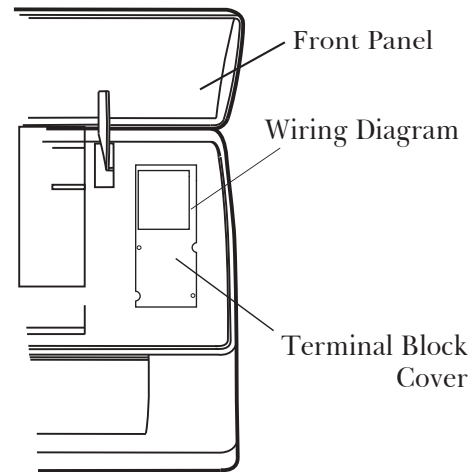

BEFORE PERFORMING ELECTRICAL WORK, READ THESE REGULATIONS

1. All wiring must comply with local and national electrical codes, and must be installed by a licensed electrician.
2. All electrical connections must be made according to the Electrical Connection Diagram located on the panels of the indoor and outdoor units.
3. If there is a serious safety issue with the power supply, stop work immediately. Explain your reasoning to the client, and suspend all installation until the safety issue is properly resolved.
4. Power voltage should be within 90-110% of rated voltage. Insufficient power supply can cause malfunction, electrical shock, or fire.
5. Connect power through fixed wiring, install a surge protector and a disconnect switch box, and a dedicated circuit breaker with a capacity of 1.5 times the maximum current of the unit.
6. A properly rated HACR-type fuse or circuit breaker that disconnects all poles and has a contact separation of at least 1/8in (3mm) must be incorporated in the fixed wiring. The qualified technician must use an approved circuit breaker or fuse.
7. Only connect the unit to an individual branch circuit. Do not connect another appliance to that outlet. This equipment requires its own dedicated and protected circuit.
8. Make sure to properly ground the air conditioner.
9. Every wire must be firmly connected. Loose wiring can cause the terminal to overheat, resulting in product malfunction and possible fire.
10. Do not let wires touch or rest against refrigerant tubing, the compressor, or any moving parts within the unit.



WARNING:

**BEFORE PERFORMING ANY ELECTRICAL OR WIRING WORK,
TURN OFF THE MAIN POWER TO THE SYSTEM.**

Indoor Unit Installation Instructions

6

Preparing the Refrigerant Piping of the Indoor Unit

The piping “pigtailed” pre-attached to the indoor unit can be run in 3 different ways as shown in the illustration. Decide which type of configuration is most suitable before continuing.

By default it is routed for a left side exit as shown in #1. This method can either use the left side knockout for a side exit, or a wall hole can be drilled on the left side of the unit’s rear.

Routing it straight through the back of the system (#2) will facilitate the connections to the copper pipe extensions to be made outside. This is recommended to simplify the process.

#3 is a right side exit, but is not recommended as it involves a 180° bend of the piping, which increases the risk of kinking or collapsing the lines dramatically. Bend slowly and cautiously.

If a side-exit is chosen, there are knock-out panels on either side of the unit that can be cut out along the groove to provide a notch for the pipe to exit from. Use a cutter to do this.

For the method chosen, run the piping in the direction of the wall hole. Bind the copper pipes, drain pipe, and power cables together with tape, with the drain pipe at the bottom so that water can flow freely. **Ensure that the bundle is exiting at a continuous downward pitch.**

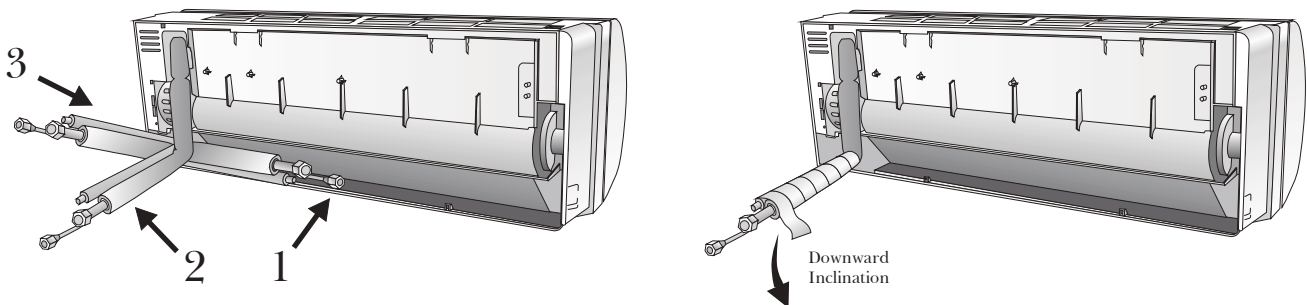

! CAUTION

- Do not remove the cap from the pipe until it is time to connect it, to avoid dampness or dirt from entering.
- If the pipe is bent/pulled too often, it will become stiff. Do not bend the pipe more than three times at one point. **Be extremely careful not to kink any piping.**
- When extending the coiled copper pipes, straighten them by unwinding gently, as shown in the picture.

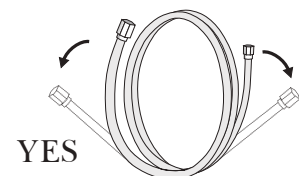
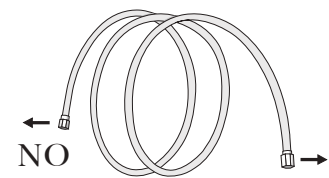

Unwind the coil gently rather than pulling at ends

Indoor Unit Installation Instructions

6

Connecting the Drain Hose

By default, the drain hose is attached to the left-hand side of unit ("left" when facing the back of the unit). However, it can also be attached to the right-hand side.

1. To ensure proper drainage, attach the drain hose on the same side that your refrigerant piping exits the unit.
2. Attach any drain hose extensions (sold separately) to the end of drain hose.
3. Wrap the connection point firmly with Teflon tape to create a good seal, and to prevent leaks.
4. For the portion of the drain hose that will remain indoors, wrap it with foam pipe insulation to prevent condensation.
5. Remove the air filter and pour a small amount of water into the drain pan to make sure that water flows from the unit smoothly.

NOTE ON DRAIN HOSE PLACEMENT

Make sure to arrange the drain hose according to the illustrations.

- ⊘ **DO NOT** kink the drain hose.
- ⊘ **DO NOT** create a water trap (siphon).
- ⊘ **DO NOT** put the end of the drain hose in water or in a container that will collect water.

DUAL DRAIN HOLE LOCATIONS EXIST

The indoor unit has 2 drain connections on left and right sides. Either one can be utilized. One side will have a hose connected, while the other is plugged.

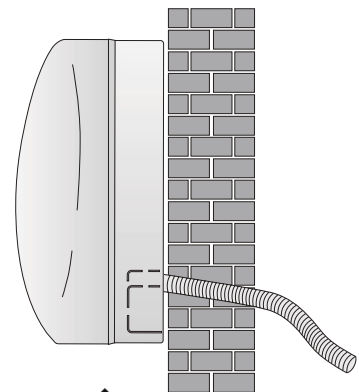

YES

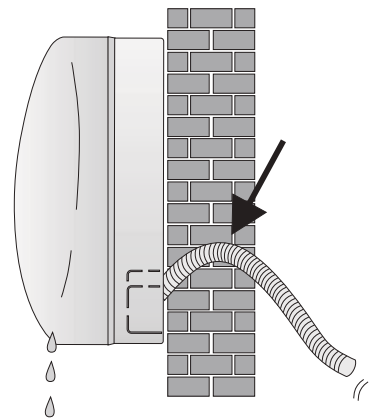

NO

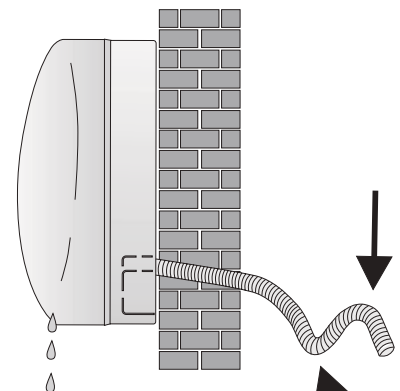

NO

Indoor Unit Installation Instructions

6

Connecting the Signal Cable

Color selection does not matter as much as matching number to number does. Consult the diagram affixed to the indoor and outdoor unit respectively for specific wiring instructions. There are 3 terminals (1, 2, 3) and ground (G). Do not mix up the wires between each ends. **It is vital** that the colors between the indoor and outdoor unit match for each terminal. A simplified wiring diagram is included in the Appendix section of the On the indoor unit, the wiring diagram is located underneath the front panel as shown below:

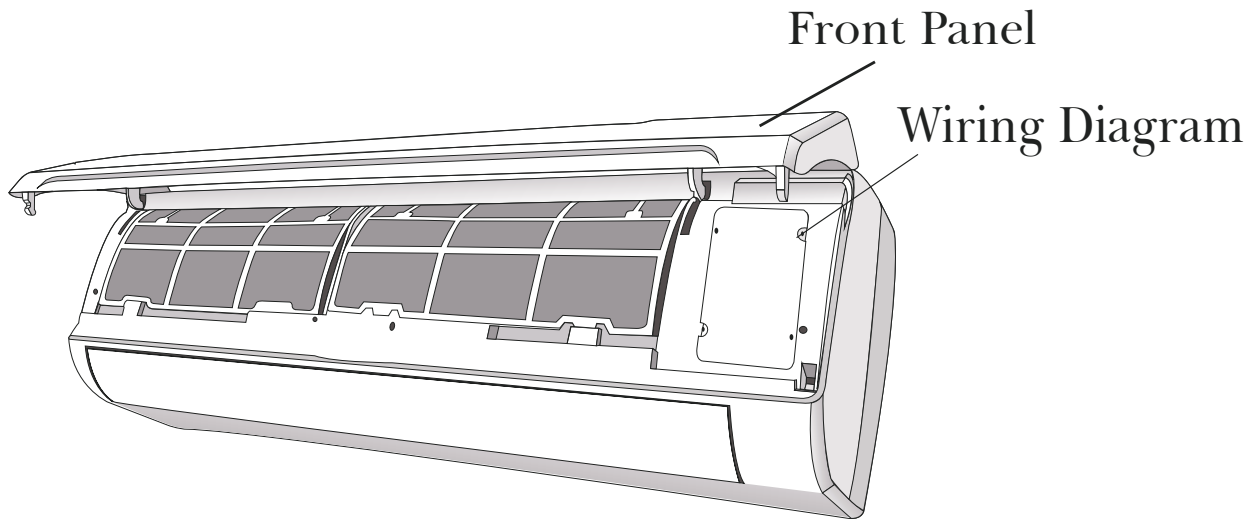

Cable Wire Specifications (For Uncommon Configurations)

Pioneer WYT Series Mini Split		9K/115V	12K/115V	9K/230V	12K/230V	18K	24K	36K
		Sectional Area (AWG)						
Power Supply Cable	N(L2)	12AWG	12AWG	12AWG	12AWG	12AWG	12AWG	10AWG
	L(L1)	12AWG	12AWG	12AWG	12AWG	12AWG	12AWG	10AWG
	⊕	12AWG	12AWG	12AWG	12AWG	12AWG	12AWG	10AWG
Connection Supply Cable	3(L)	16AWG	16AWG	16AWG	16AWG	16AWG	16AWG	16AWG
	2(N)							
	1(S)							
	⊕							

Consult the nameplate on the system for detailed electrical specifications. Confirm wire size on **Page 32**.

Indoor Unit Installation Instructions

6

Connecting the Refrigerant Piping to the Indoor Unit

Once the copper piping kit coil is unwound, refer to the below instructions to proceed:

1. Bring the ends of both the copper line and the indoor unit line together. Align the centers of the pipes that will be connected.
2. Remove the indoor unit piping cap, and check that no debris is inside. Some gas may be heard escaping, it is just nitrogen.
3. Use any leak guard or leak sealant on the flares of the piping if available. Attach the flare nut and tighten as much as possible by hand. Torque correctly to the specifications found on the next page using two wrenches. Repeat the process for the other copper line.

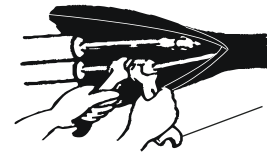
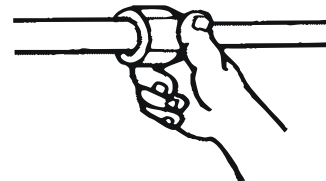

Torque Wrench

TIGHTENING TORQUE FOR PROTECTION CAPS AND FLANGE CONNECTION

PIPE	TIGHTENING TORQUE [N x m]	CORRESPONDING STRESS (using a 20 cm wrench)	TIGHTENING TORQUE [N x m]	
1/4" (φ6.35)	15 - 20	Wrist Strength	Service Port Nut	7 - 9
3/8" (φ9.52)	31 - 35	Arm Strength	Protection Caps	25 - 30
1/2" (φ12.7)	35 - 45	Arm Strength		
5/8" (φ16)	75 - 80	Arm Strength		

Wrapping the Lines and Mounting the Indoor Unit

For mounting the indoor unit, proceed as follows:

1. Arrange the pipes, cables, and drain hose well.
2. Lag the pipe joints with insulation material, and secure with vinyl tape as depicted in the figure.
3. Run the bound bundle through the wall hole, and mount the indoor unit securely onto the mounting plate. Press/push the lower part of the indoor unit so it clicks onto the mounting plate.

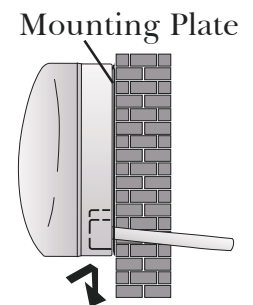
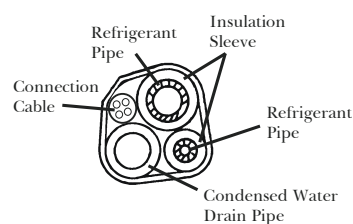
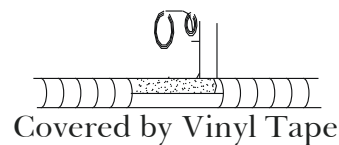

Outdoor Unit Installation Instructions

7

Outdoor Unit Installation Location Selection

Follow the below best practices for selecting an optimal space for installation the indoor unit:

- **DO NOT** install the unit near sources of heat, steam, or flammable gases.
- **DO NOT** install the system in areas prone to extreme winds or dust.
- **DO NOT** install the outdoor unit in an area that has many passersby.
- **DO** select a location where the air discharge and operating sound level will not disturb others.
- **DO** install the system in a shaded area or utilize a cover/sun protection that will not interfere with air flow. This will also protect the system from rain or snow.
- **DO** install the unit in a safe and sturdy location.
- **DO** install rubber vibration absorbers if the system will be subject to vibrations.
- **DO** obey the following tolerances depicted in the illustration below to ensure air flow:

Minimum Required Installation Space

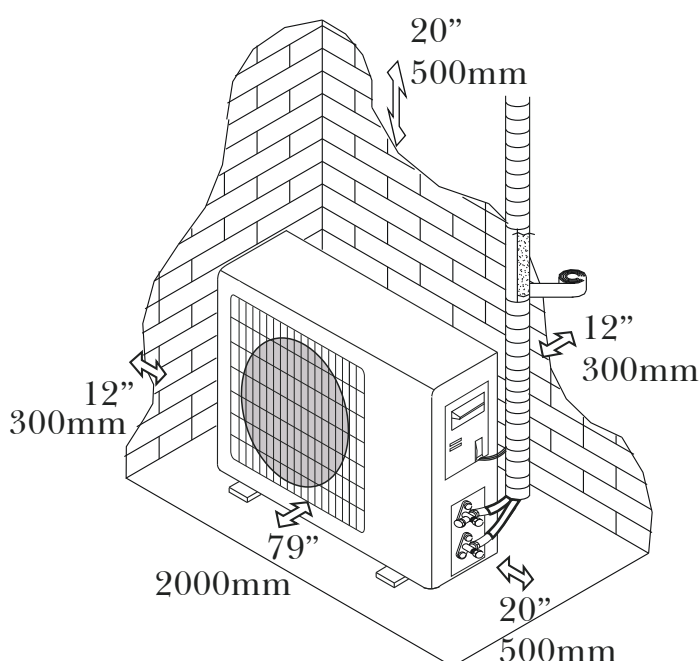

SPECIAL CONSIDERATIONS FOR EXTREME WEATHER CONDITIONS

If the unit is exposed to heavy wind: Install unit so that air outlet fan is at a 90° angle to the direction of the wind. If needed, build a barrier in front of the unit to protect it from extremely heavy winds.

If the unit is frequently exposed to heavy rain or snow: Build a shelter above the unit to protect it from the rain or snow. Be careful not to obstruct air flow around the unit. If the unit is frequently exposed to salty air (seaside air): Use specifically approved anti-corrosion coating sprays onto the heat exchanger surface in order to resist corrosion.

Outdoor Unit Installation Instructions

7

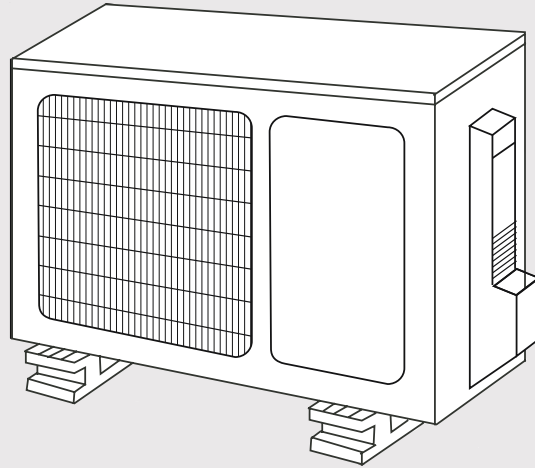

Mounting the Outdoor Unit to the Selected Location

The outdoor unit should be installed either on a pad or on a solid wall and fastened securely. Follow the procedure below before connecting any pipes or cables:

- Decide what the best position on the wall or on the ground is, and leave enough space to be able to carry out maintenance easily. Anchoring dimensions are provided on **Page 42**.
- If wall mounting, fasten the support brackets to the wall using hardware that is particularly suited for the type of wall. Use the appropriate amount of hardware for the application.
- The unit must be installed following all national regulations.

Outdoor Unit Condensate Water Drainage

The condensate water and the ice formed in the outdoor unit during heat mode can be directed away using the optional drain pipe included with the system.

1. Fasten the drain port in the 1 inch port located in the part of the unit depicted in the diagram.
2. Connect the drain port and the drain pipe.
3. Ensure the condensate will drain to a suitable place.

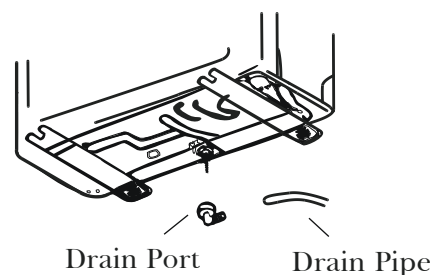

Outdoor Unit Installation Instructions

7

BEFORE PERFORMING ANY ELECTRICAL WORK, READ THESE REGULATIONS

1. All wiring must comply with local and national electrical codes, and must be installed by a fully-licensed electrician.
2. All electrical connections must be made according to the Electrical Connection Diagram located on the side panels of the indoor and outdoor units.
3. If there is a serious safety issue with the power supply, stop work immediately. Explain your reasoning to the client, and suspend all installation of the unit until the safety issue is properly resolved.
4. Power voltage should be within 90-110% of rated voltage. Insufficient power supply can cause electrical shock or fire.
5. Connect power through fixed wiring, install a surge protector, and disconnect switch box. Use a dedicated circuit breaker with a capacity of 1.5 times the maximum current of the unit.
6. A properly rated HACR-type fuse or circuit breaker that disconnects all poles and has a contact separation of at least 1/8in (3mm) must be incorporated in the fixed wiring. The qualified technician must use an approved circuit breaker or switch.
7. Only connect the unit to a dedicated individual branch circuit breaker. Do not connect another appliance to that same circuit.
8. Be sure to properly ground the air conditioner.
9. Every wire must be firmly connected. Loose wiring can cause the terminal to overheat, resulting in product malfunction and possible fire.
10. Do not let wires touch or rest against refrigerant tubing, the compressor, or any other moving parts within the unit.

WARNING

BEFORE PERFORMING ANY ELECTRICAL OR WIRING WORK, TURN OFF THE MAIN POWER TO THE SYSTEM.

1. Prepare the cable for connection:

USE THE RIGHT CABLE

- Outdoor Power Cable: H07RN-F
- Signal Cable: H07RN-F

Minimum Cross-Sectional Area of Power and Signal Cables North America

Appliance Amps (A)	AWG
10	18
13	16
15	14
20	12
30	10

INDOOR UNIT TERMINAL POSITION #1 connects to OUTDOOR UNIT TERMINAL POSITION #1.

INDOOR UNIT TERMINAL POSITION #2 connects to OUTDOOR UNIT TERMINAL POSITION #2.

INDOOR UNIT TERMINAL POSITION #3 connects to OUTDOOR UNIT TERMINAL POSITION #3.

INDOOR UNIT TERMINAL POSITION "GROUND" connects to OUTDOOR UNIT GROUNDING LUG

Using wire strippers, strip the rubber jacket from both ends of cable to reveal about 40mm (1.5 in) of the wires inside. Strip the insulation from the ends of the wires. Using a wire crimper, crimp u-lugs on the ends of the wires. Note that some cables come with preinstalled u-lugs from factory.

Outdoor Unit Installation Instructions

7

Power/Signal Electrical Wiring to the Outdoor Unit

On the outdoor unit, the wiring diagram is located in the inner side of the handle cover.

The outside unit's terminal block is protected by an electrical wiring cover on the side of the unit. A comprehensive wiring diagram is printed on the inside of the wiring cover.

1. Unscrew and remove the handle on the right side plate of the outdoor unit.
2. Wire the system using the appropriate gauge wire found on page 29/32 and the wiring diagram found on the handle cover. See page 43 for more details.
3. Fasten the power connection wires into place using the supplied wire clamps.
4. Check the wiring against the diagram to ensure it is wired correctly. A proper ground must be established.
5. Rescrew and reinstall the cover handle.

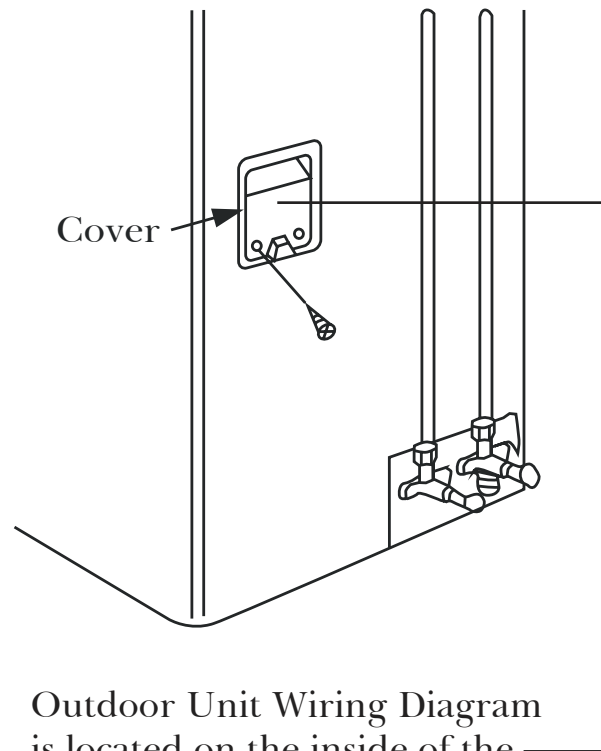

Outdoor Unit Wiring Diagram is located on the inside of the wire cover on the outdoor unit.

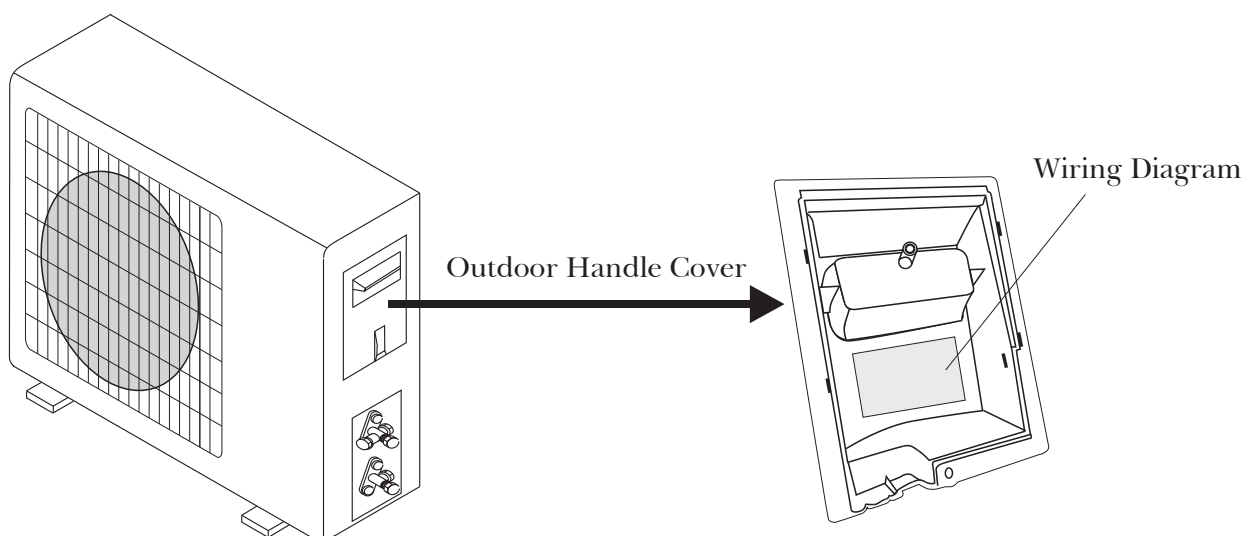

Outdoor Unit Installation Instructions

7

Connection of the Refrigerant Piping

The length of refrigerant piping will affect the performance and energy efficiency of the unit. Nominal efficiency is tested on units with a pipe length of 5 meters (16 ft). Refer to the table below for specifications on the maximum length and drop height of piping.

Pioneer WYT Series Mini Split MODEL/Capacity (Btu/h)	9K	12K	18K	24K	36K
Liquid Pipe Diameter	1/4" (φ 6.35)	1/4" (φ 6.35)	1/4" (φ 6.35)	1/4" (φ 6.35)	1/4" (φ 6.35)
Gas Pipe Diameter	3/8" (φ 9.52)	3/8" (φ 9.52)	3/8" (φ 9.52)	1/2" (φ 12.7)	5/8" (φ 15.88)
Length of Pipe with Standard Charge	7.5m / 25ft	7.5m / 25ft	7.5m / 25ft	7.5m / 25ft	7.5m / 25ft
Maximum Distance Between Indoor and Outdoor Unit	15m / 49ft	15m / 49ft	15m / 49ft	15m / 49ft	15m / 49ft
Additional Refrigerant Charge (For each add'l foot after 16 ft.)	20g/m 0.22oz/ft	20g/m 0.22oz/ft	20g/m 0.22oz/ft	20g/m 0.22oz/ft	30g/m 0.32oz/ft
Max. Difference in Level Between Indoor and Outdoor Unit	5m / 16ft	5m / 16ft	5m / 16ft	5m / 16ft	5m / 16ft
Type of Refrigerant	R410A	R410A	R410A	R410A	R410A

Outdoor Unit Installation

Connection Instructions – Refrigerant Piping

Step 1: Cut pipes

When preparing refrigerant pipes, take extra care to cut and flare them properly. This will ensure efficient operation and minimize the need for future maintenance.

1. Measure the distance between the indoor and outdoor units.
2. Using a pipe cutter, cut the pipe a little longer than the measured distance.
3. Make sure that the pipe is cut at a perfect 90° angle. Refer below for bad cut examples:

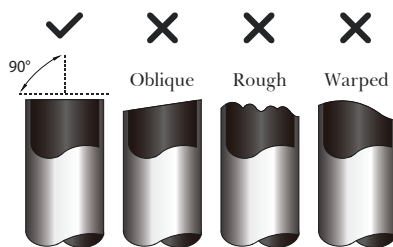

DO NOT DEFORM PIPE WHILE CUTTING

Be extra careful not to damage, kink, or deform the pipe while cutting. This will drastically reduce the efficiency and capacity of the unit and may cause internal damage.

Step 2: Remove any burrs carefully.

Burrs can affect the air-tight seal of refrigerant piping connection. They must be completely removed. Follow these steps for proper deburring:

1. Hold the pipe at a downward angle to prevent burrs from falling into the pipe.
2. Using a reamer or deburring tool, remove all burrs from the cut section of the pipe.

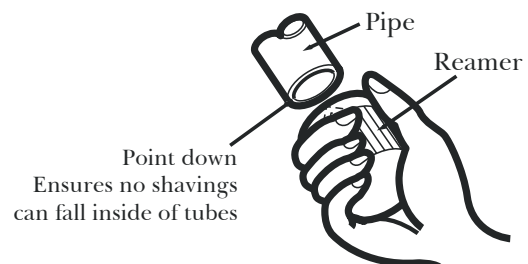

Outdoor Unit Installation Instructions

7

Step 3: Flare pipe ends

Proper flaring is essential to achieve an airtight seal.

1. After removing burrs from cut pipe, seal the ends with PVC tape to prevent foreign materials from entering the pipe.
2. Sheath the pipe with insulating material.
3. Place flare nuts on both ends of pipe. Make sure they are facing the correct direction, because they cannot be put on or have their direction changed after flaring.

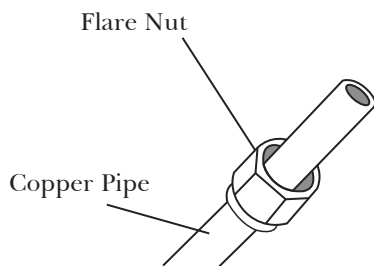

4. Remove PVC tape from ends of pipe when ready to perform flaring work.
5. Clamp flare form on the end of the pipe. The end of the pipe must extend beyond the edge of the flare form in accordance with the dimensions shown in the following table:

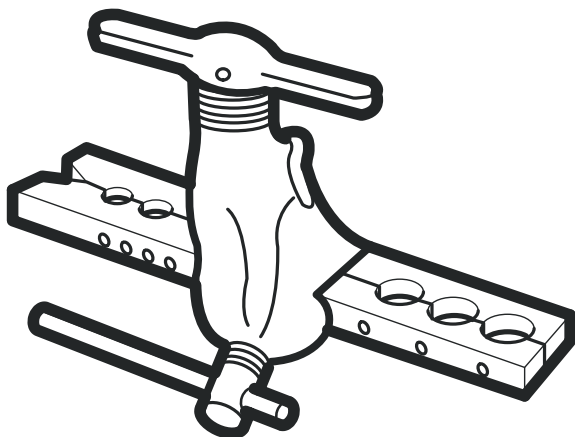

PIPING EXTENSION BEYOND FLARE FORM

Outer Diameter of Pipe (mm)	A (mm)	
	Min.	Max.
Ø 6.35 (Ø 1/4")	0.7 (0.03")	1.3 (0.05")
Ø 9.52 (Ø 3/8")	1.0 (0.04")	1.6 (0.06")
Ø 12.7 (Ø 1/2")	1.0 (0.04")	1.8 (0.07")
Ø 16 (Ø 5/8")	2.0 (0.08")	2.2 (0.09")
Ø 19 (Ø 3/4")	2.0 (0.08")	2.4 (0.1")

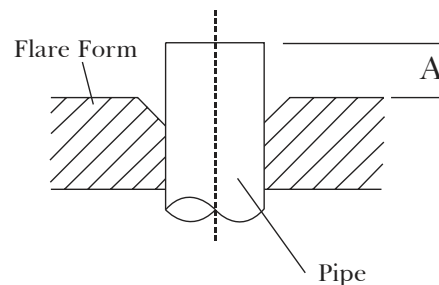

6. Place flaring tool onto the form.
7. Turn the handle of the flaring tool clockwise until the pipe is fully flared.
8. Remove the flaring tool and flare form, then inspect the end of the pipe for cracks and successful, even flaring.

Step 4: Connect pipes

When connecting refrigerant pipes, be careful not to use excessive torque, or to deform the piping in any way. One should first connect the low-pressure pipe, then the high-pressure pipe.

If provided by the supplier, apply leak guard material on all flared mating surfaces.

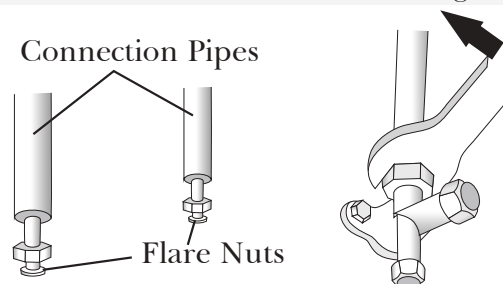

Outdoor Unit Installation Instructions

7

Instructions for Connecting Piping to Outdoor Unit

1. Unscrew the cover from the packed valve on the side of the outdoor unit.

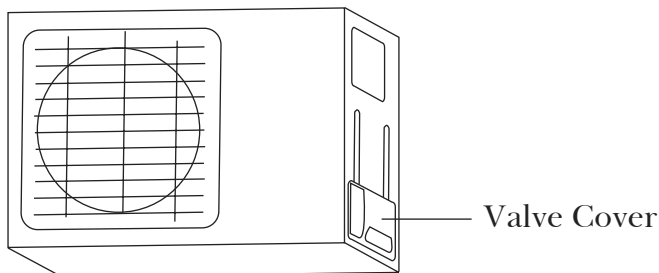

2. Remove protective caps from the valve ends.
3. Align flared pipe end with each valve, and tighten the flare nut as tightly as possible by hand.
4. Using a spanner, grab the body of the valve. Do not grab the nut that seals the service valve.

! USE SPANNER TO GRAB THE BODY OF THE SERVICE VALVE

Torque from tightening the flare nut can snap off other parts of valve.

5. While firmly gripping the body of the valve, use a torque wrench to tighten the flare nut according to the correct torque values.
6. Loosen the flaring nut slightly, then tighten again.
7. Repeat Steps 3 to 6 for the remaining pipe.

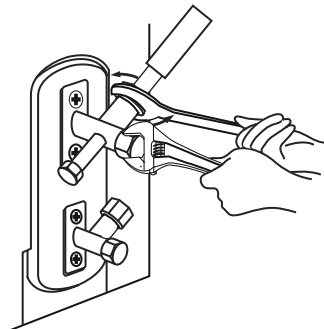

MINIMUM BEND RADIUS

When bending connective refrigerant piping, the minimum bending radius is 10 cm (4").

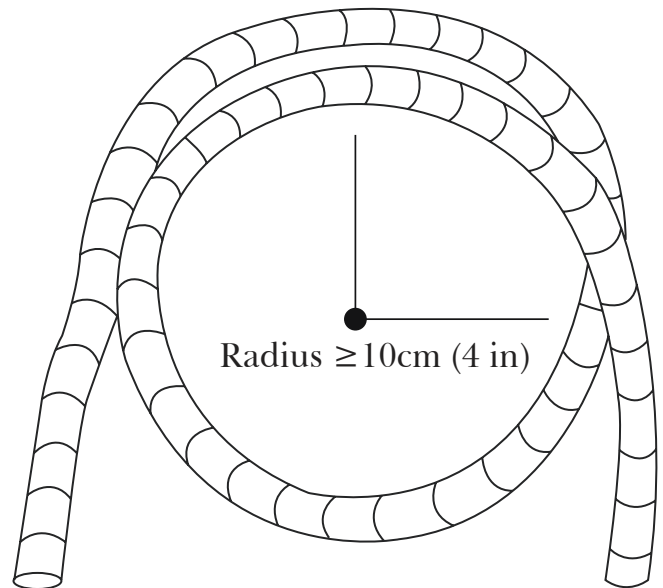

! DO NOT USE EXCESSIVE TORQUE

Excessive force can break the nut or damage the refrigerant piping. You must not exceed the torque requirements shown in the table shown on page 29.

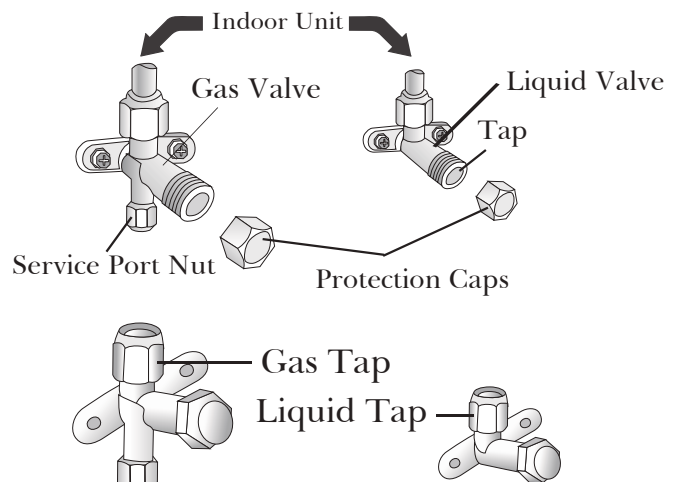

Outdoor Unit Installation Instructions

7

Air Evacuation and Bleeding the Circuit

The air and/or humidity left inside the refrigeration circuit can contaminate the refrigerant and cause abnormal spikes in pressure, leading to eventual compressor malfunction. Therefore, after having connected the indoor and outdoor units to create a closed system, it is necessary to bleed the air and humidity out of the circuit through the use of a vacuum pump.

Evacuation should be performed upon initial installation or when the unit is relocated.

BEFORE PERFORMING EVACUATION

- ✓ Check to make sure that both high-pressure and low-pressure pipes between the indoor and outdoor units are connected properly in accordance with the “Refrigerant Piping Connection” section of this manual.
- ✓ Check to make sure all wiring is connected properly.

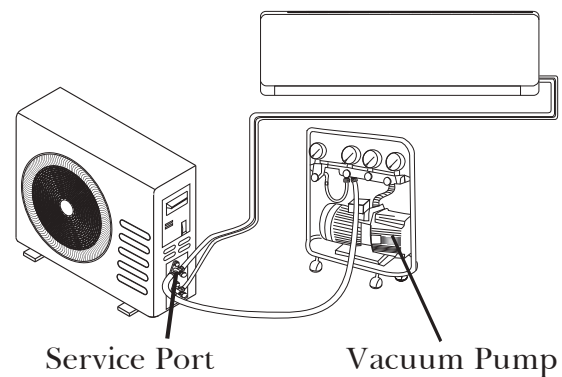

Evacuation Instructions

Before using a vacuum pump and manifold gauge, read their operation manuals to become familiarized with using them properly.

- 1) Unscrew and remove the caps from the 2-way and 3-way valves.
- 2) Unscrew and remove the cap from the service port.
- 3) Connect the blue (low) hose of the manifold gauge to service port on the outdoor unit's 3-way valve (use an adapter if needed). **Ensure that the pin fully engages the schrader valve.**
- 4) Connect the yellow (middle) hose from the manifold gauge to the vacuum pump.
- 5) Open the low pressure valve of the manifold gauge. Keep the high pressure valve closed.

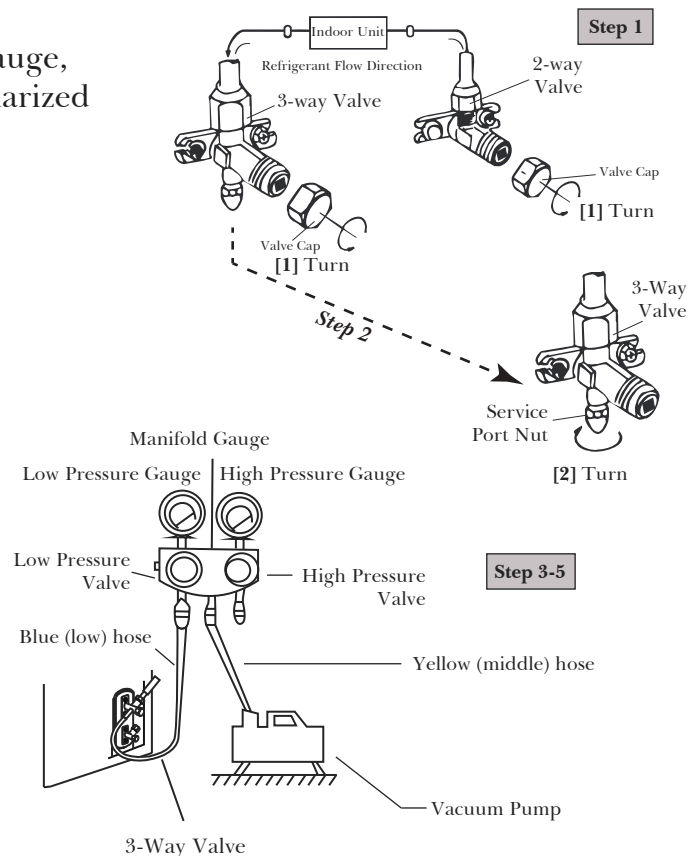

Outdoor Unit Installation Instructions

7

Evacuation Instructions (Cont'd)

6. Turn on the vacuum pump to evacuate the system.
7. Run the vacuum for at least 15 minutes, or until the Compound Meter reads -76cmHG (-100 kPa or -30 inHg).
8. Close the low pressure side of the manifold gauge, and turn off the vacuum pump.
9. Wait for 5 minutes, then verify that there has been no rise in the vacuum reading.
10. If there is a rise in the system vacuum, refer to “Gas Leak Check” section for information on how to check for leaks. If no change in vacuum reading, unscrew the cap from the service valve (high pressure valve).
11. Insert a hexagonal wrench into the service valve (2-way valve) and open the valve by turning the wrench in a 1/4 counterclockwise turn. Wait and listen for gas to exit the system, then close the valve after 5 seconds.
12. Watch the pressure gauge for a few minutes to make sure that there is no drop in pressure. The Pressure Gauge should now show higher than the atmospheric pressure.
13. Remove the charge hose from the service port.
14. Using a hexagonal wrench, fully open both the high pressure and low pressure valves.
15. Tighten valve caps on all three valves (service port, high pressure, low pressure) by hand. Tighten further using a torque wrench if needed.

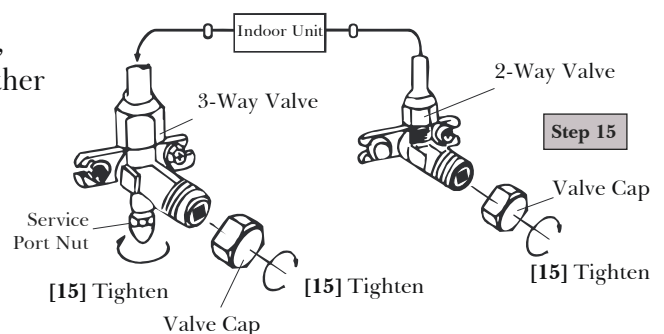
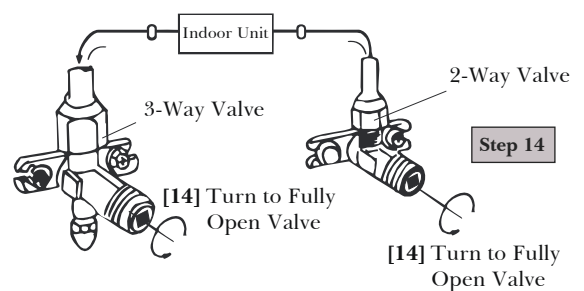
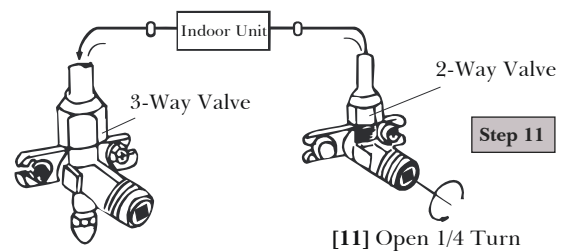
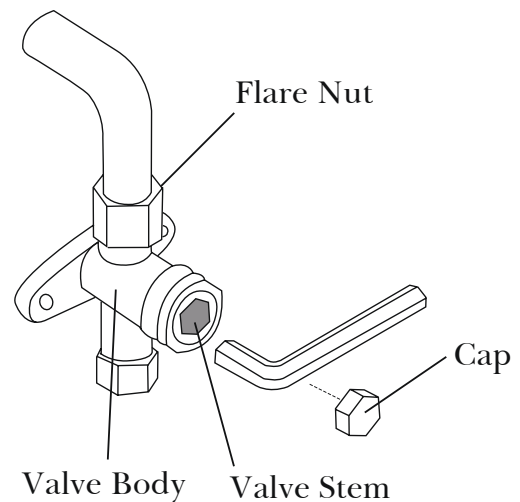

! OPEN VALVE STEMS GENTLY

When opening valve stems, turn the hexagonal wrench until it comes into contact with stopper. Do not try to force the valve to open further.

Electrical/Gas Leak Check and Test Run

8

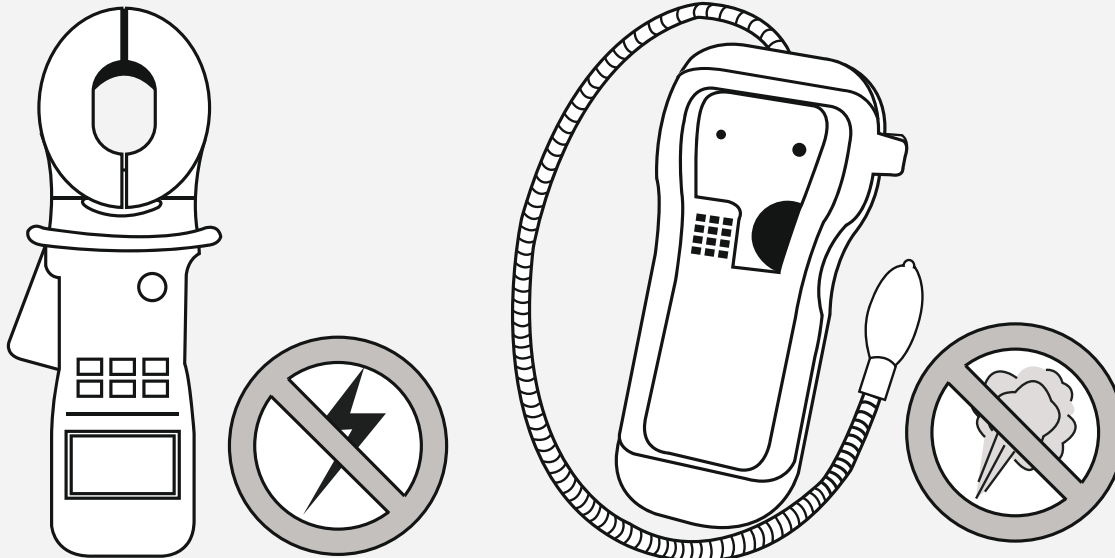

ELECTRICAL SAFETY CHECKS

After installation, confirm that all electrical wiring is installed in accordance with local and national regulations, and according to the Installation Manual.

BEFORE TEST RUN

- ✓ Check Grounding Work
- ✓ Measure grounding resistance by visual detection or with a grounding resistance tester. Grounding resistance must be less than 4Ω .
Note: This may not be required in some locations.

DURING TEST RUN

- ✓ Check for Electrical Leakage
- ✓ During the Test Run, use an electroprobe and multi-meter to perform a comprehensive electrical leakage test.
- ✓ If electrical leakage is detected, turn off the unit immediately and call a licensed electrician to find and resolve the cause of the leakage.
Note: This may not be required in some locations.

⚠ WARNING – RISK OF ELECTRIC SHOCK

ALL WIRING MUST COMPLY WITH LOCAL AND NATIONAL ELECTRICAL CODES, AND MUST BE INSTALLED BY A LICENSED ELECTRICIAN.

GAS LEAK CHECKS

There are 2 methods to check for gas leakage:

- ✓ **Soap and Water Method**
Using a soft brush, apply soapy water or liquid detergent to all pipe connection points on the indoor unit and outdoor unit. The presence of bubbles indicates a leak.
- ✓ **Leak Detector Method**
If using leak detector, refer to the device's operation manual for proper usage instructions.

AFTER PERFORMING GAS LEAK CHECKS

After confirming that the all pipe connection points DO NOT leak, replace the valve cover on the outside unit.

Electrical/Gas Leak Check and Test Run

8

Test Run

BEFORE TEST RUN

Only perform a test run after the following steps have been completed:

- Electrical Safety Checks**
Confirm that the unit's electrical system is safe and is operating properly.
- Gas Leak Checks**
Check all flare nut connections and confirm that the system is not leaking.
- Opened Valves**
Confirm that both the gas and liquid valves (high/low) are 100% fully opened.

TEST RUN INSTRUCTIONS

The following test run should be performed for 30 minutes:

1. Connect power to the unit.
2. Press the ON/OFF button on the remote controller to turn it on.
3. Press the MODE button to scroll through the following functions, one at a time:
 - COOL – Select lowest possible temperature
 - HEAT – Select highest possible temperature
4. Let each function run for 5 minutes, and perform the following checks:

PASS/FAIL?

- | | |
|--|--|
| <input type="checkbox"/> No Electrical Leaks or Abnormal Noises | <input type="checkbox"/> Water Drains From Drain Hose Properly |
| <input type="checkbox"/> Unit is Properly Grounded | <input type="checkbox"/> All Piping is Properly Insulated |
| <input type="checkbox"/> All Electrical Terminals Properly Covered | <input type="checkbox"/> Indoor Unit Responds to Remote Controller |
| <input type="checkbox"/> Indoor and Outdoor Units Securely Installed | <input type="checkbox"/> Indoor Unit Louvers Work Properly |
| <input type="checkbox"/> All Pipe Connections Points Do Not Leak | <input type="checkbox"/> System Works in Both HEAT + COOL mode |

AFTER TEST RUN COMPLETION

After the 10 boxes above have been checked as having PASSED, perform the following operation:

1. Using the remote control, return the system to a normal desired operating temperature.
2. Using insulation tape, wrap the indoor unit refrigerant pipe connections that were left uncovered during the indoor unit installation process.

IF AMBIENT TEMPERATURES ARE TOO LOW TO RUN A COOLING TEST:

If outside temperatures are too low to permit COOLING mode on the remote, do the following:

1. Turn the unit on using the emergency button as depicted on **Page 8**.
2. Run the cooling mode test as normal, and turn the unit back off using the button when complete.

DOUBLE CHECK ALL PIPE CONNECTIONS

During operation, the pressure of the refrigerant circuit will increase. This may reveal leaks that were not present during your initial leak check. Take time during the Test Run to double-check that all copper pipe connection points are leak-free. Refer to the Leak Check page for instructions. Cooling mode pressures should be 120-155 PSI. Heating mode pressures should be 320-440 PSI.

Troubleshooting

9

MALFUNCTION	POSSIBLE CAUSES
If the appliance does not operate or respond...	There is a power failure/plug pulled out
	The indoor/outdoor unit fan motor was damaged
	There is a faulty compressor or thermomagnetic circuit breaker
	There is a faulty protective device or fuses
	The electrical connections are loose
	The system has entered a protection mode
	The system has entered an overvoltage or undervoltage protection
	The TIMER-ON function is active
The electronic control board was damaged	
If there are strange odors...	The air filter is dirty
If there's running water...	There was a backflow of liquid into the refrigerant circulation.
If a fine mist is coming from the air outlet...	This occurs when the air in the room becomes very cold, for example in "COOLING" or "DEHUMIDIFICATION/DRY" modes
If strange noises are being emitted...	This noise is made by the expansion or contraction of the front panel due to variations in temperature, and if so, is normal
If the airflow is insufficient, and the air is not hot or cold enough...	The temperature setting is unsuitable
	The air conditioner intakes and outlets may be obstructed
	The air filter may be dirty
	The fan speed may be set at the minimum
	There may be too many other heat sources in the room
If the appliance does not respond to commands...	The system may be getting low on refrigerant, pressures should be checked
	The remote control may not be close enough to the indoor unit
If the display is off...	The batteries of remote control may need to be replaced
	There are obstacles between remote control and indoor unit signal receiver
	The DISPLAY button has been pressed
Switch off the air conditioner immediately and cut off the power supply in the event of...	There has been a power failure
	Strange noises not due to expansion/contraction are heard during operation
	The electronic control board is faulty or malfunctioning
	Any fuses or switches are faulty or malfunctioning
	The sound of spraying water or objects are heard inside the appliance
	The cables or plugs have overheated
There are very strong odors being emitted from the appliance	

ERROR SIGNALS ON THE DISPLAY

In case of error, the display on the indoor unit may show the following error codes:

Display	Description of the error	Display	Description of the trouble
E1	Indoor temperature sensor fault	E8	Outdoor discharge temperature sensor fault
E2	Indoor pipe temperature sensor fault	E9	Outdoor IPM module fault
E3	Outdoor pipe temperature sensor fault	EA	Outdoor current detection fault
E4	Refrigerant system leakage or fault	EE	Outdoor PCB EEPROM fault
E6	Malfunction of indoor fan motor	FY	Refrigerant Leak / Low Pressure Detected
E7	Outdoor air temperature sensor fault	EH	Outdoor suction temperature sensor fault

Appendix

A

Anchoring the Outdoor Unit

The outdoor unit can be anchored to the ground or to wall-mounted brackets. The following is a list of different outdoor unit sizes and the distance between their mounting feet. Prepare the installation base of the unit according to the dimensions found below:

Pioneer WYT Series Mini Split MODEL/Capacity (Btu/h)	A	B	D	H	W1	W2
WYT009ALFI19RL (9,000 BTU - 110/120V)	438 mm 17-1/4 in.	278 mm 10-15/16 in.	284 mm 11-3/16 in.	546 mm 21-1/2 in.	727.5 mm 28-5/8 in.	810 mm 31-7/8 in.
WYT012ALFI19RL (12,000 BTU - 110/120V)	438 mm 17-1/4 in.	278 mm 10-15/16 in.	284 mm 11-3/16 in.	546 mm 21-1/2 in.	727.5 mm 28-5/8 in.	810 mm 31-7/8 in.
WYT009GLFI19RL (9,000 BTU - 208/230V)	415 mm 16-11/32 in.	263 mm 10-3/8 in.	270 mm 10-5/8 in.	498 mm 19-5/8 in.	712 mm 28-1/32 in.	787 mm 31 in.
WYT012GLFI19RL (12,000 BTU - 208/230V)	415 mm 16-11/32 in.	263 mm 10-3/8 in.	270 mm 10-5/8 in.	498 mm 19-5/8 in.	712 mm 28-1/32 in.	787 mm 31 in.
WYT018GLFI19RL (18,000 BTU - 208/230V)	516 mm 20-5/16 in.	314 mm 12-3/8 in.	324 mm 12-3/4 in.	603.5 mm 23-3/4 in.	780 mm 30-11/16 in.	863 mm 34 in.
WYT024GLFI19RL (24,000 BTU - 208/230V)	586 mm 23-3/32 in.	347.5 mm 13-11/16 in.	361 mm 14-7/32 in.	699 mm 27-1/2 in.	850 mm 33-15/32 in.	927 mm 36-1/2 in.
WYT036GLFI19RL (36,000 BTU - 208/230V)	675 mm 26-19/32 in.	398 mm 15-11/16 in.	391 mm 15-3/8 in.	806 mm 31-3/4 in.	900 mm 35-7/16 in.	975 mm 38-3/8 in.

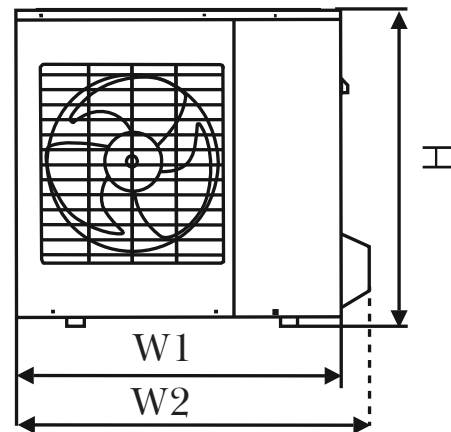
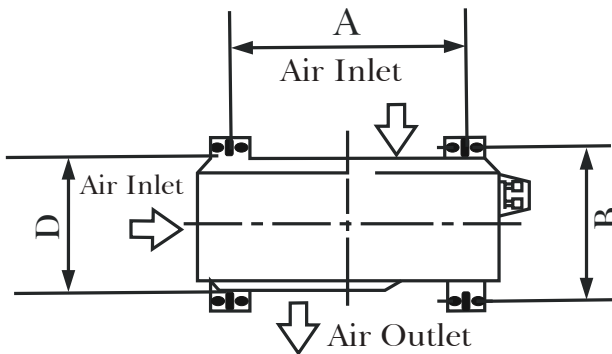

If installing the unit on the ground or on a concrete mounting platform, do the following:

1. Mark the positions for four expansion bolts based on dimensions in the “Unit Mounting Dimensions” chart.
2. Pre-drill holes for expansion bolts.
3. Clean concrete dust away from holes.
4. Place a nut on the end of each expansion bolt.

5. Hammer expansion bolts into each hole.
6. Remove the nuts from expansion bolts, and place the outdoor unit onto the bolts.
7. Put washers onto each expansion bolt, then replace each of the nuts.
8. Using a wrench, tighten each nut until snug.

**WHEN DRILLING INTO CONCRETE,
WEAR EYE PROTECTION AT ALL TIMES!**

Appendix

A

Guidelines for Drilling the Wall Hole

Below are the suggested locations for the wall hole for systems between 9,000 - 36,000 BTU. Both left side/right side exits are considered. Confirm holes are appropriate by corner tracing.

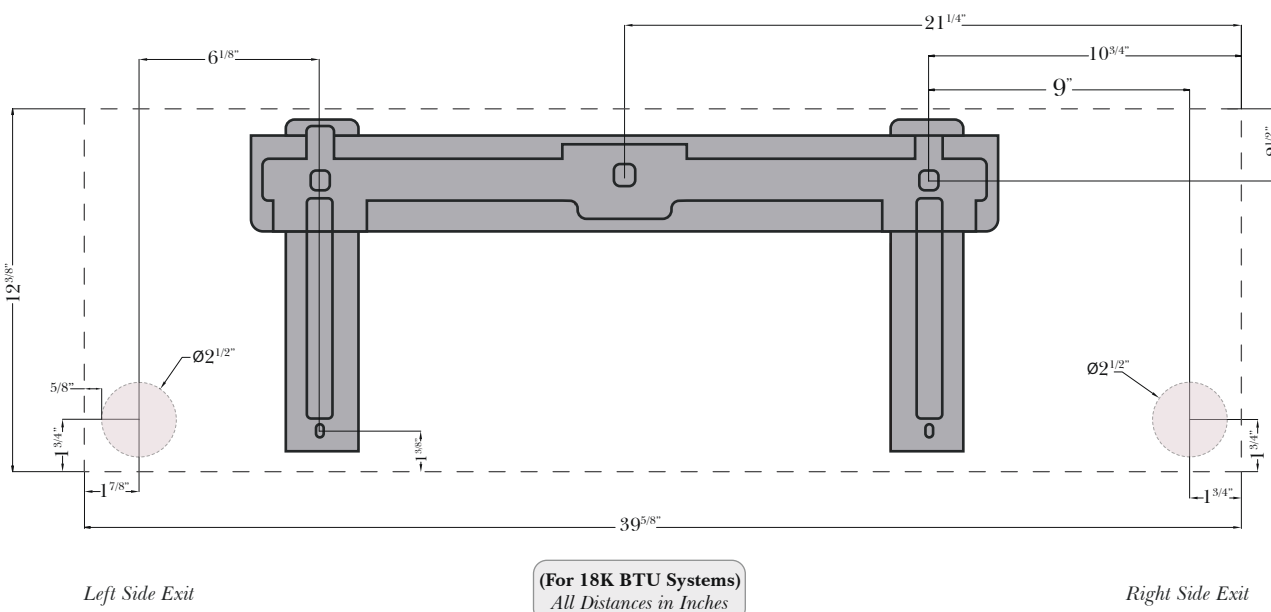
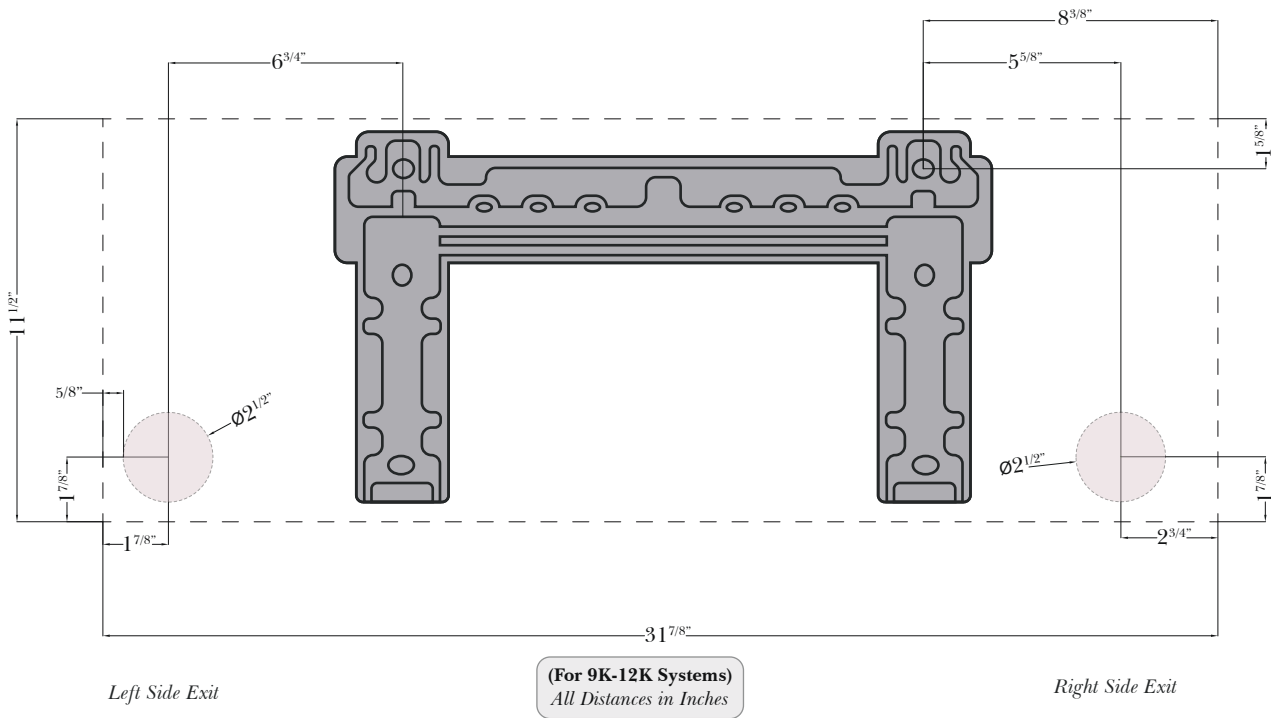

Appendix

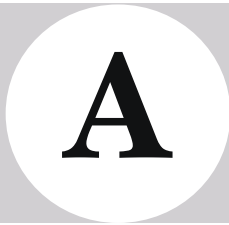

Guidelines for Drilling the Wall Hole (continued)

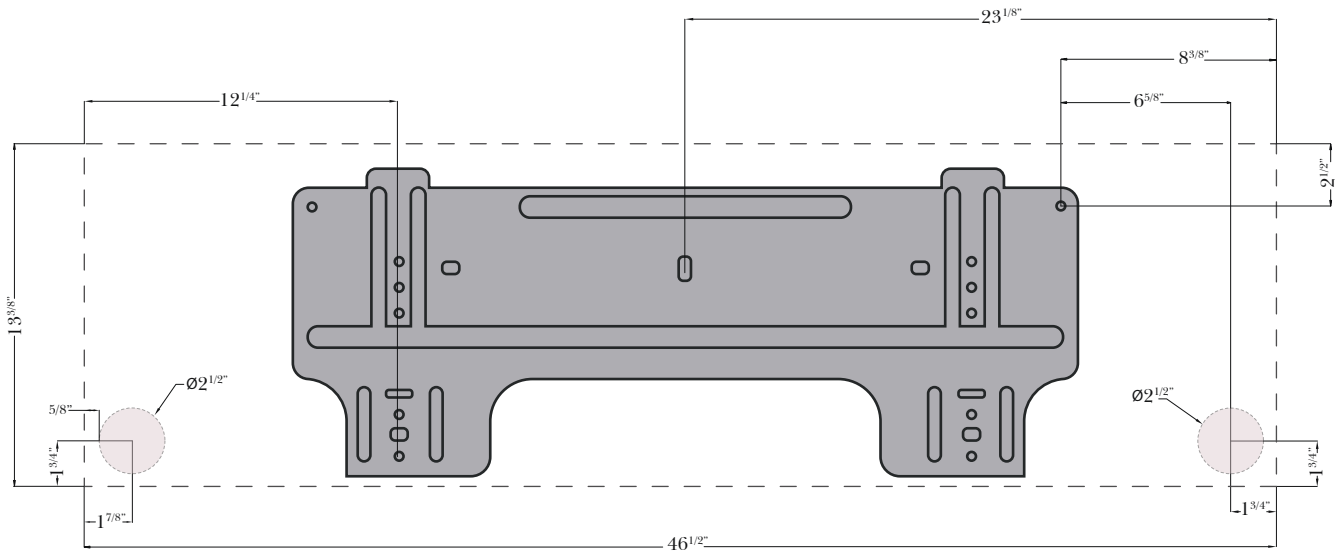

Left Side Exit

(For 24K-36K Systems)
All Distances in Inches

Right Side Exit

Simplified Wiring Diagram (115V and 230V)

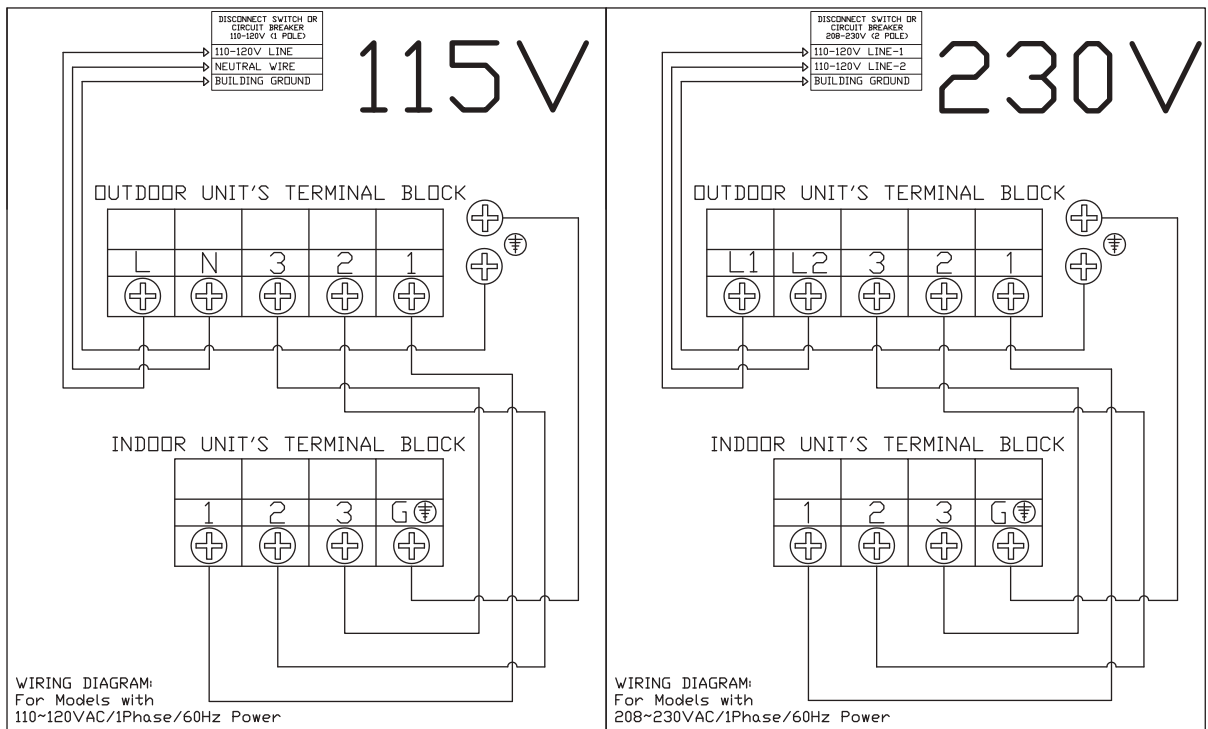

European Disposal Guidelines

This appliance contains refrigerant and other potentially hazardous materials. When disposing of this appliance, the law requires special collection and treatment. Do not dispose of this product as household waste or unsorted municipal waste.

When disposing of this appliance, you have the following options:

- Dispose of the appliance at a designated municipal electronic waste collection facility.
- When buying a new appliance, the retailer takes back the old appliance free of charge.
- The manufacturer takes back the old appliance free of charge.
- Sell the appliance to certified scrap metal dealers.

Special Notice

Disposing of this appliance improperly, or in other natural surroundings, endangers your health and is bad for the environment. Hazardous substances may leak into the ground water and enter the food chain. Please follow proper disposal protocol.

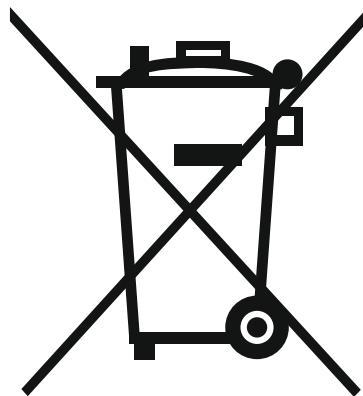

The design and specifications of this product are subject to change without prior notice as development continues. Consult with the sales agency or manufacturer for details. Refer to the equipment nameplate for all other applicable specifications.



is a registered trademark of Parker Davis HVAC International, Inc.

Parker Davis HVAC International, Inc.

3250 NW 107 Avenue, Doral, FL 33172 - USA

Tel : (305) 513-4488

Fax : (305) 513-4499

E-mail : info@pd-hvac.com

Website: www.pd-hvac.com

Pioneer product line, parts, and supplies are available online for convenient ordering at:

www.highseer.com

www.pioneerminisplit.com

Scan the below code to visit our support page where you can find more installation materials:

