



HVAC MIRAGE

Think **SMART**. Think **COOL**. Think **MIRAGE**.

hvacmirage.us

Job name: _____

Location: _____

Engineer: _____

Submitted to: _____

Submitted by: _____

Reference: _____

Approval: _____

Date: _____

Construction: _____

Unit #: _____

Drawing #: _____

Submittal Page

Model: Ventus X 36k-220V
IVKH361A - OVKH361A

Type			cooling&heating
Control type			remote
Power supply			230V~/60Hz/1P
Rated cooling capacity	Btu/h		36000
Rated Heating capacity	Btu/h		36000
SEER	Btu/W.h		17.0
HSPF Rating (Region IV)	Btu/W.h		8.5
EER	Btu/W.h		9.0
COP	W/W		2.8
Input Consumption	Cooling	W	4000.0
	Heating	W	3760.0
Rated Current	Cooling	A	17.7
	Heating	A	16.7
Maximum Operation Pressure	PSIG		550
Maximum Fuse Size	A		20
Indoor noise level at cooling	High/Med/Low		50/46/42
Outdoor noise level		dB(A)	58
Connecting Pipe	Gas	inches	5/8"
	Liquid	inches	1/4"
Net dimensions (W x D x H)	Indoor	inch	46.69x13.38x10.23
	Outdoor	inch	35.43x14.17x31.69
Net weight	Indoor	lbs	38.6
	Outdoor	lbs	136.7
Indoor Unit			
Indoor Motor	Motor Model		DC
Indoor air circulation / Hi		CFM	850
Outdoor Unit			
Compressor Brand			GMCC
Compressor Model	Operation temperature	DC	
Outdoor Motor	Motor Brand	Weilling/Broad-Ocean	
Outdoor Motor	Motor Model	DC	
Outdoor air circulation/Hi		CFM	2110
Factory Refrigerant R410a charge		oz	86.42
Line Set Size		ft	16
Maximum Allowed Length		ft	98
Maximum Allowed Height		ft	65
Operation temperature		°F	61 ~ 88
Additional refrigerant Charge		Oz/Ft	0.312



HVAC MIRAGE

Think SMART. Think COOL. Think MIRAGE.

Submittal Page

Model: Ventus X 36k-220V
IVKH361A - OVKH361A

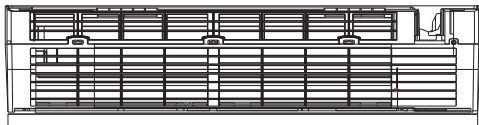
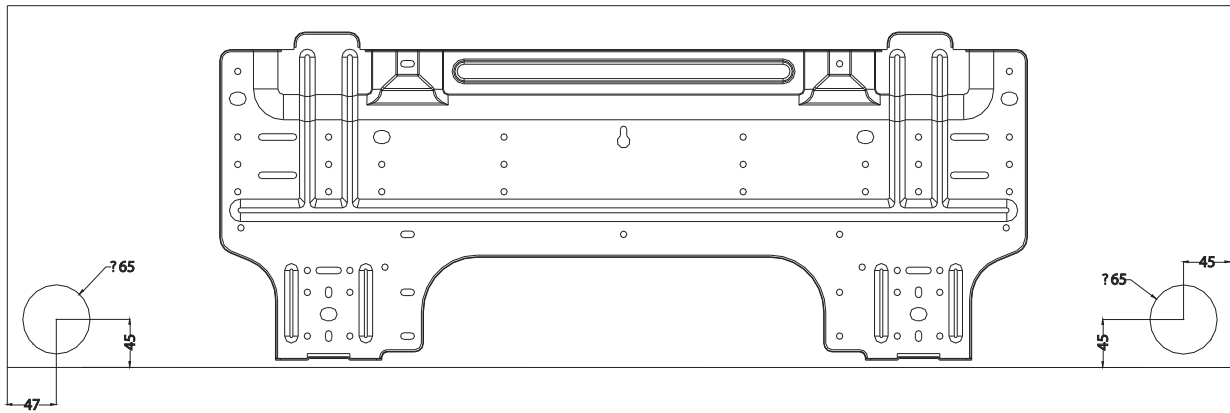

W

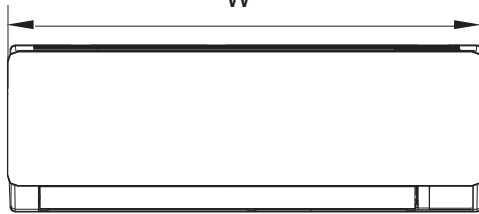

D

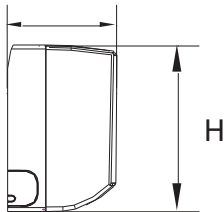

H

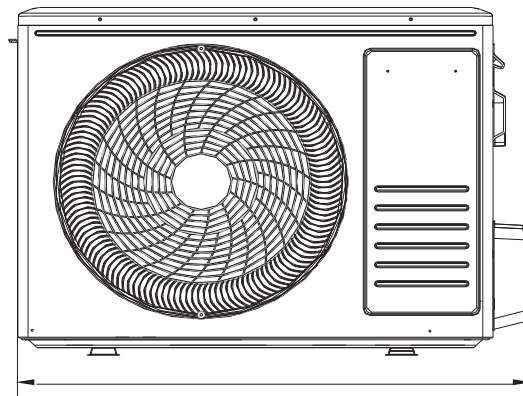
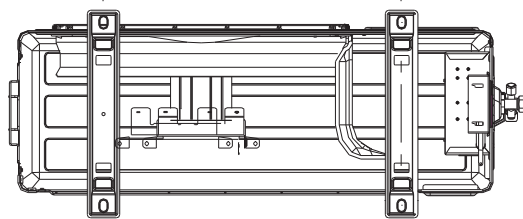

W

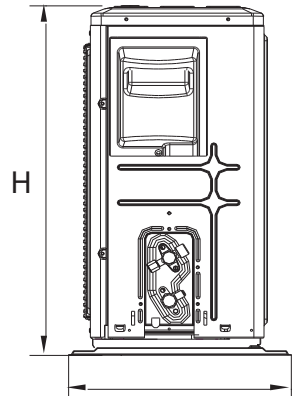

H

D