

# EG4® 6000XP OFF-GRID INVERTER

## USER MANUAL



## TABLE OF CONTENTS

1.	TECHNICAL SPECIFICATIONS .....	1
2.	ABBREVIATIONS.....	3
3.	SAFETY.....	4
3.1	SAFETY INSTRUCTIONS.....	4
3.2	IMPORTANT SAFETY NOTIFICATIONS .....	4
4.	BRIEF INTRODUCTION.....	6
4.1	INVERTER FEATURES.....	6
4.2	INVERTER INTERFACE .....	7
5.	INSTALLATION.....	8
5.1	PACKING LIST .....	8
5.2	LOCATION SELECTION AND INSTALLATION.....	8
5.3	STORAGE INFORMATION .....	9
5.3.1	INSTALLING THE INVERTER .....	10
5.3.2	MOUNTING STEPS.....	10
5.4	CONNECTION OVERVIEW.....	11
5.4.1	SYSTEM CONNECTIONS.....	11
5.5	PV CONNECTION.....	11
5.5.1	CONNECTING PV TO THE INVERTER.....	11
5.5.2	STRING SIZING.....	12
5.5.3	PV WIRING INSTRUCTIONS.....	13
5.6	BATTERY CONNECTION.....	14
5.6.1	BATTERY CABLE CONNECTION .....	14
5.6.2	LITHIUM BATTERY COMMUNICATIONS.....	15
5.7	AC WIRING INFORMATION .....	17
5.7.1	STEPS FOR AC CONNECTION.....	17
5.8	WORKING WITH A GENERATOR.....	18
5.8.1	INTEGRATED TWO-WIRE START/STOP .....	18
5.8.2	GENERATOR AC CONNECTIONS .....	19
5.9	GENERATOR START AND STOP SETTINGS .....	19
5.10	OFF-GRID .....	19
5.10.1	OFF-GRID WIRING .....	20
5.11	PARALLELING INFORMATION.....	20
5.11.1	PARALLEL COMMUNICATION CONNECTIONS.....	20
5.11.2	PARALLEL CONFIGURATION.....	20
6.	END USER SETTINGS .....	22
6.1	APPLICATION SETTING .....	22
6.2	CHARGE SETTING .....	22
6.2.1	GENERATOR CHARGE .....	23
6.3	DISCHARGE SETTING.....	23
6.4	RESET.....	23
7.	INSTALLER SETTINGS.....	24
7.1	COMMON SETTING .....	24
7.2	APPLICATION SETTING .....	25
7.3	CHARGE SETTING .....	26
7.4	DISCHARGE SETTING.....	28
7.5	OTHER SETTING.....	29

7.6	RESET.....	29
8.	MONITOR SYSTEM SETUP .....	30
8.1	WI-FI/4G/LAN DONGLE CONNECTION.....	30
8.2	THIRD-PARTY RS485 COMMUNICATION.....	30
8.3	ONLINE MONITORING SYSTEM USER INTERFACE .....	31
8.3.1	DASHBOARD (MONITOR TAB) .....	31
8.3.2	DASHBOARD (DATA TAB) .....	34
8.3.3	DASHBOARD (CONFIGURATION TAB).....	37
8.3.4	DASHBOARD (OVERVIEW TAB).....	38
8.3.5	DASHBOARD (MAINTENANCE TAB).....	39
9.	FIRMWARE UPDATES.....	40
9.1	FIRMWARE UPDATE VIA EG4 ELECTRONICS APP.....	40
9.2	FIRMWARE UPDATE VIA MONITOR CENTER (WEBSITE) .....	41
10.	SMARTPHONE APP SETUP .....	42
11.	WORKING MODES.....	43
11.1	RAPID SHUTDOWN (RSD).....	44
11.1.1	EXTERNAL RSD WIRING INSTRUCTIONS.....	45
11.2	LCD DISPLAY AND SETTINGS.....	46
11.2.1	LCD DISPLAY .....	46
12.	LCD SETTINGS.....	48
13.	INVERTER START-UP AND SHUT DOWN PROCEDURE.....	58
13.1	START-UP.....	58
13.2	SHUT DOWN .....	58
14.	ERROR/WARNING TABLES.....	59
14.1	ERROR DEFINITIONS AND TROUBLESHOOTING .....	59
14.2	WARNING DEFINITIONS AND TROUBLESHOOTING .....	60
15.	INVERTER MAINTENANCE .....	62

## 1. TECHNICAL SPECIFICATIONS

AC INPUT DATA		
NOMINAL AC VOLTAGE		120/240VAC (L1/L2/N required)
FREQUENCY		50/60Hz
MAX. CONTINUOUS AC CURRENT		37.5A @ 240VAC
MAX. AC INPUT POWER		9000W
AC BYPASS (GRID   GENERATOR)		50A
AC OUTPUT DATA		
OUTPUT VOLTAGE		120/240VAC
OUTPUT FREQUENCY		50/60Hz
MAX. CONTINUOUS OUTPUT CURRENT @ 240V		25A (per line)
MAX CONT. LINE WATTAGE		3000W
NOMINAL POWER OUTPUT		6000W
SURGE CAPACITY		12,000W for ≈3.5 seconds   11,000W for ≈5 seconds
POWER FACTOR		0.99 @ full load
REACTIVE POWER ADJUST RANGE		(-0.8) – (+0.8) leading adjustable
OPERATING FREQUENCY		50/60Hz
THD (V)		<3%
SWITCHING TIME		<15ms @ Single / <30ms @ Parallel
PV INPUT DATA		
NUMBER OF MPPTS		2
INPUTS PER MPPT		1
MAX. USABLE INPUT CURRENT		17/17A
MAX. SHORT CIRCUIT INPUT CURRENT		25/25A
DC INPUT VOLTAGE RANGE		100-480 VDC
UNIT STARTUP VOLTAGE		100 VDC ± 10 VDC
MPP OPERATING VOLTAGE RANGE		120-385 VDC
NOMINAL MPPT VOLTAGE		320 VDC
MAXIMUM UTILIZED SOLAR POWER		8000W (4000W per MPPT)
RECOMMENDED MAXIMUM SOLAR INPUT		10000W
BATTERY DATA		
TYPE		Lead-acid/Lithium
MAX. DISCHARGE CURRENT		140A
MAX. CHARGE CURRENT		125A**
NOMINAL VOLTAGE		48 VDC
BATTERY VOLTAGE RANGE		46.4 – 60 VDC (Lithium)   38.4 – 60 VDC (Lead-acid)
REC. BATTERY CAPACITY PER INVERTER		>200Ah
HIGH DC CUT-OFF VOLTAGE		59 VDC (Lithium)   60 VDC (Lead-acid)
HIGH DC RECOVERY VOLTAGE		57.4 VDC(Lithium)   58 VDC(Lead-Acid)
	LOAD<20%	44.0 VDC (Configurable)
LOW DC WARNING VOLTAGE (LEAD-ACID)	20%≤LOAD<50%	Warning Voltage @Load <20% - 1.2V
	LOAD≥50%	Warning Voltage @Load <20% - 3.6V
LOW DC WARNING VOLTAGE RETURN (LEAD-ACID)		Low DC Warning Voltage @Different Load +2V

	LOAD<20%	42.0 VDC (Configurable)
LOW DC CUT-OFF VOLTAGE (LEAD-ACID)	20%≤LOAD<50%	Cut-Off Voltage @Load <20% - 1.2V
	LOAD≥50%	Cut-Off Voltage @load <20% - 3.6V
LOW DC CUT-OFF RETURN VOLTAGE (LEAD-ACID)	CUT-OFF VOLTAGE @LOAD <20% ≥45V	Low DC Cut-Off Voltage @load <20% +3V
	CUT-OFF VOLTAGE @LOAD <20% <45V	
LOW DC WARNING SOC		20% SOC (Configurable)
LOW DC WARNING RETURN SOC		Low DC Warning SOC +10%
LOW DC CUT-OFF SOC		15% SOC (Grid ON) (Configurable)
		15% SOC (Grid OFF) (Configurable)
LOW DC CUT-OFF RETURN SOC		Low DC Cut-Off SOC +10%
CHARGE CUT-OFF VOLTAGE		58.4 VDC
<b>GENERAL DATA</b>		
MAX. UNITS IN PARALLEL		16
INTEGRATED DISCONNECT		Yes
DC SWITCH RATING FOR EACH MPPT		Yes
DIMENSIONS		18×25.5×5.25 in (457×648×132mm)
WEIGHT		52.9 lbs. (24kg)
COOLING CONCEPT		Fan
TOPOLOGY		TL (Transformerless)
RELATIVE HUMIDITY		5-95%
ALTITUDE		<6561ft (2000m)
OPERATING TEMPERATURE RANGE		32 – 113°F (0 – 45°C)
STORAGE TEMPERATURE RANGE		5 – 140°F (-15 – 60°C)
NOISE EMISSION (TYPICAL)		<58 dB
DISPLAY		LCD + LED
COMMUNICATION INTERFACE		RS485/Wi-Fi/CAN
STANDARD WARRANTY		5-year standard warranty***
PV REVERSE POLARITY PROTECTION, POLE SENSITIVE LEAKAGE CURRENT MONITORING UNIT, SURGE PROTECTION DEVICE, OUTPUT OVER-VOLTAGE PROTECTION, OUTPUT OVER-VOLTAGE PROTECTION VARISTOR		Yes
<b>EFFICIENCY</b>		
MPPT		99%
BATTERY CHARGING		93%
BATTERY DISCHARGING		93%
IDLE CONSUMPTION (STANDBY)		w/ PV (<30W)   w/ Battery (~50W)   w/ AC (<50W)*
<b>STANDARDS AND CERTIFICATIONS</b>		
UL1741		
FCC PART 15, CLASS B		
<b>INGRESS PROTECTION RATING</b>		
IP20		

\*Idle consumption value tested with constant 300 VDC PV source

\*\*115A @ 48 VDC (AC), 125A @48 VDC (PV)

\*\*\*See EG4 Warranty Registration for terms and conditions



## 2. ABBREVIATIONS

- AWG – American Wire Gauge
- A – Amps
- Ah – Amp hour(s)
- AC – Alternating Current
- AFCI – Arc-Fault Circuit Interrupter
- AHJ – Authority Having Jurisdiction
- kAIC – kilo-Amp Interrupting Capability
- ANSI – American National Standards Institute
- BAT – Battery
- BMS – Battery Management System
- COM – Communication
- CT – Current Transformer
- DC – Direct Current
- DIP – Dual In-line Package
- DOD – Depth of Discharge
- EG – Equipment Ground
- EGS – Equipment Grounding System
- EMC – Electromagnetic Compatibility
- EPS – Emergency Power System
- ESS – Energy Storage System
- E-Stop – Emergency Stop
- FCC – Federal Communication Commission
- GE – Grounding Electrode
- GEC – Grounding Electrode Conductor
- GFCI – Ground Fault Circuit Interrupter
- GFDI – Ground Fault Detector/Interrupter
- Imp – Maximum Power Point Current
- IEEE – Institute of Electrical and Electronic Engineers
- IP – Ingress Protection
- I<sub>sc</sub> – Short-Circuit Current
- In-lbs. – Inch Pounds
- kW – Kilowatt
- kWh – Kilowatt-hour
- LCD – Liquid Crystal Display
- LFP – Lithium Iron Phosphate
- L1 – Line 1
- L2 – Line 2
- mm – Millimeters
- MPPT – Maximum Power Point Tracking
- mV – Millivolt
- N – Neutral
- NEC – National Electric Code
- NEMA – National Electrical Manufacturers Association
- NFPA – National Fire Prevention Association
- Nm – Newton Meters
- NOCT – Normal Operating Cell Temperature
- PC – Personal Computer
- PCB – Printed Circuit Board
- PE – Protective Earth
- PPE – Personal Protective Equipment
- PV – Photovoltaic
- RSD – Rapid Shut Down
- SCC – Standards Council of Canada
- SOC – State of Charge
- STC – Standard Testing Conditions
- UL – Underwriters Laboratories
- UPS – Uninterrupted Power Supply
- V – Volts
- VOC – Open-Circuit Voltage
- VMP – Voltage Maximum Power

## 3. SAFETY



**DANGER!**

**AVERTISSEMENT!**

***Hazardous Voltage Circuits!***

***Circuits à tension élevée!***

### 3.1 SAFETY INSTRUCTIONS

International safety regulations have been strictly observed in the design and testing of the inverter. Before beginning any work, carefully read all safety instructions, and always observe them when working on or with the inverter. The installation must follow all applicable national or local standards and regulations.

**Incorrect installation may cause:**

- Injury or death to the installer, operator or third party
- Damage to the inverter or other attached equipment

### 3.2 IMPORTANT SAFETY NOTIFICATIONS

There are various safety concerns that must be carefully observed before, during, and after the installation, as well as during future operation and maintenance. The following are important safety notifications for the installer and any end users of this product under normal operating conditions.

1. **Beware of high PV voltage.** Please install an external DC disconnect switch or breaker and ensure it is in the “off” or “open” position before installing or working on the inverter. Use a voltmeter to confirm there is no DC voltage present to avoid electric shock.
2. **Beware of high grid voltage.** Please ensure the AC switch and/or AC breaker are in the “off” or “open” position before installing or working on the inverter. Use a voltmeter to confirm there is no voltage present to avoid electric shock.
3. **Beware of high battery current.** Please ensure that the battery module breakers and/or on/off switches are in the “open” or “off” position before installing or working on the inverter. Use a voltmeter to confirm there is no DC voltage present to avoid electric shock.
4. **Do not open the inverter while it is operating** to avoid electric shock and damage from live voltage and current within the system.
5. **Do not make any connections or disconnections (PV, battery, grid, communication, etc.) while the inverter is operating.**
6. An installer should make sure to be well protected by reasonable and professional insulative equipment [e.g., personal protective equipment (PPE)].
7. Before installing, operating, or maintaining the system, it is important to inspect all existing wiring to ensure that it meets the appropriate specifications and conditions for use.
8. Some components of the system can be very heavy. Please use the team lift technique or other safe lifting practices when performing the installation.
9. Ensure that the PV, battery, and grid connections to the inverter are secure and proper to prevent damage or injuries caused by improper installation.



**WARNING:** *To reduce the risk of injury, read all instructions!*

**All work on this product (system design, installation, operation, setting, configuration, and maintenance) must be carried out by qualified personnel. To reduce the risk of electric shock, do not perform any servicing other than those specified in the operating instructions unless you are qualified to do so.**

1. Read all instructions before installing. For electrical work, follow all local and national wiring standards, regulations, and these installation instructions.
2. Make sure the inverter is properly grounded. All wiring should be in accordance with the National Electrical Code (NEC), ANSI/NFPA 70.
3. The inverter and system can inter-connect with the utility grid only if the utility provider permits. Consult with your local AHJ (Authority Having Jurisdiction) before installing this product for any additional regulations and requirements for the area.
4. All warning labels and nameplates on this inverter should be clearly visible and must not be removed or covered.
5. The installer should consider the safety of future users when choosing the inverter's correct position and location as specified in this manual.
6. Please keep children away from touching or misusing the inverter and relevant systems.



**CAUTION:** The inverter and some parts of the system can be hot when in use. Please do not touch the inverter's surface or most of the parts when they are operating. During operation, only the LCD and buttons should be touched.

## **DISCLAIMER**

EG4 reserves the right to make changes to the material herein at any time without notice.

Please refer to [www.eg4electronics.com](http://www.eg4electronics.com) for the most updated version of our manuals/spec sheets.



## 4. BRIEF INTRODUCTION

### 4.1 INVERTER FEATURES

- Applicable for purely off-grid inverter/backup power situations.
- Integrated with 2 MPPT solar charge controllers each supporting a maximum PV input of 480V with an optimal range of 120VDC-385VDC.
- Additional safety features such as PV Arc Fault Protection and PV Ground Fault Protection.
- Rated for 6kW output, with a power factor of 1.
- Able to run without battery in off-grid mode.
- Able to utilize generators with dedicated generator terminals.
- Supports paralleling for up to 16 inverters.
- Supports CAN/RS485 for lithium battery communications.
- Features remote monitoring and firmware updates via mobile phone app or monitoring system website.

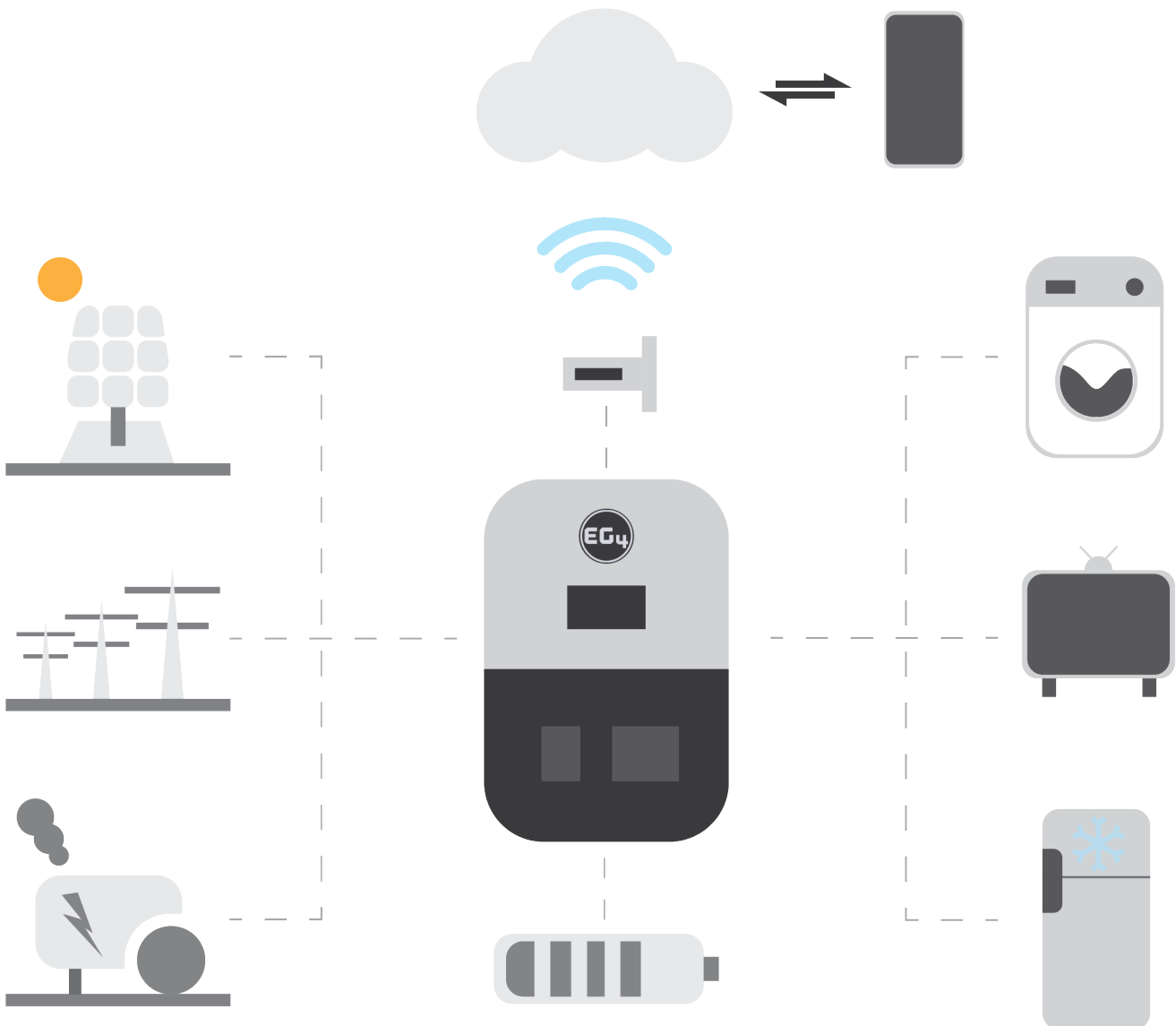



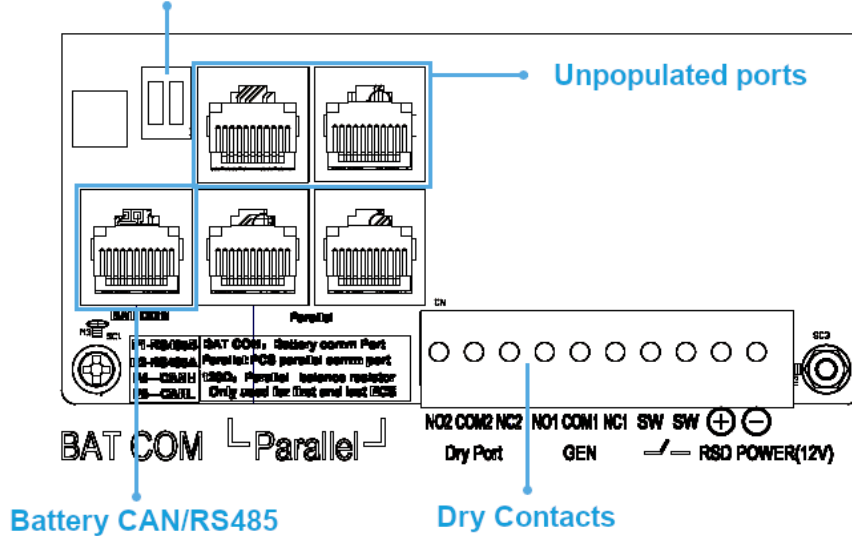
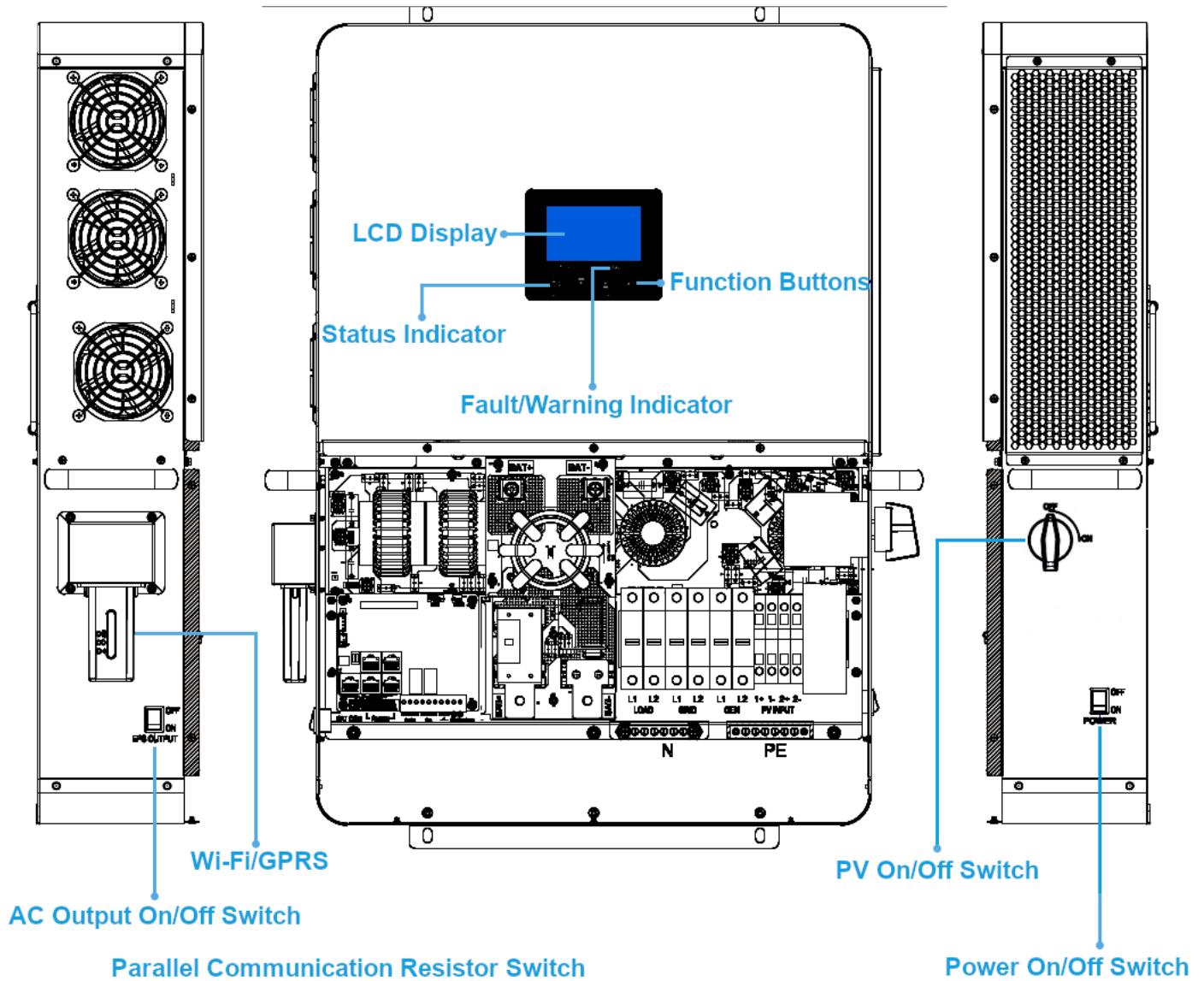

## 4.2 INVERTER INTERFACE

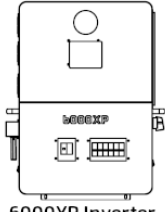

## 5. INSTALLATION

### 5.1 PACKING LIST

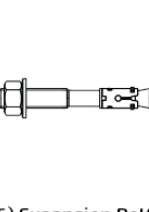
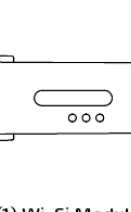
When the product is unpacked, the contents should match those listed below. Pictures are for reference only, subject to our available products.

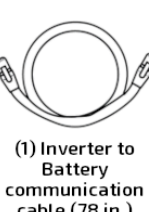
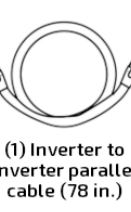
 <p>6000XP Inverter</p>	 <p>User Manual</p>	 <p>(6) Expansion Bolts</p>	 <p>(1) Wi-Fi Module</p>
 <p>Cross-head bolts (2) M8 Flange Nut (4) M3 x 10</p>	 <p>(1) Mounting Template</p>	 <p>(1) Inverter to Battery communication cable (78 in.)</p>	 <p>(1) Inverter to Inverter parallel cable (78 in.)</p>

### 5.2 LOCATION SELECTION AND INSTALLATION

1. The mounting wall should be strong enough to bear the weight of the inverter.
2. Please maintain the minimum clearances presented below for adequate heat dissipation.
3. The inverter should be installed upright on a vertical surface.

#### Inverter Spacing Diagram

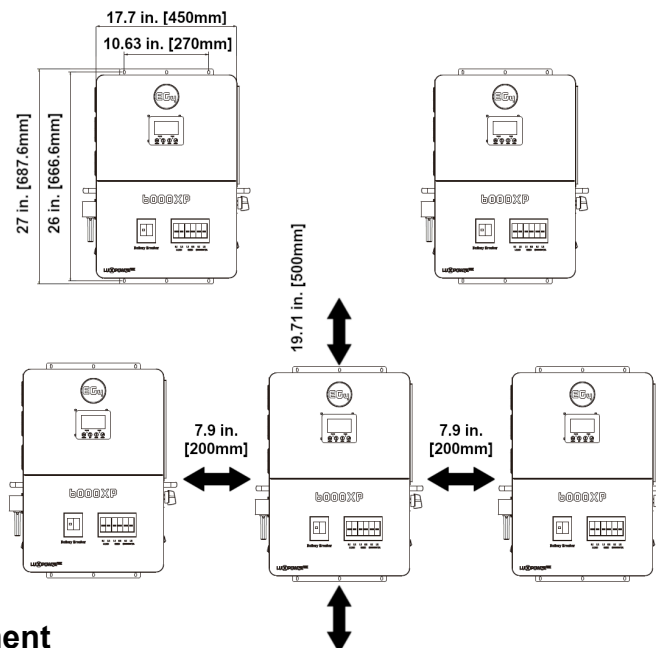

#### Inverter Angle Placement

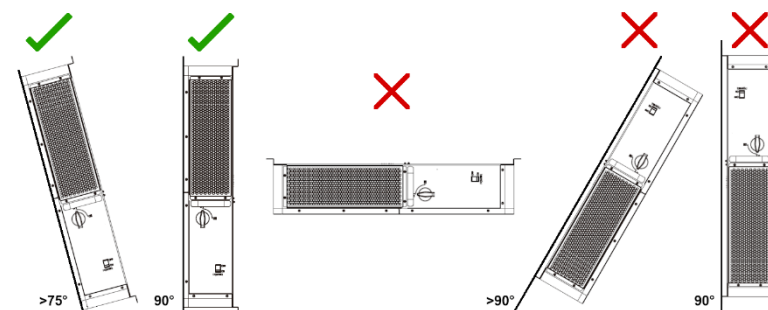

## 5.3 STORAGE INFORMATION

If placing the inverter into storage before installation, please keep the following factors in mind when selecting a storage location:

1. The inverter and its components must be stored in its original packaging.
2. The storage temperature should remain within 5 – 140°F (-15 – 60°C), and humidity within 0-85%.
3. The package should remain upright.
4. **Do not** store the inverter or its packaging in direct sunlight or where there is potential for water to accumulate.
5. See diagram below for an example.

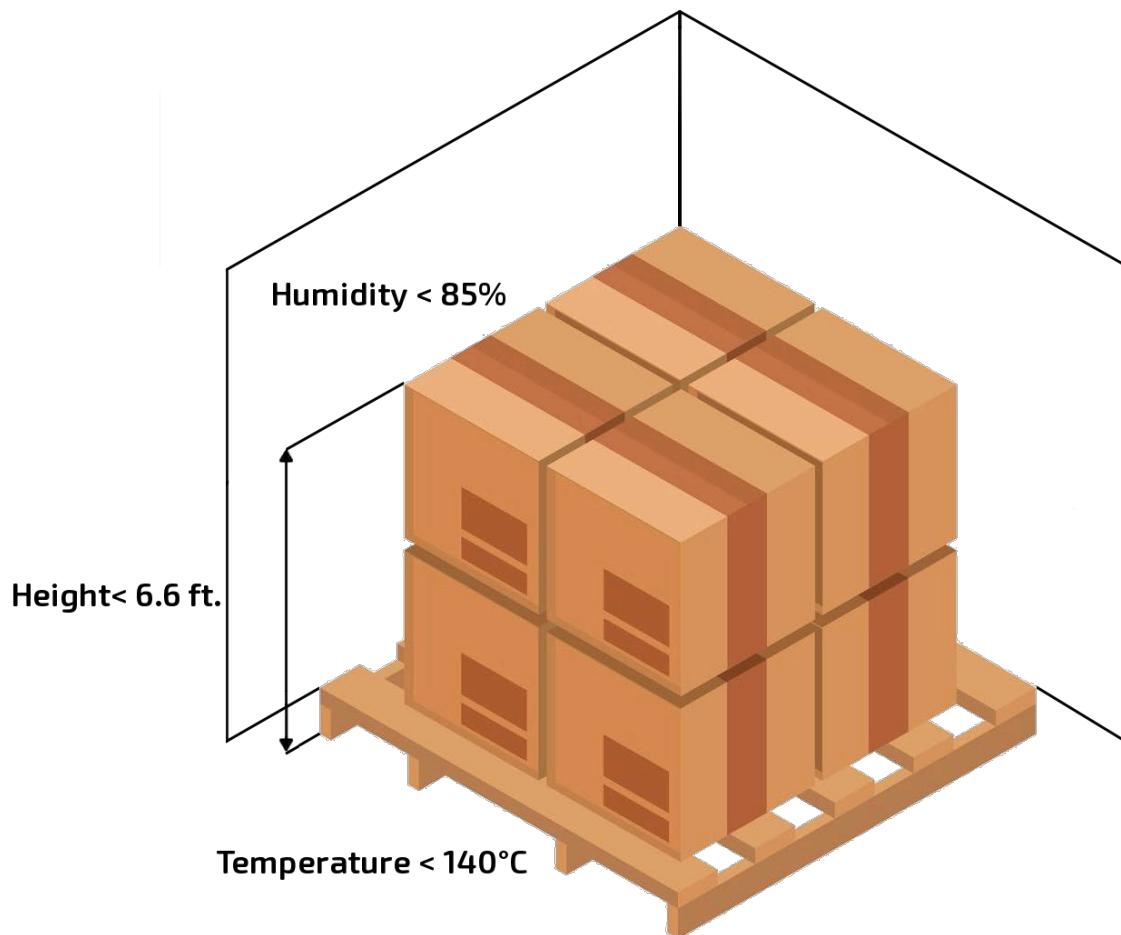

## 5.3.1 INSTALLING THE INVERTER

The inverter is designed to be wall-mounted and should be installed on a vertical, solid, mounting surface, such as brick, concrete, or other **non-combustible** material. Two or more people may be needed to install the inverter due to its weight ( $\approx 53$  lbs.).

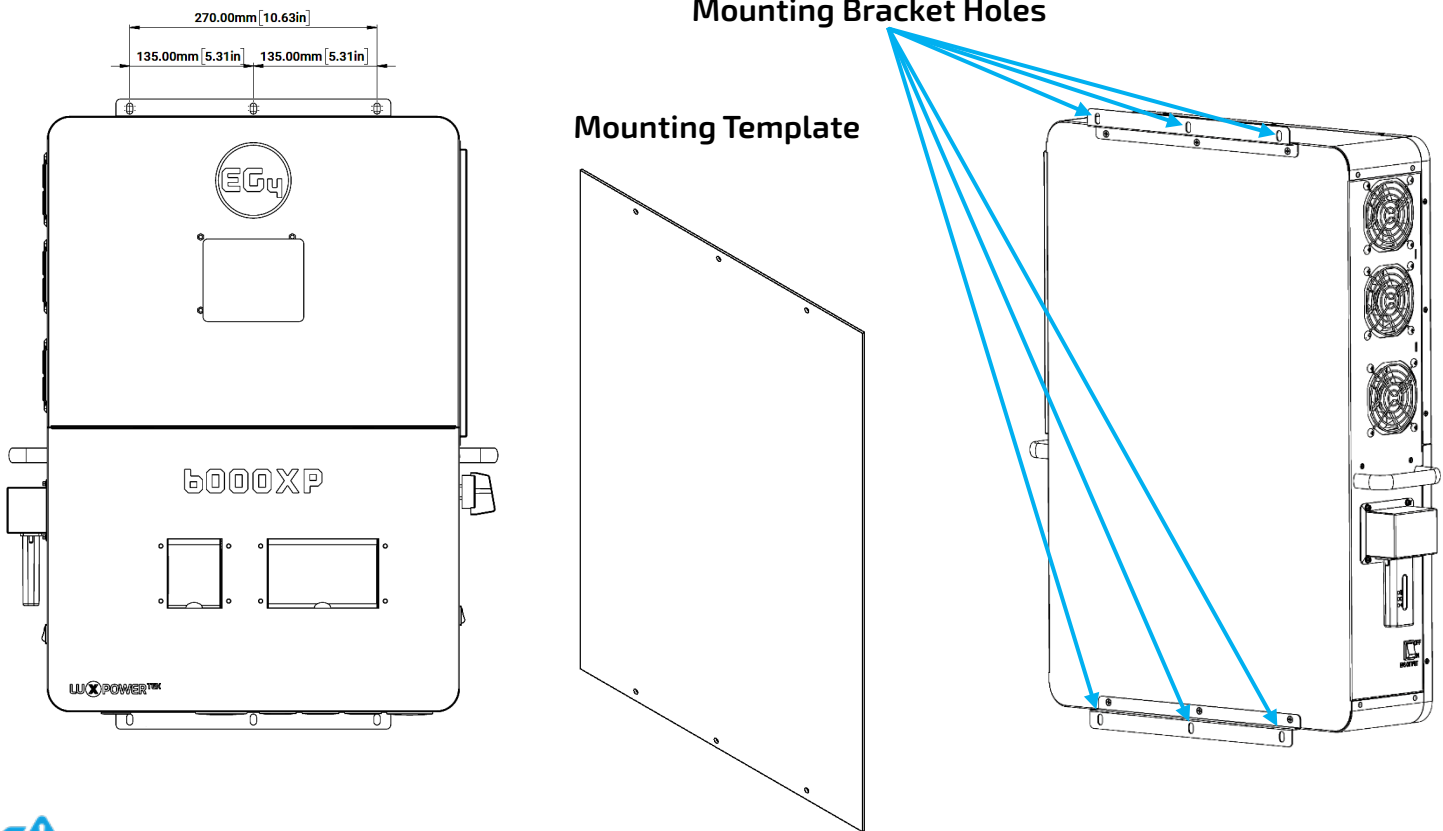

**NOTE:** Ensure the surface the inverter is being mounted to is able to support the weight of the unit and has proper spacing as per the diagram on the previous page.

## 5.3.2 MOUNTING STEPS

1. Identify where the inverter's final placement will be.
2. Use the included cardboard template to mark where the mounting screws will be installed.
3. Using a ruler, ensure the top left to top right marks are  $\approx 10.63$  in. (270mm) apart, along with the bottom left to bottom right marks.
4. Using a ruler, ensure the top left to bottom left marks are  $\approx 26.2$  in. (665mm), along with the top right to bottom right marks.
5. Place the inverter over the holes to ensure they line up with the bracket plate. Upon confirmation, proceed to the next step.
6. Drill  $5/16$  in. (8mm) diameter holes on the marks, making sure the holes are deeper than 2 in. (50mm) when using the included expansion bolts.
7. Insert the expansion bolts into the drilled holes.
8. Use the corresponding nuts and washers (packaged together with the expansion bolts) to install and affix the inverter onto the wall. Use the team-lift technique to ensure the users' safety.

## 5.4 CONNECTION OVERVIEW

### 5.4.1 SYSTEM CONNECTIONS

Before connecting wiring, please remove the bottom cover by removing the 7 screws as shown below.

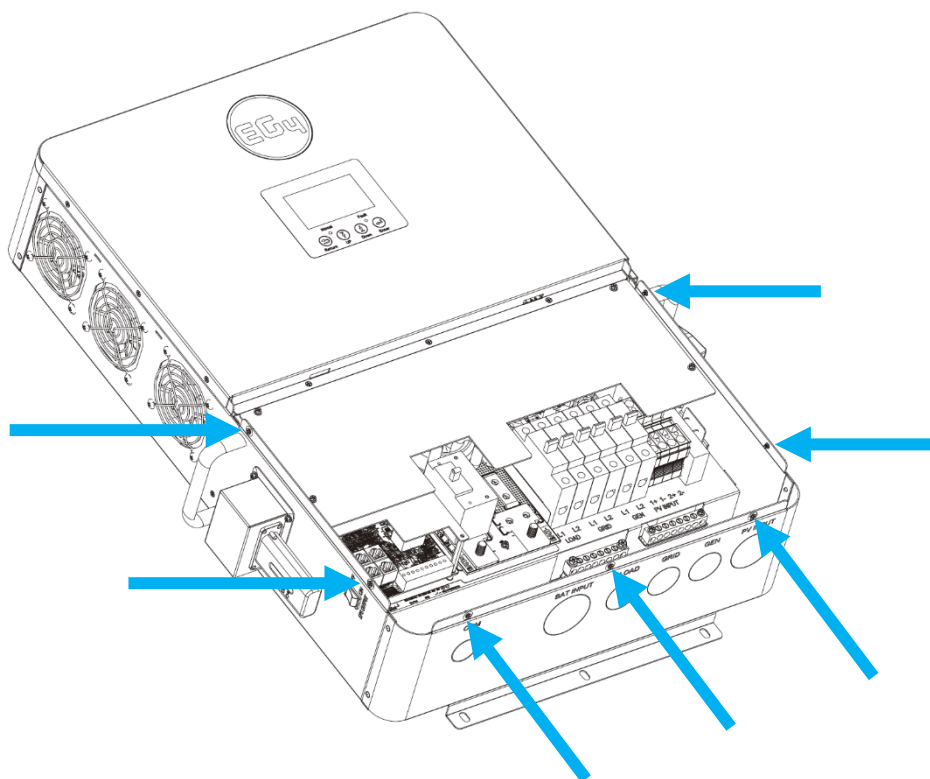

## 5.5 PV CONNECTION

### 5.5.1 CONNECTING PV TO THE INVERTER

Install a separate DC circuit breaker/isolator between the inverter and PV module(s). The recommended DC breaker is a 4-pole 600V/20A, which is the minimum sized isolator switch to house both positives and both negatives if using two independent strings. If only using 1 string, a 2 pole 600V/20A isolator/breaker is recommended. The recommended cable size for the PV connection(s) is 10 AWG (4mm<sup>2</sup>) torqued to 10.6 in-lbs. (1.2 Nm).

Consult with the installer to ensure that appropriate cable sizing is used due to various factors such as voltage drop and Voc.

PV Cable Size	Min. PV Disconnect/Isolator Spec	Torque Specs
10 AWG – 6 AWG (Max) (6mm <sup>2</sup> - 16mm <sup>2</sup> )	600V/20A	10.6 in-lbs. (1.2 Nm)



## REMINDER

Verify the lowest ambient temperature of the installation location. The rated Voc on the solar module nameplate is obtained at STC (Standard Testing Conditions = 77°F/25°C). As the ambient temperature drops, the solar module Voc increases. Please ensure the maximum solar string voltage, corrected at the lowest temperature, **does not exceed** the inverter's maximum input voltage of 480VDC.

PV Input Data	Description	Parameter
DC Input Voltage Range	Range required for the unit to operate up to max input	100–480VDC
Load Output Minimum Voltage	Minimum voltage needed to output power on load side	>140VDC
MPP Operating Voltage Range	Range where the MPPT can track	120–385VDC
Nominal MPPT Voltage	The MPPT will operate most optimally at this voltage	320VDC
Nominal MPPT Amperage	The MPPT will operate most optimally at this amperage	17A
Maximum MPPT Amperage	The MPPT can accept up to this amperage (clipping will occur past 17A)	25A
Maximum Utilized Solar Power	Wattage the unit can utilize from array after considering all power loss factors	8kW



**NOTE:** Each MPPT is rated for 4kW of solar input which leads to 8kW PV input in total. Size the PV strings accordingly for maximum gain.

## 5.5.2 STRING SIZING

When solar modules are put in a series string, the voltage multiplies times the number of modules and the amperage stays the same as each module.

**For example:** Using solar modules that have a 40VDC Voc (@77°F) with a Max Power amperage of 10 Amps (Imp) - 10 modules wired in a series string would have a Voc of 400VDC (@77°F) and a string amperage of 10 Amps. When the temperature lowers, the voltage can rise above the maximum allowed by the inverter and damage will result.



**CAUTION!** *To determine how many modules per string; first verify the lowest possible ambient temperature of the installation location. Next, find the rated Voc, Vmp, Isc and Imp of the solar module at 77°F and the temperature coefficients for voltage and power. Then, calculate highest possible Voc for the entire string when the ambient temperature falls to the lowest possible ambient temperature upon sunrise. To make this calculation, use a string calculator or consult a solar designer or solar electrician.*



**DANGER:** Damage WILL occur if the string voltage exceeds the inverter's maximum input voltage of 480VDC!

Finally, calculate the maximum current of the string (Isc) so as not to exceed the inverter's MPPT circuit ratings of 25A (see note at end of section). Double check if the calculated Vmp

range is within the 120-385VDC optimal MPPT circuit operating range. It is recommended to consult a solar designer for assistance.

**FOR ALL MODULES, THE CALCULATIONS NEED TO BE PERFORMED OR VERIFIED BY USING A STRING CALCULATOR OR CONSULTING A PROFESSIONAL.**

The inverter has two MPPT PV charging circuits. MPPT #1 and #2 will utilize up to 17 amps, which means two strings can be paralleled for any modules having less than 8.5A (I<sub>mp</sub>) rating.

When sizing strings for each MPPT, they **MUST** be the same model, brand and # per string (series and parallel).

All panels on a series/parallel string should face the same orientation and be exposed to roughly the same shading across the string. Consideration should be placed on string location and wiring order on the racking to minimize shading effects. One shaded module will disproportionately reduce the output of the entire string. This can be mitigated by avoiding linear strings in favor of rectangular strings, or using string optimizers.



**NOTE:** The array may have a higher I<sub>mp</sub> than the 17A specified, but the MPPTs may not make full use of the extra current which could lead to component deterioration over time. Do not exceed 25A or damage to the MPPT can occur.



**WARNING:** Please follow the steps listed below to ensure proper PV connections.

### 5.5.3 PV WIRING INSTRUCTIONS

**Step 1:** Before installing PV wiring into the inverter, please ensure all breakers and disconnects are open (off) and confirm the PV strings are not energized by using a multimeter to ensure there is no DC voltage on the lines. Once that has been verified, please proceed to step 2.

**Step 2:** Strip off 1/4 - 5/16 in. (6 – 8mm) insulation from the PV strings' positive and negative conductors.



**NOTE:** If using fine stranded wire, use ferrules to secure the connections to the inverter

**Step 3:** Insert the conduit fitting into the openings for the PV connections and tighten from the inside using the counter nut.

**Step 4:** Route the PV conductors through the conduit fitting and into the inverter.

**Step 5:** Secure the PV conductors in place into their respective terminals and torque to 10.6 in-lbs. (1.2 Nm). Verify the cables are secure by lightly tugging on them.

**Step 6:** Ensure the conduit and conduit fittings are fastened reliably, and the cable entry holes are sealed.



**NOTE:** All exposed metal parts of the system must be grounded regardless of voltage, including solar panel frames.

***DO NOT GROUND NEGATIVE PV LINES, ONLY SOLAR PANEL FRAMES!***



Please see diagram below for PV terminal labeling:

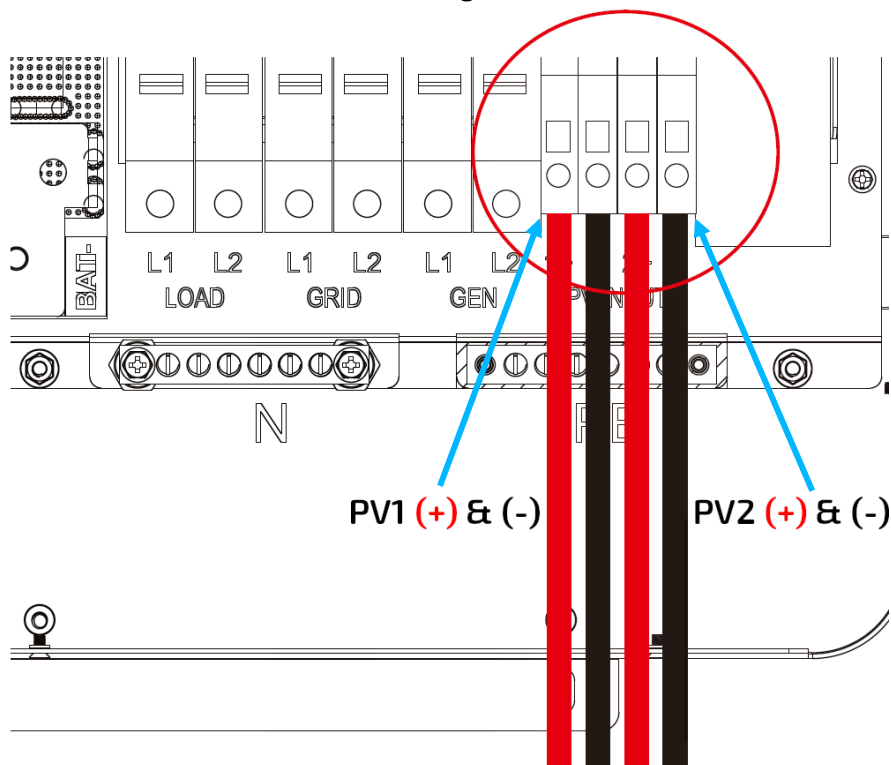

## 5.6 BATTERY CONNECTION

The EG4 6000XP can utilize either lithium or lead-acid batteries. There is a combination of settings that need to be configured depending on the battery type.

### 5.6.1 BATTERY CABLE CONNECTION

Follow the steps below to properly connect the battery wires.

**Step 1:** Place all breakers in the open (off) position before connecting or disconnecting wires. Ensure that there is no DC voltage present with a voltmeter.

**Step 2:** Assemble battery ring terminal based on recommended battery cable and terminal size (see table below).

**Step 3:** Connect all batteries as the unit requires.

**Step 4:** Connect the positive battery cable (Red) to the positive battery terminal (BAT+) and the negative battery cable (Black) to the negative battery terminal (BAT-) with a torque rating of  $\approx 97 - 106$  in-lbs. (11 – 12 Nm) per connection.

**Be sure not to cross-polarize, as this will damage the equipment!**

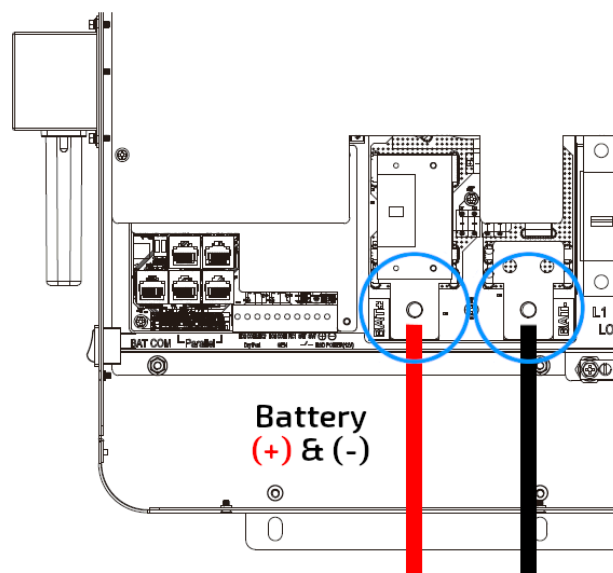

**NOTE:** If using a battery rack, ensure that all battery connections are installed properly before proceeding. Please refer to battery manual for more information.

The recommended battery cable and terminal size are as follows:

Maximum Amperage	Battery Capacity	Wire Size	Ring Terminal			Torque Value	Terminal Temperature Rating
			Cable (mm <sup>2</sup> )	Dimensions			
				Depth	Length		
140A*	≥200AH	1 AWG	38	.25 in. (6.4mm)	1.5 in. (39.2mm)	97 – 106 in-lbs. (11 – 12 Nm)	-40 - +248°F (-40° - +120°C)

\*Charging Current: 115A @48VDC (AC), 125A @48VDC (PV)

\*Discharging Current: 140A

## 5.6.2 LITHIUM BATTERY COMMUNICATIONS

Upon successful installation of the batteries, follow the next steps to enable closed-loop



**NOTE:** The recommended battery capacity of one 6000XP inverter is ≥200AH

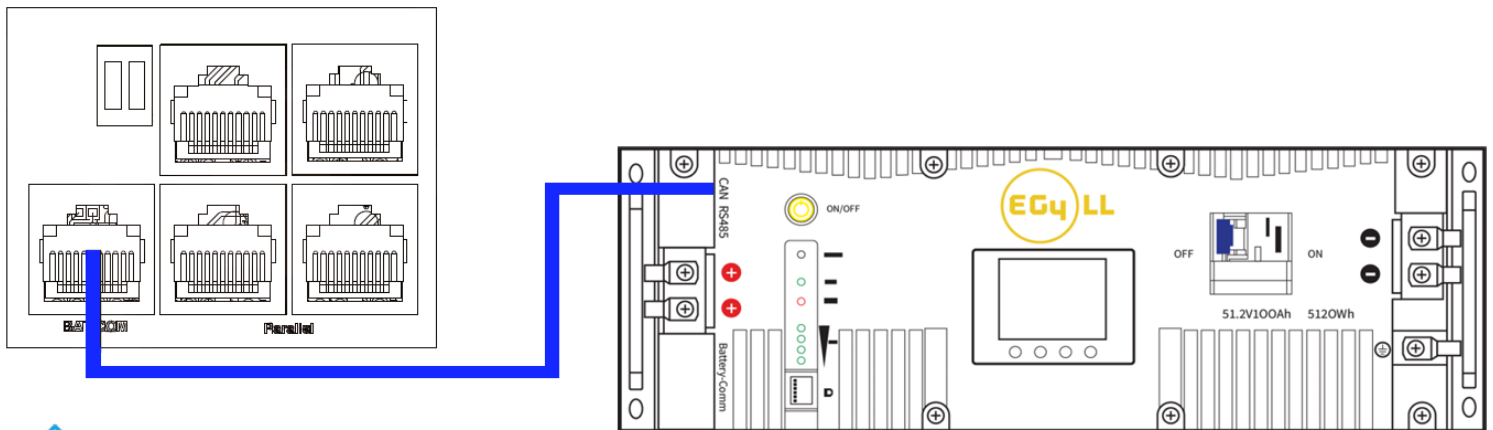

**ATTENTION:** If attempting to BMS communicate with EG4 LifePower4 batteries, an optional firmware update may need to be performed on the batteries.

communications (with compatible battery modules) between batteries and inverter:

1. Connect either the CAN or RS485 (depending on make/model of battery) communications cable between inverter and battery. See diagram below.
2. For the inverter to communicate with the battery BMS, setting 3 must be changed to “Li-ion”. The inverter will then switch to a secondary setting. Here, select the make/model of battery and press enter to register the change. For EG4 batteries, select “0” after confirming “Li-ion” as the battery type.



**NOTE:** If needing to extend the inverter to battery communication cable, or to build a new one, please refer to the following table for the inverter pinout descriptions.

For battery specific pinouts, please refer to the respective battery user manual.

PIN #		1	2	3	4	5	6	7	8
CAN	Pin	X	X	X	BMS_CAN H	BMS_CAN L	X	X	X
RS485	Description	BMS_485 B	BMS_485 A	X	X	X			

## 5.7 AC WIRING INFORMATION

When sizing AC wires, please adhere to the following information:

Terminal Connection	Wire Size	Torque Values
GRID	8 AWG (10mm <sup>2</sup> )	18 in-lbs. (2 Nm)
GEN	8 AWG (10mm <sup>2</sup> )	18 in-lbs. (2 Nm)
LOAD	8 AWG (10mm <sup>2</sup> )	18 in-lbs. (2 Nm)

### Ground-Neutral Bonding

The information below describes the nature of the ground and neutral in the inverter and their relationship to the system. Always consult with the installer or a licensed electrician to ensure that the right configuration is being used:

- The neutral line is a solid connection between AC input and AC output (known as a Common Neutral Architecture).
- The neutral line between the AC input and AC output is never disconnected.
- This architecture assumes there is a single neutral-ground bond in the system. Typically, the neutral-ground bond for a system will be at the first means of disconnect for the grid. However, if there is no neutral-ground bond in the system, the 6000XP can be configured to create the bond internally (see *setting 26*).



**WARNING:** This is not a dynamic bond. It is either always enabled or always disabled.



**NOTE:** Always be sure to connect the AC Output ground wire to the Ground terminal bus (labeled PE in the diagram) first before installing AC Outputs L1 and L2.

### 5.7.1 STEPS FOR AC CONNECTION

Please follow the steps outlined below to ensure proper AC Input/Output connections.

**Step 1:** Before installation of **any** wiring, please ensure all breakers are open (off) before making any connections. Use a multimeter to confirm the AC input lines (L1, L2 and neutral) are not energized.

**Step 2:** Strip off 5/16-3/8 in. (8-10 mm) insulation from the AC cables.

**Step 3:** Fasten the AC input wires into their respective terminals

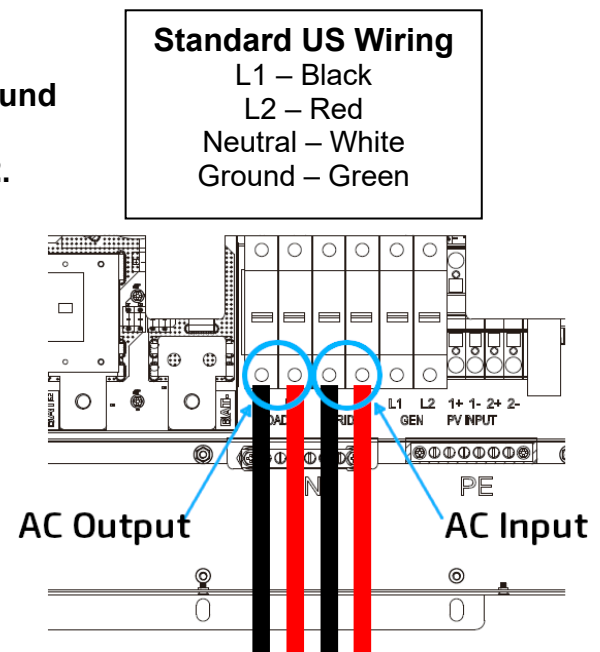

**NOTE:** After connecting all AC wiring, put the built-in LOAD breaker back to the ON position before providing power to the load.

## 5.8 WORKING WITH A GENERATOR

The EG4 6000XP can utilize a generator for backup power in the case of Grid failure. When sizing generators to provide both adequate power and frequency, keep in mind that the THD (Total Harmonic Distortion) of the generator must be <3%. It is a good rule of thumb to size the generator for **at least** 1.5x the output of the inverter to allow for powering loads and charging batteries. The table listed below shows the recommended generator capacity for optimal operations.

Number of Inverters in Parallel	Generator Capacity
1	>10kW
2	>15kW
3	>20kW
4	>25kW

When properly wired and configured, the generator, if compatible with remote start, will start automatically when the battery voltage/SOC is lower than the cut-off value or there is a charge request from the BMS. When the generator is running, it will charge the batteries and excess AC power will be diverted to the AC output (LOAD) to power loads. The pass-through relay on the inverter's generator terminal (GEN) is 50A. When the generator is on, please ensure the total load and charge current does not exceed 50A.

### 5.8.1 INTEGRATED TWO-WIRE START/STOP

This inverter has 2 two-wire start/stop contact connections that can be used to remotely enable external devices such as a generator. The Dry Port (NO2, COM2) can be used to remotely enable an external device when the battery voltage reaches a pre-set warning level. Similarly, the GEN Port (NO1, COM1) can be used to remotely start a generator. To do so, the generator start signal must be connected to the inverter GEN contacts, NO1 and COM1.





#### REMINDER:

NO = Normally Open, COM = Common

Dry Port and GEN relay maximum specification: 250VAC, 5A

The following table shows the ports' status under various system conditions.

Inverter Status	Condition		Dry Port Status	GEN Port Status
				
Power Off	Inverter is off and no output is powered		Open	Open
Power On	Without Grid	Battery Voltage/SOC < Generator Charge Start Voltage/SOC	Closed	Closed
		Battery Voltage/SOC > Generator Charge Stop Voltage/SOC	Open	Open
	With Grid	Battery Voltage/SOC < Generator Charge Start Voltage/SOC	Closed	Open
		Battery Voltage/SOC > Generator Charge Stop Voltage/SOC	Open	Open



**NOTE:** If running more than one inverter in the system, the generator must be wired to provide power to every inverter running in parallel for the inverters to function as intended.

## 5.8.2 GENERATOR AC CONNECTIONS

Please follow the steps listed below to ensure the generator connections are properly installed.

**Step 1:** Before making any wiring connections, be sure to have the inverter(s) powered off, the generator powered off, and all circuit breakers open (off) to prevent damage to the unit.

**Step 2:** Properly identify the generator's output lines. By US wiring standards, L1 wire will be black, L2 will be red, Neutral will be white, and ground will be green. Once identified, remove  $\approx 3/8$  in. ( $\approx 10$ mm) from the insulation sleeve on the wires.

**Step 3:** Ground the generator's output ground to the Ground Bus (labelled PE) of the inverter.

**Step 4:** Install L1 to the GEN port's L1 terminal, then install L2 to the GEN port's L2 terminal. Next, fasten the Neutral wire from the generator into the N-BUS (Neutral Bus).

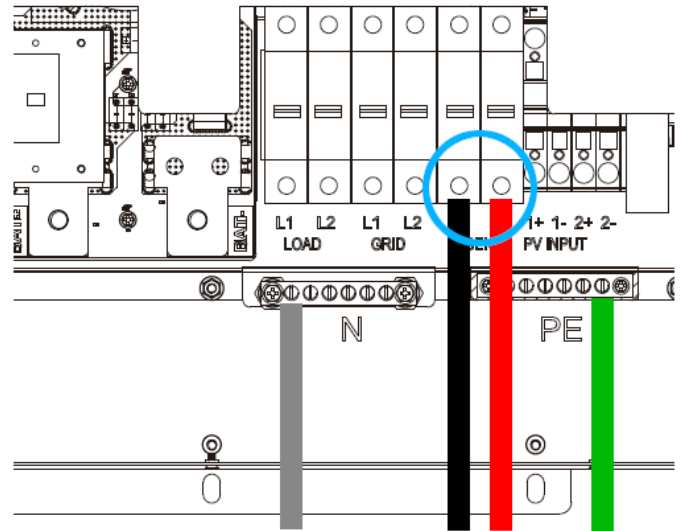

## 5.9 GENERATOR START AND STOP SETTINGS

Using the EG4 Monitoring Software, go to the “Maintenance” page where “Remote Set” will be selected automatically. Scroll to the “Generator Charge” section and select the “Generator Charge Type” (see screenshot below). Normally, lead-acid batteries are charged according to voltage and Lithium batteries are charged according to SOC.

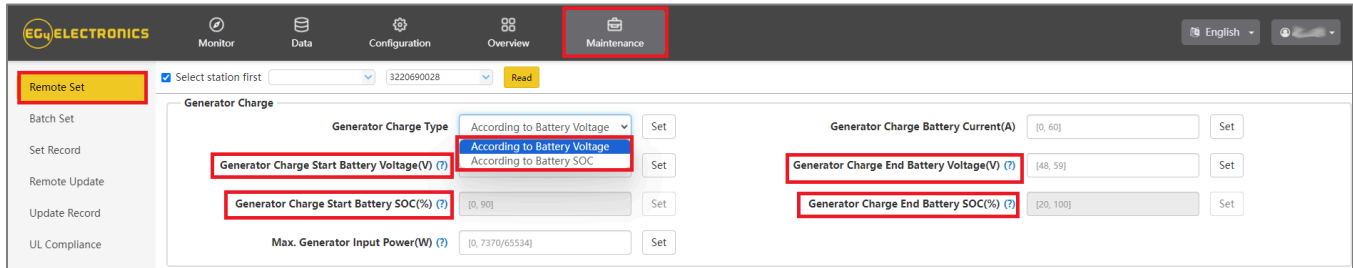

### Generator Start Conditions:

The generator will start when utility fails and one of the following conditions is met:

- The battery is discharged to the cut-off setting or
- There is a force charge request from battery or
- The battery voltage or SOC is lower than the “**Generator Charge Start Battery Volt/SOC**” setting

### Generator Stop Conditions:

When battery voltage or SOC is higher than the “**Generator Charge End Battery Volt/SOC**” settings.

## 5.10 OFF-GRID

The 6000XP Inverter can fully function in off-grid only mode. It does not need the utility or generator to function. Purely off-grid systems that do not have access to the utility should strongly consider having a 2-wire start backup generator for extended cloudy periods (8-12 kW diesel recommended per 6000XP - 8kW *minimum* per inverter). Off-Grid systems should have robust battery banks sized to ensure multiple days of power and to reduce generator run time.

## 5.10.1 OFF-GRID WIRING

The 6000XP can accept up to 50 Amps (12kW) of generator power and will pass through all available power to the loads. Therefore, the loads subpanel can be sized up to the size of the backup generator with 50 Amps minimum per inverter.

## 5.11 PARALLELING INFORMATION

### 5.11.1 PARALLEL COMMUNICATION CONNECTIONS

The EG4 6000XP inverter supports parallel connections to expand power and energy capacity to suit different usage scenarios. **Up to 16 units can be paralleled to reach a capacity of up to 96kW.** The parallel communication wiring diagrams are shown below. The bypass switch connects the loads to LOAD panel by default. If the inverters fail, users can switch the loads to utility. **Please contact the inverter supplier for more detailed guidance on paralleling systems.**



**REMINDER:** Put the CAN communication PIN to ON status for the first and the last inverter and OFF for inverters in between. Both switches in the “ON” position translates to address 1. Both switches in the “OFF” position translates to address 0.

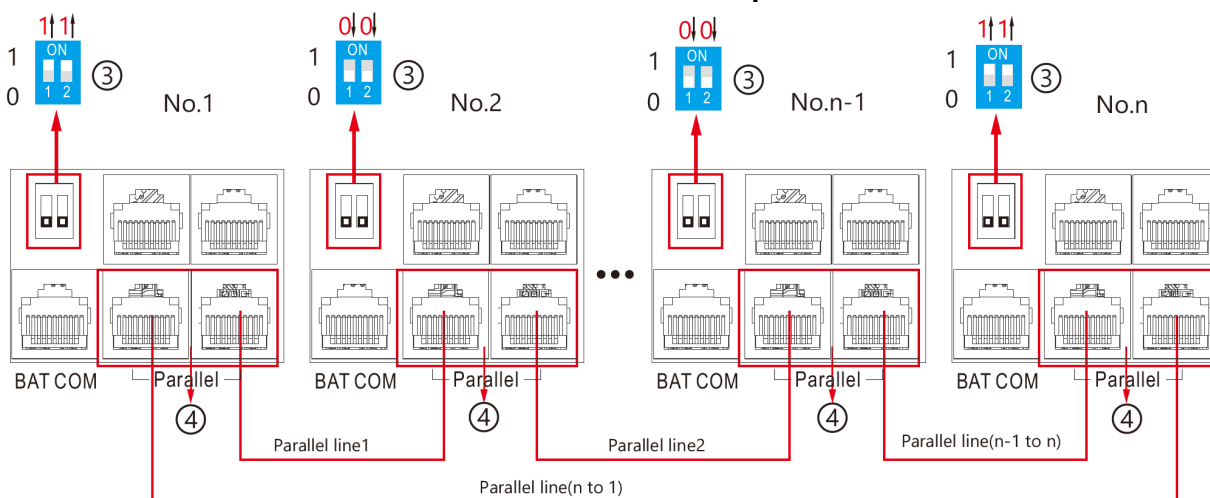

**REMINDER:** If needing to extend the inverter-to-inverter paralleling cable, ensure the cable is a straight-through CAT5 and up cable. See image below for reference.

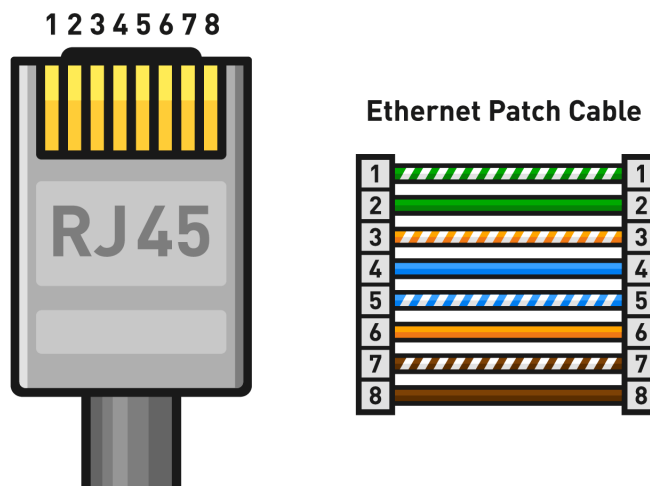

Please contact your inverter supplier for more detailed guidance on paralleling a system.

## 5.11.2 PARALLEL CONFIGURATION

### Important notices for parallel system:

- If utilizing the generator input (GEN), ensure that the generator is connected to all inverters in parallel.
- If it is not possible to evenly divide solar strings per inverter, it is recommended to have more PV strings on the master inverter.
- The values shown on the LCD of each inverter displays the individual inverter's contribution to the system, **not the system's total**.

### Before commissioning:

1. Verify that all inverters in the system are updated to the latest firmware. Please contact the distributor to confirm the latest version.
2. Make sure the power cables and parallel communications cables have been wired correctly and verify the DIP-switch settings are correct.
3. Ensure the LOAD breakers are off (open). Ensure there is no AC voltage present with a multimeter before proceeding to the next step.
4. Power on the inverters.
5. Navigate to setting 21 to configure phasing.
6. Starting with the master inverter (the inverter communicating with the battery bank), change setting 21 to 1PH for split-phase parallel. The LCD will then switch to a secondary setting, Parallel Phase. Set the inverter to P1 for phase 1. Repeat this step for all paralleled inverters.
7. Enable **"Battery Shared"** on all inverters in parallel.
8. Ensure all inverters are set to **"P1"** phase.
9. Ensure the battery to inverter communications cable is properly connected from master battery to inverter.



**NOTE: If commissioning a single inverter system, ensure setting 21 is set to NoPL (no parallel), then finish the commissioning**

### **Commissioning Steps:**

1. Power on the system per the start-up sequence outlined in section 13.
2. Turn on the battery and make sure the communication works on all units.
3. Check the parallel info via the Home page on the LCD.
4. Before connecting loads to the load output terminal, check the output of L1 to N, L2 to N and L1 to L2 to ensure there is no voltage present.
5. Add some small loads to the load output and verify power output.
6. Perform a full system restart as outlined in section 13 to finish the commissioning.



**NOTE: To determine proper host and slave definition of the inverters, provide power to each before turning on. Turn on the EPS Output (AC Output) on the host inverter first, to designate it as host. Power on each inverter paralleled past the host to define them as slaves. On the main inverter display, press "down" three times, then check the numbers & letters in the top left. Host inverter should read "1P-H:P1: 1", and slave should read "1P-S:P1: "X"", with the "X" representing the number of inverters in parallel.**

## 6. END USER SETTINGS

The EG4 Monitor Software can be used to configure the desired functionality of the 6000XP Inverter. The following sections describe the different fields in the Monitor Software GUI and their definitions for those with an end-user account.

### 6.1 APPLICATION SETTING

- **EPS Voltage Set(V):** Set the voltage of the inverter’s output.
- **EPS Frequency Set(Hz):** Set the frequency of the inverter’s output.

#### AC First

- **AC first Start Time 1, 2, 3:** Set the start time for when inverter passes through from grid to loads.
- **AC first End Time 1, 2, 3:** Set the end time for when inverter passes through from grid to loads.

### 6.2 CHARGE SETTING

- **Charge Current Limit(A):** The maximum charge current limitation of the entire system in DC Amps.

#### Lead-Acid

- **Charge Voltage(V):** Set bulk charging voltage for lead-acid batteries.

#### AC Charge

- **AC Charge:** Utility charge configuration. If users want to use grid power to charge their battery, they can enable ‘AC Charge’. Configure setting by Time, Voltage, SOC, Time &



Voltage or Time & SOC. Up to 3 timeslots can be configured via the AC Charge Start Time 1, 2 and 3 settings shown above.

- **AC Charge Battery Current(A):** Set AC Charge Current limit for grid to batteries.
- **AC Charge Start Battery Voltage(V):** Begin charging from grid when batteries reach this voltage. (If set to charge by Voltage)
- **AC Charge End Battery Voltage(V):** Stop charging from grid when batteries reach this voltage. (If set to charge by Voltage)
- **AC Charge Start Battery SOC(%):** Begin charging from grid when batteries reach this SOC%. (If set to charge by SOC)
- **AC Charge End Battery SOC(%):** Stop charging from grid when batteries reach this SOC%. (If set to charge by SOC)

## 6.2.1 GENERATOR CHARGE

- **Generator Charge Type:** Set generator charge type by either Voltage or SOC%.
- **Generator Charge Battery Current(A):** Set maximum amperage charge from generator.
- **Generator Charge Start Battery Voltage(V):** Set Voltage which generator will start charging batteries.
- **Generator Charge End Battery Voltage(V):** Set Voltage which generator will stop charging batteries.
- **Generator Charge Start Battery SOC(%):** Set SOC% which generator will start charging batteries.
- **Generator Charge End Battery SOC(%):** Set SOC% which generator will stop charging batteries.
- **Max. Generator Input Power(W):** Set the maximum power(W) the inverter will pull from generator for charging.

## 6.3 DISCHARGE SETTING

▼ Discharge Setting

Discharge Control (?) <span style="border: 1px solid #ccc; padding: 2px;">According to SOC</span> <span style="border: 1px solid #ccc; padding: 2px;">Set</span>	Discharge Current Limit(Adc) (?) <span style="border: 1px solid #ccc; padding: 2px;">140</span> <span style="border: 1px solid #ccc; padding: 2px;">Set</span>
Discharge Cut-off Voltage(V) (?) <span style="border: 1px solid #ccc; padding: 2px;">42</span> <span style="border: 1px solid #ccc; padding: 2px;">Set</span>	Discharge Cut-off SOC(%) (?) <span style="border: 1px solid #ccc; padding: 2px;">15</span> <span style="border: 1px solid #ccc; padding: 2px;">Set</span>
On Grid EOD Voltage(V) (?) <span style="border: 1px solid #ccc; padding: 2px;">42</span> <span style="border: 1px solid #ccc; padding: 2px;">Set</span>	On Grid EOD SOC(%) (?) <span style="border: 1px solid #ccc; padding: 2px;">15</span> <span style="border: 1px solid #ccc; padding: 2px;">Set</span>

- **Discharge Control:** Set Voltage/SOC to configure stop time for battery discharge.
- **Discharge Current Limit(Adc):** Set the limit of battery discharge current.
- **Discharge Cut-off Voltage(V)/SOC(%):** Set when batteries stop discharging to power loads via Voltage/SOC.
- **On Grid EOD Voltage(V)/SOC(%):** Set when batteries stop discharging to power loads via Voltage/SOC and switch to have AC power loads/charge batteries. When battery voltage is > (EOD Voltage +3V), the inverter will switch back to battery discharge mode. When battery SOC is > (EOD SOC+10%), the inverter will switch back to battery discharge mode.

## 6.4 RESET

▼ Reset

All to Default Reset

- **Reset:** Reset all settings to factory default. Be sure to keep track of what changes need to be made before powering the system back on!

## 7. INSTALLER SETTINGS

The EG4 Monitor Software can be used to configure the desired functionality of the 6000XP Inverter. The following sections describe the different fields in the Monitor Software GUI and their definitions for those with Installer account access.

The screenshot shows the 'Common Setting' window in the EG4 Monitor Software. It contains several configuration options:

- Time (?):** A text input field with a 'Set' button next to it.
- PV Input Mode:** A dropdown menu currently set to '0: DC source mode' with a 'Set' button.
- Battery Type (?):** A dropdown menu.
- Lead-acid Capacity:** A dropdown menu.
- Lithium Type:** A dropdown menu with a 'Set' button.
- Green Function Enable (?):** Two buttons: 'Enable' and 'Disable'.
- Battery ECO Enable (?):** Two buttons: 'Enable' and 'Disable'.
- Buzzer Enable:** Two buttons: 'Enable' and 'Disable'.
- ISO Enable:** Two buttons: 'Enable' and 'Disable'.
- Normal / Standby (?):** Two buttons: 'Normal' and 'Standby'.
- Restart Inverter:** A 'Reset' button.

### 7.1 COMMON SETTING

- **Time:** This is the local date and time.
- **PV Input Mode:** This allows the user to select the PV source for the Inverter. This can be: 0: DC source mode, 3: Two MPPT connects to same string, or 4: Two MPPT connects to different string.
- **Battery Type:** The type of battery being used. Can be set to - 0: No Battery, 1: Lead-acid, or 2: Lithium.



**REMINDER:** It is not recommended to run the system without battery backup.

- **Lead-acid Capacity:** Select the total battery capacity for lead-acid banks.
- **Lithium Type:** This setting allows the user to select from a list of compatible batteries for closed-loop communications.
- **Green Function Enable:** When enabled, if the inverter load reading is less than 60W for more than 10 minutes, the inverter output will be cut off.
- **Normal / Standby:** Select Normal for the inverter to operate normally. Select Standby to halt all power input and output.
- **Restart Inverter:** This restarts the inverter.
- **Battery ECO Enable:** When enabled, the inverter will switch to bypass mode if the battery has reached the On-Grid EOD value and AC charging is disabled. The inverter will stay in bypass mode until the battery is being charged again. Switch time can be up to 15ms.
- **Buzzer Enable:** Enable/disable the alarm buzzer.
- **ISO Enable:** Enable/disable PV ground fault circuit interrupter.

The screenshot shows the 'Application Setting' interface with the following controls:

- EPS Voltage Set(V) (?)**: 200/100 (dropdown), Set button
- EPS Frequency Set(Hz) (?)**: <Empty> (dropdown), Set button
- AC Input Range (?)**: <Empty> (dropdown), Set button
- PV Grid Off (?)**: Enable, Disable buttons
- PV Arc**: Enable, Disable buttons
- PV Arc Fault Clear**: Clear button
- RSD**: Enable, Disable buttons
- N-PE Connect (Inner)**: Enable, Disable buttons
- AC First (?)** section:
  - AC first Start Time 1-3**: Each has a [0, 23] : [0, 59] range and a Set button.
  - AC first End Time 1-3**: Each has a [0, 23] : [0, 59] range and a Set button.
- Parallel Settings** section:
  - Set System Type (?)**: <Empty> (dropdown), Set button
  - Battery Shared (?)**: Enable, Disable buttons



**NOTE:** The user must also establish the paralleling scheme using Setting 21 in the user interface. ‘NoPL’ (Not Parallel) or ‘1PH’ (Single Phase). See Section 12, LCD Settings, for more details.

## 7.2 APPLICATION SETTING

- **EPS Voltage Set(V):** Set the inverter’s output voltage.
- **EPS Frequency Set(Hz):** Set the inverter’s output frequency.
- **AC Input Range:** Set the voltage range for AC Input.
- **PV Grid Off:** If the customer wants the system to have Off-Grid functionality without having battery backup, please enable PV Grid Off. Note that in this situation the AC Output power is supplied by solar and is not stable due to fluctuating voltages from the solar modules. We suggest the customer install battery/batteries to keep the inverter output voltage stable if they want to have Off-Grid function. (Allows system to access the Off-Grid mode when only solar input is available without battery storage).
- **PV Arc:** Enables detection of arcs on the PV input circuits to the inverter and provides protection from PV circuit arcs.
- **PV Arc Fault Clear:** Clears any fault detected due to arcs on the PV input circuit to the inverter.
- **RSD:** Enables the Rapid Shut Down feature.
- **N-PE Connect (Inner):** Enable for the AC Neutral (N) and AC Ground (PE) to be bonded.

### AC First

- **AC first Start Time 1-3:** The time at which the Inverter will use only AC to power loads. The range is 00:00 to 23:59.
- **AC first Stop Time 1-3:** The time at which the Inverter will use only AC to power loads. The range is 00:00 to 23:59.

### Parallel Settings

- **Set System Type:** The EG4 6000XP supports paralleling of multiple inverters.
- **Battery Shared:** For paralleled systems, if all inverters connect to same battery bank, Battery Shared must be enabled. The inverter with battery to inverter communication cable connected will broadcast the battery info to all other inverters.

## 7.3 CHARGE SETTING

- **Charge Current Limit(Adc):** The maximum charge current limitation of the entire system in DC Amps.

### Lead Acid

- **Charge Voltage(V):** Set this according to the battery requirements. Range is 50-59VDC.
- **Floating Voltage(V):** Set this according to the battery requirements. Range is 50-56VDC. When using lead-acid batteries, this must be set lower than the 'Charge Voltage' above. When using lithium batteries in lead-acid mode, this can be set  $\leq$  'Charge Voltage' above.
- **Equalization Voltage(V):** Range is 50-59VDC for lead-acid batteries. When using Lithium batteries in lead-acid mode, this should be set to 0 (zero).
- **Equalization Period(Days):** Range is 0-365 days for lead-acid batteries. When using Lithium batteries in lead-acid mode, this should be set to 0 (zero).
- **Equalization Time(Hours):** Range is 0-24 hours for lead-acid batteries. When using Lithium batteries in lead-acid mode, this should be set to 0 (zero).

### AC Charge

- **AC Charge Based On:** If using AC to charge the battery; the customer must first select the method of charging. This can be set to charge by "Time", "Voltage", "SOC", "Battery Voltage and Time" or "Battery SOC and Time".
- **AC Charge Battery Current(A):** Set this according to the battery requirements. Range is 0-100 Amps.
- **AC Charge Start Time 1-3:** Start AC Charging according to these time settings.
- **AC Charge End Time 1-3:** Stop AC Charging according to these time settings.
- **AC Charge Start Battery Voltage(V):** Battery Voltage at which system will start charging batteries from AC. Set this according to the battery requirements. Range is 38.4-57VDC.
- **AC Charge End Battery Voltage(V):** Battery Voltage at which system will stop charging batteries from AC. Set this according to the battery requirements. Range is 48-59VDC.
- **AC Charge Start Battery SOC(%):** Battery% SOC at which system will start charging batteries from AC. Set this according to the battery requirements. Range is 0-90%.
- **AC Charge End Battery SOC(%):** Battery% SOC at which system will stop charging batteries from AC. Set this according to the battery requirements. Range is 20-100%.

## Generator Charge

- **Generator Charge Type:** Set generator charging according to Battery Voltage or Battery SOC.
- **Generator Charge Battery Current(A):** Set generator battery charging current. Range is 0-60 Amps.
- **Generator Charge Start Battery Voltage(V):** Battery Voltage at which system will start charging batteries from the generator. Set this according to the battery requirements. Range is 38.4-57VDC.
- **Generator Charge End Battery Voltage(V):** Battery Voltage at which system will stop charging batteries from the generator. Set this according to the battery requirements. Range is 48-59VDC.
- **Generator Charge Start Battery SOC(%):** Battery% SOC at which system will start charging batteries from the generator. Set this according to the battery requirements. Range is 0-90%.
- **Generator Charge End Battery SOC(%):** Battery% SOC at which system will stop charging batteries from the generator. Set this according to the battery requirements. Range is 20-100%.
- **Max. Generator Input Power(W):** The inverter will limit the power from the generator to 90% of the total generator capability to prevent overloading. Range is 0-7,370 Watts for a single inverter and 0-65,534 Watts for parallel inverters.
- **Generator Boost:** When enabled, the inverter will pull supplemental power from both PV and battery whenever the generator power is not sufficient to handle the loads.

## 7.4 DISCHARGE SETTING

Discharge Setting

Discharge Control (?) <span style="border: 1px solid #ccc; padding: 2px;">According to Voltage</span> <span style="float: right; border: 1px solid #ccc; padding: 2px;">Set</span>	Discharge Current Limit(Adc) (?) <span style="border: 1px solid #ccc; padding: 2px;">[0, 110/4480]</span> <span style="float: right; border: 1px solid #ccc; padding: 2px;">Set</span>
Battery Warning Voltage(V) (?) <span style="border: 1px solid #ccc; padding: 2px;">[40, 50]</span> <span style="float: right; border: 1px solid #ccc; padding: 2px;">Set</span>	Battery Warning SOC(%) (?) <span style="border: 1px solid #ccc; padding: 2px;">[0, 90]</span> <span style="float: right; border: 1px solid #ccc; padding: 2px;">Set</span>
Discharge Cut-off Voltage(V) (?) <span style="border: 1px solid #ccc; padding: 2px;">[40, 50]</span> <span style="float: right; border: 1px solid #ccc; padding: 2px;">Set</span>	Discharge Cut-off SOC(%) (?) <span style="border: 1px solid #ccc; padding: 2px;">[0, 90]</span> <span style="float: right; border: 1px solid #ccc; padding: 2px;">Set</span>
On Grid EOD Voltage(V) (?) <span style="border: 1px solid #ccc; padding: 2px;">[40, 56]</span> <span style="float: right; border: 1px solid #ccc; padding: 2px;">Set</span>	On Grid EOD SOC(%) (?) <span style="border: 1px solid #ccc; padding: 2px;">[0, 90]</span> <span style="float: right; border: 1px solid #ccc; padding: 2px;">Set</span>

- **Discharge Control:** Set to 'According to Voltage' when using a lead-acid battery or a lithium battery in lead-acid mode. Set to 'According to SOC' when using a compatible lithium battery.
- **Discharge Current Limit(Adc):** Set this according to the battery requirements. Range is 1-110 Amps for a single battery and 1-4480 Amps for paralleled batteries.
- **Battery Warning Voltage(V):** Set this according to the battery requirements. The inverter will display a battery low warning when the battery voltage falls to this value. Range is 40-56VDC.
- **Battery Warning SOC(%):** Set this according to the battery requirements. The inverter will display a battery low warning when the battery SOC falls to this value. Range is 0-90%.
- **Discharge Cut-off Voltage(V):** Set this according to the battery requirements. Range is 40-56VDC.
- **Discharge Cut-off SOC(%):** Set this according to the battery requirements. Range is 0-90%.

- **On Grid EOD Voltage(V):** The inverter will stop discharging the battery at this voltage and will use AC to power loads. When battery voltage is  $> (\text{EOD Voltage} + 3\text{V})$ , the inverter will switch back to battery discharge mode.
- **On Grid EOD SOC(%):** The inverter will stop discharging the battery at this SOC and will use AC to power loads. When battery SOC is  $> (\text{EOD SOC} + 10\%)$ , the inverter will switch back to battery discharge mode.

Other Setting

Batt Volt Sample Disable

Fan 1 Max Speed(%)   Fan 2 Max Speed(%)

## 7.5 OTHER SETTING

- **Batt Volt Sample Disable:** Set to Internal, External or Both Available.
- **Fan 1 Max Speed(%):** This sets cooling fan 1 max. speed. Range is 50-100%.
- **Fan 2 Max Speed(%):** This sets cooling fan 2 max. speed. Range is 50-100%.

## 7.6 RESET

Reset

- **All to Default:** This resets all settings to factory default values.



**NOTE:** Be sure to keep track of the settings and what changes need to be made before outputting power from the inverter

## 8. MONITOR SYSTEM SETUP

### 8.1 WI-FI/4G/LAN DONGLE CONNECTION

A Wi-Fi/4G/LAN dongle can be used to monitor the inverter and remotely view the monitoring data on a computer or smart phone. This module can be attached by plugging it in to the 'Wi-Fi' connector on the inverter and securing it with the 4 Phillips head screws. See section 10 for more details regarding dongle setup.

### 8.2 THIRD-PARTY RS485 COMMUNICATION

Meters 485B and 485A can be used when a meter is not connected. These two pins can be used to communicate with the inverter using the RS485 Modbus protocol.

INV485: This interface is shared with the Wi-Fi module. If the Wi-Fi module is not in use, this interface can be used to communicate with the inverter.

Please contact the distributor to get the Modbus protocol for third-party app development.

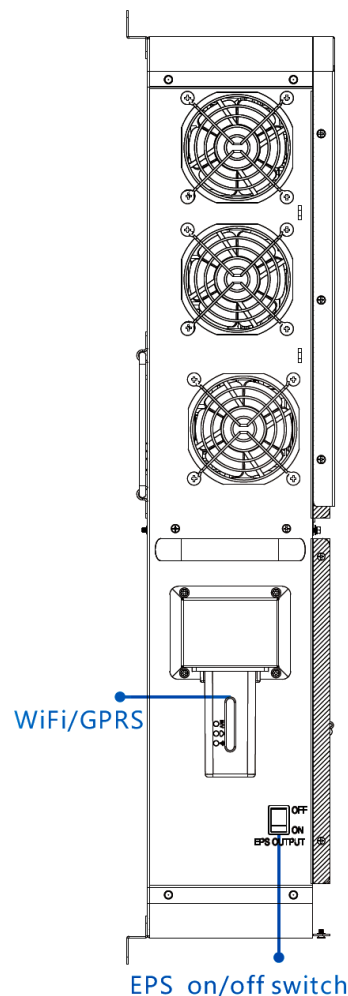

#### **View data on smart phone:**

A QR code with a link to our website with app installation steps can be found on the side of the inverter or visit our downloads page at [www.eg4electronics.com](http://www.eg4electronics.com) for more information.

## 8.3 ONLINE MONITORING SYSTEM USER INTERFACE

The customer needs to register a monitor account in the monitor system and set a Wi-Fi password for the Wi-Fi dongle before using the EG4 monitor system. The monitoring system may change due to updates, so the following UI descriptions may vary from the current pages on the site. Please contact [support@eg4electronics.com](mailto:support@eg4electronics.com) to create distributor or installer accounts. See section 10 for detailed instructions on how to access the EG4 Monitor App, how to register an account, and how to set a Wi-Fi password.

### 8.3.1 DASHBOARD (MONITOR TAB)

Once the account is created and the user is logged in, the main page (Monitor tab) of the interface will be displayed.

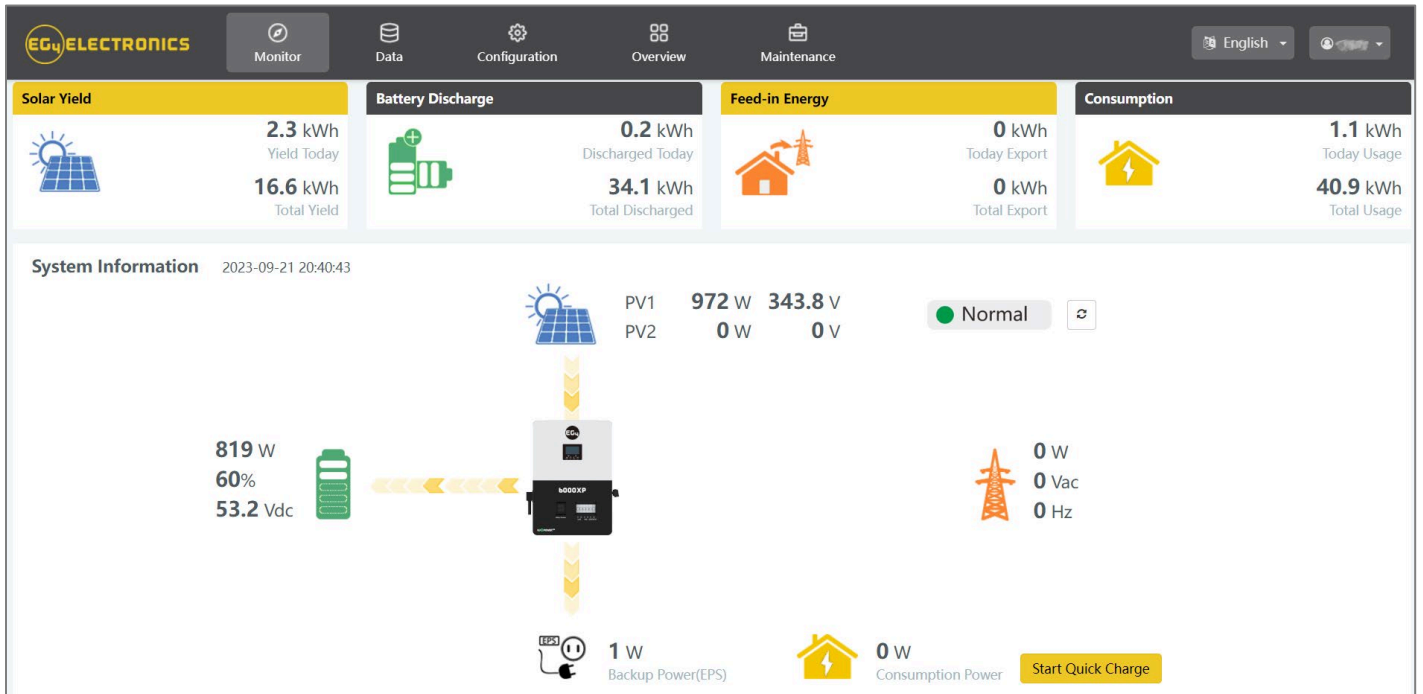



Name	Description
<b>Select station first</b>	<p>Select which station to view, and then select which unit/dongle to view by choosing a serial number from the dropdown list.</p> <p><b>Note:</b> Unchecking the box will only display serial numbers linked to the account.</p>
<b>Solar Yield</b>	<p>Shows power generated by the solar panels (for AC coupled inverters it shows the power generated by the on-grid inverter). The PV CT clamp will have to be installed to be able to show the data correctly. When the picture of the solar yielding is clicked, it will display how the solar energy has been used that day. A second click will show the totals since commissioning.</p>
<b>Battery Discharge</b>	<p>Shows the charge and discharge energy from the battery/batteries. When the battery picture is clicked, the display will switch between battery discharging and battery charging, showing totals for that day and since commissioning.</p>
<b>Consumption</b>	<p>Shows the total energy consumption of the property for that day and since commissioning.</p>
<b>System information</b>	<p>Displays power sources and energy flow, voltage, and amperage from lines to loads. Clicking the button beside the status will refresh the information to reflect real time data.</p> <p><b>Note:</b> When the battery's color is yellow or red it means there is a warning or fault with the battery.</p>
<b>GEN Quick Start</b>	<p>Send a start signal to the generator.</p>
<b>Start Quick Charge</b>	<p>Clicking this will direct the inverter to charge batteries faster for <b>one hour</b>. It will then default back to its original setting.</p>
<b>Language and User</b>	<p><b>English</b> – Clicking this will allow the user to change the language of the page.</p> <p><b>(Username)</b> – Clicking this will open a list with User Center (used for editing the profile), Modify password (used to change the account password), and Logout (to logout of this account)</p>

**Input & Output Power and Energy Overview can also be viewed via the Monitoring Software. See following page for examples.**



Name	Description
<b>Input Power</b>	This chart shows the power curve for each day, including solar power, battery charge/discharge power and grid import power and consumption. Hovering over an item name will highlight it in the chart. Clicking it will remove it from the list.
<b>Energy Overview</b>	This chart shows energy production and consumption for each day, including solar production, battery, and consumption. Hovering over an item name will highlight it in the chart. Clicking it will remove it from the list. Selecting 'Month' will show the energy statistics for each day. Selecting 'Year' will show energy for each month. Selecting 'Total' will show energy for each year.

## 8.3.2 DASHBOARD (DATA TAB)

The Data Tab displays additional detailed data including technical details for PV, battery, grid, and loads, that is helpful for analysis and maintenance.

Five categories make up the Data Tab view: "Chart", "Energy", "Data History", "Local data", and "Event History." For more details on each category, please see the following tables.

### Chart

Displays various parameters in chart format over a 24-hour period. There are separate charts for "PV Side", "Battery", "AC Side" and "Backup Output".

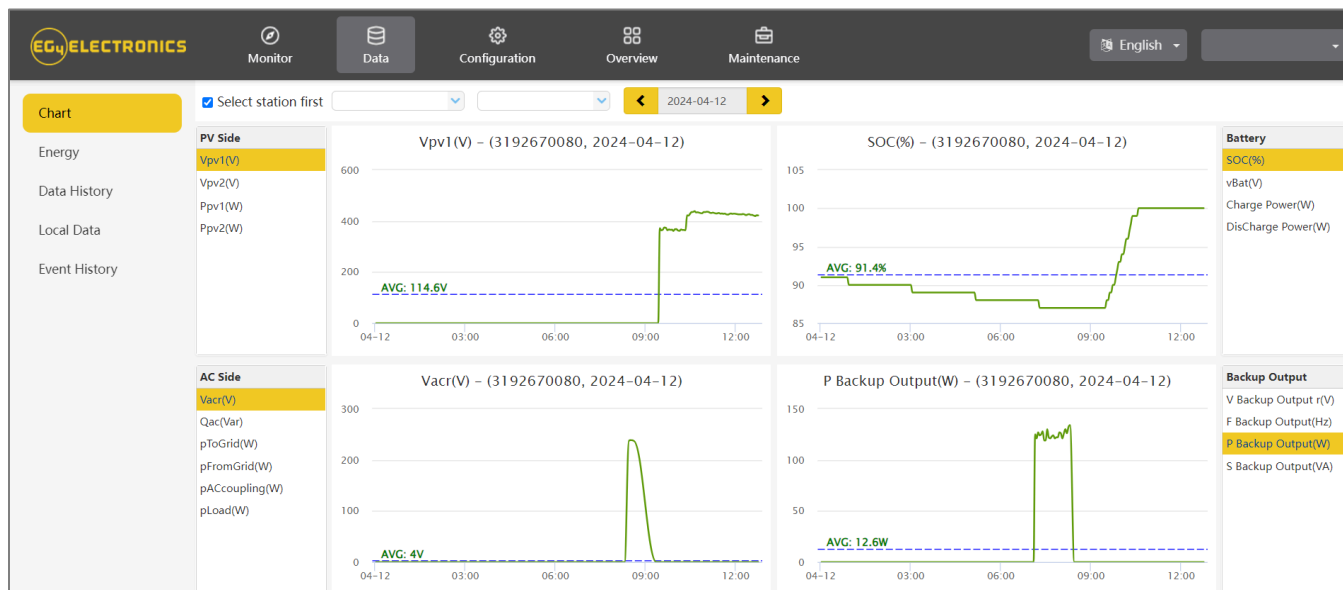

<b>Vpv 1-2 (V)</b>	Voltage of solar input
<b>Ppv 1-2 (W)</b>	Power of solar input
<b>SOC (%)</b>	Battery state of charge
<b>vBat (V)</b>	Battery voltage
<b>Charge Power (W)</b>	Battery charging power
<b>Discharge Power (W)</b>	Battery discharging power
<b>Vacr (V)</b>	Voltage of AC output
<b>pFromGrid (W)</b>	Power feed from grid to inverter
<b>V Backup Output r (V)</b>	Load rated voltage
<b>F Backup Output (Hz)</b>	Load frequency
<b>P Backup Output (W)</b>	Load output power
<b>S Backup Output (VA)</b>	Load apparent power

## Energy

Displays how key energy parameters have varied over time.

- Selecting 'Month' will show the energy statistics for each day.
- Selecting 'Year' will show energy for each month.
- Selecting 'Total' will show energy for each year.

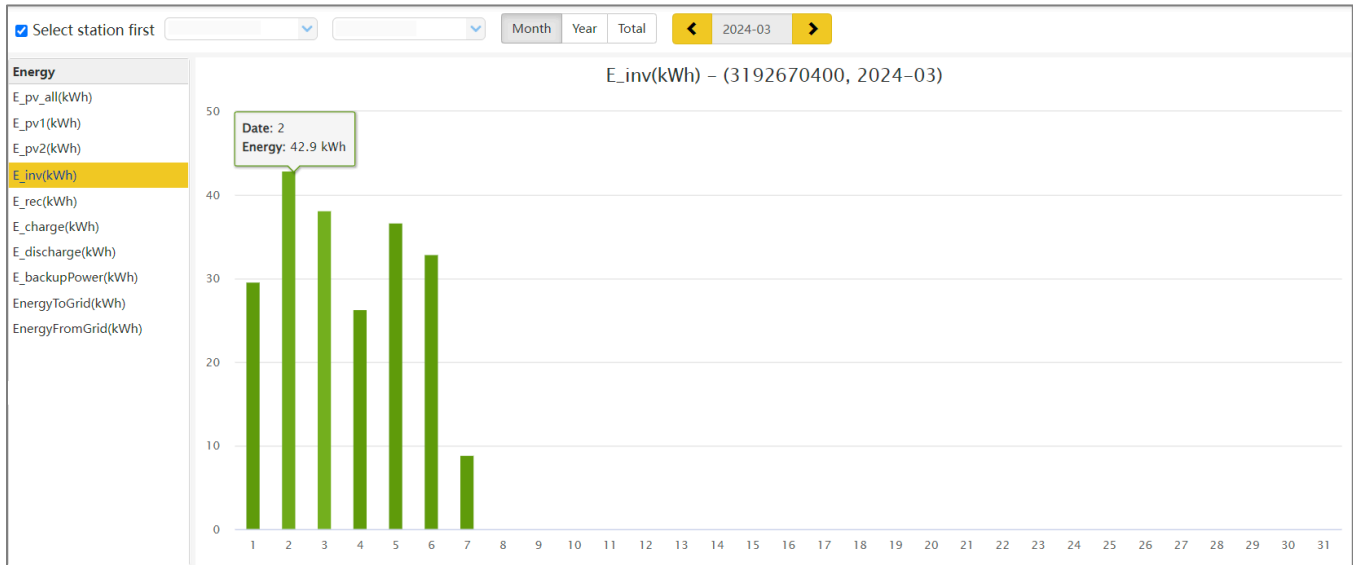

Name	Description
E_pv1(kWh)	Energy generated by PV string 1
E_pv2(kWh)	Energy generated by PV string 2
E_inv(kWh)	Energy output via AC output
E_rec(kWh)	Energy of AC charge
E_charge(kWh)	Energy used for battery charge
E_discharge(kWh)	Energy output by battery discharging
E_backupPower(kWh)	Load energy output
EnergyToUser(kWh)	Energy import from grid

## Data History

Displays the measured technical characteristics of PV, battery, load, and grid for users or their distributor's examination to promptly address any potential issues.

Advanced technical knowledge is necessary to properly comprehend this table. End users are advised to concentrate solely on the "Monitor" view, "Chart" and "Energy" sections as these only offer simple to comprehend performance data.



**HELPFUL TIP:** Data can be exported to an Excel file to provide to the distributor for technical support. Distributors can then analyze the following factors to perform quick troubleshooting for their end users.

Serial number	Time	Status	Vpv1(V)	Vpv2(V)	Vpv3(V)	vBat(V)	SOC(%)	Ppv1(W)	Ppv2(W)	Ppv3(W)	pCharge(%)	pDisCharge	Vacr(V)	Vacs(V)	Vact(V)	Fac(Hz)	Pinv(r)	Prec(r)	PF(r)	Veps(r)	Vepss(V)	Vepst(V)
1	2024-03-07 12:11:14	0x0C	345.8	4.1	5.3	53.3	66%	2073	0	0	1478	0	247.3	25.7	0.2	60.02	555	0	1	248.2	123.2	1546.6
2	2024-03-07 12:10:14	0x0C	348	4.1	5.4	53.3	66%	2142	0	0	1510	0	247.4	25.7	0.2	60.01	591	0	1	247.3	123.2	1546.6
3	2024-03-07 12:09:14	0x0C	345.5	4.1	5.3	53.3	66%	2174	0	0	1529	0	247.3	25.7	0.2	59.98	602	0	1	247.3	123.2	1546.6
4	2024-03-07 12:08:13	0x0C	345.9	4.1	5.3	53.2	66%	2151	0	0	1485	0	247.3	25.7	0.2	60.01	623	0	1	247.3	123.2	1546.6
5	2024-03-07 12:07:12	0x0C	344	4.3	5.2	53.2	66%	2050	0	0	1415	0	247.5	25.7	0.2	59.97	594	0	1	247.6	123.2	1546.6
6	2024-03-07 12:06:13	0x0C	346.5	4.3	5.2	53.2	66%	2032	0	0	1379	0	248.3	25.7	0.2	59.99	614	0	1	248.5	123.2	1546.6
7	2024-03-07 12:05:11	0x0C	344.9	4.1	5.2	53.2	66%	2049	0	0	1397	0	248.3	25.7	0.2	60	612	0	1	248.5	123.2	1546.6
8	2024-03-07 12:04:11	0x0C	347.3	4.1	5.2	53.2	66%	2034	0	0	1395	0	247.5	25.7	0.2	60.01	599	0	1	247.6	123.2	1546.6
9	2024-03-07 12:03:11	0x0C	344	4.3	5.2	53.2	66%	2023	0	0	1368	0	248.3	25.7	0.2	60	616	0	1	248.2	123.2	1546.6
10	2024-03-07 12:02:11	0x0C	344.5	4.2	5.2	53.1	66%	1973	0	0	1396	0	248.4	25.7	0.2	59.98	539	0	1	248.5	123.2	1546.6
11	2024-03-07 12:01:10	0x0C	345.4	4.3	5.3	53.1	66%	1925	0	0	1272	0	248.2	25.7	0.2	59.99	615	0	1	248.2	123.2	1546.6
12	2024-03-07 12:00:08	0x14	345.8	4.5	5.5	52.8	66%	1702	0	0	0	0	247.8	25.7	0.2	59.97	1669	0	1	248	123.2	1546.6
13	2024-03-07 11:59:09	0x14	345.9	4.7	5.6	52.9	66%	1766	0	0	0	1049	247.2	25.7	0.2	60.03	2761	0	1	247.8	123.2	1546.6
14	2024-03-07 11:58:08	0x14	346.5	4.7	5.6	52.9	66%	1867	0	0	0	953	247.8	25.7	0.2	59.99	2765	0	1	247.1	123.2	1546.6
15	2024-03-07 11:57:08	0x14	345.6	4.5	5.5	53	66%	1927	0	0	0	890	246.9	25.7	0.2	59.99	2762	0	1	247.1	123.2	1546.6
16	2024-03-07 11:56:06	0x0C	345.2	4.1	5.3	53.2	66%	2195	0	0	111	0	246.5	25.7	0.2	59.96	2042	0	1	246.4	123.2	1546.6
17	2024-03-07 11:55:06	0x0C	348	4.2	5	53.2	66%	2105	0	0	1456	0	247.2	25.7	0.2	59.98	608	0	1	248	123.2	1546.6
18	2024-03-07 11:54:06	0x0C	338.4	4.9	4.7	53.2	66%	1932	0	0	1314	0	247.6	25.7	0.2	60.01	580	0	1	247.6	123.2	1546.6
19	2024-03-07 11:53:06	0x0C	341.5	4.9	4.5	53.1	66%	1771	0	0	1139	0	248.1	25.7	0.2	59.97	597	0	1	247.3	123.2	1546.6
20	2024-03-07 11:52:06	0x0C	342	4.8	4.4	53.1	66%	1599	0	0	953	0	246.9	25.7	0.2	60	615	0	1	246.9	123.2	1546.6
21	2024-03-07 11:51:05																					

Name	Description
Vpv/Ppv	To check the MPPT
Vo/Po/So	To check the load type and if there is an overload when in load mode
Vb/SOC	To check the current state of charge and if the battery is overcharged or overly discharged.
Vac/Fac	To evaluate Grid performance and to check if working voltage and frequency range is adjusted to comply with grid
E-xxday	To evaluate energy distribution
E-xxall	To check if the system is working well under off grid mode

## Local Data

The data captured during the offline periods are displayed in the "Local data" section (loss of Internet or Wi-Fi). The only distinction from "Data History" is that it is used for offline data recording. Local data is recorded while the system is offline for more than 20 minutes and is taken every 5 minutes. Data can be stored in the system for a maximum of 90 days.

English

Monitor
Data
Configuration
Overview
Maintenance

Chart

Select station first
 

2024-04

[1, 90] Read Clear Export data

Serial number	Time	Status	Vpv1(V)	Vpv2(V)	vBat(V)	SOC(%)	Ppv1(W)	Ppv2(W)	pCharge(%)	pDisCharge	Vacr(V)	Fac(Hz)	Pinv(W)	Prec(W)	PF	Veps(V)	Feps(Hz)	Peps(W)	Septs(VA)	pToGrid	pToUser	ePv1(Da)

Energy

Data History

Local Data

Event History

## Event History

The "Event History" section displays a timeline of events. (Notice and Fault events) If there is not a record of a "historical event," the inverter is properly connected and working without any issues.

### 8.3.3 DASHBOARD (CONFIGURATION TAB)

The "Configuration" page is used for users to manage their station, dataloggers and user information.

Station	Serial number	Event Type	Event	Start Time	Time Recovered
1		Notice	W016: No AC Connection	2024-04-12 09:21:36	
2		Notice	W026: Battery voltage low	2024-04-12 08:28:52	2024-04-12 09:21:36
3		Notice	W027: Battery open	2024-04-12 08:20:04	2024-04-12 09:21:36
4		Notice	W016: No AC Connection	2024-04-11 11:01:26	2024-04-12 08:26:52
5		Notice	W000: Communication failure with battery	2024-04-09 10:33:05	2024-04-09 12:49:40
6		Notice	W026: Battery voltage low	2024-04-09 09:58:07	2024-04-11 11:01:26
7		Notice	W027: Battery open	2024-04-09 09:22:58	2024-04-11 11:01:26

## Stations

The Stations section will show all stations linked to the account. Clicking on a station name will display all inverters under that station or location.

Clicking the Add Station button creates another site if the user has more than one station under the same account. This is useful for distributors who have multiple customers that would like assistance with monitoring/troubleshooting their inverters.

Station name	Country	Timezone	Daylight saving time	Create date	Action
1 6000XP	United States of America	GMT -5	No	2023-07-24	Station Management

## Dongles

Users can add the datalogger Serial Number (SN) in the station if they have more than one inverter in the station. The inverter will be shown on the system immediately when powered on after adding the datalogger and configuring the proper password for the Wi-Fi datalogger. Dongles can also be searched by individual serial number.

Serial number	Dongle type	Station name	Firmware	Create date	Connect Status	Action
1 BA3	Wi-Fi	6K		2023-07-24	Lost	Management
2 BA3	Wi-Fi	6K		2023-07-24	Lost	Management
3 BA3	Wi-Fi	6K		2023-07-24	Lost	Management
4 BA3	Wi-Fi	6K		2023-07-24	Lost	Management
5 BA3	Wi-Fi	6K		2023-07-24	Lost	Management



**REMINDER:** Before configuring the password for the Wi-Fi datalogger, please add the datalogger to the monitor system.

## Devices

Users can see the entire inverter list connected to the account and check if the inverter is online. Data can be exported to an Excel file for record keeping or to view specific inverter stats.

## Users

This tab shows a full list of users, distributors and any other roles linked to the account. End users can edit password and personal information in the user page. Distributors can add an installer account and end user account on this page.

Serial number	Dongle	Station name	Device type	Battery type	Power Rating	Firmware	Status	Connect Status	BattParal	BattCapa	Export
1		Battery RD	18KPV	Lead-acid	12kW		Standby	Lost	0	600	false
2		Battery RD	18KPV	Lithium	12kW		Standby	Lost	1	280	true
3		Battery RD	18KPV	Lithium	12kW		Standby	Lost	6	596	true
4		Battery RD	12KPV	Lithium	5kW		Battery Grid on	Connected	8	1148	false

### 8.3.4 DASHBOARD (OVERVIEW TAB)

"Overview" allows EG4 or its distributors to quickly monitor system-wide data for their end users, such as solar yields, battery discharging, and other factors.

## Station Overview

All the stations linked to the account can be found here. Clicking a station name will switch the main page to show the real time data.

Name	Status	SolarPower	ChargePower	DischargePower	Load	Solar Yield	BatteryDischarging	FeedEnergy	ConsumptionEnergy
6K	Offline	0 W	0 W	0 W	0 W	62.3 kWh	275.2 kWh	0 kWh	85.2 kWh

## Device Overview

All the inverters linked to the account can be found here. Clicking a serial number will switch the main page to show the real time data for that inverter.

Serial number	Status	SolarPower	ChargePower	DischargePower	Load	Solar Yield	BatteryDischarging	FeedEnergy	ConsumptionEnergy	Station name	Parallel	Action
1	Offline	0 W	0 W	0 W	0 W	46.3 kWh	153.3 kWh	0 kWh	57.4 kWh	6K		
2	Offline	0 W	0 W	0 W	0 W	16 kWh	121.9 kWh	0 kWh	27.8 kWh	6K		

## 8.3.5 DASHBOARD (MAINTENANCE TAB)

The "Maintenance" view is used for firmware updates and to remotely change settings on the inverter by selecting a station and then an inverter serial number.

Distributors can manage all settings for all inverters at once with the help of the batch setting capability supported by EG4's monitor system.



**IMPORTANT:** Advanced technical knowledge is necessary to properly make changes. End users will only be able to see the "Remote Set" tab to make changes to their inverter.

## Remote Set



## 9. FIRMWARE UPDATES

### 9.1 FIRMWARE UPDATE VIA EG4 ELECTRONICS APP

When updating the firmware through the EG4 App, be sure to have plenty of battery life on the mobile device and do not close the application. Make sure the Wi-Fi dongle is connected securely and correctly configured for the inverter before performing the following steps.

**Step 1:** Open the EG4 Electronics App on the mobile device and select the “DOWNLOAD FIRMWARE” button.

**Step 2:** Choose the correct firmware file (contact the distributor for most up to date files) and select “DOWNLOAD” on the right side to download the file to the mobile device.

**Step 3:** Keep the app running and go to the phone’s Wi-Fi settings. Connect the mobile device to the Dongle’s network. The Dongle’s Network ID will be the same as the Dongle’s Serial Number.

**Step 4:** Return to the home screen of the app and select “LOCAL CONNECT”. Select the “Set” button on the bottom right side and proceed to the next step.

**Step 5:** After completing step 4, the Local Set Interface as shown above will appear. Swipe upward on the phone screen until the “Update Firmware” button is visible at the bottom of the app’s display.

**Step 6:** Choose the correct installation package in the dropdown box and click “UPDATE FIRMWARE” to begin the updating process.

After clicking the, “UPDATE FIRMWARE” button, the update will begin. Update progress can be viewed via the app as well as the inverter’s LCD screen. Once the update is completed, a notification will appear confirming that the firmware has been successfully updated (as shown in photo).

After successfully updating firmware, the inverter will restart itself.

**Make sure to update all inverters installed in the same ESS to the latest firmware.**

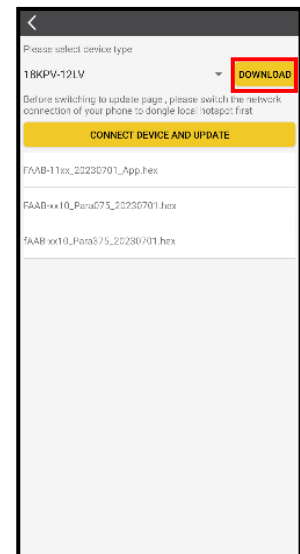
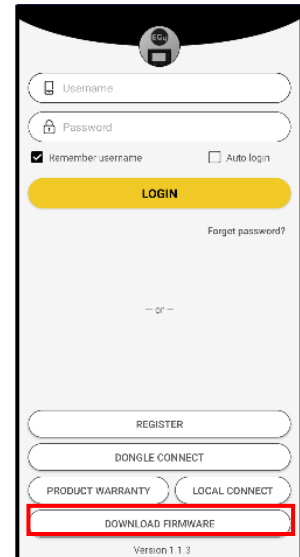

## 9.2 FIRMWARE UPDATE VIA MONITOR CENTER (WEBSITE)

**Step 1:** Distributors and installers can update the firmware for their inverters by using the EG4 Electronics website monitoring system. Please contact EG4 to ensure the latest version is applied.

The screenshot shows the EG4 Electronics Monitor System interface. The top navigation bar includes Monitor, Data, Configuration, Overview, and Maintenance (highlighted with a red box). Below the navigation bar, there are search filters for Station (Serial number) and Online Device (Auto Reload checked). A Firmware File section includes a file selection button and Upload File/Upload BMS File buttons. A table lists inverters with columns for Serial number, Dongle, FW Code, Connect Status, and Action. The 'Remote Update' button in the left sidebar is highlighted with a red box. The table shows the first inverter is 'Connected' and has 'Update' and 'Standard Update' buttons.

	Serial number	Dongle	FW Code	Connect Status	Action
1	1234567890	XX12345678	? XXXX-XXXX	Connected	Update Standard Update
2			?		Update Standard Update
3			?		Update Standard Update
4			?		Update Standard Update
5			?		Update Standard Update
6			?		Update Standard Update
7			?		Update Standard Update
8			?		Update Standard Update
9			?		Update Standard Update

**Step 2:** Log into the EG4 Electronics Monitor System. Select “Maintenance,” and then select “Remote Update.”

**Step 3:** Choose the inverter the user is attempting to update and then select “Standard Update”. The Monitor Center will begin updating both firmware files in the inverter. The latest version of the firmware will be displayed in the bottom right window.

This screenshot is similar to the previous one but shows the 'Standard Update' button for the first inverter highlighted with a red box. The 'Remote Update' button in the left sidebar is now highlighted with a yellow box. The search filters and other interface elements remain the same.

	Serial number	Dongle	FW Code	Connect Status	Action
1	1234567890	XX12345678	? XXXX-XXXX	Connected	Update Standard Update
2			?		Update Standard Update
3			?		Update Standard Update
4			?		Update Standard Update
5			?		Update Standard Update
6			?		Update Standard Update
7			?		Update Standard Update
8			?		Update Standard Update
9			?		Update Standard Update

## 10. SMARTPHONE APP SETUP

A monitoring account must be registered and the Wi-Fi password for the Wi-Fi dongle must be set **before** using EG4's monitoring system.

### 1. Register an account

Visit <https://monitor.eg4electronics.com/> or download the 'EG4 Monitor' App to register for an end-user account. Please contact support@eg4electronics.com for distributor or installer accounts.

### 2. When registering the account, provide the following information:

- Customer code: This is the code for a distributor or installer. Please contact the distributor or installer to obtain this code.
- Dongle SN: The serial number is attached to the Wi-Fi/LAN shell.
- Dongle PIN: PIN is attached to the Wi-Fi/LAN shell below the SN.

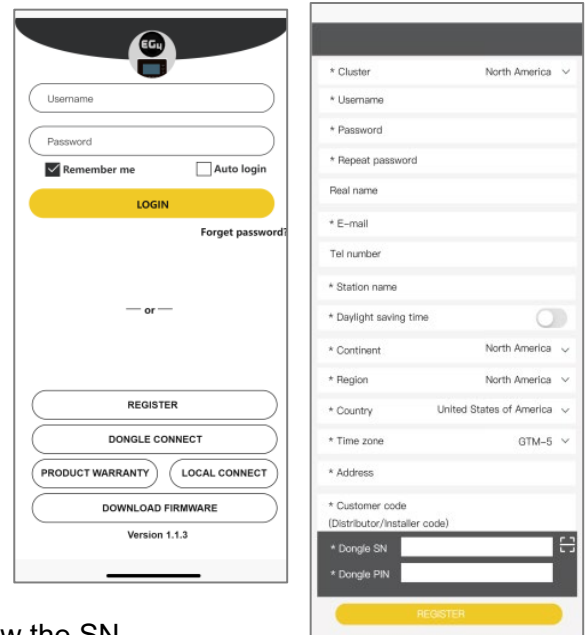

### 3. Set the Wi-fi password

- Plug in the Wi-Fi dongle, and power on the inverter.
- Wait until any LED on the Wi-Fi module is flashing, and then connect the phone to the Wi-Fi hotspot. The hotspot name is the same as the Wi-Fi dongle serial number. (See image on left)
- Open the app. Click on "Dongle Connect". Click the Yellow refresh button to display a list of available networks. Select the home wireless network name and enter the password.
- After clicking Home Wi-Fi Connect, the Wi-Fi dongle will reset. After setting the correct password, three lights will be solid ON, which means the inverter is connected to the server. Return to the login page and input the account and password to begin monitoring the system.

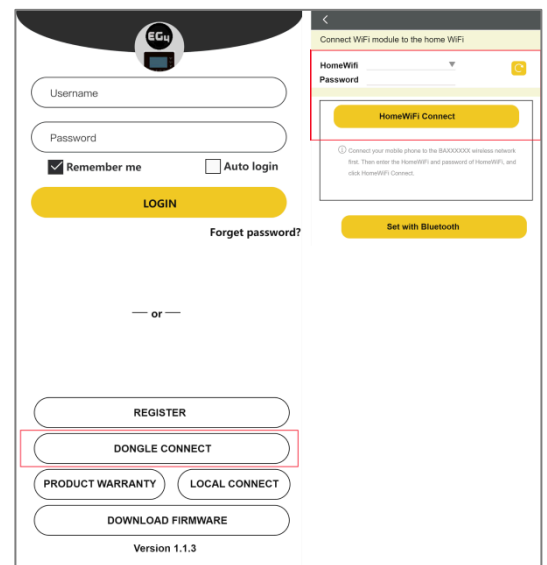
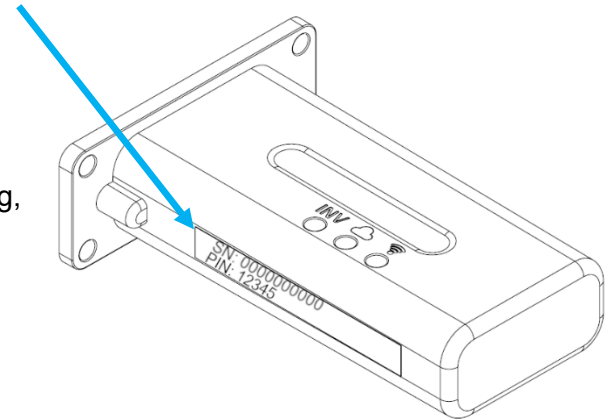
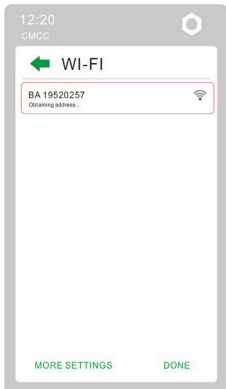

**IMPORTANT:** When following the steps above, if unable to link the dongle with the system using the Wi-Fi options, use the "Set with Bluetooth" (see image to the right) option located beneath the "Home WiFi Connect" selection to configure the dongle using Bluetooth. Remain near the device when configuring to ensure no data loss.

## Local Monitoring Setup with the EG4 Monitor App

If there is no Wi-Fi available at the location, the user can use the Bluetooth function on Bluetooth compatible mobile devices to monitor or set up the system.

1. Download the EG4 Monitor App.
2. Select "Local Connect." The user can now monitor and set up the system via Bluetooth or TCP Connect.
3. Click "Local Connect." Select "Bluetooth Connect." On the next page, select the serial number of the unit that has the dongle connected.

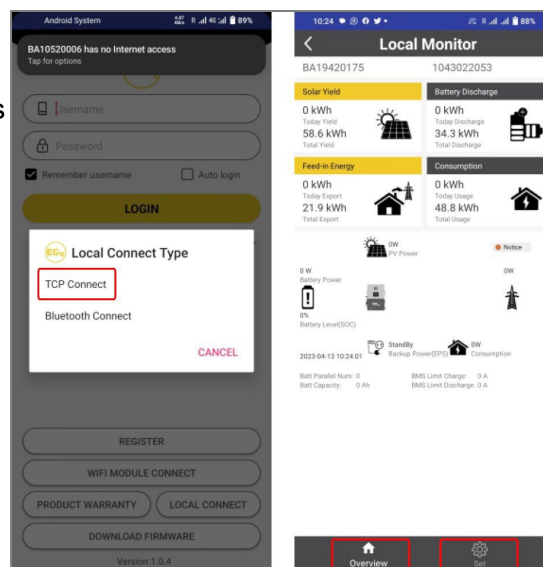

Now the user may view the system information through Bluetooth connection on the mobile device.



## 11. WORKING MODES

The table below describes how the inverter's LCD will display the different modes of operation per any given scenario.

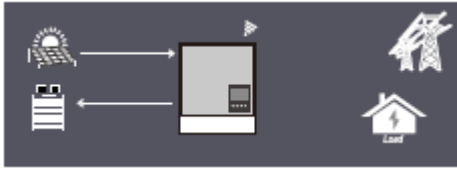
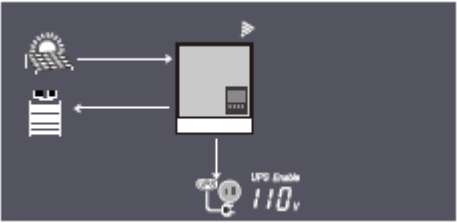
Mode	Diagram	Comments
Bypass Mode		AC powers the load
PV Charge Bypass		PV charges the battery while AC powers the load
BAT Off-Grid		Battery powers the load
PV+BAT Off-Grid		PV & Battery power the load

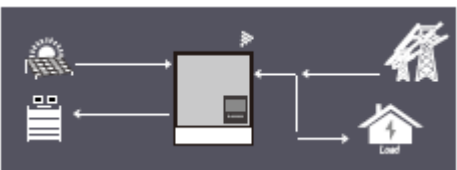
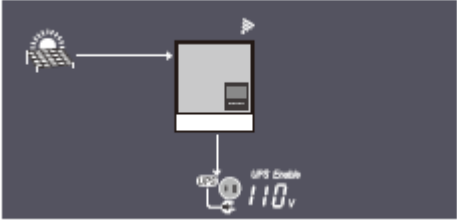
<p><b>PV Charge</b></p>		<ol style="list-style-type: none"> <li>1. With EPS output switch off, the inverter charges the battery only</li> <li>2. With battery power off, PV can wake up the battery automatically</li> </ol>
<p><b>PV Charge+Off-Grid</b></p>		<p>PV charges the battery and powers the load</p>
<p><b>AC Charge</b></p>		<ol style="list-style-type: none"> <li>1. AC powers the battery from AC Input (Grid) or Generator Input (GEN)</li> <li>2. When batteries reach low threshold, charge bank with Grid/GEN</li> </ol>
<p><b>PV+AC Charge</b></p>		<p>PV &amp; AC charge the battery. AC is from AC Input (Grid) or Generator Input (GEN)</p>
<p><b>PV Off-Grid</b></p>		<p>PV powers the load. NOTE: Load power depends on PV energy input and may be unstable</p>

## 11.1 RAPID SHUTDOWN (RSD)

The inverter includes a rapid shutdown system that complies with 2017 and 2020 NEC 690.12 requirements. A rapid shutdown switch should be connected to the RSD terminals on the master inverter and mounted in a readily accessible location outdoors (check with the local AHJ for specific requirements). For parallel systems, the RSD needs only to connect to the master inverter. When the switch is engaged, it will shut down all inverters in parallel past the master.



**NOTE:** When using supported EG4 batteries in closed-loop communications with the inverter, the RSD also initiates ESS Disconnect as required by NEC code

The system can utilize an External E-Stop Switch if the AHJ deems it necessary. When doing so, setting 28 must be set to Enable to engage the function.

### Type of External E-Stop Switch for RSD Requirements:

The external switch must be installed to normally open (NO) contact type for emergency shutdown.

## 11.1.1 EXTERNAL RSD WIRING INSTRUCTIONS

The image below showcases an example diagram using a Tigo RSD Transmitter (not included). Wire the E-Stop Switch into the RSD terminals on the master inverter, as shown below, following the specific switch's specifications. Please refer to the switch's manual for exact specifications and wiring instructions.

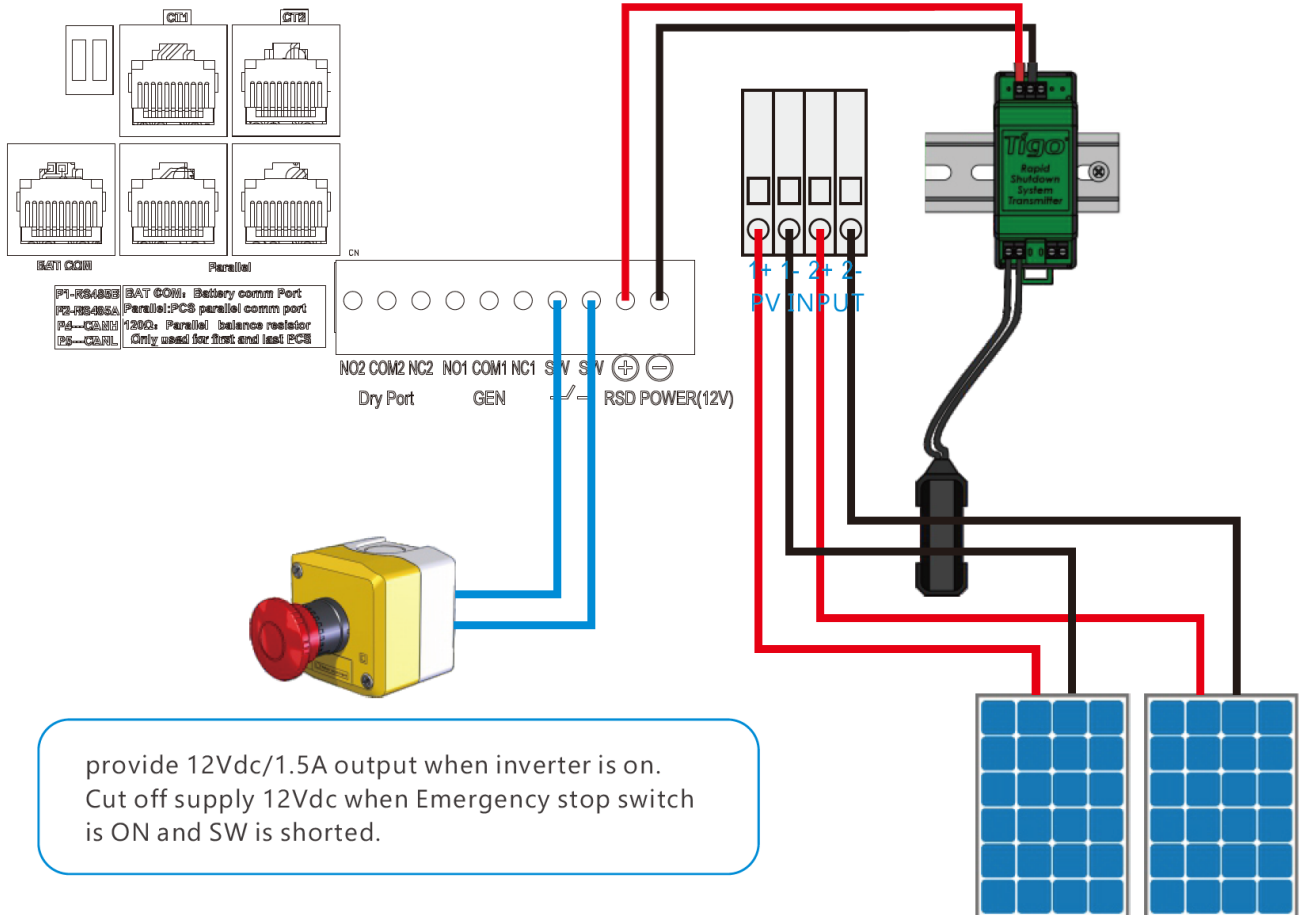

## 11.2 LCD DISPLAY AND SETTINGS

The user can wake up the LCD screen by simply pressing the Enter button. System status, real-time power, and daily and accumulated energy information can all be conveniently viewed on the inverter's LCD screen. Additionally, users can check the alarm and fault record on the display for troubleshooting.

LED Indicator		Info	
1 (Normal)	Green	Solid ON	Working normal
		Flashing	Fast: Warning Slow: Firmware Update
2 (Fault)	Red	Flashing	Fault detected in the inverter

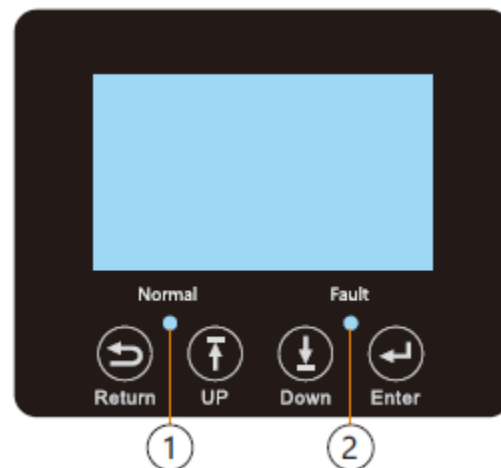

### 11.2.1 LCD DISPLAY

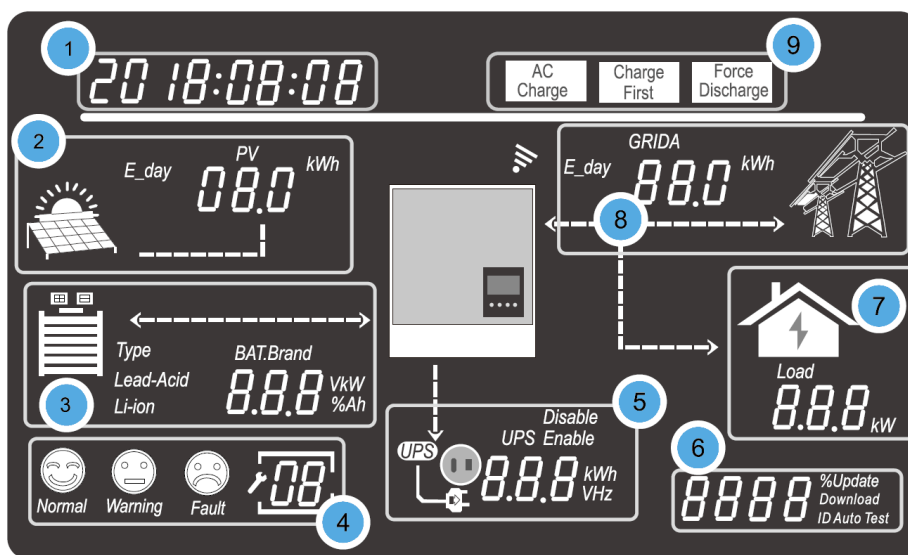

The data on the LCD screen updates every 3 seconds as various information is displayed in each section.

No.	Description	Comments
1	General Information Display Area	Displays the current system status by default. Pressing the Up/Down buttons will cycle through Time, Date, Single/Parallel Inverter Setting, Inverter Serial Number, and Firmware Version. When entering new settings, the selection information is displayed in this area.
2	Photovoltaic (PV) Data	Cycles every 3 seconds through: PV1 Voltage, PV2 Voltage, PV1 power, PV2 Power, PV1 Energy (day), PV2 Energy (day), PV1 Energy (total to-date), and PV2 Energy (total to-date).
3	Battery Information and Data	Displays the battery type and brand. For lead-acid batteries, this area will cycle every 3 seconds through the CV voltage, Float Charge Voltage, Cut-off Voltage, and Discharge End Voltage. For Lithium-ion batteries, this area will cycle every 3 seconds through the Voltage (V), SOC (%), Power (kW), and Capacity (Ah).

4	System Status and Codes	<p>There are three system status icons: Normal, Warning and Fault, and a 2-digit field that displays codes.</p> <ul style="list-style-type: none"> <li>Status = 'Normal': nothing is displayed in the 2-digit field</li> <li>Status = 'Warning': warning code is displayed in the 2-digit field. <ul style="list-style-type: none"> <li>Status = 'Fault': fault code is displayed in the 2-digit field.</li> </ul> </li> <li>System in 'Setting' mode: current Setting is displayed in the 2-digit field.</li> </ul>
5	UPS/EPS output information and data	When the UPS function is enabled, this area will cycle every 3 seconds through UPS1 V, UPS1 Hz, UPS1 kW, UPS2 V, and UPS2 kW. There is no UPS2 Hz, because it will always be the same as UPS1 frequency by default. UPS1=Phase1=L1, UPS2=Phase2=L2.
6	Programming & the percentage of AC output power	When in Off-Grid mode, this area will display the percentage of the maximum AC output power. Relevant information is displayed during firmware updates
7	Load consumption	Displays the power consumption by the load in the On-grid Mode.
8	Grid and Generator information	Cycles every 3 seconds through: Grid1 Voltage, Grid2 Voltage, Grid Hz, Gen1 Voltage, Gen2 Voltage, Gen Hz, Grid Power, Grid Energy (day), and Grid Energy (total to-date). Grid1=Phase1=L1, Grid2=Phase2=L2; Gen1=Phase1=L1, Gen2=Phase2=L2
9	Working mode area	When the user makes changes to the 6000XP inverter through the LCD, this area will display the AC Charge, Charge First and Force Discharge settings. Otherwise, this area displays nothing.

## Inverter Status Displays

### Normal/Running Status:

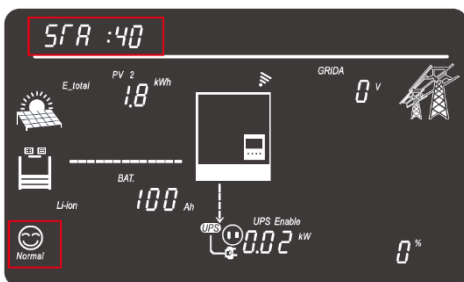

### Warning Status:

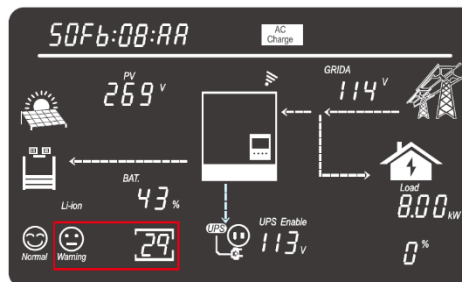

### Fault Status:

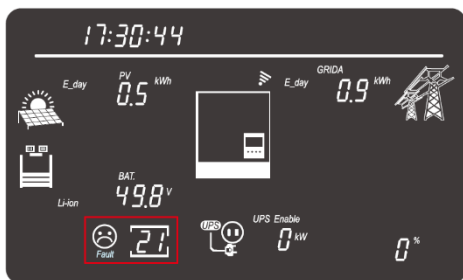

### Flash Status:

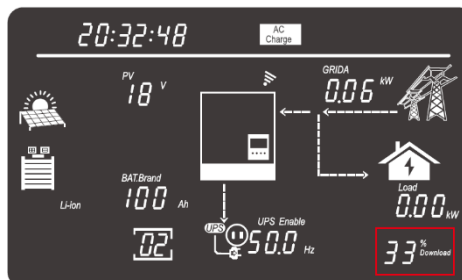



## Grid Status for GRIDA (Utility):

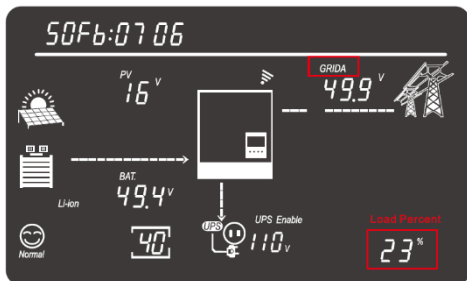

**NOTE:** When GRIDA is displayed, AC utility information is displayed. Percent at bottom right is load% (e.g., 23%).

## Grid Status for GRIDB (Generator):

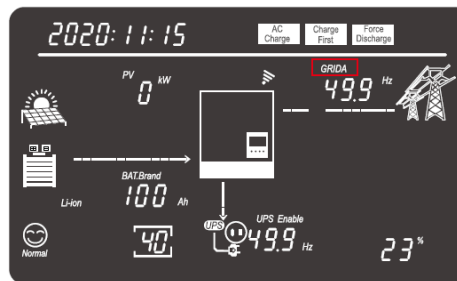

**NOTE:** When GRIDB is displayed, generator information is displayed. Percent at bottom right is load% (e.g., 23%).

## 12. LCD SETTINGS

There are four (4) buttons on the LCD screen used to select various modes and make changes to settings:



**Step 1:** Press the Enter button for ≈3 seconds to enter the **setting mode**. The data in the 'General Information Display Area' will flash and the 2-digit Setting field will be displayed.



**Step 2:** Press Up/Down to cycle through the settings (1-29).

**Step 3:** Press Enter to confirm the desired setting.

**Step 4:** Press Up/Down to cycle through the settings.

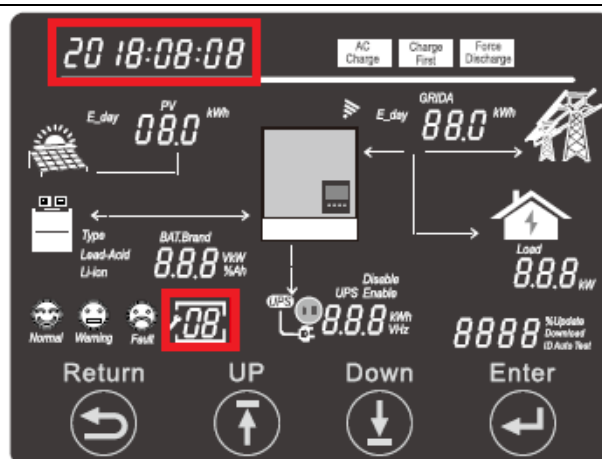
**Step 5:** Press Enter to confirm the desired setting.

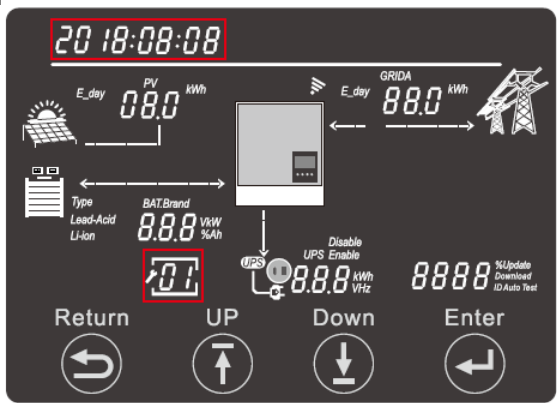
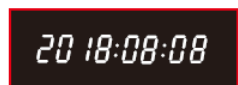



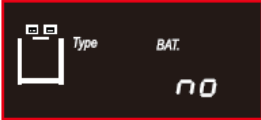
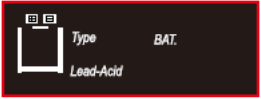
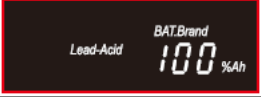
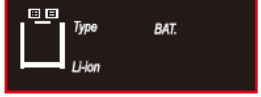
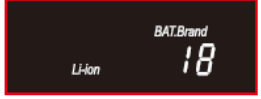

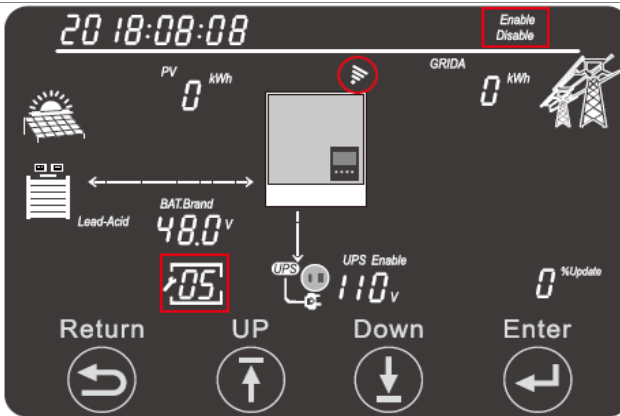
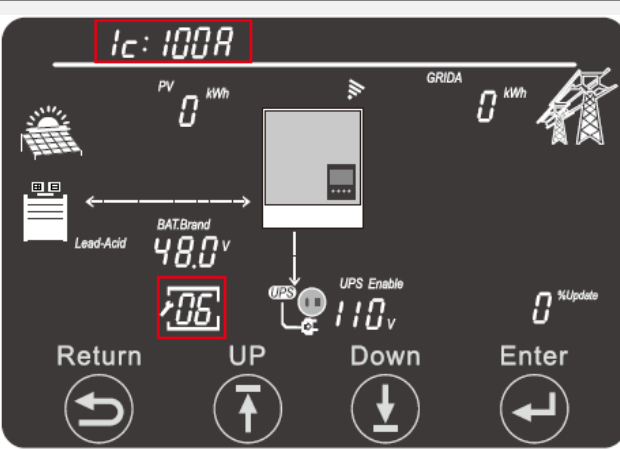
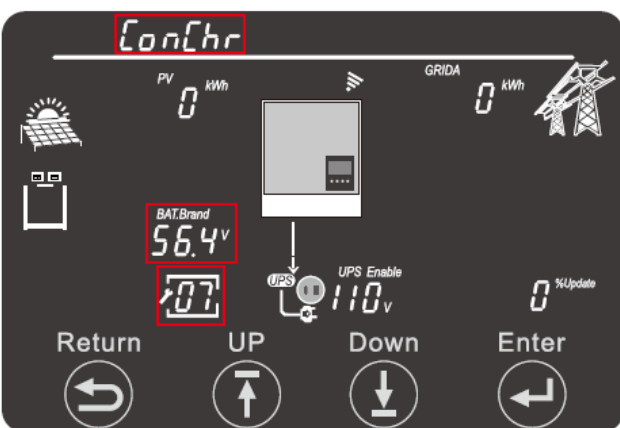
#	DESCRIPTION	SETTING OPTION(S)
1	Date & Time	 <p>Setting Year/Month/day</p>  <p>Setting hour/minute/second</p>  <p>This setting allows the user to set the Local Date and Time.</p>

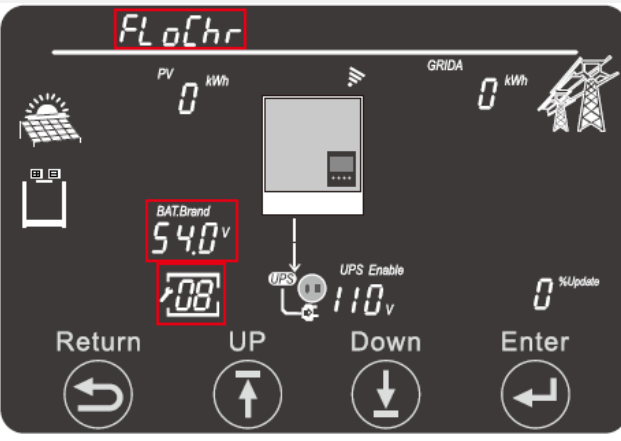
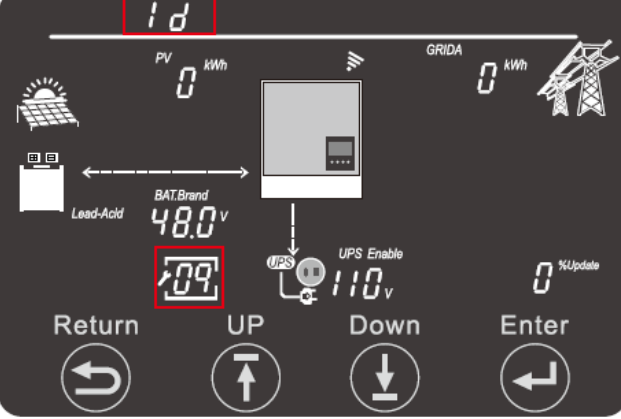
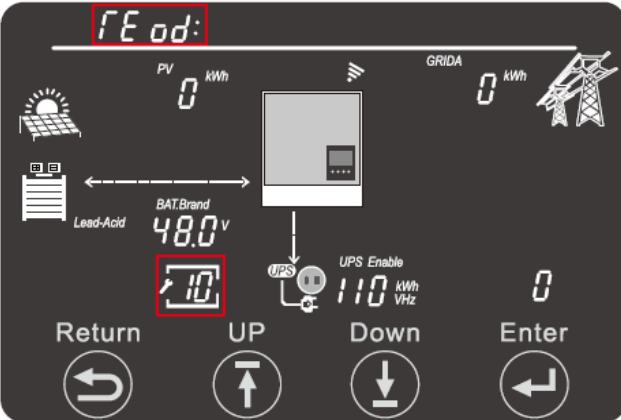
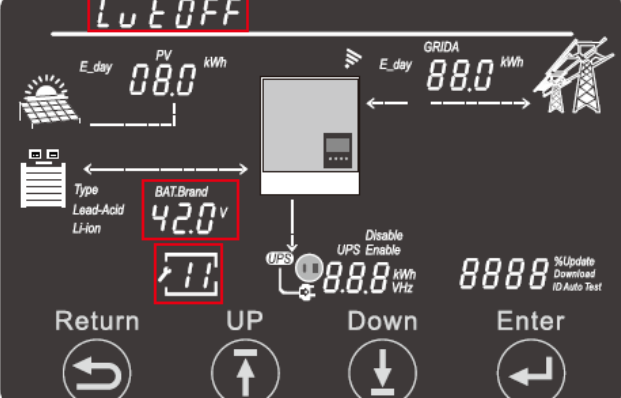
<p>2</p>	<p>PV Input Mode</p>		<p>This setting allows the user to set the PV Input Mode.</p> <p><b>PV Input Type:</b>  <b>S</b>=two independent strings,  <b>P</b>=same string input for 2 MPPTs          Default: S</p>
<p>3</p>	<p>Battery</p>	<p>This setting allows the user to identify if Batteries will be used in the system and, if yes, the type of batteries (Lead-Acid or Lithium).          Operate with <b>No Battery</b>  <b>Step 1:</b> Choose battery type first. When “no” begins flashing, select Enter to operate with No Battery</p> <p> <b>REMINDER: It is NOT recommended to operate without batteries</b></p> <p>Operate with Lead-Acid Battery  <b>Step 1:</b> Choose battery type first. When “Lead-Acid” begins flashing, select Enter to operate with Lead-Acid Batteries.  <b>Step 2:</b> Enter the Battery Capacity (Ah)</p> <p>Operate with Lithium Battery  <b>Step 1:</b> Choose battery type first. When “Li-ion” begins flashing, select Enter to operate with Lithium Batteries.  <b>Step 2:</b> Enter the Battery Brand (e.g., 0=EG4, 2=Pylon, 6=LuxPower, 8=Dyness)</p>	    
<p>4</p>	<p>UPS Output Voltage and Frequency</p>		<p>This setting allows the user to set the inverter output voltage and frequency.</p> <p><b>AC Output Voltage:</b>          200VAC, 208VAC, 220VAC, 230VAC, 240VAC          Default: 240VAC</p> <p><b>AC Output Frequency:</b>          50Hz, 60Hz          Default: 60Hz</p>



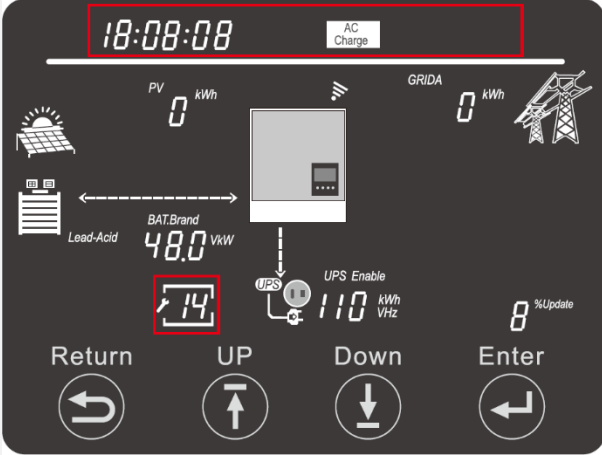

<p>5</p>	<p>Buzzer Enable</p>		<p>This setting allows the user to enable or disable the inverter buzzer.</p> <p><b>Inverter Buzzer:</b>          Enable/Disable          Default: Enable</p>
<p>6</p>	<p>Ic: Maximum Charge Current (Utility+Solar)</p>		<p>This setting allows the user to set the maximum charge current.</p> <p><b>Total Charge Current:</b>  <b>Range:</b> 0 – 125A          Default: 125A</p> <p><b>AC Charge Current:</b></p> <div style="border: 1px solid black; padding: 5px; width: fit-content; margin: 5px 0;">12c: 30A</div> <p><b>Range:</b> 0 – 125A          Default: 30A</p> <p><b>Generator Charge Current:</b></p> <div style="border: 1px solid black; padding: 5px; width: fit-content; margin: 5px 0;">19c: 30A</div> <p><b>Range:</b> 0 – 110A          Default: 30A</p>
<p>7</p>	<p>ConChr: CV Voltage (Lead-Acid Only)</p>		<p>This setting allows the user to set the Charging Voltage for Lead-Acid batteries only.</p> <p><b>Lead-Acid Charging Voltage:</b>  <b>Range:</b> 50.0 – 59.0VDC          Default: 56.4VDC</p>

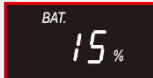
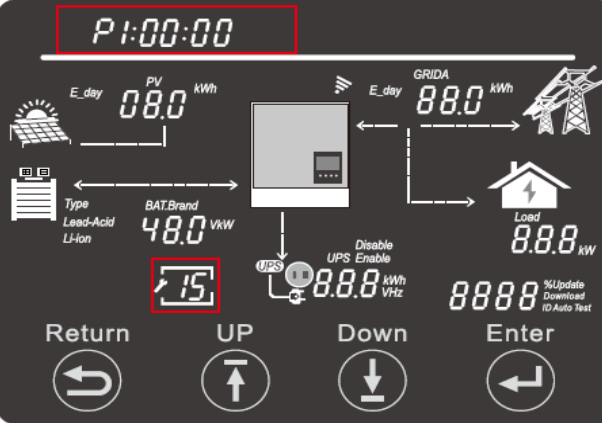
<p>8</p>	<p>FloChr: Floating Charge Voltage (Lead-Acid Only)</p>		<p>This setting allows the user to set the Lead-Acid Battery Float Charge Voltage.</p> <p><b>Lead-Acid Floating Charge Voltage:</b>  <b>Range:</b> 50.0 – 56.0VDC  <b>Default:</b> 54.0VDC</p>
<p>9</p>	<p>Id: Maximum Discharge Current</p>		<p>This setting allows the user to set the Maximum Discharge Current.</p> <p><b>Maximum Discharge Current:</b>  <b>Range:</b> 10 – 140A  <b>Default:</b> 140A</p>
<p>10</p>	<p>TEOd: Discharge Control Type (Volt/SOC)</p>		<p>This setting allows the user to select Voltage or SOC as the trigger for battery discharge.</p> <div style="border: 1px solid black; padding: 5px; margin: 5px;">TEOd:VdL</div> <div style="border: 1px solid black; padding: 5px; margin: 5px;">TEOd:SOc</div>
<p>11</p>	<p>CutOFF: Cut off Voltage/SOC</p>		<p>This setting allows the user to set the cutoff Voltage or SOC based on the selection made in Setting 10, TEOd.</p> <p><b>Cutoff Voltage:</b>  40.0 – On-Grid EOD Voltage  <b>Default:</b> 42V</p> <p><b>Cutoff SOC:</b>  <b>Range:</b> 0 – On-Grid EOD SOC%  <b>Default:</b> 15%</p>

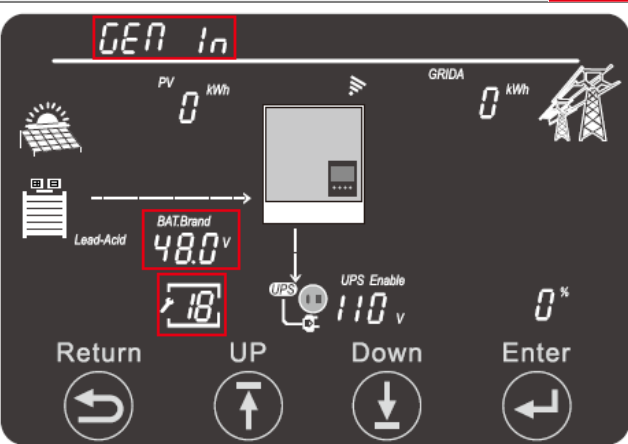
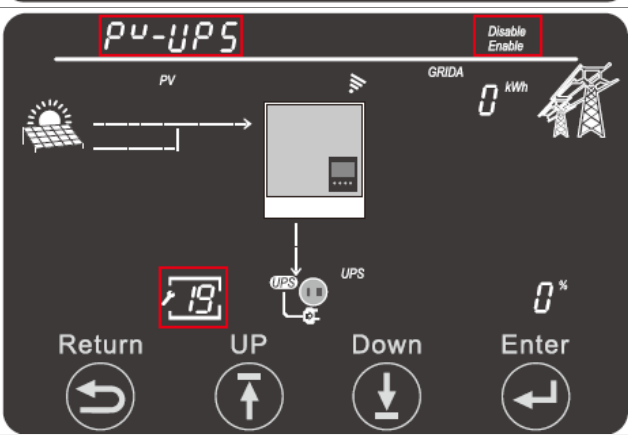
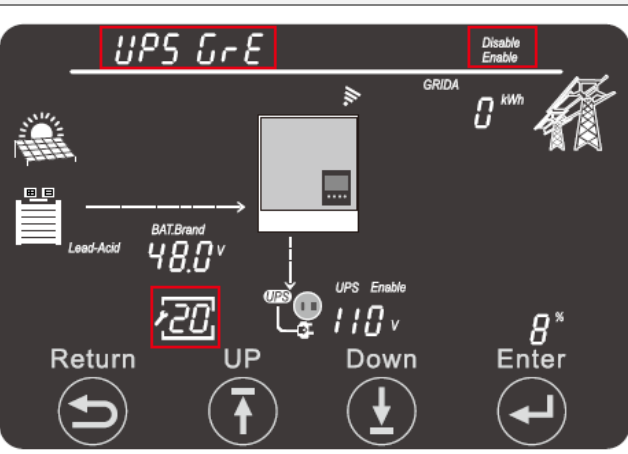

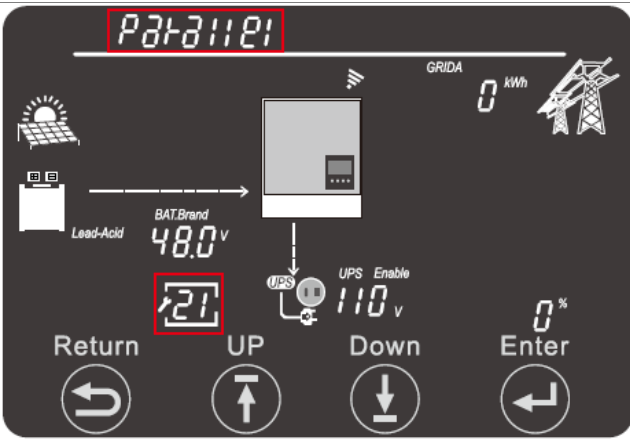

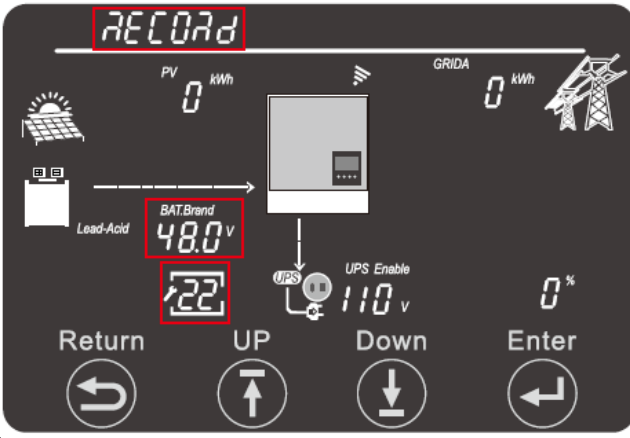

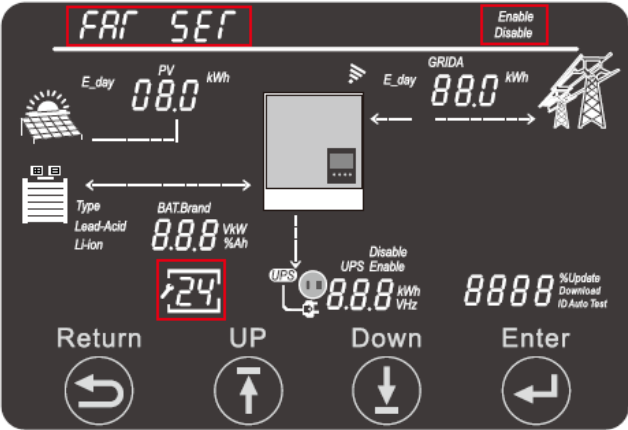

<p>12</p>	<p>Eod: Battery Discharge Cutoff</p>	<p>The top screenshot shows the 'Eod' menu with 'BAT.Brand' set to 42.0V. The bottom screenshot shows the 'Eod' menu with 'BAT.Brand' set to 15%.</p>	<p>This setting allows the user to set the End-Of-Discharge Voltage and SOC parameters.</p> <p><b>End of Discharge Cutoff Voltage:</b> Range: Cutoff Voltage – 58V Default: 42V</p> <p><b>End of Discharge Cutoff SOC:</b> Range: Cutoff SOC – 90% Default: 15%</p>
<p>13</p>	<p>AC In: AC Voltage Range Setting</p>	<p>The screenshot shows the 'Ac In' menu with 'BAT.Brand' set to 48.0V and 'UPS Enable' set to 13. Below the screenshot are two examples of the display showing 'Ac In: APL' and 'Ac In: UPS'.</p>	<p>This setting allows the user to set the AC Input Voltage Range</p> <p><b>AC In Voltage Range:</b> APL – 90-280VAC UPS – 170-280VAC</p>

<p>14</p>	<p>AC Charge Setting</p>	 <p>To configure AC charging, the user must first enable AC Charging, confirm the full battery SOC value, and set the confirmation time periods 1, 2, and 3.</p>   <p>AC Charge Control Settings for Voltage and SOC:  <b>Voltage:</b>          Start Voltage: 35.4 – 52V          End Voltage: 48 - 59V  <b>SOC:</b>          Start SOC: 1 – 90%          End SOC: 20 – 100%</p> <p>AC Charge Control Settings for Start/End Times:  <b>Start Time1-3:</b>  <b>Range:</b> 00:00 – 23:59          Default: 00:00 – 00:00  <b>End Time1-3:</b>  <b>Range:</b> 00:00 – 23:59          Default: 00:00 – 00:00</p>	 
<p>15</p>	<p>AC Input Load Timer Settings</p>		<p>This setting allows the user to set the Start/End times for the Grid/Utility to supply power to the load.</p> <p><b>Start Time1-3:</b> 00:00 – 23:59          Default: 00:00 – 00:00  <b>End Time1-3:</b> 00:00 – 23:59          Default: 00:00 – 00:00</p>

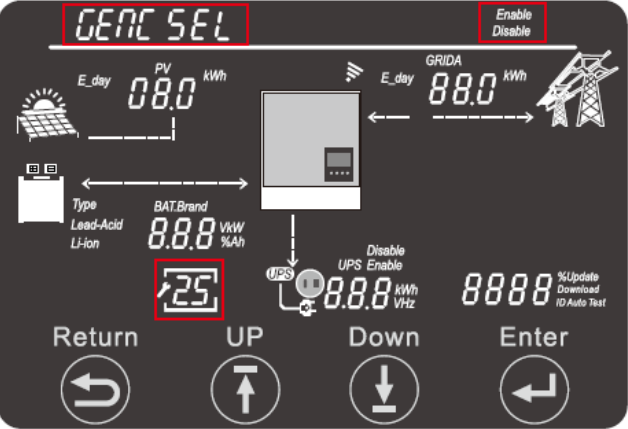
<p>17</p>	<p>Battery Wakeup</p>		<p>This setting allows the user to enable or disable the battery wakeup feature. It is not applicable if no battery type is defined. <b>Range:</b> Enable/Disable</p>
<p>18</p>	<p>Max Generator Input Power</p>		<p>This setting allows the user to set the maximum generator input power. <b>Range:</b> 0-7369W Default: 7369</p>
<p>19</p>	<p>PV Off-Grid Enable/Disable</p>		<p>This setting allows the user to configure the system to only use PV for loads. Due to voltage fluctuation, power output may be inconsistent. <b>Range:</b> Enable/Disable Default: Disable</p>
<p>20</p>	<p>Power Save Function</p>		<p>This setting allows the user to enable or disable the Power Save Functions, 'Green Function' and 'ECO Mode'. <b>Range:</b> Enable/Disable The default settings for both functions are set to disabled.</p>

<p>21</p> <p>Parallel Setting</p>	  <p><b>Parallel Type:</b> NoPL (Not Parallel), 1PH (Single Phase)          Default: NoPL  <b>Parallel Phase:</b> P1 (R-Phase), P2 (S-Phase)          Default: P1 (R-Phase)  <b>Battery Share Enable/Disable:</b> Disable/Enable          Default: Disable</p>	<p>This setting allows the user to select the inverter paralleling configuration.</p>
<p>22</p> <p>Error/Alarm Record</p>	  <p><b>Error Record:</b>-&gt;Record Setting-&gt;Record Message          (Year:Month:Day; Hour:Min:Sec; Error Code)  <b>Alarm Record:</b>-&gt;Record Setting-&gt;Record Message          (Year:Month:Day; Hour:Min:Sec; Alarm Code)</p>	<p>This setting allows the user to see Error and Alarm records.</p>

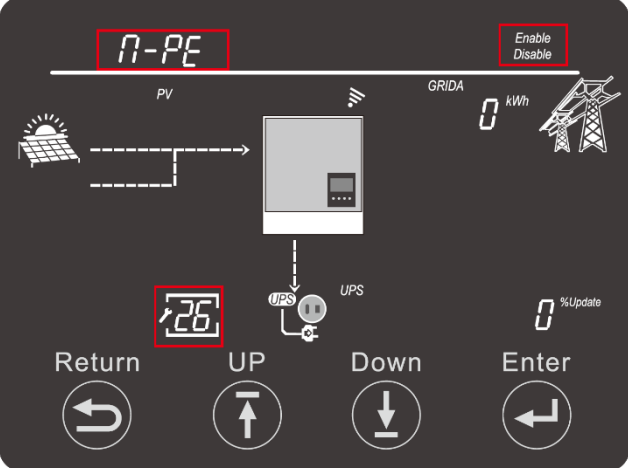

<p>24</p> <p>Fan Speed Setting</p>	 <p><b>Fan1/2 Slope: Enable/Disable</b> Default: Disable</p> <p><b>Range: 20 – 100%</b> Default: 70%</p>	<p>This setting allows the user to adjust the operation of the Inverter's two fans. The user can set the speed (20-100%) and enable or disable the slope (Enabling the slope allows the fans to ramp up/down to/from the fan speed setting).</p>  
<p>25</p> <p>Generator Charge Setting</p>	 <p><b>Generator Charge Control Type: VOL or SOC</b> Default: VOL</p> <p><b>Generator Charge Control Value (Volts):</b> Start Voltage: 38.4 – 52V, End Voltage: 48 – 59V</p> <p><b>Generator Charge Control Value (SOC):</b> <b>Range: Start SOC: 1 – 90%, End SOC: 20 – 100%</b></p>	<p>This setting allows the user to select the Generator charge control parameter (Voltage or SOC) and the associated Start/End Voltage or SOC.</p>    
<p>26</p> <p>Neutral-Ground Bonding Function</p>		<p>This setting allows the user to enable or disable the internal neutral-ground bond. The inverter must be in standby to make this change. Turn the “EPS Output” switch to off to engage standby mode.</p> <p><b>Range: Enable/Disable</b> Default: Enable</p>  

<p>27</p>	<p>PV Isolation Protection</p>	<p>The display shows 'PV-ISO' at the top left and '27' in the center. At the top right, there is a small 'Enable/Disable' indicator. Below the display are four navigation buttons: 'Return' (left arrow), 'UP' (up arrow), 'Down' (down arrow), and 'Enter' (right arrow). The background features a schematic of the inverter connected to PV panels and a grid.</p>	<p>This setting allows the user to enable or disable the PV Isolation Protection of the MPPT.</p> <p><b>Range:</b> Enable/Disable  <b>Default:</b> Disable</p> <p><b>Enable</b></p> <p><b>Disable</b></p>
<p>28</p>	<p>RSD Function</p>	<p>The display shows 'RSD' at the top left and '28' in the center. At the top right, there is a small 'Enable/Disable' indicator. Below the display are four navigation buttons: 'Return' (left arrow), 'UP' (up arrow), 'Down' (down arrow), and 'Enter' (right arrow). The background features a schematic of the inverter connected to PV panels and a grid.</p>	<p>This setting allows the user to enable or disable the RSD function of the inverter.</p> <p><b>Range:</b> Enable/Disable  <b>Default:</b> Enable</p> <p><b>Enable</b></p> <p><b>Disable</b></p>
<p>29</p>	<p>AFCI Protection</p>	<p>The display shows 'AFCI' at the top left and '29' in the center. At the top right, there is a small 'Enable/Disable' indicator. Below the display are four navigation buttons: 'Return' (left arrow), 'UP' (up arrow), 'Down' (down arrow), and 'Enter' (right arrow). The background features a schematic of the inverter connected to PV panels and a grid. Below the main display is a separate display showing 'AFCICLA' and another 'Enable/Disable' indicator.</p>	<p>This setting allows the user to enable or disable the Arc-Fault Circuit Interrupter protection of the inverter.</p> <p><b>Range:</b> Enable/Disable  <b>Default:</b> Enable</p> <p><b>Enable</b></p> <p><b>Disable</b></p>

## 13. INVERTER START-UP AND SHUT DOWN PROCEDURE

### 13.1 START-UP

Follow the steps outlined below to ensure proper start-up and shut down procedures to avoid potential component damage.

1. Ensure all circuit breakers are in the open (OFF) position.
2. Using a multimeter, check the battery bank to ensure no voltage (DC) is present.
3. Check the external PV Isolator Switch via multimeter to ensure the voltage (DC) is in the MPPT's optimal operating range.
4. If utilizing AC input, double check each hot line to neutral coming into inverter to ensure voltage is in operating range of the unit.
5. Upon confirming all voltages are within the inverter's operating range, close (ON) the battery breaker on the front of the unit. Close the external battery breaker between bank and inverter (if equipped).
6. Begin powering batteries on one at a time, starting with the master, in  $\approx 5$  second intervals.
7. Close the external PV isolator switch (if equipped). Close PV breaker on the side of the unit.
8. If using AC input, close external breaker between panel and inverter. Next, close the GRID breaker on the front of the unit.
9. Power on the inverter via the power switch on the side of the unit.
10. Close external AC Output breaker (if equipped) going to panel. Turn ON EPS Output (AC Output) switch on side of unit to begin powering loads.



**DANGER: Never disconnect battery, PV, or AC input power under loads. If there is an emergency and users must shut down the inverter, please follow the steps outline below.**

### 13.2 SHUT DOWN

1. Turn OFF EPS Output on side of inverter.
2. Open (OFF) GRID/GENERATOR breaker on front of unit.
3. Open LOAD breaker on front of unit. Open external AC output breaker (if equipped).
4. Open external PV isolator switch. Open PV breaker on side of the unit.
5. Open Battery Breaker on front of unit. Open external battery breaker (if equipped).
6. Power down batteries one at a time starting with the master.
7. Turn power switch on side of unit to OFF.

## 14. ERROR/WARNING TABLES

### 14.1 ERROR DEFINITIONS AND TROUBLESHOOTING

CODE	DESCRIPTION	TROUBLESHOOTING
E000	Internal Communication Fault	Restart inverter. If error persists, contact the distributor
E002	Bat On Mos Fail	Restart inverter. If error persists, contact the distributor
E003	CT Fail	Restart inverter, if the error persists, contact the distributor
E008	CAN communication error in parallel system	Ensure CAN paralleling cables are connected to proper ports between inverters
E009	No master in parallel system	Check parallel setting for Master/Slave to ensure there is only one Master set
E012	UPS output short circuit	Check if the load has a short circuit. If not, turn loads off and reset the system
E013	UPS reserve current	Restart the inverter. If error persists, contact the distributor
E016	Relay fault	Restart inverter. If error persists, contact the distributor
E017	Internal communication fault 2	Restart inverter. If error persists, contact the distributor
E018	Internal communication fault 3	Restart inverter. If error persists, contact the distributor
E019	Bus voltage too high	Check if PV input voltage is >480VDC
E020	EPS connection fault	Check if Inverter and AC connection is installed correctly
E021	PV voltage too high	Check if PV input voltage is >480VDC
E022	Over current internal	Restart inverter. If error persists, contact the distributor
E024	PV short	Check PV connections for short circuit
E025	Temperature too high	The internal temperature of the is too high. Turn the inverter off for 10+ minutes and restart the system. If error persists, please contact the distributor
E026	Internal Fault	Restart inverter. If error persists, contact the distributor
E028	Sync signal lost in parallel system	Ensure CAN paralleling cables are connected to proper ports between inverters
E029	Sync trigger signal lost in parallel system	Ensure CAN paralleling cables are connected to proper ports between inverters
E031	Internal communication fault 4	Restart inverter. If error persists, contact the distributor

## 14.2 WARNING DEFINITIONS AND TROUBLESHOOTING

CODE	DESCRIPTION	TROUBLESHOOTING
W000	Battery communication failure	Check the battery settings to ensure they are set for the specific battery type. Check the battery communications cable for proper pinning/installation.
W001	AFCI Com failure	Restart Inverter. If the error persists, contact the distributor
W002	AFCI High	Check each PV string for correct open circuit voltage and short circuit current. If the PV strings are in good condition, please clear the fault on inverter LCD
W003	Meter communication failure	Check communications cable. Contact the distributor if error persists
W004	Battery BMS fault	Inverter is receiving incorrect information from battery's BMS. Restart batteries and ensure the communication cables are installed correctly. If error persists, please contact the distributor
W006	RSD Active	Check if the RSD switch is pressed
W008	Firmware mismatch	Contact the distributor/installer for Firmware update
W009	Fan Stuck	Check if the fan is operable
W012	Bat on Mos	Restart the inverter. If error persists, please contact the distributor
W013	Over temperature	The temperature of inverter is nearing the high limit
W015	BatReverse	Double check battery connections to inverter. If error persists, contact the distributor
W018	AC Frequency out of range	Check AC frequency to ensure it is in the operable range
W019	AC inconsistent in parallel system	Ensure the AC input is from a common source and installed to each inverter in parallel. If error persists, contact the distributor
W020	PV Isolation low	Restart inverter. If the error still persists, contact the distributor
W025	Battery voltage high	Battery voltage is nearing the high limit
W026	Battery voltage low	Battery voltage is nearing the low limit
W027	Battery open	Check the battery for voltage via multimeter. Ensure all wires are correctly installed to inverter and battery
W028	Inverter overload	Inverter is running beyond max. output
W029	Inverter voltage high	Restart the inverter. If error persists, contact the distributor
W031	InverterVDC high	Restart the inverter. If error persists, contact the distributor

CODE	STATUS	DESCRIPTION
0×00	Standby	Inverter is in standby status
0×02	FW Updating	Inverter is updating firmware
0×08	PV Charge	Solar power exclusively charges the battery, with a maximum capacity limited by the battery's charging power. This mode commonly activates when the EPS switch is turned off.
0×10	Battery On-grid	With 'PV & AC Take Load Jointly' enabled, the inverter uses the battery to supply power to the load. If the battery capacity is insufficient to meet the load demand, the deficit is supplemented by drawing power from the grid.
0×11	Bypass	In off-grid mode, the inverter solely relies on grid power to supply the load. Solar power is dedicated exclusively to charging the battery, limited by the maximum charging capacity of the battery.
0×14	PV & Battery On-grid	1. When solar power is less than the load power, both solar and battery sources jointly supply the load. 2. The inverter operates in the AC First time period. 3. During the AC Charge time period, if the AC Charge requirement is not fulfilled, the inverter continues in the AC Charge mode.
0×19	PV Charge + Bypass	In off-grid mode with 'PV&AC Take Load Jointly' disabled, the load is exclusively supplied by grid power. Solar power is dedicated solely to charging the battery and is limited to the maximum charging capacity of the battery.
0×20	AC Charge	Grid power is supplying load and charging battery simultaneously.
0×28	PV & AC Charge	Battery is being charged by solar and grid power simultaneously while the load is supplied by grid power.
0×40	Battery Off-grid	Grid power is cut, and battery power is used to supply the load.
0×80	PV Off-grid	Grid power is cut, and the inverter supplies the load with available solar power.
0×C0	PV & Battery Off-grid	Grid power is cut, and the inverter supplies the load with a combination of solar and battery power.

## 15. INVERTER MAINTENANCE

Electrical equipment must be properly maintained to increase longevity and consistency. Follow the steps below to help prevent component damage/deterioration.

1. Inspect the inverter every month to confirm nothing covers the inverter heatsink. If there is cover, shut down the inverter and clear the heat sink to restore proper cooling.
2. Inspect the inverter every 3 months to verify the operating parameters are normal, and there is no abnormal heating or noise from any components in the system.
3. Inspect the inverter every 6 months to check for any damaged cables, accessories, or terminals.

If unable to identify the source of any potential abnormal operations, please contact the distributor's technical support team for additional information.



## CONTACT US

[support@eg4electronics.com](mailto:support@eg4electronics.com)

(903) 609-1988

[www.eg4electronics.com](http://www.eg4electronics.com)