



STEALTH

Designer⁺

UNIVERSAL FLOOR/CEILING INSTALLATION MANUAL

Models:

SC-09FM-HP230

SC-12FM-HP230

SC-18FM-HP230

SC-24FM-HP230



Thank you for choosing a Stealth Universal Floor/Ceiling Ductless Heat Pump System

Please read this installation manual carefully before installing and starting up the Floor/Ceiling Ductless System. Take a moment to fill out the product and installation form on the back cover. Retain both the manual and installation record for future reference.

Table of Contents

<i>Safety Precautions</i>	2
<i>System Requirements</i>	3
<i>Suggested Tools</i>	4
<i>System Parts</i>	5
<i>Installation Site Instructions</i>	6
<i>Indoor Unit Installation</i>	7-9
<i>Piping Installation</i>	10-13
<i>Power & Wiring</i>	14-16
<i>Controller Installation and Setup</i>	17
<i>Testing and Inspection</i>	18
<i>Troubleshooting</i>	19
<i>Diagnostic Codes</i>	20-23
<i>Installation Record</i>	Back

SAFETY PRECAUTIONS



Please read the following before installation.

	<p><i>This is the safety alert symbol. It is used to alert you to potential personal injury hazards. Obey all safety messages that follow this symbol to avoid possible injury or death.</i></p>
WARNING	<p><i>This mark indicates procedures which, if improperly performed, might lead to the death or serious injury of the user.</i></p>
CAUTION	<p><i>This mark indicates procedures which, if improperly performed, might possibly result in personal harm to the user, or damage to property.</i></p>
NOTICE	<p><i>Notice is used to address practices not related to personal injury.</i></p>

General Safety Precautions

- 1. Instructions for installation and use of this product are provided by the manufacturer. For proper operation, the system must be installed in accordance with this installation manual.*
- 2. Installation must be performed in accordance with local laws, regulations and National Electrical Codes (NEC).*
- 3. If there is a refrigerant leak while work is being carried out, ventilate the area. Do not allow refrigerant to come in contact with a flame as it produces toxic gas.*
- 4. Disconnect all electrical power to the indoor and outdoor units until the system is ready for start-up and checkout.*
- 5. When installing or repairing the system, use only R410A refrigerant. Do not mix refrigerant with other gases. If air or other gas enter the refrigeration system, the pressure inside the system may rise to an abnormally high value and cause damage or injury.*

WARNING

This appliance is not intended for use by persons (including children) with reduced physical, sensory or mental capabilities, or lack of experience and knowledge, unless they have been given supervision or instruction concerning use of the appliance by a person responsible for their safety.

SYSTEM REQUIREMENTS

PIPE SIZE in (mm)

Unit Size (BtuH)	Liquid Line	Suction/Gas Line	Net/Gross Weight
9,000	1/4 (6)	3/8 (9.5)	88/110 lbs.
12,000	1/4 (6)	3/8 (9.5)	88/110 lbs.
18,000	1/4 (6)	1/2 (12)	88/110 lbs.
24,000	3/8 (9.5)	5/8 (16)	100/120 lbs.

Interconnecting Cable

The Floor/Ceiling unit is powered from the outdoor unit. Use recommended 14/4 AWG stranded copper conductors THHN 600V unshielded wire.

NOTE: Use shield cable if installation is in close proximity of RF and EMI transmitting devices.

Condensate Drainage

It is recommended that condensate drainage systems use pipe either the same diameter or larger (excluding the raising section) than that of the connecting pipe. The unit condensate port is 0.67 in. (17mm) outside diameter.

NOTE: Insulate all condensate drain pipes to prevent sweating and possible water damage.



STEALTH

SUGGESTED TOOLS



- *Standard Wrench*
- *Adjustable/Crescent Wrench*
- *Torque Wrench*
- *Hex Keys or Allen Wrenches*
- *Drill & Drill Bits*
- *Hole Saw*
- *Pipe Cutter*
- *Screw drivers (Phillips & Flat blade)*
- *Manifold and Gauges*
- *Level*
- *R410A Flaring Tool*
- *Clamp on Amp Meter*
- *Vacuum Pump*
- *Safety Glasses*
- *Work Gloves*
- *Refrigerant Scale*
- *Micron Gauge*

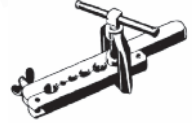

Indoor Unit

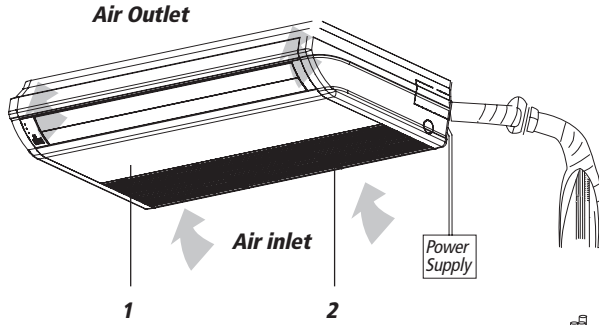

Part Name

1. Front Cabinet
2. Air Inlet
3. Wired Controller (Optional)
4. Remote Controller
5. Drain Pipe
6. Gas Pipe
7. Liquid Pipe
8. Service Cover
9. Front Panel

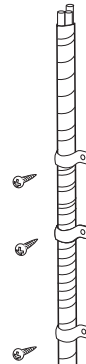
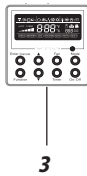

Outdoor Unit

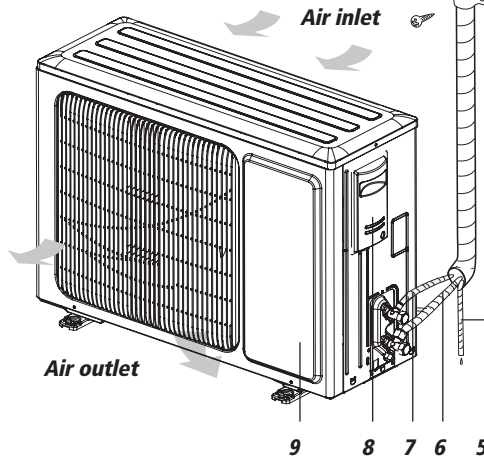

CAUTION

The refrigerant pipe, drain pipe and electrical wiring for this unit should be installed by a qualified HVAC professional only.

Indoor Unit

WARNING

The unit must be installed in a location which can withstand four times the weight of the unit. Inadequate support may result in serious property damage and injuries.

Select a site that allows for the following:

- Ensure the installation complies with the installation minimum dimensions and meets the minimum and maximum connecting piping length and maximum change in elevation.
- Air inlet and outlet should be clear of obstructions, ensuring proper airflow throughout the room.
- Condensate can be easily and safely drained.
- All connections can be easily made to outdoor unit.
- Indoor unit is out of reach of children.
- A structure strong enough to withstand four (4) times the full weight of the unit.
- Filter can be easily accessed for cleaning.
- Leave enough free space to allow access for routine maintenance.
- Do not install in a laundry room or by a swimming pool due to chemicals corroding indoor unit coil.

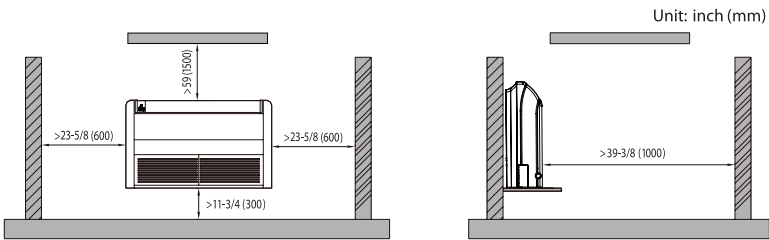

◆ Ceiling type

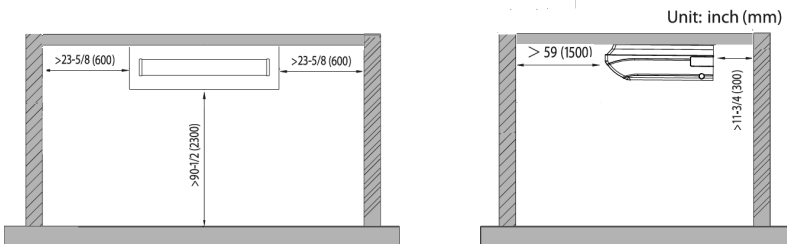

Indoor Unit Dimensions

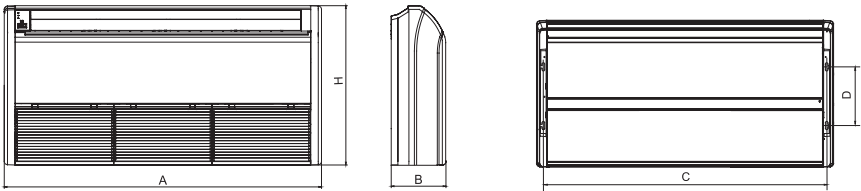

INDOOR UNIT DIMENSIONS Inches (mm)

Model	A	B	C	D	H
SC-09FM-HP230	48/1220	8.9/225	45.6/1158	11/280	27.6/700
SC-12FM-HP230	48/1220	8.9/225	45.6/1158	11/280	27.6/700
SC-18FM-HP230	48/1220	8.9/225	45.6/1158	11/280	27.6/700
SC-24FM-HP230	48/1220	8.9/225	45.6/1158	11/280	27.6/700

Preparing Indoor Unit for Installation

Begin the indoor unit installation by removing the air inlet grille and both side panels from unit as follows:

1. Remove the air inlet grille from the indoor unit to access screws that secure the side panels by unhooking grille latches and removing screws.

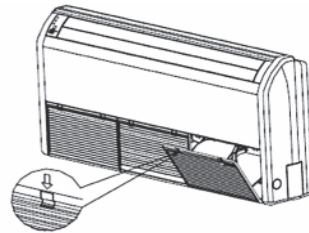
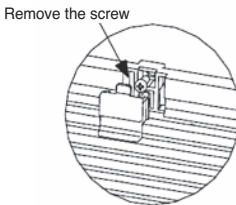

2. Locate and remove the screw securing right side panel. Remove right side panel from indoor unit by sliding it up and off as shown in the figure right.

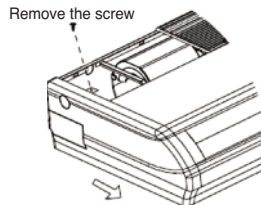

3. Repeat procedure to remove the left side panel

Laying Out Indoor Location

The Universal Floor/Ceiling units allow for wall or ceiling mounting. Follow the instructions for the desire type of installation.

Wall Mounting Installation

1. Determine the mounting location on the wall for the indoor unit. Follow the selection criteria in the previous section.
2. Locate the factory supplied installation template included in carton and attach to the wall.
3. Verify the installation template is level right to left and is a minimum 11 3/4 inches above the floor. Mark the 4 mounting holes for the indoor unit. Also mark the condensate drain and refrigeration pipe hole.

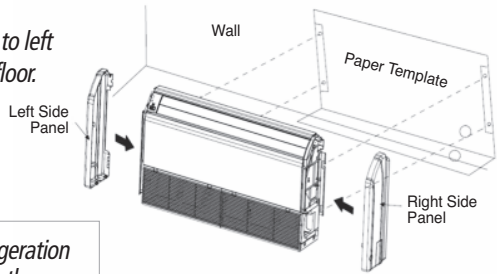
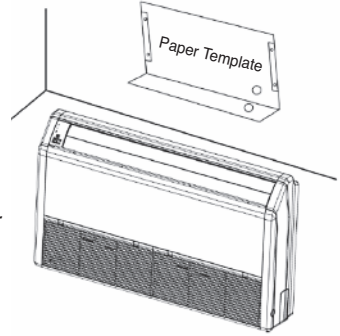

NOTE: Depending on the installation, the refrigeration pipes and condensate drain hose may exit from the rear or bottom of the unit.

4. Drill 4 mounting holes and insert anchor bolts (field supplied) into drilled holes.

NOTE: It is recommended to install screw anchors for sheet rock, concrete block, brick and such type of walls.

5. Verify indoor unit mounting by carefully lifting unit and setting it on the 4 anchor bolts using the factory provided slots on the side brackets as shown in figure right
6. Carefully remove indoor unit from anchor bolts in order to begin making piping connections.

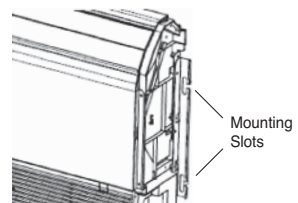

NOTE: Do not reinstall air inlet grille or side panels until instructed.

Ceiling Mounting Installation

1. Determine the mounting location on the ceiling for the indoor unit. Follow the selection criteria in the previous section.
2. Locate the factory supplied installation template included in carton and attach to the ceiling.
3. Mark and drill the 4 mounting holes for the indoor unit.
4. Depending on the type of ceiling, attach the threaded hanger bolts securely to the support stud. Before lifting the indoor unit to the installation location, insert the upper nuts, flat washers (with insulation), flat washers (without insulation), lower nuts and double locking nuts on the threaded hanger bolts.

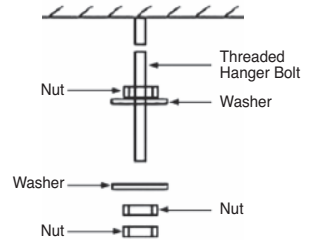
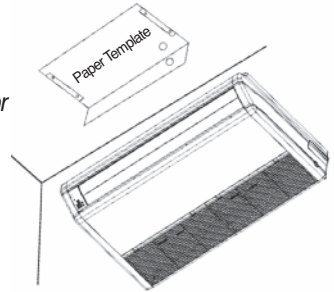

NOTE: The hanger bolts, nuts, and washers are field supplied. Install the washer with cushion so that the insulation faces downward.

5. Verify indoor unit mounting by carefully lifting unit and setting it on the 4 hanger bolts (between the two washers) using the factory provided slots on the side brackets as shown in figures right.
6. Confirm that the indoor unit main body is level horizontally as shown in figure bottom right. Adjust mounting nuts as needed.

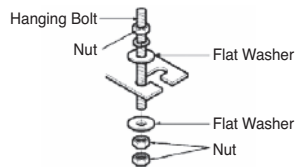
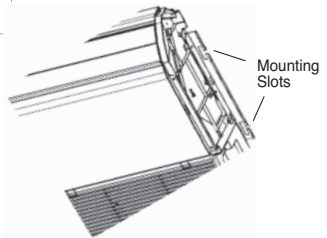

7. After checking the positioning of the indoor unit, securely tighten the hanger nuts to fasten the indoor unit in place.

NOTE: Do not reinstall air inlet grille or side panels until instructed.

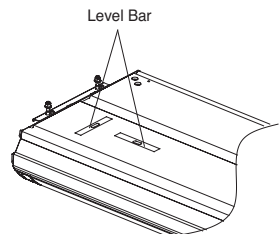

Refrigerant Piping

Drill Hole in Wall

1. Locate and mark proper location for the wall hole.
2. Cut the wall hole with a 5° to 10° downward slant to the outdoors. See Wall Hole Size table.
3. Insert a wall sleeve (field supplied) into hole to prevent damage to refrigerant pipes, insulation, condensate drain hose and wiring.
4. Proper weather proofing of the wall surface and wall sleeve is essential to assure a trouble-free installation. Apply sealant, caulking or equivalent weather proofing material around the perimeter of the wall sleeve (interior & exterior) to eliminate outdoor air and water leaks into the indoor space.

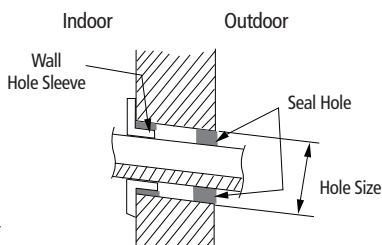

Wall Hole Diagram

Unit Size (BtuH)	Wall Hole Size Dia - inch (mm)
9,000	2 1/4 (55)
12,000	2 1/4 (55)
18,000	2 3/4 (70)
24,000	2 3/4 (70)

NOTE: Expandable foam insulation may be added to fill large wall gaps. Apply per manufacturer's instructions.

Piping Preparation

1. Do not open service valves or remove protective caps on pipes until instructed by this manual.
2. Keep tubing free of dirt, sand, moisture and contaminants.
3. Insulate each refrigerant pipe and condensate hose with minimum 3/8" (10 mm) wall thermal pipe insulation.
4. Bind refrigerant pipes and communication cable together with cable ties at 12-inch intervals.
5. Include the condensate hose in bundle for exterior portion only.

Indoor Unit below Outdoor Unit Application

When height difference between indoor unit and outdoor unit is more than 30 feet, an oil return bend should be added for every 20 feet of connection pipe as shown.

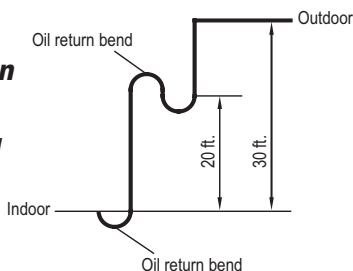

Indoor Unit Pipe Connections

1. Feed refrigerant pipes, drain hose and communication cable assembly through wall hole from outdoor to the Floor/Ceiling indoor unit.
2. Pull the piping assembly to the indoor unit. Carefully bend refrigerant pipes to meet indoor unit connection ports. Use proper tools to avoid kinks.
3. Add a small amount of refrigerant oil to both ends of the flare fittings.
4. Starting with either refrigerant pipe, carefully center the pipe to the indoor unit connection port then hand tighten the flare nut.
5. Repeat procedure with remaining pipe.
6. Tighten both flare nuts using a standard wrench and a torque wrench as shown below.

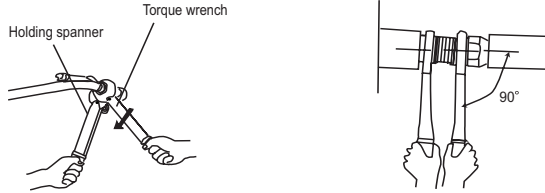
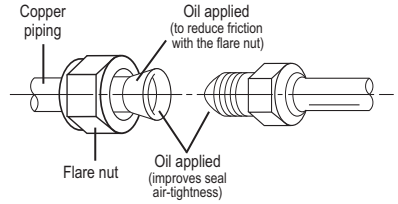

7. Carefully tighten flare nuts to correct torque level referring to the Torque Table below.

Pipe Diameter inch (mm)	Nut Size inch (mm)	Tightening Torque	
		ft-lbs	N-m
1/4 (6)	1/4 (17)	11 to 22	15 to 30
3/8 (9.5)	3/8 (22)	26 to 29	35 to 40
1/2 (12.7)	1/2 (25)	33 to 37	45 to 50
5/8 (16)	5/8 (29)	44 to 48	60 to 65

CAUTION

Over tightening may damage flare connections and cause leaks.

8. Individually insulate each bare refrigerant pipe and joint as shown below to prevent sweating.

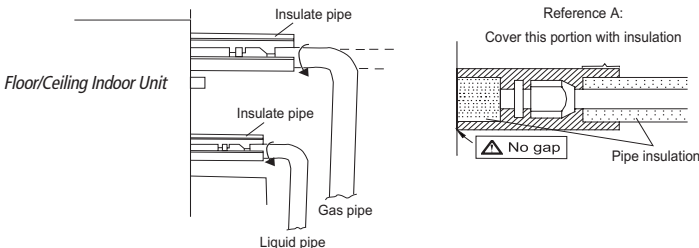

Outdoor Unit Pipe Connections

Carefully bend and adjust length of refrigerant pipes to meet outdoor unit port connections. See installation instructions shipped with the outdoor unit for further instructions.

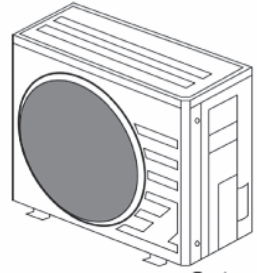

Indoor Condensate Drain Piping

WARNING

Observe all local sanitary codes when installing condensate drains.

The drain piping should be as short as possible with a constant downward slope. It is recommended to install the condensate drain system with hard polyvinyl chloride (PVC) pipe and matching connectors. Use piping of the same or greater diameter as the unit connection.

The Floor/Ceiling drainage port diameter is 11/16-in (17-mm) OD.

Pitch the condensate drain pipe at a gradual 2.5% pitch (Example: 1/4-in drop over a 10-in length) without obstructions. Use pipe hanger/brackets to support the condensate drain pipe from dropping.

Typical Drainage System

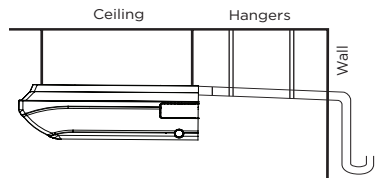

NOTE: Insulate condensate hose and/or pipes to prevent sweating which may cause water stains or wall damage.

If a gradual pitch from the drainage port is not obtainable, use an auxiliary condensate pump with float valve. A float valve is recommended to shut off the system if auxiliary pump fails.

Indoor Condensate Drain Piping (con't)

Completing Condensate Drainage Piping

- Include the exterior section of condensate hose in the pipe/wire bundle.
- Fasten the refrigerant and condensate pipe assembly to the exterior wall for support.
- The drain pipe should terminate 6 inches above grade.

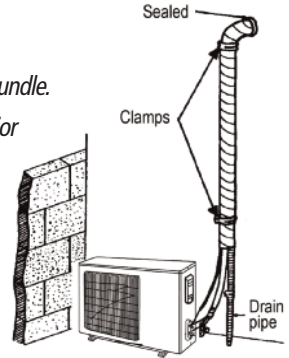

Test the Condensate Drainage Piping

- Find the drainage port with the air inlet grille and right side panel removed.
- Slowly add 20 to 24 oz. of water to the drain pan as shown below.
- Water must drain freely from the unit. If not, check the pipe slope or see if there are any pipe restrictions.
- Verify all piping joints are leak free.

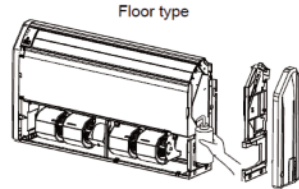
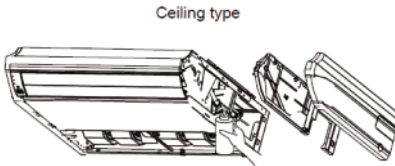

WARNING

- 1. Before obtaining access to wire terminals, all electrical supply circuits must be disconnected, locked out and tagged.*
- 2. Always use an independent (dedicated) circuit and provide an independent (dedicated) circuit breaker to supply power to the system.*
- 3. Use a circuit breaker with adequate capacity to meet the requirements of the total system.*
- 4. All circuit breakers or fuses for the indoor and outdoor units should be installed per the National Electric Code (NEC) and local regulations.*
- 5. Electrical wiring must be completed in accordance with NEC, local laws, and regulations of the electric company so that the system will operate properly.*
- 6. Provide a GFI circuit breaker at the electrical panel in accordance with the NEC and the local electrical company standards.*
- 7. Connect the power supply firmly to the terminal block. Improper installation may cause a fire.*

CAUTION

- 1. The main power supplies are high-voltage, while the communication wire and the Tether Controller are low-voltage. They should be installed separately to avoid electromagnetic interference.*
- 2. High-voltage and low-voltage lines should pass through separate rubber rings at electric box covers.*
- 3. If the indoor unit communication wire (to the outdoor unit) and power wire are connected incorrectly, the air conditioner may be damaged.*
- 4. Ground both indoor unit and outdoor unit to earth ground in accordance with the applicable local and national codes.*

Electric Wiring Between Indoor Unit and Outdoor Unit

Typical Wiring Diagram

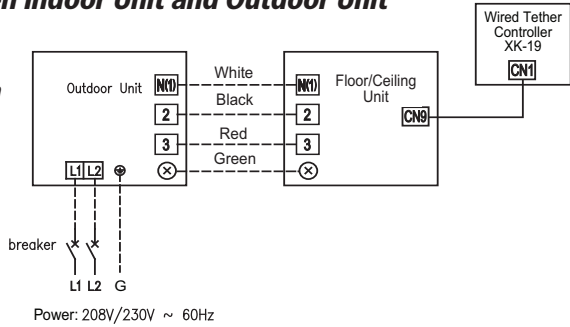

Outdoor Electrical Wiring

For Outdoor Unit wire connections, see installation instructions shipped with the outdoor unit.

Electrical Connections to Floor Ceiling

WARNING

Disconnect all electrical power to indoor and outdoor units including disconnects, fuses and circuit breakers. Lockout and tag all disconnect switches.

1. Adjust the length of the interconnecting wires so that it can easily reach the Floor Ceiling electrical control box.
2. Open electrical control box cover and route the interconnecting wires to field wiring terminal block.

NOTE: The indoor unit is powered from the outdoor unit, depending on local code, a disconnect switch may need to be installed to a power supply circuit.

3. Secure interconnecting wires to the terminal block as shown in the connection diagram at right:

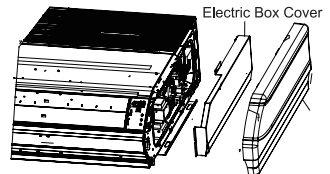

NOTE: Record wire colors and terminal references for uses with Outdoor Unit wire connections.

4. Secure all wires inside wire clamp/strain relief. Verify wires are secure, not loose and no external force on wires affects the connections at the terminals.

NOTE: Crossing interconnecting wires will cause system malfunction and possible damage.

5. Replace field wiring cover on unit.

Indoor Disconnect Switch (Optional)

Local codes may require a disconnect switch within sight of the indoor unit. Use a DFS Disconnect Switch Accessory Kit (Part No: DFS-SWITCH-A) to break interconnecting wires going to the N(1), 2, 3, terminals on the indoor unit, as shown in the wiring diagram below:

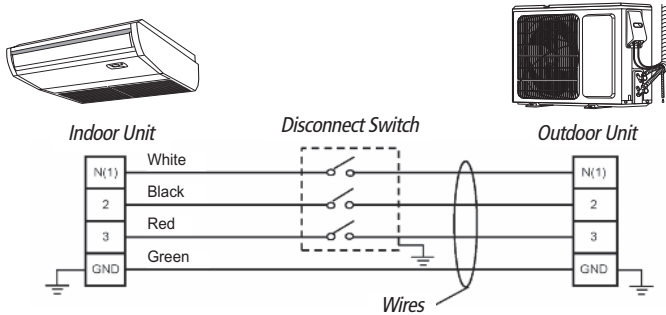

Installing Wired Tether Controller to Floor/Ceiling Unit

1. Open decorative grille and locate 4 pin connector for wired controller on Floor/Ceiling main body.
2. Route wired controller wires to 4-pin connector and connect Tether Controller to Floor/Ceiling.

NOTE: Use the supplied cable, with OEM plugs on either end. Do not cut or splice. Conceal any excess cable.

1. Replace decorative grille being careful not to pinch wires.
2. Remove back plate from Wired Controller.

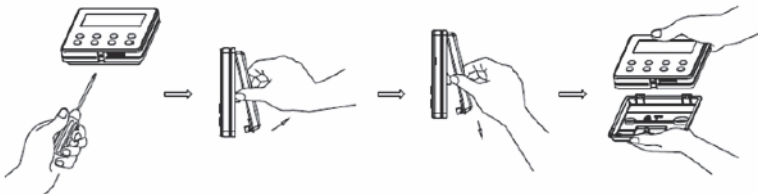

CONTROLLER INSTALLATION AND SETUP (Optional)

The following is a brief overview of the Wired Tether Controller installation. See Tether Controller Owner's Manual for more detailed instructions for setup and operation.

Preparation for Installation

Select a proper location on the wall for mounting the Tether Controller. Install switch box, if required by code. The maximum wire length between indoor and Tether Controller is 26 ft (8m). Run communication cable (as desired) between indoor unit and selected wall mounting location. See Indoor Unit wiring section for instruction to connect the Wired Tether Controller to the indoor unit.

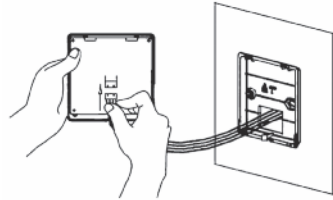
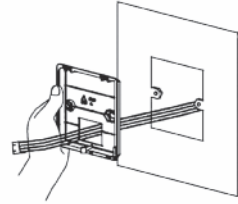

Wired Tether Controller Installation

Pull communication cable through switch box (if one is used) and Wired Tether Controller backplate. Securely fasten backplate to the switch box or wall.

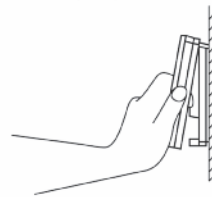

Locate wire terminals connector on rear of Tether Controller panel. Carefully connect wire to controller connector. Verify connector is secure, not loose and no external force on wires affects the connections at the terminals. Push extra cable into wall and secure controller panel to backplate mounted on the wall.

NOTE: Do not cut or splice communication cable.

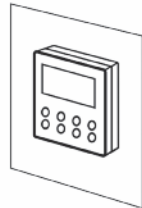

Overview of Display Panel

1. **Power Indicator:** Power indicator will be on after electrical power is turned on, while it will be off after disconnecting power.
2. **COOL Indicator:** COOL indicator will be on after COOL mode is activated while it will be off after COOL mode is turned off.
3. **Heat Indicator:** HEAT indicator will be on after HEAT mode is activated, while it will be off after HEAT mode is turned off.
4. **Indoor setpoint and temperature display.**

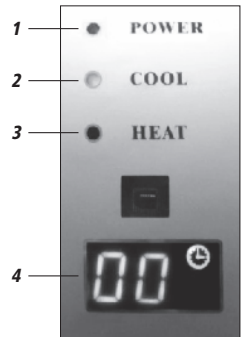

Start-up Checklist

Turn on main power to indoor and outdoor units.

- Verify the system is not displaying an error code on the indoor unit display.

Point the Remote Controller at the Floor/Ceiling unit and Press the On button.

- Verify the remote controller display turns ON and the Power Indicator lights up on the Floor/Ceiling unit.

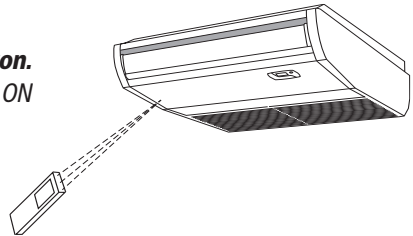

Press the Mode button to Cooling.

Adjust the room setpoint to bring the system on in cooling mode. The system should start cooling mode within 3-5 minutes.

- Verify the setpoint lights up on the Floor/Ceiling unit display.
- Verify the outdoor fan and compressor are operating.
- Verify the indoor fan is operating.
- Verify the indoor discharge air is cooling the room.

Press the Mode button to Heating.

Adjust the room setpoint to bring the system on in heating mode. The system should start heating mode within 3-5 minutes.

- Verify the new setpoint lights up on the Floor/Ceiling unit display.
- Verify the outdoor fan and compressor are operating.
- Verify the indoor fan is operating.
- Verify the indoor discharge air is heating the room.

Press the OFF button on the Remote Controller.

- Verify Remote Controller display turns OFF and the system shuts OFF.

PROBLEM	CAUSE/SOLUTION
System does not restart.	<p>Cause: The system has a built-in three-minute delay to prevent short and/or rapid cycling of the compressor.</p> <p>Solution: Wait three minutes for the protection delay to expire.</p>
Indoor unit emits unpleasant odor when started	<p>Cause: Typically unpleasant odors are the result of mold or mildew forming on the coil surfaces or the air filter.</p> <p>Solution: Wash indoor air filter in warm water with mild cleaner. If odors persist, contact a qualified service professional to clean the coil surfaces.</p>
You hear a "water flowing" sound.	<p>Cause: It is normal for the system to make "water flowing" or "gurgling" sounds from refrigerant pressures equalizing when the compressor starts and stops</p> <p>Solution: The noises should discontinue as the refrigerant system equalizes after two or three minutes.</p>
A thin fog or vapor coming out of the discharge register when system is running.	<p>Cause: It is normal for the system to emit a slight fog or water vapor when cooling extremely humid warm air.</p> <p>Solution: The fog or water vapor will disappear as the system cools and dehumidifies the room space.</p>
You hear a slight cracking sound when the system stops or starts.	<p>Cause: It is normal for the system to make "slight cracking" sounds from parts expanding and contracting during system starts and stops.</p> <p>Solution: The noises will discontinue as temperature equalizes after two or three minutes.</p>
The system will not run.	<p>Cause: There are a number of situations that will prevent the system from running.</p> <p>Solution: Check for the following:</p> <ul style="list-style-type: none"> • Circuit breaker is "tripped" or "turned off." • Power button of controller is not turned on. • Controller is in sleep mode or timer mode. • Otherwise, contact a qualified service professional for assistance.
The unit is not heating or cooling adequately.	<p>Cause: There are a number of reasons for inadequate cooling or heating.</p> <p>Solution: Check the following:</p> <ul style="list-style-type: none"> • Remove obstructions blocking airflow into the room. • Clean dirty or blocked air filter that is restricting airflow into the system. • Seal around door or windows to prevent air infiltration into the room. • Relocate or remove heat sources from the room.
Water leaking from the indoor unit into the room.	<p>Cause: While it is normal for the system to generate condensate water in cooling mode, it is designed to drain this water via a condensate drain system to a safe location.</p> <p>Solution: If water is leaking into the room, it may indicate one of the following.</p> <ul style="list-style-type: none"> • The indoor unit is not level right to left. Level indoor unit. • The condensate drain pipe is restricted or plugged. All restrictions must be removed to allow continuous drainage by gravity. • If problem persists, contact a qualified service professional for assistance.
The unit will not deliver air.	<p>Cause: There are a number of system functions that will prevent air flow.</p> <p>Solution: Check for the following:</p> <ul style="list-style-type: none"> • In heating mode, the indoor fan may not start for three minutes if the room temperature is very low. This is to prevent blowing cold air. • In heat mode, if the outdoor temperature is low and humidity is high, the system may need to defrost for up to 10 minutes before beginning a heating cycle. • In dry mode, the indoor fan may stop for up to three minutes during the compressor off delay. • Otherwise, you should contact a qualified service professional for assistance.

Troubleshooting

The unit has onboard diagnostics. The outdoor unit will provide status indicators. The indoor wall unit and remote controller will display error codes. The following is a summary of the codes with explanation:

Malfunction Name	Indoor Unit & Remote Display	Outdoor Unit Indicators		Possible Causes
		Yellow	Red	
X-fan Mode	AL			Operation status
Indoor Evap Coil Temperature Sensor Malfunction	b5			1) Loose or bad connection between sensor and control board 2) Indoor Evap Coil temperature sensor damaged 3) Control board malfunction
Gas valve temperature sensor is open/short circuited	b7			Hardware malfunction
System Configuration Malfunction	C5			1) No jumper cap inserted on the control board 2) Incorrect or damaged jumper cap on control board 3) Indoor and outdoor units are not compatible
Communication wire error or electronic expansion valve malfunction	dd			Operation status
Wrong connection of communication wire or malfunction of electronic expansion valve	dn			Hardware malfunction
System High Pressure	E1			1) Over charged with refrigerant 2) Blocked or dirty outdoor coil 3) Extreme outdoor ambient conditions
Indoor Anti-Freeze Protection	E2	3 flashes and 1 sec Off		1) Low return airflow 2) Indoor fan speed is too low 3) Indoor coil is blocked or dirty
Low Pressure Protection	E3		9 flashes and 1 sec Off	1) Low on refrigerant 2) Pressure sensor is damaged
Compressor High Discharge Temperature Protection	E4	7 flashes and 1 sec Off		Please refer to the malfunction analysis (discharge temperature, overload) in service manual
Overcurrent Protection	E5	5 flashes and 1 sec Off		1) Supply voltage is unstable 2) Supply voltage is too low and system load is too high 3) Indoor coil is blocked or dirty
Communication Malfunction	E6	Continuous On		1) Communication cable is mis-wired between indoor and outdoor units 2) Indoor or Outdoor control board malfunction
Mode conflict (Indoor units calling for simultaneously Heating and Cooling)	E7			Operation status

DIAGNOSTIC CODES



Malfunction Name	Indoor Unit Display	Outdoor Unit Indicators		Possible Causes
		Yellow	Red	
High Temperature Resistant Protection	E8	6 flashes and 1 sec Off		1) Incorrect refrigerant charge level 2) Refrigerant metering device malfunction 3) Compressor malfunction
Cold Air Protection	E9			1) Indoor coil has not reach minimum heating temperature 2) Indoor ambient is abnormally cold 3) Indoor control board malfunction
EEPROM Memory Malfunction	EE	11 flashes and 1 sec Off		Control board malfunction
Module Phase Current Protection - Frequency Decrease/Limit Mode	En			Outdoor control board malfunction
Module Temperature Protection - Frequency Decrease/Limit Mode	EU		11 flashes and 1 sec Off	1) IPM module over heating or malfunctioning 2) Improper voltage at IPM Module
Refrigerant Leakage Protection	F0		9 flashes and 1 sec Off	1) refrigerant leak(s) 2) Indoor coil temperature sensor no calibrated 3) Refrigerant flow is restricted (ex. valve, exv, debris)
Indoor Ambient Temperature Sensor Malfunction	F1			1) Loose or bad connection between sensor and control board 2) Indoor ambient temperature sensor damaged 3) Control board malfunction
Indoor Coil Temperature Sensor Malfunction	F2			1) Loose or bad connection between sensor and control board 2) Indoor coil temperature sensor damaged 3) Control board malfunction
Outdoor Ambient Temperature Sensor Malfunction	F3		6 flashes and 1 sec Off	1) Loose or bad connection between sensor and control board 2) Outdoor ambient temperature sensor damaged 3) Control board malfunction
Outdoor Coil Temperature Sensor Malfunction	F4		5 flashes and 1 sec Off	1) Loose or bad connection between sensor and control board 2) Outdoor coil temperature sensor damaged 3) Control board malfunction
Outdoor Discharge Temperature Sensor Malfunction	F5		7 flashes and 1 sec Off	1) Loose or bad connection between sensor and control board 2) Discharge temperature sensor damaged 3) Control board malfunction
Compressor Overload Protection - Frequency Decrease/Limit Mode	F6		3 flashes and 1 sec Off	1) Incorrect refrigerant charge 2) Metering device malfunction 3) Compressor malfunction
Oil Return Protection - Frequency Decrease/Limit Mode	F7			Normal function status code only
System Current Overload Protection - Frequency Decrease/Limit Mode	F8		1 flashes and 1 sec Off	1) Input voltage too low 2) System pressure too low
High Compressor Discharge Temperature - Frequency Decrease/Limit Mode	F9		2 flashes and 1 sec Off	1) Cooling load is too great 2) Outdoor ambient temperature too high 3) Refrigerant charge too low 4) Metering device malfunction

DIAGNOSTIC CODES



Malfunction Name	Indoor Unit Display	Outdoor Unit Indicators		Possible Causes
		Yellow	Red	
Indoor Coil Freeze Protection - Frequency Decrease/Limit Mode	FH		4 flashes and 1 sec Off	1) Indoor coil has not reach minimum heating temperature 2) Indoor ambient is abnormally cold 3) Indoor control board malfunction
Pump Down or Gathering Refrigerant Status	Fo	17 flashes and 1 sec Off		Optional Service Mode
High Indoor Coil Temperature in Heating- Frequency Decrease/Limit Mode	H0			1) Incorrect refrigerant charge 2) Metering device malfunction 3) Compressor malfunction
Defrost Mode in Heating	H1			Operation status
Compressor Overload Protection	H3	8 flashes and 1 sec Off		1) Wiring terminal OVC-COMP is loose 2) Refer to the malfunction analysis in Service Manual
Compressor Overload Protection	H4	6 flashes and 1 sec Off		1) Incorrect refrigerant charge 2) Metering device malfunction 3) Compressor malfunction
IPM Module Protection	H5	4 flashes and 1 sec Off		1) IPM module over heating 2) Improper or Low voltage at the IPM module 3) IPM module malfunction
Indoor DC Fan Motor Malfunction	H6			1) Loose connections between fan motor and control board 2) Fan motor or blower wheel bearings malfunction 3) Control board malfunction
Compressor De-Synchronized Malfunction	H7			1) Compressor voltage is not balance 2) Control board malfunction 3) Compressor malfunction
Power Factor Correction (PFC) Protection	HC	14 flashes and 1 sec Off		1) Mis-wiring of the reactor filter and PFC capacitor 2) Reactor filter or PFC capacitor malfunction 3) Control board malfunction
Compressor Demagnetization Protection	HE			Compressor malfunction
Outdoor Fan Motor Malfunction	L3		14 flashes and 1 sec Off	1) Loose connections between fan motor and control board 2) Fan motor malfunction 3) Control board malfunction
High Input Power Protection	L9	9 flashes and 1 sec Off		1) Compressor malfunction 2) Power circuit malfunction
Start-Up Malfunction	LC			1) Over charged with refrigerant 2) Control board malfunction 3) Compressor malefaction
Compressor phase-lacking/ phase-inverse protection	Ld			Hardware malfunction

DIAGNOSTIC CODES



Malfunction Name	Indoor Unit Display	Outdoor Unit Indicators		Possible Causes
		Yellow	Red	
Incompatible Indoor and Outdoor Units	LP	16 flashes and 1 sec Off		Indoor and outdoor units are not compatible
Defrosting Status	note 1	16 flashes and 1 sec Off		
Compressor Phase Current Protection	P5			1) IPM module malfunction 2) Outdoor control board malfunction 3) Compressor malfunction
Module Temperature Sensor Malfunction	P7			Outdoor control board malfunction
Module Temperature Protection	P8			1) Lack of thermal grease on IPM module 2) Heat sink (radiator) not tightly mounted 3) Control board malfunction
High DC Bus Voltage Protection	PH	13 flashes and 1 sec Off		1) Supply voltage on L1 and N is above 265Vac 2) Capacitor on control board malfunction 3) Outdoor control board malfunction
Low DC Bus Voltage Protection	PL	12 flashes and 1 sec Off		1) Supply voltage on L1 and N is below 150Vac 2) Capacitor on control board malfunction 3) Outdoor control board malfunction
Capacitor Charging Malfunction	PU			Capacitor malfunction
Compressor Phase-Current Detection Malfunction	U1			Outdoor control board malfunction
DC Bus Voltage Level Dropping Malfunction	U2			Unstable supply voltage
Current Detection Malfunction	U3			Outdoor control board malfunction
Reversing Valve Malfunction	U4			1) Voltage to reversing valve is less than 175V 2) Loose connections between reversing valve and control board 3) Reversing valve solenoid malfunction
Input Current Detection Malfunction	U5			Outdoor control board malfunction
The four-way valve is abnormal	U7			Hardware malfunction
Zero cross detection circuit malfunction(for indoor unit)	U8			Hardware malfunction
Zero cross detection malfunction	U9			Outdoor control board malfunction

Notes: 1) During defrosting process, the heating indicator is on for 10s and off for 0.5s.
2) Refer to Service Manual for additional information.



LIMITED WARRANTY STATEMENT

FOR WARRANTY SERVICE OR REPAIR:

Contact your installing contractor. You may find the installer's name on the equipment or in your Owner's packet. Complete product registration below and send back by email to Info@StealthComfort.com

PRODUCT REGISTRATION

Model No. _____

Serial No. _____ Date of Installation _____

Owner Name _____

Address of Installation _____

Installing Contractor _____

Address _____

Phone No. / E-mail _____

STEALTH (1HVAC Energy LLC) warrants this product against failure due to defect in materials or workmanship under normal use and maintenance as follows. All warranty periods begin on the date of original installation. If the date cannot be verified, the warranty period begins one hundred twenty (120) days from date of manufacture. If a part fails due to defect during the applicable warranty period, Company will provide a new or remanufactured part, at Company's option, to replace the failed defective part at no charge for the part. This limited warranty is subject to all provisions, conditions, limitations and exclusions listed below.

- A warranty period of Five (5) years on all parts to the original registered end user.
- A warranty period of seven (7) years on the compressor.
- Online registration of this product at (Stealthcomfort.com/warranty-information) extends the warranty as follows - one year unit replacement and twelve (12) year compressor warranty.
- Warranty applies only to products remaining in their original installation location.
- Defective parts must be returned to the distributor.

LIMITATIONS OF WARRANTIES: ALL IMPLIED WARRANTIES AND/OR CONDITIONS (INCLUDING IMPLIED WARRANTIES OR CONDITIONS OF MERCHANTABILITY AND FITNESS FOR A PARTICULAR USE OR PURPOSE) ARE LIMITED TO THE DURATION OF THIS LIMITED WARRANTY, SOME STATES OR PROVINCES DO NOT ALLOW LIMITATIONS ON HOW LONG AN IMPLIED WARRANTY OR CONDITION LASTS, SO THE ABOVE MAY NOT APPLY TO YOU. THE EXPRESS WARRANTIES MADE IN THIS WARRANTY ARE EXCLUSIVE AND MAY NOT BE ALTERED, ENLARGED, OR CHANGED BY ANY DISTRIBUTOR, DEALER, OR OTHER PERSON, WHATSOEVER.

THIS WARRANTY DOES NOT COVER:

1. Labor or other costs incurred for diagnosing, repairing, removing, installing, shipping, servicing or handling of either defective parts, or replacement parts, or new units.
2. Product cleaning required prior to warranty service and repair.
3. Normal maintenance as outlined in the installation and servicing instructions or Owner's Manual, including filter cleaning and/or replacement and lubrication.
4. Failure, damage or repairs due to faulty installation, misapplication, abuse, improper servicing, unauthorized alteration or improper operation.
5. Failure to start due to voltage conditions, blown fuses, open circuit breakers, or damages due to the inadequacy or interruption of electrical service.
6. Failure or damage due to floods, winds, fires, lightning, accidents, corrosive environments (rust, etc.) or other conditions beyond the control of the Company.
7. Failure or damage of coils or piping due to corrosion on installations within one (1) miles of sea coast or corrosive body.
8. Parts not supplied or designated by Company, or damages resulting from their use.
9. Products installed outside the 48 contiguous United States, except the District of Columbia and Hawaii.
10. Electricity or fuel costs, or increases in electricity or fuel costs from any reason whatsoever, including additional or unusual use of supplemental electric heat.
11. Any cost to replace, refill or dispose of refrigerant, including the cost of refrigerant.
12. Shipping damage or damage as a result of transporting the unit.
13. Accessories such as condensate pumps, line sets and so forth are not covered.
14. Any special, indirect or consequential property or commercial damage of any nature whatsoever. Some states or provinces do not allow the exclusion of incidental or consequential damages, so the above limitation may not apply to you.
15. Consumable components, such as air filters, are not covered under parts warranty.

This warranty gives you specific legal rights, and you may also have other rights which vary from state to state. In jurisdictions where warranty benefits conditioned on registration are prohibited by law, registration is not required, and the STANDARD warranty period shown above will apply.