

# BLASTER BOARDS®

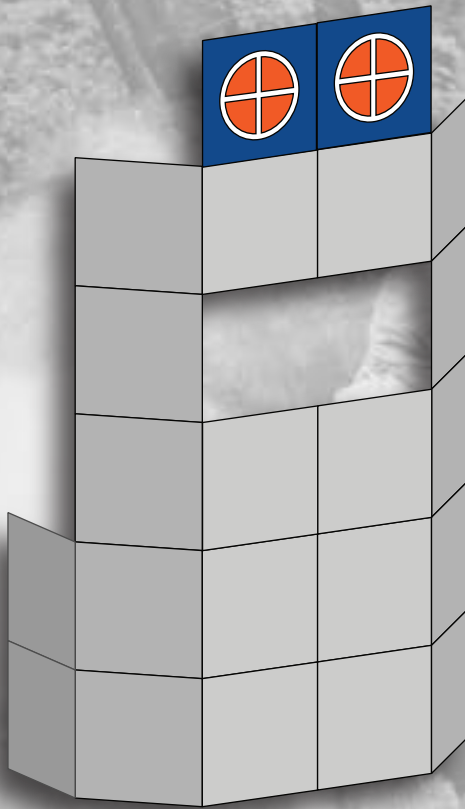

## BUILD DIRECTIONS

BUILD SIZE: [ 1 ] PACK/S

IDEAL FOR: [ X ] OPTIMAL COVERAGE  
[    ] OPTIMAL STRENGTH

CAUTION: DO NOT CLIMB OR ADD WEIGHT ONTO BUILT STRUCTURES. IT COULD CAUSE A BAD TIME.

[BLASTER-BOARDS.COM](http://BLASTER-BOARDS.COM)

### Straight Connection

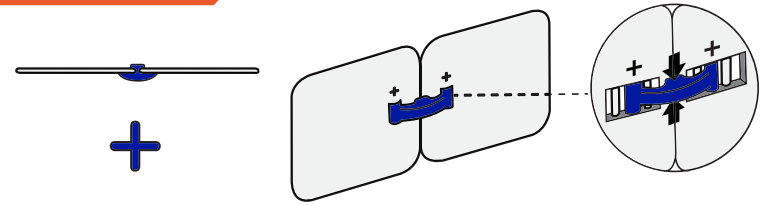

### 30° Connection

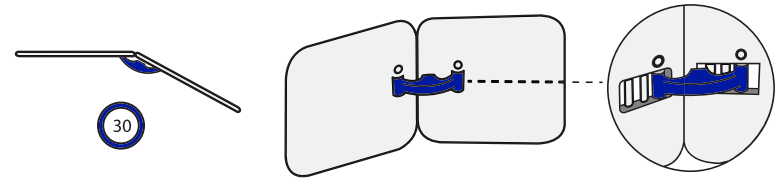

### 45° Connection

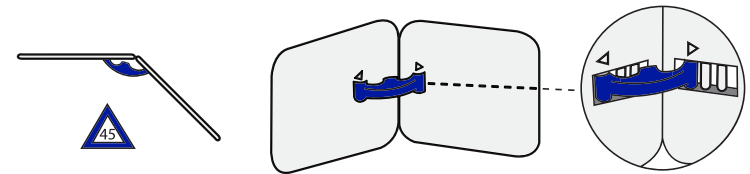

### 90° Connection

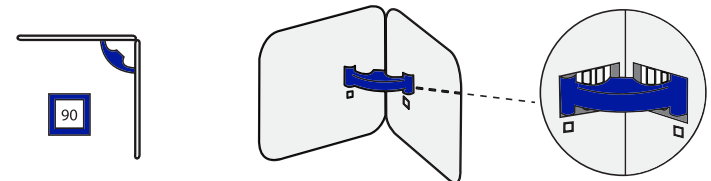

### No Connector

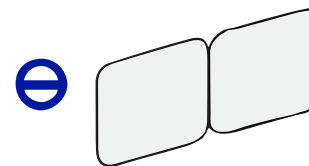

### Not Attached

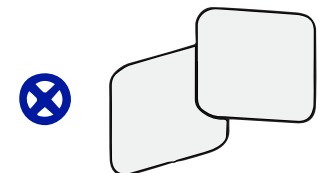

1

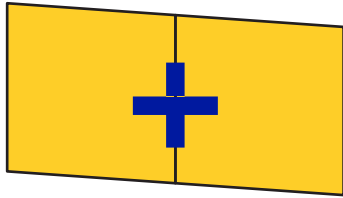

2

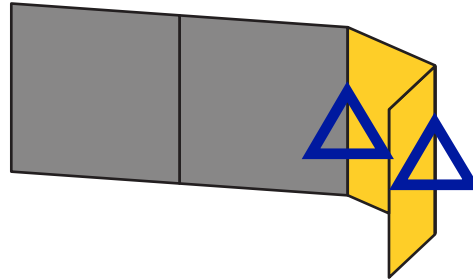

3

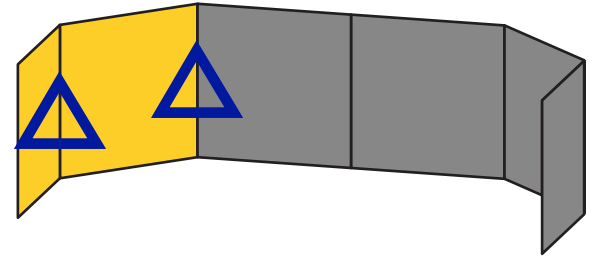

4

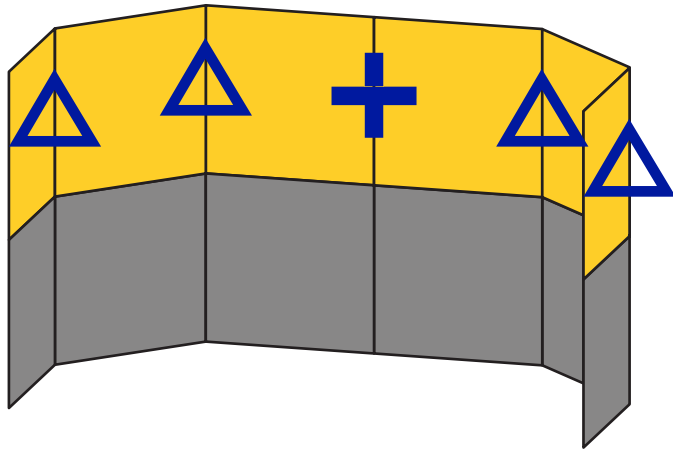

5

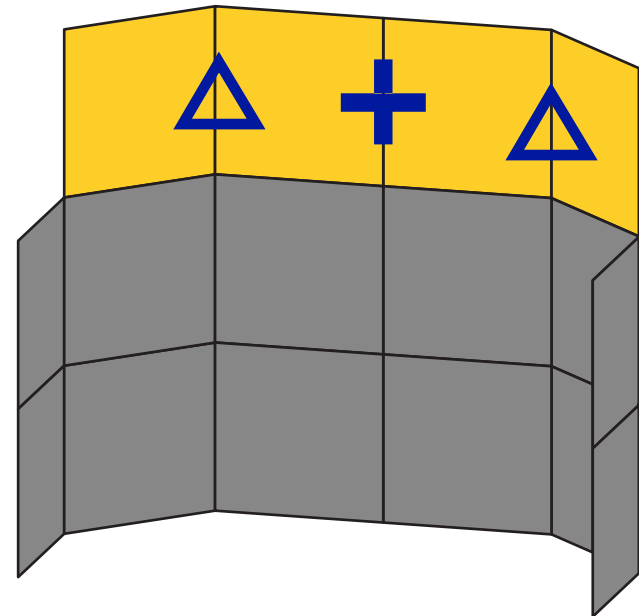

6

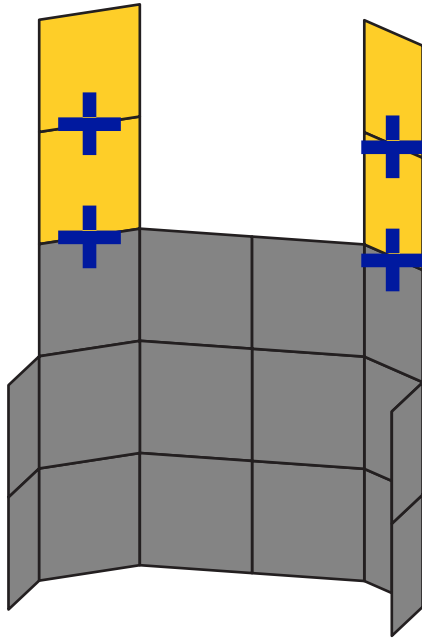

7

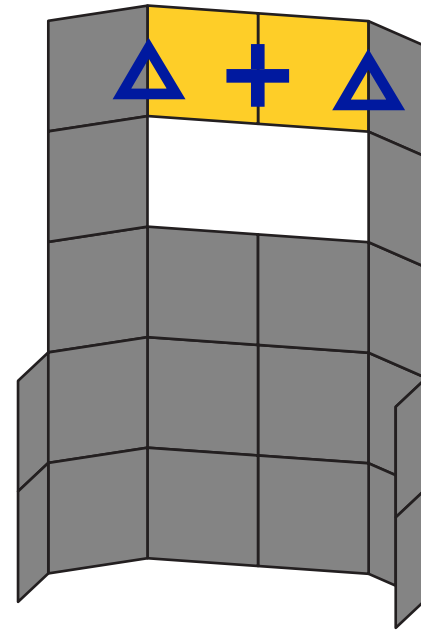

8

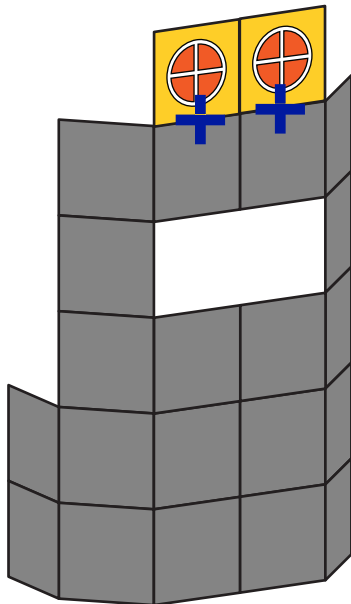

We love showing off your creativity!  
Tag your photos with: **#BlasterBoards**