

weldtech

WT35P

35A Inverter Plasma Cutter

WORKSHOP RANGE



OPERATING INSTRUCTIONS

www.weldtech.net.nz



We Appreciate Your Business!

Congratulations on your new Weldtech product!

The Weldtech range from Euroquip uses latest technology design and engineering to produce welding products that combine market leading value and features with durability. Designed for discerning operators who seek professional results and product quality without the price tag of a full professional setup. Design emphasis is placed on simple, functional design and operation. Weldtech product is subject to stringent quality control and designed and manufactured to NZ & Australian standards.

Common use of Weldtech products include:

- Light Engineering
- Automotive
- Home/hobby Engineering
- Farming
- Maintenance & Repairs

For industrial welding solutions, check out the Strata range from Euroquip:

www.strata.co.nz

Euroquip is a market leading provider of innovative power equipment solutions to a wide range of industries across New Zealand and Australia. Key product categories are; welding equipment, air compressors, power generators and cleaning equipment.

Euroquip's slogan is 'empowering industries', find out more about the advantage Euroquip brings at **www.euroquip.co.nz**.

Providing exceptional product support is a key component of Euroquip's market leading customer advantage focus. As part of this program, it is required for all products to be registered with Euroquip to qualify for product support. Products not registered with Euroquip are supported by a base 12 month warranty only. Spare parts and technical support will not be available for an unregistered product outside of this base warranty period. If a Euroquip dealer has not already registered your product, please register it online at www.euroquip.co.nz. To request a physical registration form, please contact Euroquip customer service on 0800 387 678.

Contents

TECHNICAL PARAMETERS -----	5
KNOW YOUR MACHINE -----	6
TIPS & TRICKS-----	7
QUICK START GUID-----	7
BASIC OPERATION-----	8
PLASMA CUTTING GUIDE-----	8
ACCESSORIES & CONSUMABLES-----	10
INSTALLATION AND CONNECTION-----	11
KNOWLEDGE & RESOURCES-----	13
CARE & MAINTENANCE-----	13
SAFETY-----	13
WARRANTY-----	18

weldtech

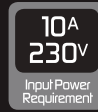

WT35P

WORKSHOP SERIES

35A - INVERTER PLASMA CUTTER

The WT35P utilises the latest in digital control and plasma cutting technology for smooth and easy cutting

- Cutting edge IGBT technology
- Plasma cut up to 10mm
- Digital display for accurate feedback and setting of parameters
- 100% duty cycle @20A
- Lightweight and robust construction at only 7kg
- Cuts mild steel, stainless steel, aluminium and any electrically conductive material.

INCLUDES
PT-31 Plasma torch,
Earth Leads,
Gas Hose,
Air filter/ regulator

Specifications

Rated input voltage (V)	AC230V 50Hz
Rated input power (KW)	5.75
CUT Current range (A)	10-35
No-load voltage (V)	320
Cooling mode	Air cooling
Rated duty cycle	60% @25A
Efficiency (%)	85
Power factor	0.93
Protection class	IP23
Insulation class	H
Size (mm)	380*155*260
Weight (Kg)	7
Post-flow time(s)	15



35A

Cuts up to 10mm

18 MONTH* WARRANTY
with product registration



With 10A plug - Great for home or workshop power supplies.

TECHNICAL PARAMETERS

Table 1-1: General technical parameters

MODEL	WT35P
Rated input voltage (V)	AC230V 50Hz
Rated input power (KW)	5.75
CUT Current range (A)	10-35
No-load voltage (V)	320
Cooling mode	Air cooling
Rated duty cycle	60% @25A
Efficiency (%)	85
Power factor	0.93
Protection class	IP23
Insulation class	H
Size (mm)	380*155*260
Weight (Kg)	7
Post-flow time(s)	15

Box includes:

WT35P Plasma Cutting Machine	X 1
PT-31 Plasma Cutting Torch	x 1
Earth leads	x 1
Gas hose	x 1



KNOW YOUR MACHINE

* Denotes more detailed explanation of function below.

Rear

1. Input Power Lead
2. Power Switch
3. Compressed Air Inlet Fitting

Front

4. Air Pressure Gauge
5. LCD Current Meter
6. Error/ Overload Indicator*
7. Cutting Current Adjustment Knob
8. 2T/4T Trigger Mode Selector*
9. Air Control Run/ Set Mode Selector *
10. Earth Lead Connection Socket
11. Torch Switch Connection Socket
12. Plasma Torch Connection
13. Water Condensate Filter Drain (Obscured Underneath)

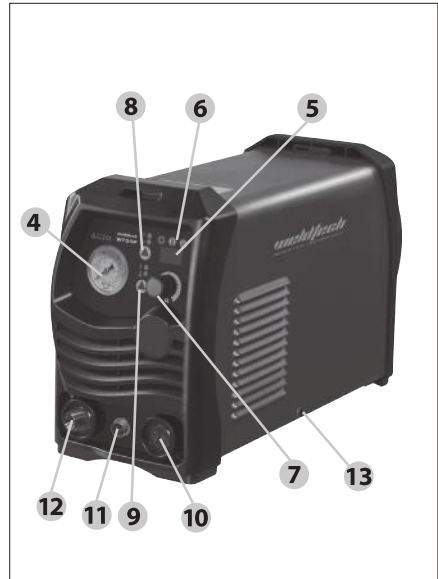
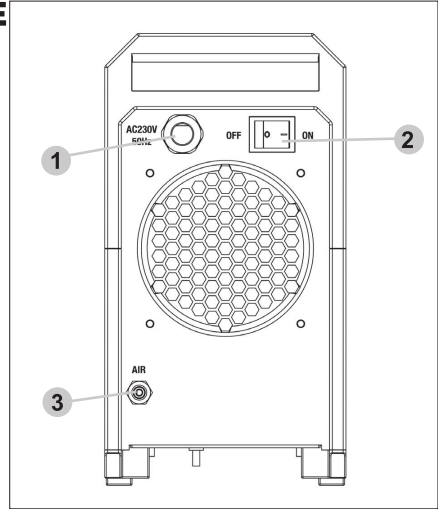

Controls Explained

2T/4T Trigger Control (9)

In 2T mode the trigger is pulled and held on to activate the cutting circuit, when the trigger is released, the cutting circuit stops.

4T is known as 'latching' mode. The trigger is pulled once and released to activate the cutting circuit, pulled and released again to stop the cutting circuit. This function is useful to longer cuts as the trigger is not required to be held on continuously.

Overload/ Error Indicator (7)

This lights when over voltage, over current or electrical overheating (due to exceeding duty cycle) is detected and protection is activated. When protection is activated, cutting output will be disabled until the safety system senses the overload has reduced sufficiently and indicator lamp goes out. May also trigger if machine experiences an internal power circuit failure.

Air Control Run/ Set Mode Selector (10)

When set to 'GAS', the compressed air control valve is open continuously. This is useful for testing and setting the air pressure without having to activate the trigger circuit. 'CUT' setting is normal operation.

Air Regulator Pressure Adjustment (5)

Correct air pressure is critical for plasma cutting. Incorrect air pressure will cause poor cut quality, lack of cutting power, damage to the plasma torch and consumables and potentially damage the power source. Optimum air pressure is between 4 and 5 bar (60-75psi).

Air pressure should be set with the air flowing through the torch, as the pressure with the air flowing will normally be less than static pressure, due to flow losses through the torch system. To unlock the pressure regulator knob in order to adjust it, pull the knob upwards. Once the pressure is set correctly, push the knob down again to lock it into place.

Tips & Tricks

Air Filter/ Water Separator

As with correct air pressure, clean, dry air is critical for plasma cutting machine performance and reliability. The WT35P is designed with an internal air filtration/ moisture separator to assist with providing suitable air supply. The moisture separator is self-draining, the water drain tube exits out the bottom of the machine casing (14). It is normal to see moisture coming from this drain tube. If excessive amounts of water or oil are being produced from the condensate drain, the compressed air supply should be checked for issues.

Plasma Torch Consumables

It is very important to recognise that plasma torch consumables wear as part of normal operation and should be replaced in a timely manner. Operating a torch with worn consumables will cause poor cutting results and possible damage to the torch and machine itself. Damage caused by untimely replacement of consumables will not be covered by warranty.

Use the following guidelines to determine when consumables should be replaced:

Cutting Tips: the cutting tip has a small calibrated orifice that the plasma passes through. If the orifice becomes partially blocked, deformed or enlarged, the cutting tip should be replaced.

Electrodes: the electrode has a small silver 'hafnium' insert in the end of the tip. This is what generates the plasma ions. Once the hafnium insert is used up or is damaged the tip must be replaced.

Swirl Ring/Retaining Cap: these should be replaced if broken, chipped, cracked or badly heat damaged.

Tips and Electrodes wear reasonably evenly and it is normal practice to replace them both together. If a new tip is inserted with a worn electrode the tip will wear much more quickly than if the electrode was also replaced at that same time.

If tips or electrodes are wearing much faster than the other component it is likely to be caused by one of the following: poor operator technique, incorrect air supply or damaged torch head.

It is also very important to only use genuine Strata or Weldtech consumables and parts for the WT35P plasma torch. They are engineered to suit the machine and non-genuine items may cause lack of performance, short life span, torch and machine damage and void warranty.

Duty Cycle Rating

Cutting duty cycle is the percentage of actual cutting time that can occur in a ten minute cycle. E.g. 20% at 40 amps - this means the plasma cutter can operate at 40 amps for 2 minutes and then the unit will need to be rested for 8 minutes.

All duty cycle ratings are based on an ambient air temperature of 40°C with 50% humidity, which is the international standard for such a rating. In an environment with temperatures exceeding 40°C, the duty cycle will be less than stated. In ambient temperature less than 40°C, duty cycle performance will be higher.

Quick Start Guide

Electrical Power Supply

The WT35P is designed to operate on a 10A 230V AC power supply. If an extension cord must be used, it should be a heavy duty version with a minimum cable core size of 2.5mm². It is recommended to use the Euroquip industrial duty 15A extension lead, part number 16895.

Compressed Air Requirements

A reliable and consistent supply of clean dry compressed air is essential for proper operation of the WT35P. Although the machine contains its own internal air supply filtration system, it is recommended the compressed air supply should have external filtration in the line feeding the machine, both a standard water trap (sintered bronze filter) and also a coalescing filter (for oil in air).

The air requirement is a minimum of 120 l/min (4.5cfm) Free Air Delivery (FAD) at 75 PSI pressure. This normally means the compressor must be a belt drive model or if a direct drive it must have a motor power of 2.5HP or greater.

The air must be dry and free of oil and moisture (normally a symptom of older, worn out compressors). The air hose must also be of sufficient size (3/8"/10mm minimum) to supply the machine.

Operating Environment

Adequate ventilation is required to provide proper cooling for the WT35P. Ensure that the machine is placed on a stable level surface where clean cool air can easily flow through the unit. The WT35P has electrical components and control circuit boards which may be damaged by excessive dust and dirt, so a clean operating environment is important for reliable product life.

Basic Operation

- 1.1 Connect the earth cable quick connector to the earth connection socket (11) Connect the earth clamp to the work piece. Contact with the work piece must be firm contact with clean, bare metal, with no corrosion, paint or scale at the contact point.
- 1.2 Connect the rolling nut plasma torch fitting to the machine plasma torch power/air outlet (13). Ensure it is tightened firmly by hand. Connect the plasma torch switch lead to the machine socket (12)
- 1.3 Connect the machine to suitable mains power using the mains input power lead (1). Switch the mains power switch (2) to 'on' to power up the machine.

- 1.4 Connect the compressed air supply to the machine inlet (3). Check the air pressure (4). Trigger the air flow using the 'gas' function (10), check the air pressure again and adjust if necessary. Return the setting to 'cut'.

- 1.5 Select the output current using the current control knob (8). You are now ready to plasma cut!

Plasma Cutting Guide

Effect of Cutting Speed

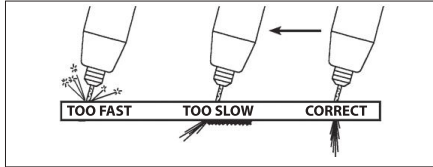

Piercing Technique

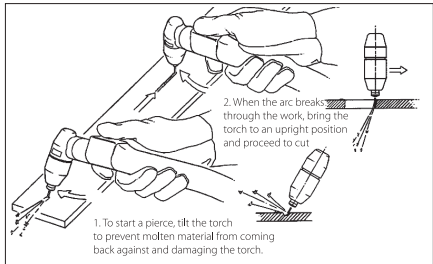

NOTE: Keep moving while cutting. Cut at a steady speed without pausing. Maintain the cutting speed so that the arc lag is 10° to 20° behind the travel direction. Use a 5° - 15° leading angle in the direction of the cut.

Operating Techniques

- Piercing** - Materials (up to 3.2mm/1/8in. thick) may be pierced with the torch touching the work. When piercing thicker materials (up to 4.8mm stainless or carbon steel) at an angle, position the torch 0.5mm (.02") above the work piece.

It is advisable when piercing thicker materials to drill a small pilot/starting hole in the work piece which makes it a lot easier and gives increased tip life. Start the cutting arc, then immediately raise the torch to 1.6mm (1/16") stand-off and move the torch along the cut path. This will reduce the chance of spatter from entering the torch and prevent the possibility of welding the tip to the plate. The torch should be angled at about 30° when starting to pierce, and then straightened after accomplishing the pierce.

- Grate Cutting** - For rapid restarts, such as grate or heavy mesh cutting, do not release the torch switch. This avoids the 2 second pre-low portion of the cutting cycle.
- Edge Starting** - For edge starts, hold the torch perpendicular to the work piece with the front of the tip near (not touching) the edge of the work piece at the point where the cut is to start. When starting at the edge of the plate, do not pause at the edge and force the arc to 'reach' for the edge of the metal.

Establish the Cutting Arc as Quickly as Possible.

Cutting Speed Guide		
Material	Thickness (mm)	Cutting Speed (mm/s)
Carbon Steel (AISI 1020)	1.6	150
	3.2	50
	6.4	20
Stainless Steel (AISI 304)	1.6	140
	3.2	40
	6.4	15
Aluminium (6061)	1.6	190
	3.2	85
	6.4	30

NOTE: The speeds given here are typical for best quality cuts. Your actual speeds may vary depending on material composition, surface condition, operator technique, etc.

If cutting speed is too fast, you may lose the cut. With slower speeds excessive dross may accumulate. If speed is too slow, the arc may extinguish. Air cutting typically produces a rough face on stainless steel and aluminium.

- Drag Cutting** - Position torch tip slightly above work piece, press torch switch and lower torch tip forward work piece until contact is made and cutting arc is established. After cutting arc is established, move the torch in the desired direction keeping the torch tip slightly angled, maintaining contact with the work piece.

Avoid moving too fast as would be indicated by sparks radiating from the topside of the work piece. Move the torch just fast enough to maintain sparks concentration at the underside of the work piece and making sure the material is completely cut through before moving on. Adjust drag speed as desired/ required.

- Direction of Cut** - The plasma gas stream swirls as it leaves the torch to maintain a smooth column of gas. This swirl effect results in one side of a cut being more square than the other. Viewed along the direction of travel, the right side of the cut is more square than the left.

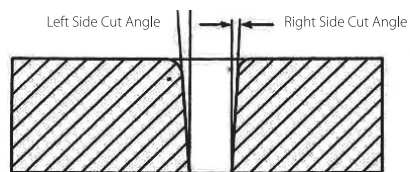

To make a square-edged cut along an inside diameter of a circle, the torch should move counter clockwise around the circle. To keep the square edge along an outside diameter cut, the torch should travel in a clockwise direction.

- Quality Cuts** – Dross (slag) is the excess material that spatters and builds up on the underside of the work-piece as you cut. Dross occurs when the operating procedure and technique is less than optimal. It will require practice and experience to obtain cuts

without dross. Although less than optimal cuts will contain dross, it is relatively easy to remove by breaking it off using pliers or chipping off with a chisel or scraping or grinding the finished cut as needed and is generally only a minor inconvenience.

A combination of factors contributes to the build-up of dross. They include; material type, material thickness, amperage used for the cut, speed of the torch across the work-piece, condition of the torch tip, input line voltage, air pressure, etc. Generally there is an inversely proportional relationship between output current and speed of cut. Do not use more output current than is necessary and adjust speed of cut toward minimizing dross build-up on underside of cut. Experiment with adjusting current and speed to minimize dross.

When dross is present on carbon steel, it is commonly referred to as either 'high speed, slow speed, or top dross'. Dross present on top of the plate is normally caused by too great a torch to plate distance.

'Top dross' is normally very easy to remove and can often be wiped off with a welding glove. 'Slow speed dross' is normally present on the bottom edge of the plate. It can vary from a light to heavy bead, but does not adhere tightly to the cut edge, and can be easily scraped off. 'High speed dross' usually forms a narrow bead along the bottom of the cut edge and is very difficult to remove. When cutting troublesome steel, it is sometimes useful to reduce the cutting speed to produce 'slow speed dross'. Any resultant clean up can be accomplished by scraping, not grinding.

Spare Parts for WT35P

Part #:	Description:
18097	Air Pressure Regulator Assembly
18098	Air Pressure Gauge
18101	Gas Solenoid 220V
18105	Main Power Switch Parts
CP1625	Cable Plug - 15-25mm ² (8.5mm dia pin)
WT18204	PT-31 Shield cap (2pk)
WT18205	PT-31 Electrode - std. (5pk)
WT18785	PT-31 Swirl baffle (2pk)
WT18866	PT-31 Nozzle - std. (5pk)
WT19682	PT-31 Nozzle - long (5pk)
WT19683	PT-31 - Long Electrode (5pk)
WT45065	PT-31 O-ring (2pk)
RW30C-35	Complete Replacement Plasma Torch
ACR2608	1/4" Male ARO Plug
A200EC	200A Earth Clamp
AEL1625	Earth Lead 16mm ² cable, 16-25mm Plug, 3m Heavy Duty Earth Clamp
16895	15m H/D 15A Extension Lead (3 x 2.5mm ² wiring)
PDL15	3 Pin Plug, 15A 250V - Straight
16896	2m 15A H/D Molded Plug & Lead, (3x2.5mm ² wiring)

Accessories & Consumables

Refer to page 4 for related accessories for this machine or visit www.weldtech.co.nz for a full range of consumables and accessories.

PT-31 Torch Compatible Consumables

1	WT45065	O-Ring
2	WT18205 Electrode	- Std.
2	WT19683 Electrode	- Long
3	WT18785 Swirl	Baffle
4	WT18866 Nozzle	- Std.
4	WT19682 Nozzle	- Long
5	WT18204 Shield	Cap

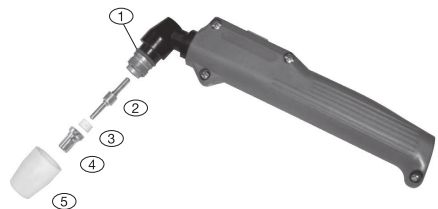

INSTALLATION AND CONNECTION

2.1 Installation requirements

1) Connection of input cable

In order to ensure personal safety and avoid electric shock, please send the product power plug the grounding and wiring box grounding device, reliable grounding protection.

A primary power supply cable is available for this cutting machine. Connect the power supply cable to the rated input power. The primary cable should be tightly connected to the correct socket to avoid oxidization. Check whether the voltage value varies in acceptable range with a multi-meter.

The cross section of the leads used in the switching box should meet the requirements of the maximum input capacity of the machine.

Install a line disconnecting switch at each power supply, so that the power supply can be cut off immediately in case of an emergency. The disconnecting value of the switch should be equal to or greater than the continuous rating of the fuse.

2) Connection of output cable

Connect the plug on the cutting torch to the CUT torch socket, and tighten it clockwise to avoid gas leakage.

3) Connection of earth cable

Insert the quick plug on the earth cable into the output terminal “+” on the front panel of the machine, and tighten it clockwise.

2.2 Precautions

- 1) Make sure the place to install the machine can bear the weight of the cutting machine.
- 2) Do not install the machine at places where water droplet splash may be produced, such as near water pipes.
- 3) Cutting should be carried out in dry environment with humidity of 90% or less.
- 4) The temperature of the working environment should be between -10 and 40.
- 5) Avoid cutting in the open air unless sheltered from sunlight and rain. Keep it dry at all times and do not place it on wet ground or in puddles.
- 6) Avoid cutting in dusty area or environment with corrosive chemical gas.
- 7) Do not carry out cutting with the cutting machine placed on a platform with a pitch greater than 10°.

Overcurrent/overvoltage/overheating protection circuit is installed in this machine. When the mains voltage, output current or inner temperature exceeds the set standard, the machine will stop automatically. However, excessive use (e.g. too high voltage) of machine may also damage the machine, so please note:

A sudden halt may occur with the LED on the front panel on while the machine is of over-load status. Under this circumstance, it is unnecessary to restart the machine. Keep the built-in fan working to lower the temperature inside the machine. Cutting can be continued after the inner temperature falls into the standard range and the LED is off.



Well ventilated

This cutting machine can create powerful cutting current and has strict cooling requirements that cannot be met with natural ventilation. Therefore the built-in fan is very important in enabling the machine to work stable with effective cooling. The operator should make sure that the louvers be uncovered and unblocked. The minimum distance between the machine and nearby objects should be 25cm.



Overvoltage is forbidden

This machine is of automatic mains voltage compensation, which ensures that the cutting current varies within the given range. In case that the input mains voltage exceeds the tolerance value, it would possibly damage the machine. The operator should understand this circumstance fully and adopt relevant precautions.



Overload is forbidden

Remember to observe the max load current at any moment. Make sure that the cutting current should not exceed the maximum load current. Overload could obviously shorten the machine's lifespan, or even damage the machine

Knowledge & Resources

Please refer to Euroquip website
[www.euroquip.co.nz/ Downloads.html](http://www.euroquip.co.nz/Downloads.html)
for knowledgebase articles & operation videos.

Care & Maintenance

Keep your Plasma Cutter in Top Condition

The WT35P does not require any special maintenance, however the user should take care of the machine as follows:

- Regularly clean the ventilation slots.
- Keep the casing clean.
- Check all cables before use.
- Check work leads/clamps and torches before use.
- Replace worn earth clamps that do not provide a good connection.
- Replace worn consumable parts in a timely manner.
- Use a soft cloth or brush to clean electrical components.
- Do not use liquid cleaning products, water or especially solvents.
- Do not use compressed air to clean electrical components as this can force dirt and dust further into components, causing electrical short circuits.
- Check for damaged parts. Do not use the plasma cutter with damaged parts.
- A damaged plasma cutter must be carefully checked by a qualified person to determine that it will operate properly. Check for breakage of parts, mountings and other conditions that may affect its operation. An authorised service centre should properly repair a damaged part. Have your machine repaired by an expert.

This appliance is manufactured in accordance with relevant safety standards. Only experts must carry

out repairing of electrical appliances, otherwise considerable danger for the user may result. Use only genuine replacement parts. Do not use modified or non-genuine parts.

Storing the Plasma Cutter

When not in use the plasma cutter should be stored in a dry and frost-free environment.

 **WARNING!** Before performing cleaning/maintenance, replacing cables / connections, make sure the welding machine is switched off and disconnected from the power supply.

Safety

Store and Retain this Manual

Retain this manual for the safety warnings and precautions, assembly, operating, inspection, maintenance and cleaning procedures. Write the product's serial number into the NOTES section at the rear, and keep this manual and the receipt in a safe and dry place for future reference.

Important Safety Information

Failure to follow the warnings and instructions may result in electric shock, fire, serious injury and/or death. Save all warnings and instructions for future reference.



This is the safety alert symbol to alert you to potential personal injury hazards. Obey all safety messages that follow this symbol to avoid possible injury or death.

 **DANGER!** indicates a hazardous situation which, if not avoided, will result in death or serious injury.

 **WARNING!** indicates a hazardous situation which, if not avoided, could result in death or serious injury.

 **CAUTION,** used with the safety alert symbol, indicates a hazardous situation which, if not avoided, could result in minor or moderate injury.

NOTE, used to address practices not related to personal injury.

General Safety Warnings

- 1. Maintain labels and nameplates on the plasma cutter** These carry important information. If unreadable or missing, contact Euroquip for a replacement.
- 2. Avoid unintentional starting.** Make sure the plasma cutter is setup correctly and you are prepared to begin work before turning on the plasma cutter.
- 3. Unplug before performing maintenance.** Always unplug the plasma cutter from its electrical outlet before performing any inspection, maintenance, or cleaning procedures.
- 4. Never leave the plasma cutter unattended whilst plugged in to power.** Turn power off before leaving the plasma cutter unattended.
- 5. Do not touch live electrical parts.** Wear dry, insulating gloves. Do not touch the electrode or the conductor tong with bare hands. Do not wear wet or damaged gloves.
- 6. Protect yourself from electric shock.** Do not use the plasma cutter outdoors in wet conditions.
- 7. Avoid inhaling dust.** Some dust created by power sanding, sawing, grinding, drilling, cutting, welding and other construction activities, contain chemicals known to cause cancer, birth defects or other harm. Your risk from these exposures varies, depending on how often you do this type of work. To reduce your exposure to these chemicals, work in a well-ventilated area, and work with approved safety equipment, such as dust masks that are specially designed to filter out microscopic particles.
- 8. People with pacemakers should consult their physician(s) before using this machine.**



WARNING!

Electromagnetic fields in close proximity to a heart pacemaker could cause interference, or

failure of the pacemaker. The use of a plasma cutter is **NOT RECOMMENDED** for pacemaker wearers. Consult your doctor.

- 9. Ensure that the unit is placed on a stable location before use.**



WARNING!

If this unit falls while plugged in, severe injury, electric shock, or fire may result.

- 10. Transportation Methods** Lift unit with the handles provided, or use a handcart or similar device of adequate capacity. If using a fork lift vehicle, secure the unit to a skid before transporting.



CAUTION!

Disconnect input power conductors from de-energized supply line before moving the plasma cutter

- 11. Exercise good work practices.** The warnings, precautions, and instructions discussed in this instruction manual cannot cover all possible conditions and situations that may occur. It must be understood by the operator that common sense and caution are factors which cannot be built into this product, but must be considered by the operator.

Plasma Cutter Safety Instructions & Warnings



WARNING!

Protect yourself and others from possible serious injury or death. Keep children away. Read the operating/Instruction manual before installing, operating or servicing this equipment. Have all installation, operation, maintenance, and repair work performed by qualified people.

If an operator does not strictly observe all safety rules and take precautionary actions, plasma cutting products and processes can cause serious injury or death, or damage to other equipment or property.

Safe practices have developed from past experience in the use of welding and cutting. These practices must be learned through study and training before using this equipment. Some of these practices apply

to equipment connected to power lines; other practices apply to engine driven equipment.

Anyone not having extensive training in welding and cutting practices should not attempt to use these machines.

Safe practices are outlined in the European Standard EN60974-1 entitled: Safety in welding and allied processes.

WARNING!

Only use safety equipment that has been approved by an appropriate standards agency. Unapproved safety equipment may not provide adequate protection. Eye and breathing protection must be AS/NZS compliant for the specific hazards in the work area.

DANGER!

Always wear AS/NZS compliant safety glasses and full face shield fitted with appropriate filter shade number. (Refer Filter Table above)

CAUTION!

Heavy-duty work gloves, non-skid safety shoes and hearing protection used for appropriate conditions will reduce personal injuries.

CAUTION!

Have the equipment serviced by a qualified repair person using identical replacement parts. This will ensure that the safety of the power tool is maintained.

Personal Safety

CAUTION!

Keep the work area well lit. Make sure there is adequate space surrounding the work area. Always keep the work area free of obstructions, grease, oil, trash, and other debris. Do not use equipment in areas near flammable chemicals, dust, and vapours. Do not use this product in a damp or wet location.

1. Stay alert, watch what you are doing and use common sense when operating equipment. Do not use a tool while you are tired or under the influence of drugs, alcohol or medication. A moment of distraction when operating equipment may result in serious personal injury.

2. Do not overreach. Keep proper footing and balance at all times. This enables better control of the plasma cutter in unexpected situations.

Arc Rays can Burn Eyes and Skin

DANGER!

Arc rays from the welding process produce intense heat and strong ultraviolet rays that can burn eyes and skin.

1. Use a Welding Helmet or Welding Face Shield fitted with a proper shade filter (refer AS 60974-1, AS/NZS 1337.1 and AS/NZS 1338.1 Safety Standards) to protect your face and eyes when plasma cutting or watching. (See Filter Table on pg 18)
2. Wear approved safety glasses. Side shields are recommended.
3. Use protective screens or barriers to protect others from flash and glare; warn others not to watch the arc.
4. Wear protective clothing made from durable, flame-resistant material (wool and leather) and foot safety protection.
5. Never wear contact lenses while plasma cutting.

Noise Can Damage Hearing

CAUTION!

Noise from some processes can damage hearing. Use AS/NZS compliant ear plugs or ear muffs if the noise level is high.

Work Environment Safety

DANGER!

Remove any combustible material from the work area.

1. When possible, move the work to a location well away from combustible materials. If relocation is not possible, protect the combustibles with a cover made of fire resistant material.
2. Remove or make safe all combustible materials for a radius of 10 metres around the work area. Use a fire resistant material to cover or block all doorways, windows, cracks, and other openings.

Recommended Protective Filters for Electric Welding		
Description of Process	Approximate Range of Welding Current in Amps	Minimum Shade Number of Filter(s)
Manual Metal Arc Welding - Covered Electrodes (MMA)	Less than or equal to 100	8
	100 to 200	10
	200 to 300	11
	300 to 400	12
	Greater than 400	13
Gas Metal Arc Welding (GMAW) (MIG) other than Aluminium And Stainless Steel	Less than or equal to 150	10
	150 to 250	11
	250 to 300	12
	300 to 400	13
	Greater than 400	14
Gas Metal Arc Welding(GMAW) (MIG) Aluminium and Stainless Steel	Less than or equal to 250	12
	250 to 350	13
Gas Tungsten Arc Welding (GTAW) (TIG)	Less than or equal to 100	10
	100 to 200	11
	200 to 250	12
	250 to 350	13
	Greater than 350	14
Flux-Cored Arc Welding (FCAW) - with or without Shielding Gas	Less than or equal to 300	11
	300 to 400	12
	400 to 500	13
	Greater than 500	14
Air - Arc Gouging	Less than or equal to 400	12
Plasma - Arc Cutting	50 to 100	10
	100 to 400	12
	400 to 800	14
Plasma - Arc Spraying	—	15
Plasma - Arc Welding	Less than or equal to 20	8
	20 to 100	10
	100 to 400	12
	400 to 800	14
Submerged - Arc Welding	—	2 (5)
Resistance Welding	—	Safety Spectacles or Eye Shield

Refer to standard AS/NZS 1338.1 for comprehensive information regarding the above table.

- Enclose the work area with portable fire resistant screens. Protect combustible walls, ceilings, floors, etc., from sparks and heat with fire resistant covers.
- If working on a metal wall, ceiling, etc., prevent ignition of combustibles on the other side by moving the combustibles to a safe location. If relocation of combustibles is not possible, designate someone to serve as a fire watch, equipped with a fire extinguisher, during the plasma cutting process and well after it is completed.
- Do not weld or cut on materials having a combustible coating or combustible internal structure, as in walls or ceilings, without an approved method for eliminating the hazard.
- After plasma cutting, make a thorough examination for evidence of fire. Be aware that visible smoke or flame may not be present for some time after the fire has started. Do not weld or cut in atmospheres containing dangerously reactive or flammable gases, vapours, liquids, and dust. Provide adequate ventilation in work areas to prevent accumulation of flammable gases, vapours, and dust.
- Do not apply heat to a container that has held an unknown substance or a combustible material whose contents, when heated, can produce flammable or explosive vapours. Clean and purge containers before applying heat. Vent closed containers, including castings, before pre-heating, welding, or cutting.

Electricity Can Kill



DANGER!

Touching live electrical parts can cause fatal shocks or severe burns. The electrode & work circuit is electrically live whenever the output is on.

1. Do not touch live electrical parts.
2. Wear dry, hole-free insulating gloves and body protection.
3. Insulate yourself from the work and the ground using dry insulating mats or covers.
4. Disconnect input power before installing or servicing this equipment. Lock input power, disconnect switch open, or remove line fuses so power cannot be turned on accidentally.
5. Properly install and ground this equipment according to national, state, and local codes.
6. Turn off all equipment when not in use. Disconnect power to equipment if it will be left unattended or out of service.
7. Do not use worn, damaged, undersized, or poorly spliced cables.
8. Do not wrap cables around your body.
9. Connect work piece to a good electrical ground.
10. Use only well-maintained equipment. Repair or replace damaged parts as soon as practical.

Fumes And Gases



WARNING!

Plasma cutting produces fumes and gases. Breathing these fumes and gases can be hazardous to your health.

1. Keep your head out of the fumes. Do not breathe the fumes.
2. If inside, ventilate the area and/or use an exhaust at the arc to remove welding fumes and gases.
3. If ventilation is poor, use an approved air-supplied respirator.
4. Read the Safety Data Sheets (SDS) and the manufacturer's instruction for the metals, consumables, coatings, and cleaners.

5. Work in a confined space only if it is well ventilated, or while wearing an air-supplied respirator. Be sure the breathing air is safe.
6. Do not use plasma cutter in locations near degreasing, cleaning, or spraying operations. The heat can react with vapours to form highly toxic and irritating gases.

Fire & Explosive Risks



WARNING!

Sparks and spatter fly off when plasma cutting. The flying sparks, hot metal, workpiece, and hot equipment can cause fires and burns.

Accidental contact of electrode or welding wire to metal objects can cause sparks, overheating, or fire.

1. Protect yourself and others from flying sparks and hot metal.
2. Do not plasma cut where flying sparks can strike flammable material.
3. Remove all flammables within 10m of the plasma cutting site.
4. Be alert that plasma cutting sparks and hot materials can easily go through small cracks and openings to adjacent areas.
5. Watch for fire, and keep a fire extinguisher nearby.
6. Be aware that plasma cutting on a ceiling, floor, bulkhead, or partition can cause fire on the hidden side.
7. Do not plasma cut on closed containers such as tanks or drums.

Sparks & Hot Metal



WARNING!

Chipping and grinding causes flying metal, and as welds cool they can throw off slag.

1. Wear an AS/NZS approved face shield or safety goggles. Side shields are recommended.
2. Wear appropriate safety equipment to protect the skin and body.

Warranty

As part of an on-going commitment to excellence in product support, Euroquip offers a comprehensive product warranty program.

In order to qualify for full warranty support, your product must be registered.

Product not registered with Euroquip is supported by a base 12 month warranty only. Spare parts and technical support will not be available for an unregistered product outside of this base warranty period.

If a Euroquip dealer has not already registered your product, please register it online at www.euroquip.co.nz. Under 'Contact Us' link. To request a physical registration form, please contact Euroquip customer service on 0800 387 678.

Registered warranty period for the WT35P:
Commercial Use: 18 Month with registration
Domestic Use: 18 Month with registration

Warranty covers failure caused by manufacturing and material defects in the product, during the warranty period specified. The warranty period begins when the product is purchased by the end user. Warranty is not transferrable and is only claimable by the original purchaser.

Warranty does not cover parts that are subject to wear and tear from usage.

Warranty covers failure of a product caused by defective materials and/or manufacturing for the period given and the usage specified by Euroquip. The warranty period begins when the product is purchased by the end user. Warranty is not transferrable and is only claimable by the original purchaser.

Warranty also does not cover failure caused by the untimely replacement or service of the above wearing parts. Evidence must be provided that the product has been maintained and serviced suitably for a claim to be considered under warranty.

Failure caused by incorrect operation of the product, lack of proper care and maintenance of the product, external damage, external circumstances such as contaminated fuel or poor water supply, modifications to the product, attempted repair/ service by a

party other than an Approved Service Agent, is not covered under warranty.

Warranty does not cover pre delivery service and adjustment, or failure that may occur as a result of lack of/ incorrect pre delivery service and adjustment.

Warranty does not cover any incidental, indirect or consequential loss, damage or expense that may result from any defect, failure or malfunction of a product.

Should any issue be found to be a combination of a warranty failure and a non-warranty issue, the repair cost component to rectify and repair the non-warranty failure is the customers' full responsibility.

The decision that an issue with a product qualifies as a warranty claim is made at the sole jurisdiction of Euroquip.

No costs incurred will be considered under warranty if repairs are carried out by a party other than a Euroquip Approved Service Agent, unless with prior consent in writing from Euroquip.

It is the responsibility of the purchaser to deliver a product under warranty to the nearest relevant service agent or product reseller. Warranty does not cover call outs, mileage and freight costs.

If a product is repaired under warranty, parts and labour required for the repair will be supplied at no charge. Warranty assessment and repair will be scheduled and executed according to the normal work flow at the service location and depending on the availability of suitable replacement parts.

This warranty policy is an additional benefit and does not affect the legal rights of any end user, reseller or service agent.



Scan here to register your product



Congratulations on your new WELDTECH product. We are proud to have you as our customer and will strive to provide you with the best service and reliability in the industry. This product is backed by our extensive warranty and service network. To locate your nearest distributor or service agency visit www.weldtech.net.nz, or email us at customerservice@euroquip.co.nz

www.weldtech.net.nz