

WAGNER

**FURNO HEAT GUN
F750 ELECTRONIC LCD
HOT AIR MULTI PURPOSE TOOL
OWNER'S MANUAL**

Model: 2363345

GB **AUS**

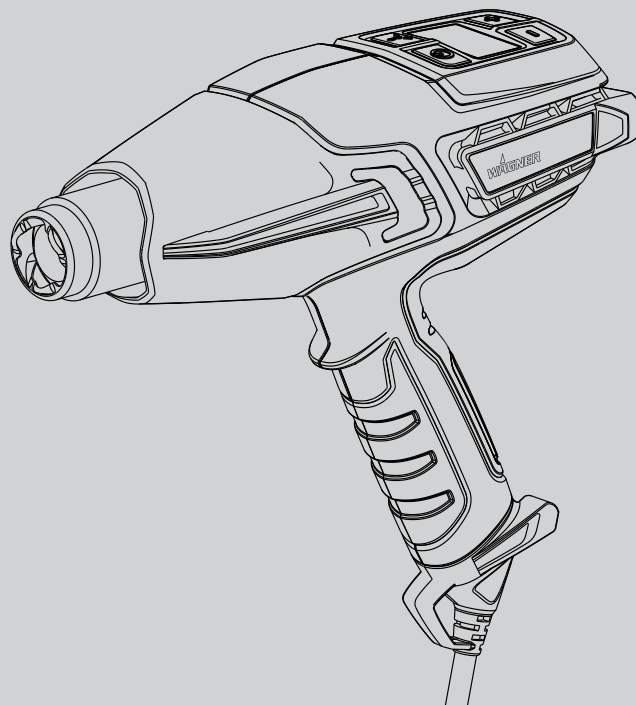



**Important Safety Information • Read all safety information before operating the equipment.
Save these instructions**

To reduce the risks of fire or explosion, electrical shock and the injury to persons, read and understand all instructions included in this manual. Be familiar with the controls and proper usage of the equipment.

! Indicates a hazardous situation which, if not avoided, could result in death or serious injury.

HAZARD: POISON

Extreme care should be taken when stripping paint. The peelings, residue and vapours of paint may contain lead, which is poisonous. Any paint applied to homes before 1950 is likely to contain lead. Any paint manufactured before 1977 may contain lead. Once the paint is deposited on surfaces, hand-to-mouth contact can result in the ingestion of lead. Exposure to even low levels of lead can cause irreversible brain and nervous system damage. Young and unborn children are particularly vulnerable to lead poisoning.

Before beginning any paint removal process you should determine whether the paint you are removing contains lead. This can be done by your local health department or by a professional who uses a paint analyser to check the lead content of the paint to be removed. Lead-based paint should only be removed by a professional and should not be removed using a Heat Gun.

PREVENTION:

Move the work piece outdoors, sheltered from rain. If this is not possible, keep the work area well-ventilated. Open the windows and put an exhaust fan in one of them. Be sure the fan is moving the air from inside to outside.

- Remove or cover any carpets, rugs, furniture, clothing, cooking utensils and air ducts.

- Place drop cloths in the work area to catch any paint chips or peelings. Wear protective clothing such as extra work shirts, overalls and hats.
- Work in one room at a time. Furnishings should be removed or placed in the centre of the room and covered. Work areas should be sealed off from the rest of the dwelling by sealing doorways with drop cloths.
- Children, pregnant or potentially pregnant women and nursing mothers should not be present in the work area until the work is done and all cleanup is complete.
- Wear an approved dust respirator mask or a dual filter respirator mask for dust and fumes. These masks and replaceable filters are readily available at major hardware stores. Be sure that the mask fits properly. Beards and facial hair may keep masks from sealing properly. Change the filters often. Disposable paper masks are not adequate.
- Use caution when operating the Heat Gun. Keep the Heat Gun moving as excessive heat will generate fumes which can be inhaled by the operator.
- Keep food and drink out of the work area. Wash hands, arms and face and rinse mouth before eating or drinking. Do not smoke or chew gum or tobacco in the work area.
- Clean up all removed paint and dust by wet mopping the floors. Use a wet cloth to clean all walls, sills and any other surface where paint dust is clinging. Do not sweep, dry dust or vacuum. Use a high phosphate detergent of trisodium phosphate (TSP) to wash and mop areas.
- At the end of each work session, put the paint chips and debris in a double plastic bag, close it with tape or twist ties and dispose of properly.
- Remove protective clothing and work shoes in the work area to avoid carrying dust into the rest of the building. Wash work clothes separately. Wipe shoes off with a wet rag and then wash it with the work clothes. Wash hair and body thoroughly with soap and water.

HAZARD: EXPLOSION OR FIRE

This Heat Gun produces extremely high temperatures (as high as 630°C). It must be used with caution to prevent combustible material from igniting.

PREVENTION:

- Keep the Heat Gun in constant motion. Do not stop or dwell in one spot.
- Use extreme caution if the other side of the material being scraped is inaccessible, such as house siding. The hidden side could catch on fire if it becomes too hot. Some buildings contain highly flammable materials behind siding walls, floors, fascia, soffit boards and other panels. Check these areas before applying heat and do not use a heat tool if flammable materials are present or if you are unsure of the hidden material.
- Do not use near surfaces with cracks or near metal pipes or flashing. Heat may be conducted behind the work surface and ignite hidden material. The ignition of hidden materials may not be readily apparent and can result in property damage and injury.
- Do not use electric tools in the presence of flammable liquids or gases.
- Do not use near combustible materials such as dry grass, leaves, and paper which can scorch and catch fire.
- The nozzle becomes very hot. Do not lay the Heat Gun on flammable surfaces when operating the gun or immediately after switching the gun off. Always set the gun on a flat, level surface so that the nozzle tip is directed upwards and away from the supporting surface.
- Do not touch the nozzle until the tool has cooled.
- Do not use the Heat Gun as a hair dryer.
- Tools and paint scrapings become very hot. To avoid burns, use work gloves and eye protection when scraping.

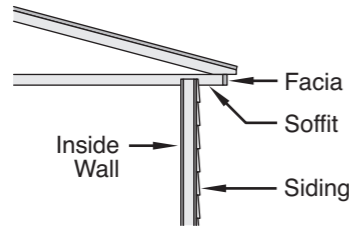

- Always treat the Heat Gun with the same respect as an open flame.
- Do not use in presence of an explosive atmosphere.

HAZARD: ELECTRIC

May cause property damage, severe injury or loss of life.

PREVENTION:

- Do not disassemble the Heat Gun.
- Do not work in wet areas or expose the Heat Gun to rain or moisture.
- Guard against electric shock by preventing body contact with grounded surfaces such as pipes, radiators, ranges, aluminium ladders or other grounded devices.
- Do not abuse the cordset. Never carry the Heat Gun by the cordset or yank on the cordset to disconnect it from the power supply. Keep the cordset away from heat, oil and sharp edges. Inspect the cordset for wear or damage regularly.
- If an extension cord is damaged or otherwise unsuitable for use, replace it with a new extension cord.

HAZARD: GENERAL

May cause property damage or severe injury.

PREVENTION:

- Always disconnect the Heat Gun from the power supply when not in use. Store indoors in a dry place and out of the reach of unsupervised children.
- Keep your work area well lit and clean.
- Do not overreach, especially when working on ladders. Keep proper footing and balance at all times. Be certain any ladders being used are sturdy, stable, on firm ground and erected at safe working angles.
- Avoid power lines.
- Keep moveable items secured and steady while scraping.
- Always use protective eyewear when working.
- Stay alert and use common sense when operating any tool.
- Never use to thaw frozen pipes located inside walls or near combustibles. Always use reflector nozzle (P/N2366225) to thaw frozen pipes.

- Do not leave the heat gun unattended while it is switched on.
- This appliance can be used by children aged from 8 years and above and persons with reduced physical, sensory or mental capabilities or lack of experience and knowledge if they have been given supervision or instruction concerning use of the appliance in a safe way and understand the hazards involved. Children shall not play with the appliance.
- Keep the appliance and its cord out of reach of children aged less than 8 years.

MAINS CONNECTION (UK only)

This Heat Gun has been supplied with a fused cordset. This is identified by the fuse holder in the base of the plug. Please read the following safety instructions before use:

1. If the cordset is damaged replace with a new cordset to avoid a safety hazard. Please contact Wagner customer services for a replacement cordset.
2. **NEVER** under any circumstances use the Heat Gun or cordset without the fuse cover fitted. This is the little cover fixed into the base of plug to hold the fuse in place.
3. If you lose the fuse cover then please contact any electrical dealer for a replacement or ring our helpline.
4. A replacement fuse must be rated at 13 Amps. This must be manufactured and approved to BS1362.
5. **IF IN ANY DOUBT PLEASE CONSULT A QUALIFIED ELECTRICIAN.**

MAINS CONNECTION (Non-UK)

This Heat Gun has been supplied with a cordset. If the cordset is damaged replace with a new cordset to avoid a safety hazard. Please contact Wagner customer services for a replacement cordset.

IF IN ANY DOUBT PLEASE CONSULT A QUALIFIED ELECTRICIAN.

WARNING - Use an extension cord that will accept the plug on the product. Make sure your extension cord is in good condition. When using an extension cord, be sure to use one heavy enough to carry the current your product will draw. An undersized cord will cause a drop in line voltage resulting in loss of power and overheating. A

harmonised H05RR-F 3 x 1.0sq mm rubber type cord is required as a minimum for general use.

Using the Heat Gun**General Description**

This Heat Gun is a quality power tool. Like any power tool, it can be dangerous when misused. Read the following instructions carefully and follow all safety precautions. It is the responsibility of the owner to use the Heat Gun properly.

Specifications

Housing	Engineered high-impact corrosion and heat-resistant polymers
Wattage	2000 Watts on HIGH, 150 Watts on LOW
Voltage	220 - 240 V a.c.
Frequency	50 - 60Hz
Heat Output	Approximately 630 °C on HIGH, approximately 60 °C on LOW
Weight	0.9 kg

Features Fig. 1

- 1) Control panel - temperature and fan speed
- 2) Hanging hook
- 3) Cordset with integrated stabilizers (removable with tool)
- 4) Rear stabilizer fins (upright standing)
- 5) Side bars to prevent nozzle touching surface
- 6) Nozzle Heat Shield

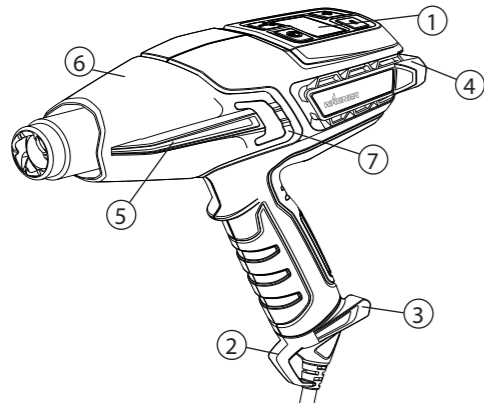
Fig. 1**Removing the barrel cover**

The barrel cover can be removed when working in hard to reach locations. **BE CAREFUL OF THE NOZZLE.** Increased risk of burning exists when working without the barrel cover. To remove the barrel cover, use a small flat head screw driver to lift tab (Fig. 1, 7) over raised area.

Attaching the cordset

The cordset (Fig. 2, 1) for the Heat Gun is delivered detached from the gun (Fig. 2, 2). To attach, line up the cord with the socket on the handle of the gun and press firmly together until you hear a click. The cord set does not need to be removed. If required to detach, insert a small screwdriver or similar tool (Fig. 2, 3) into the hole as shown (Fig. 2, 4). Once resistance is felt on the end of the tool, apply pressure to depress the release mechanism. Firmly pull the cordset away from the gun.

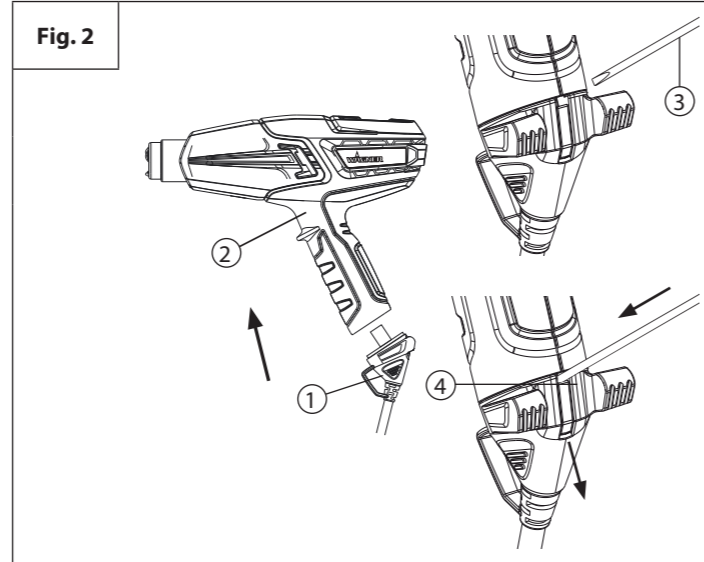
Fig. 2**Touch Pad Control Panel**

The heat gun gives you a wide temperature range to choose from, depending upon the type of project. These can be controlled via the Control Panel.

Temperature Guide LCD Display (Fig. 3)**Description Fig. 3**

- | | |
|--|---|
| 1) Power button: Turns the heat gun ON and OFF or switches the heat tool into cool down mode | 2) Mode selector: Sets the temperature range and air flow speed you are using |
| 3) Air flow icon | 4) Air flow indicator. Fills from right to left |
| 5) Text/number display | 6) Temperature icon |
| 7) Temperature indicator. Fills from left to right | 8) Temperature selector: Increase the temperature (+) |
| 9) Temperature selector: Decrease the temperature (-) | |

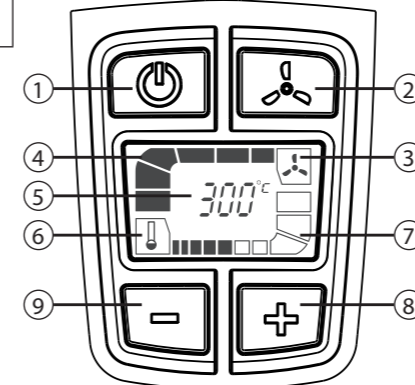
Fig. 3

Screen currently shows default start-up display. 300°C at highest fan speed.

Cool Down Mode (Fig. 4)

While the heat gun is operating, press the power button once to enter cool down mode. When cool down mode is entered, the gun will run for 30 seconds with maximum air flow. During this period, the temperature bars will all flash and step down to indicate cooling. To override cool down mode, press and hold the power button for 2-3s.

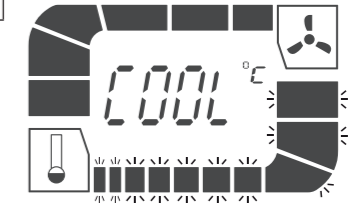
Fig. 4

Following Cool down mode the barrel of the gun will still be hot.

Start Up

! Always read the safety information included in this manual before using the Heat Gun.

1. Plug the Heat Gun into a standard socket-outlet.
2. Turn on the heat gun by pressing the power button on the Control Panel (Fig. 3, 1). When the gun is turned on, it is automatically set to the default temperature of 300°C as shown in Fig. 3.
3. Use the plus and minus buttons (Fig. 3, #8 & #9) to adjust the temperature. Single press to increase temperature in ten degree increments.
4. As the temperature is increased, bars will flash to indicate that the gun is coming up to temperature. As the higher temperature is reached, the bars turn solid.
5. As the temperature is decreased, bars will flash to indicate that the gun is still at a high temperature. As the lower temperature is reached, the bars turn off.

IMPORTANT: If the blower motor in the heat gun does not turn on when the POWER button is activated, turn the switch OFF immediately. The heating element will burn out if it is not cooled by the blower.

6. During rest periods or when you are finished with your project, press the power button to enter cool down mode.
7. Set the gun down in an upright position. The heat gun will shut itself off after 30 seconds.
8. To override cool down mode press and hold the power button for 2 to 3 seconds. The gun will power off immediately.

Note: Smoke may appear during the first start up due to the burning of manufacturing oils. The smoke should disperse shortly after first start up.

Hands-free operation Fig. 5

The Heat Gun has an integrated stand (Fig. 1, 4) for bench top applications and for cooling down. Alternatively the heat gun carry case (Fig. 6) has been specifically designed to locate the heat gun in the upright position for work on uneven surfaces.

Fig. 5

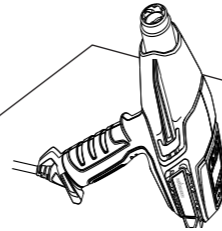

AngleLoc carry case

The heat gun carry case with AngleLoc has been specifically designed to locate the heat gun in the upright position for work on uneven surfaces.

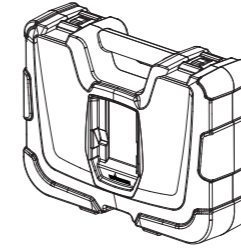

AngleLoc mount Fig. 6a & 6b

- a: Insert the back of the heat gun so that the rear stabilizing fins locate themselves below the ridges on the side wall of the cavity in the top of the carry case.
- b: Then slide the heat gun forward so that it naturally locks into place at a 135 degree angle. The heat gun should now be secure for upright use.

Fig. 6a

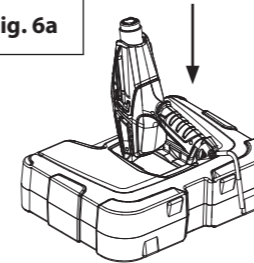
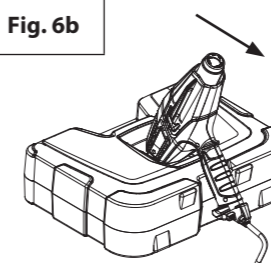

Fig. 6b



IMPORTANT: If the motor-driven fan in the Heat Gun does not turn on when the switch is set to either LOW or HIGH, turn the switch OFF immediately. The heating element will burn out if it is not cooled by the motor-driven fan.

Note: Always set the Heat Gun upright after it is turned off, either for a short break or for storage. Avoid laying the unit on the side after shutdown. The heat will remain in the unit and cooling will take longer. Store the unit only after the nozzle is cool. Unplug the unit before storing to prevent accidental start-up.

IMPORTANT: Always protect glass when working near windows.

! Do not touch nozzle or any other tool being used when working. These become extremely hot and will cause severe burns. Wear gloves to protect hands from hot scrapings.

Many variables affect heating applications, such as the material being heated, ambient temperature, the distance from the gun to the substrate and the heating technique. For this reason Wagner has provided temperature guidelines for certain applications. Always start the heat gun at the lowest temperature in the range then raise the temperature until the optimum temperature is achieved. Always keep the heat gun in motion and at least 5cm from the substrate when applying heat.

The FURNO 750 Heat Gun is one of the most versatile tools you can own. It can be used for a great variety of projects, from big DIY to small Art & Crafts jobs. For more details on multiple projects and 'how to' videos please visit our website www.wagner-group.com.

Use	Heat	Nozzle Tip Options
DIY	Stripping paint	HIGH Concentrator or Wide
	Wall repair	LOW Open (no tip)
	Drying paint	LOW Open (no tip)
	Soften adhesives to remove floor tiles	LOW Wide concentrator
	Bend plastic, plexiglass, formica	LOW/HIGH Reflector Nozzle
	Removing formica and linoleum	LOW Wide concentrator
	Soften paint, caulking and putty for easier removal	HIGH Concentrator or Wide concentrator
	Removing varnish	LOW-MED Wide concentrator
	Shrink plastic film for wrapping or weatherproofing	LOW Wide concentrator
Small jobs (including repair)	Loosen rusted nuts, bolts and fittings	HIGH Open/ Concentrator
	Repairing jeans	LOW Wide concentrator
	Burning weeds	HIGH Concentrator
	Removing adhesives	LOW Open (no tip)
	Waxing skis/snowboard	LOW Wide concentrator
	Glass fibre work	HIGH Concentrator or Wide

Use	Heat	Nozzle Tip Options
	Unfreezing pipes and locks	LOW Reflector Nozzle
	Lighting a bbq grill	HIGH Concentrator / BBQ Nozzle
	Heat shrink tubing/ connectors	LOW-MED Reflector Nozzle
	Heat concrete prior to patching	LOW/HIGH Concentrator
	Defrosting refrigerator / freezer	LOW Open (no tip)
	Art & Crafts	Making candles
Making soap		LOW Open (no tip)
Shrink wrapping presents		LOW Open (no tip)
Forming foam		LOW Open (no tip)
Cookie decoration		LOW/HIGH Open (no tip)
Automotive	Removing stickers, emblems and decals	LOW Open (no tip)
	Removing dents	HIGH Open (no tip)
	Removing paint	HIGH Concentrator or Wide
	Applying and removing window tint	LOW Open (no tip)
	Restoring bumpers	HIGH Open (no tip)
Electronics	Smartphone & tablet repair	LOW Concentrator
	PlayStation and Xbox repair	LOW Concentrator

Stripping Paint

The Heat Gun heats up the surface and causes the paint to soften, at which time it can be scraped off easily without damaging the surface. Some paints may soften even though they do not blister; some may become rubbery, and some may require higher heat.

When working with several layers of paint, it speeds up the scraping process to heat the surface thoroughly, all the way to the wood., then all the layers can be scraped at one time.

A soft wire brush may be the best tool to use for very intricate surfaces. Mineral paints and finishes, such as cement paint and porcelain, do not soften with heat, so using a heating tool will not work for paint removal.

The best method of paint removal

Move the Heat Gun slowly and steadily forward at an angle to the surface, pointing the nozzle in the direction of motion. This allows you to scrape safely outside the hot air stream and keeps the scraper and the scraped surface cooler.

- Warm air preheats the surface.
- Paint is softened by hot air.
- Deep penetration of heat over total area.
- Paint can be easily scraped off as soon as it is softened and the gun is moved forward.
- Stripped surface allowed to cool.

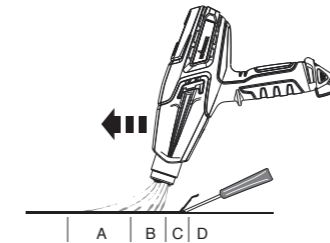

IMPORTANT: The removal of paint by a Heat Gun is safe if the above guidelines are used, but always keep either a container of water or an ABC fire extinguisher (suitable against Class A, B and C type fires) within reach.

Note: Do not use the Heat Gun on surfaces that can be damaged by heat, such as vinyl-coated panelling, vinyl-coated siding or vinyl-coated window frames.

When removing paint from window frames, the Heat Gun will soften the putty. Be careful not to gouge the putty with the scraper. The putty will firm up after it cools.

Do not use the Heat Gun on insulating laminated window glass such as Thermopane. The glass edge expansion may break the edge seal.

When scraping fascia, do not overheat the edges of the asphalt shingles protruding over the edge of the sheathing. Too much heat will melt the asphalt.

Cleaning and Maintenance

Keep the intake openings on the housing clean and free of obstructions. Use a soft, dry brush to clean the openings periodically. Use only mild soap and a damp cloth to clean the Heat Gun. Many household cleaners contain chemicals which could seriously damage the housing.

Do not use petroleum, turpentine, lacquer or paint thinner, dry cleaning fluids or similar products when cleaning the Heat Gun.

NEVER allow any liquid to get inside the tool or immerse any part of the tool into a liquid.

Cleaning and user maintenance shall not be made by children unless they are older than 8 years and supervised.



Storage



Allow the Heat Gun nozzle to cool to room temperature before placing in storage.

The nozzle will turn dark over time because of the high heat. This is normal and will not affect the performance or life of the unit.

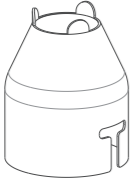
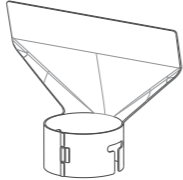
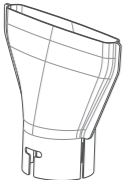
Accessories

The following accessories may come with the Heat Gun or may be purchased separately by visiting www.wagner-group.com/service. Alternatively see back of manual for your nearest Service Centre.

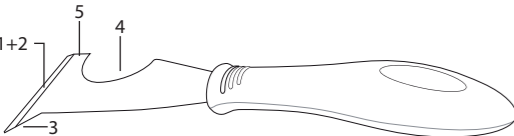
Name	Description	Name	Description
Concentrator Nozzle P/N2366222	 Directs a concentrated heat flow to the work surface. Ideal for removing paint in awkward corners, crevices, mouldings, beading or architraves.	Glass Protection Nozzle P/N2366224	 Deflects the heat away from glass or other fragile areas. Ideal for window sills, ledges, frames and skirting boards.
Wide Concentrator Nozzle P/N2366223	 Directs a long, narrow heat pattern to the work surface. Ideal for removing paint or varnish from large, flat surfaces such as skirting boards, doors, stairs, etc. It should be used in conjunction with a flat scraper.	Reflector Nozzle P/N2366225	 Disperses the heat flow evenly around the whole work surface. Ideal for thawing frozen pipes, solder pipe work, bending plastics or heat shrinking electrical insulating tubing.

Name	Description
 5-in-1 Detailed Scraper Tool P/N2366227	This tool has 5 functions. The blade is used to (1) scrape paint and (2) spread compound. The gouge point (3) is used to remove putty/caulk from open cracks. The curved area (4) is used to clean roller covers. The flat side (5) can be used to open paint tins.
 Carry Case P/N2366226	The heat gun carry case with AngleLoc has been specifically designed to locate the heat gun in the upright position for work on uneven surfaces.

Product Registration

Register your product online at www.wagner-group.com/3plus1 to qualify for your additional 1 year guarantee.

3+1 years guarantee

The guarantee runs for three years, counting from the date of sale (sales slip). The guarantee is extended by a further 12 months if the device is registered online within 4 weeks of the purchase at www.wagner-group.com/3plus1. Registration is only possible if the buyer is in agreement with the data being stored that is entered during registration. The guarantee covers and is restricted to free-of-charge rectification of faults which are demonstrably attributable to the use of faulty materials in manufacture, or assembly errors; or free-of-charge replacement of the defective parts. The guarantee does not cover incorrect use or commissioning or fitting or repair work which is not stated in our operating instructions. Wearing parts are also excluded from the guarantee. The guarantee excludes commercial use. We expressly reserve the right to fulfil the guarantee. The guarantee expires if the tool is opened up by persons other than wagner service personnel. Transport damage, maintenance work and loss and damage due to faulty maintenance work are not covered by the guarantee. Under any guarantee claim, there must be proof of purchase of the tool through submission of the original receipt. Wherever legally possible, we exclude all liability for injury, damage or consequential loss, especially if the tool has been used for a purpose other than that stated in the operating instructions, commissioned or repaired other than in accordance with our operating instructions or if repairs are performed by someone who is unqualified. We reserve the right to perform any repairs in excess of those stated in our operating instructions. In case of guarantee or repair, please refer to your point of sale. This guarantee does not affect your statutory rights.

INFORMATION ON THE DISPOSAL OF WASTE ELECTRICAL AND ELECTRONIC EQUIPMENT KNOWN AS WEEE



Your attention is brought to new directives applicable to the disposal of this electrical equipment where, in accordance with legislation, this product must not be disposed of in your normal household waste. Instead it is your responsibility to dispose of this type of waste by handing it over to special designated collection points for recovery and recycling. This product is marked with a 'Wheelie bin' symbol with a cross on it to remind you of this action. The objective of this directive is to help conserve resources and ensure that it is recycled in a manner that protects human health and the environment. For more information about where you can drop off your waste please contact your local authority, take back facilities are free of charge.

CE Declaration of Conformity

This product complies with the Low Voltage Directive 2014/35/EU, EMC Directive 2014/30/EU, RoHS Directive 2011/65/EU and REACH Regulation 1907/2006.

FURNO 750

FURNO 750

DE J. WAGNER GMBH
Otto-Lilienthal-Str. 18
D-88677 Markdorf
T +49 0180 - 55 92 46 37
F +49 075 44 - 05 11 69

FR WAGNER FRANCE S.A.R.L.
12 Avenue des Tropiques
Z.A. de Courtaboeuf
F-91978 Les Ulis Cedex
T +33 0825 011 111
F +33 (0) 1 69 81 72 57

DK ORKLA HOUSE CARE DANMARK A/S
Stationsvej 13
3550 Slangerup
DK-Danmark
T +45 47 33 74 00
F +45 47 33 74 01

SE ORKLA HOUSE CARE AB
Box 133
564 23 Bankeryd
SV-Sweden
T +46(0)36 37 63 00

SK E-CORECO SK S.R.O.
Kráľovská ulica 8/7133
SK-927 01 Šaľa
T +42 1948882850
F +42 1313700077

GB WAGNER SPRAYTECH (UK) LTD
Opus Park
Moorfield Road
Guildford, Surrey, GU1 15Z
T +44 (0) 1483 454666
F +44 (0) 1483 454548

NO ORKLA HOUSE CARE NORGE AS
Nedre Skøyen vei 26,
PO Box 423, Skøyen
N-0213 Oslo
T +47 22 54 40 19

RO ROMIB S.R.L.
str. Poligonului nr. 5 - 7
ROM-100070 Ploiesti, judet Prahova
T +40-344801240
F +40-344801239

CZ E-CORECO S.R.O.
Na Roudné 102
CZ-301 00 Plzeň
T +42 734 792 823
F +42 227 077 364

HU HONDIMPEX KFT.
Kossuth L. u. 48-50
H-8060 Mór
T +36 (-22) - 407 321
F +36 (-22) - 407 852

PL PUT WAGNER SERVICE
ul. E. Imieli 27
PL-41-605 Swietochlowice
T +48 32 - 346 37 10
F +48 32 - 346 37 13

CH J. WAGNER AG
Industriestraße 22
CH-9450 Altstätten
T +41 71 - 7 57 22 11
F +41 71 - 7 57 23 23

AU WAGNER SPRAYTECH AUSTRALIA PTY. LTD.,
14-16 Kevlar Close
AUS-Braeside, VIC 3195
T +61 3 95 87 - 20 00
F +61 3 95 80 - 91 20

ES MAKIMPORT HERRAMIENTAS, S.L.
C/ Méjico nº 6
Pol. El Descubrimiento
E-28806 Alcalá de Henares
(Madrid)
T 902 199 021 / 91 879 72 00
F 91 883 19 59

PT

Irrtümer und Änderungen vorbehalten.
Not responsible for errors and changes.
Sous réserves d'erreurs et de modifications.
Fouten en wijzigingen voorbehouden.

Material No. 2366232
06/2016
© Copyright by J.Wagner GmbH