

2 Pickup, 3 Volume, 1 Tone, 3 Way Switch

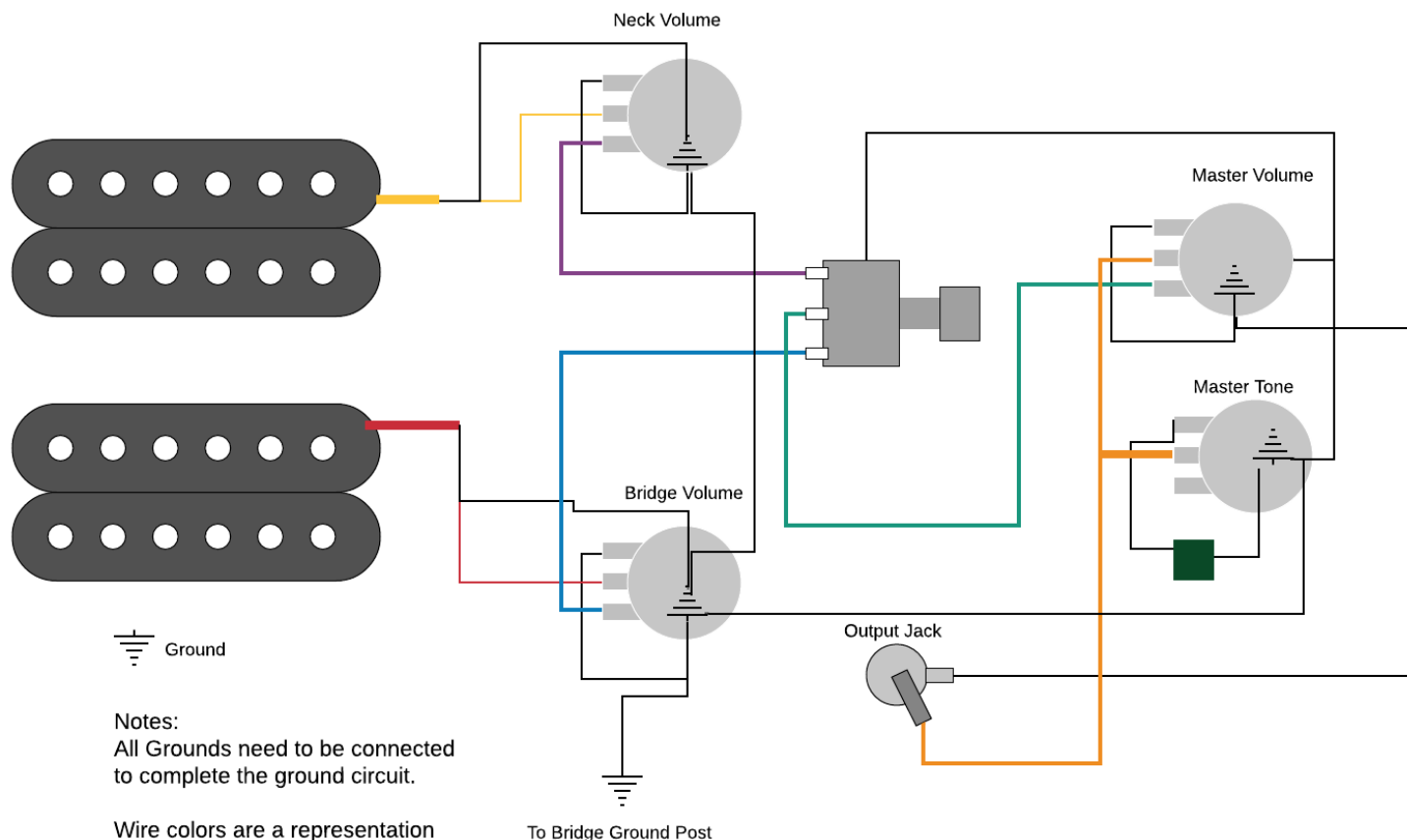

Ground

Notes:

All Grounds need to be connected to complete the ground circuit.

Wire colors are a representation only, actual colors may vary between kits.