

User Manual

12.8V 100Ah

Lithium Iron Phosphate
(LiFePO₄) Battery



CONTENTS

Packages Contents	01
Important Safeguards	01
Warnings	01
Before Using	02
Specifications	03
Getting To Know Your Battery	06
Before First Use	07
Check the State of the Charge	07
How to Test Battery Using a Multimeter	08
Using Your Battery	09
Connection	09
Installation	13
Inverter Setting	15
Recommended Cable Sizing	16
How to Charge Your Batteries	16
Troubleshooting	19
Warranty Information	20



PACKAGES CONTENTS



LiFePO4
Battery 12.8V 100Ah



User Manual



Insulating Caps



Terminal Bolts



IMPORTANT SAFEGUARDS

WARNINGS

BATTERY DISPOSAL

To prevent any risks of fire and/or explosion, please wrap the electrode in insulating paper before disposal.

PROHIBITION OF DISASSEMBLY

Do not disassemble the battery. Unguided Disassemble may cause an internal short circuit and lead to potential risks such as gassing, fire hazards, and explosions.

ELECTROLYTE IS HARMFUL

Li-Fe battery should not have liquid from electrolytes under normal use. However, in case of any physical contact with any liquid that comes out of it, please immediately rinse with a lot of clean water and seek medical advice if necessary.

PROHIBITION OF WATER CONTACT

Keep the battery away from water and/or any liquid.

PROHIBITION OF USE WHEN UNIT OR PARTS ARE DAMAGED

Do not use the unit when the unit/parts are damaged in any way. Do not use it when emitting smells of electrolyte, leaking, and/or any other abnormalities appear. When the electrolyte emits smells and/or leaks, please immediately place the battery away from the heat source to prevent any potential risks of fire hazards and explosions.

PROHIBITION OF USING IN BELOW PLACES

Do not use the battery in or near places with strong static electricity and/or strong magnetic to prevent any potential damage to the battery.

CAUTION: RISKS OF FIRE, EXPLOSION OR BURNS

DO NOT Short-circuit

DO NOT Reverse connections from the charger to the battery

DO NOT Disassemble

DO NOT Throw into fire or incinerate

DO NOT Heat above 70°C / 158°F

| BEFORE USING

- Always put on the insulating covers on the post bolts to avoid metal or conductive objects touching the positive and negative terminals of the battery at the same time, otherwise, it is likely to cause a short circuit.
- Always install the battery upright with the post bolt facing up, and it should NOT be mounted upside down. If needed to mount the battery at its side please contact the service support-online@siekonenergy.com to confirm the direction.
- Always tightly screw in the post bolts. Having loose battery terminals will cause the terminals to build up heat resulting in damage to the battery.
- This battery is not intended to be used to start any devices, please **DO NOT** use it as a starting battery.

- **Suggestions for Long-term Storage:**

- ▶ **Temperature**

- The battery can be operated at a temperature of -20°C to 55°C / -4°F to 131°F and a temperature between -20°C to 45°C / -4°F to 113°F is ideal for long-term storage. Store in a fireproof container and away from children.

- ▶ **Capacity**

- For a longer-lasting product, it is best to store your battery at a 50% charge level and recharge every three months if it is not going to be used for a long time.

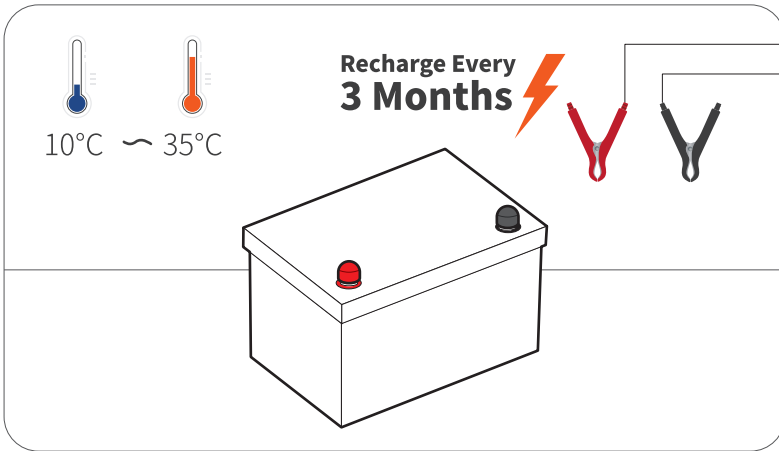

SPECIFICATIONS

Battery type-Chemistry	LiFePO4
Nominal Voltage	12.8V
Nominal Capacity	100Ah
Nominal Energy	1280Wh
Recommended Charge Current	20A

Voltage Window	10.8-14.4V
Recommended Charge Voltage	14V
Max Charge Voltage	14.6V
Max Continuous Current	100A
Recommended Discharge Voltage	11.2V
Max Discharging Voltage	10.8V
Max Continuous Discharge Current	100A
Peak Discharge Current	200A/3S

Case Material	ABS
Dimensions(LxWxH)	330*171*220mm 12.99*6.73*8.66inch
Weight	10.5KGS
Terminal Type	T16
Terminal Torque	8.5NM

BMS Build-in	Yes
Cycle Life (0.2C, 25°C@80% DOD)	6000 Cycles
AH Efficiency Round Trip	>98%

Discharge Temperature	(- 20 to 55)°C
Self Discharge per Month	<3%
Charge Temperature	(0 to 55)°C
Storage Temperature	(- 20 to 45)°C
Max in Parallel	4Pcs
Max in Series	4Pcs



GETTING TO KNOW YOUR BATTERY

12.8V 100AH BATTERY

Operating Voltage: 12.8V

Max Continuous Load Power: 1280W

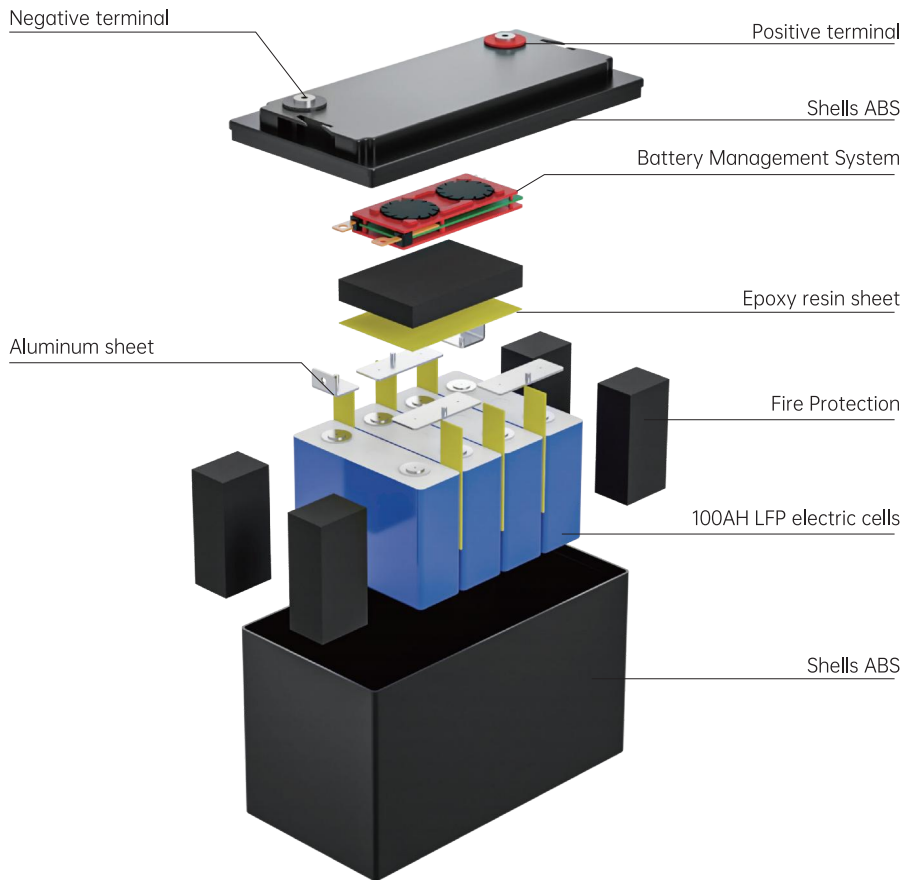



BEFORE FIRST USE

CHECK THE STATE OF THE CHARGE

1 Test the Battery Voltage with a Multimeter

Refer to page 8 for 'How to test battery using a 'Multimeter' If the voltage tested is below 12V, please contact us at support-online@siekonenergy.com to help solve the problem.

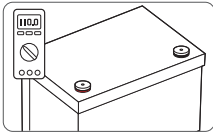

2 Pull Out Insulating Caps and Tightly Screw in Post Bolts

Please pull out the insulating caps and tightly screw in the post bolts. Having loose battery terminals will cause the terminals to build up heat resulting in damage to the battery.

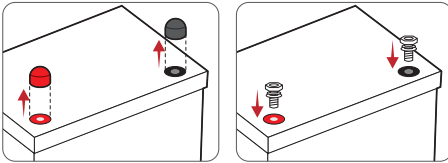

3 Fully Charge the Battery

Refer to page 16~18 for charging methods.

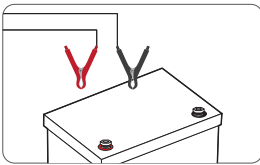

4 Connect to Use

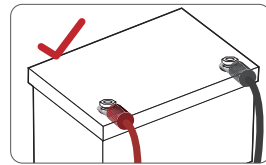

5 Put On Insulating Covers

Please put on the insulating covers to avoid metal or conductive objects touching the positive and negative terminals of the battery at the same time, otherwise, it is likely to cause a short circuit.

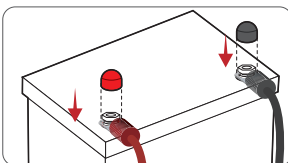



HOW TO TEST BATTERY USING A MULTIMETER

Based on the characteristics of Lithium Iron Phosphate (LiFePO₄) batteries, the voltage measured by all LiFePO₄ batteries **during charging/discharging is not the real voltage of the battery.**

Therefore, after charging/discharging and disconnecting the battery from the power source, the voltage of the battery will gradually drop/increase to its real voltage.

If you need to test the real voltage of the battery, please disconnect all the connections to the battery and test its voltage after putting it aside for over 30 minutes.

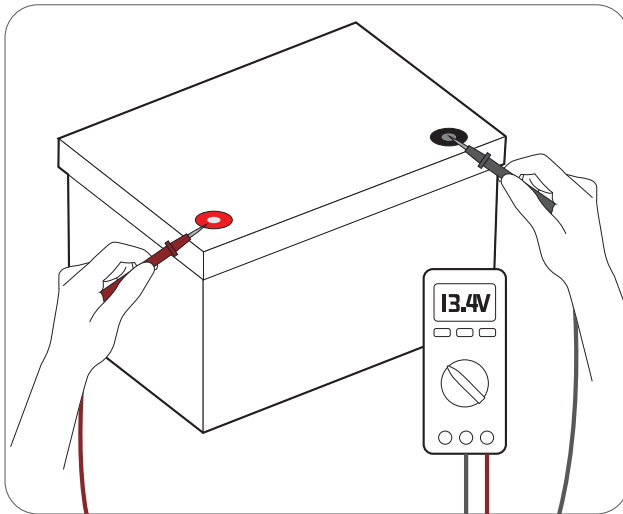

Tips:

When Testing the Battery Voltage with a Multimeter

- (1) Put the red probe (+) tightly on the positive terminal (not the post bolts), and the black probe(-) on the negative terminal.
- (2) Do not touch the metal part of the probes with your hands during use.



USING YOUR BATTERY

CONNECTION

THE PREMISE OF SERIES/PARALLEL CONNECTION

To connect in series or/and parallel, batteries should meet the below conditions:

1. Identical batteries with the same battery capacity (Ah) and BMS;
2. From the same brand (as lithium battery from different brands has their special BMS);
3. Purchased in near time (within one month).

LIMITATION FOR SERIES/PARALLEL CONNECTION

Support connecting up to 16 identical batteries for up to:

- 4 in series as 48V (51.2V) battery system.
- 4 in parallel as a 400Ah battery system.

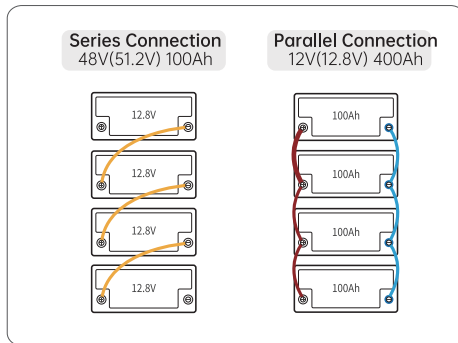

How to Connect Batteries

Step1: Wear Insulating Gloves

Wear Insulating Gloves for protection before connecting. Please pay attention to operation safety in the process of connection.

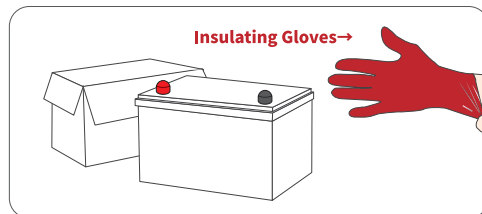

Step2: Voltage Balancing Before Connection

Below two steps are necessary to reduce the voltage difference between batteries and let the battery system perform the best in series or/ and in parallel.

1. Fully charge the batteries separately. (voltage at rest: $\geq 13.4V$)
2. Connect all of the batteries in parallel, and leave them together for 12- 24 hours.

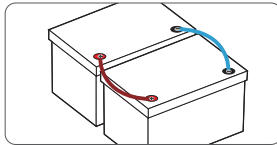

3. They're now ready for the connection.

Step3: Battery to Battery Connection

- ▶ 1. Connect Batteries in Series **+** to **-**

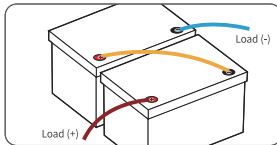

After the series connection, the voltage of the battery system will be doubled according to the number of batteries you connect.

E.g. If two 12V 100Ah batteries are connected in series, the battery system will be 24V (25.6V) 100Ah.

- ▶ 2. Connect Batteries in Parallel **+** to **+** / **-** to **-**
Refer to Page 11 for the total input & output connection

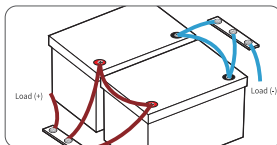

After a parallel connection, the capacity of the battery system will be doubled according to the number of batteries you connect.

E.g. If two 12V 100 Ah batteries are connected in parallel, the battery system will be 12V (12.8V) 200Ah

- ▶ 3. Connect Batteries Both in Series&Parallel
Connect in parallel first, then series.

a. Connect the batteries in parallel.

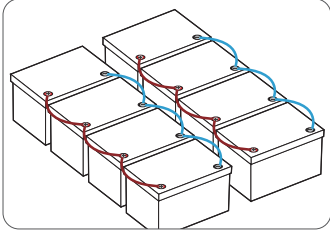

b. Connect the paralleled battery systems in series.

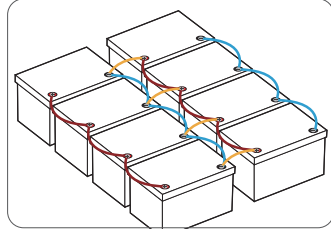

Step4: Total Input&Output Connection

Use two copper bars (instead of battery terminals) to connect all the positive and negative output/input cables, and make sure that the input&output currents of each battery are balanced. (Not required when connecting batteries only in series.)

Step5: Re-balancing Every 6 Months

It is recommended to re-balance the battery voltage every six months following Step 2 on Page 10 if you're connecting multiple batteries as a battery system, as there might be voltage differences after six months of the battery system running.

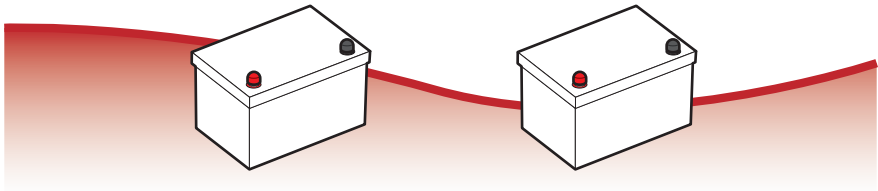

Wiring Diagrams

2P2S	
Battery System	24V (25.6V) 200Ah
Energy	5120Wh
Max. Continuous Charge/ Discharge Current	200A
Max Continuous Load Power	5120W

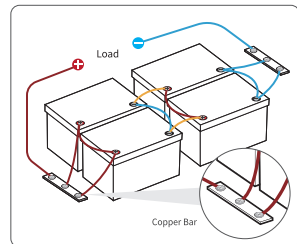

2P4S	
Battery System	48V(51.2V)200Ah
Energy	10,240Wh
Max. Continuous Charge/ Discharge Current	200A
Max Continuous Load Power	10,240W

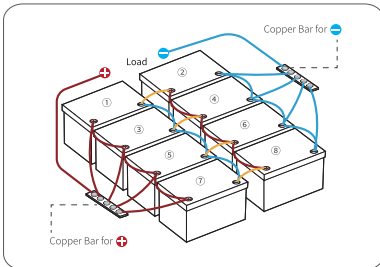
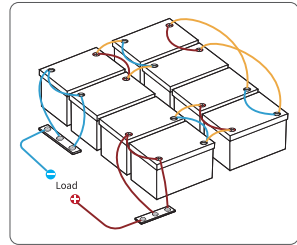

Tips:

It is not recommended to use one terminal as the total positive or negative output/input of the battery system as the connected terminals may heat up or even melt if the total output/input current of the battery system is too high.

4P2S	Battery System	24V (25.6V) 400Ah
	Energy	10,240Wh
	Max. Continuous Charge/Discharge Current	400A
	Max Continuous Load Power	10,240W

(1) As \ominus of 1/3/5/7 is connected in series with \oplus of 2/4/6/8, please do not connect \ominus of 1/3/5/7 with \ominus of load or \oplus of 2/4/6/8 with \oplus of load, otherwise the battery system will fail to connect in series.

(2) Please do not connect in reverse order, which may affect the use of the batteries.

Create Your Unique Wiring Diagram

Plan for your connection ...

Share with us your innovative ways to connect batteries



INSTALLATION

Step 1: Connect the positive terminal of the PV panel to the positive input of the MPPT PV terminal, and the negative terminal to the negative terminal.

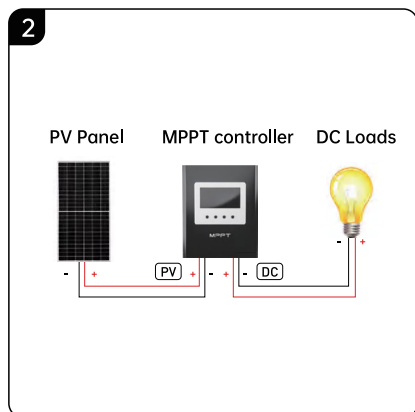
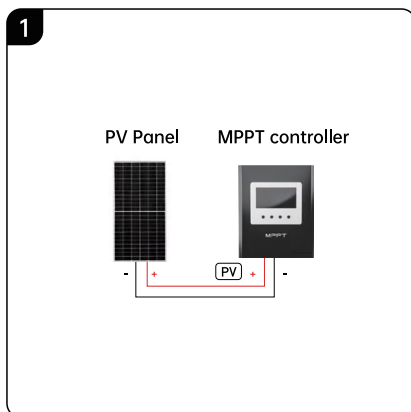

Step 2: If you want to connect the DC load directly, then connect the positive terminal of the DC load to the positive terminal of the MPPT DC connector and the negative terminal to the negative terminal.

Step 3: Let's use the copper bars to connect the positive terminal of the battery pack to the positive terminal of the MPPT BAT connector and the negative terminal to the negative terminal.

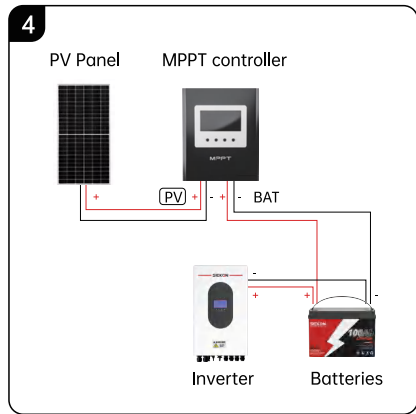
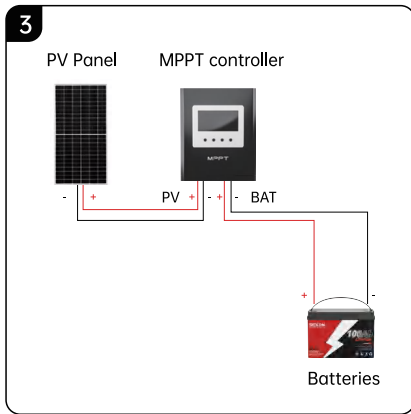

Step 4: Next, we need to connect the inverter to the battery, using copper bars to connect the positive battery pack (the same as in step 3) to the positive DC input port of the inverter, and the negative terminal to the negative terminal.

Step 5: Finally, we can connect our home appliances or AC loads directly to the inverter, thus forming a complete PV power storage system.

Now, let's see what our planned connected home PV power storage power system looks like.

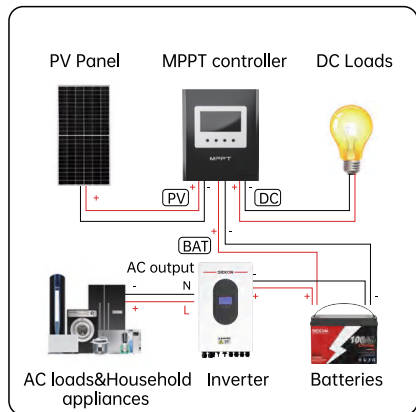
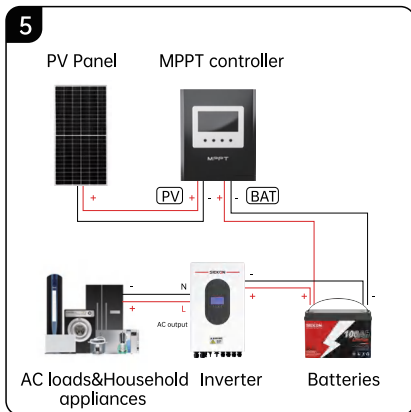

For more details on installing video, please check on our website: www.siekonenergy.com

INVERTER SETTING

Method 1: (Recommend)

Select "12V (14.6V) LI (LiFePO4) Mode "

Method 2:

If method one is not available, select "User Mode" to enter values according to the below parameters.

Charging	Charge Voltage	14.4V
	Over Voltage Disconnect	15V
	Over Voltage Reconnect	14.2V
Dis-charging	Under Voltage Warning	11.6V
	Under Voltage Recover	12V
	Low Voltage Disconnect	10.8V
	Low Voltage Reconnect	12.4V

The above setting parameters apply to common inverters on the market (such as Victron, Renogy, Growatt, Xantrex, Go Power, Lux Power, etc.) Different brands have slightly different descriptions or naming methods for each parameter. Please directly set the parameters with the same meaning.

If the inverter parameters to be set are special or cannot correspond to one of the above items, please contact support-online@siekonenergy.com for confirmation.

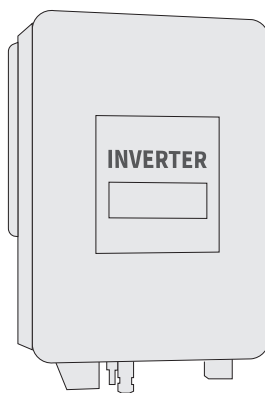

RECOMMENDED CABLE SIZING

Battery cables should be properly sized to handle the expected load. Refer to the table below for amperage ratings for different sizes of copper cables.

PVC COPPER CABLE SIZE (AWG/MM2)	14 (2.08)	12 (3.31)	10 (5.25)	8 (8.36)	6 (13.3)	4 (21.1)	2 (33.6)	1 (42.4)	1/0 (53.5)	2/0 (67.4)	4/0 (107)
AMPA CITY (A)	20	25	35	50	65	85	115	130	150	175	230

The above values are from NEC Table 310.15(B) 16 for copper cables rated at 167°F (75°C) operating at an ambient temperature not exceeding 86°F (30°C). Cables longer than 6 feet (1829 mm) or an ambient temperature higher than 86°F (30°C) may require heavier gauges to avoid excessive voltage drops with undersized ones.



HOW TO CHARGE YOUR BATTERIES

Battery Charging Logic

The material characteristics of the LiFePO₄ battery determine that its charging curve is obviously different from that of a lead-acid battery.

Compared with a lead-acid battery, the LiFePO₄ battery has a simpler charging process and mode. Therefore, it is recommended to select LiFePO₄ for your charging mode.

LiFePO4 Battery Charging Mode

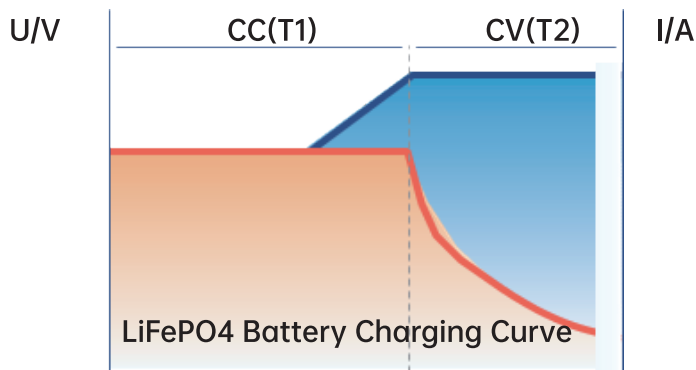

- ▶ CC (Constant Current) Phase (T1)

In the beginning, a discharged battery will be charged with a constant current and voltage will be climbing steadily until reaching the constant voltage setpoint which varies for different charging methods.

- ▶ CV (Constant Voltage) Phase (T2)

The battery maintains a constant voltage during this phase while the current gradually decreases to 2A (0.02C) which is also known as (tail Current1). At this point, the charging is cut off and the battery is fully charged.

* Tail Current (A)= Battery Capacity* 0.02C. E.g., 100A*0.02C=2A tail current

Solar Panel(s) & Controller

► Solar Panel

Recommended Power: $\geq 300W$

The battery can be fully charged in one day (with effective sunshine of 4.5 hours/-day) by 300W solar panels.

It may take more than one day to fully charge the battery with $\geq 300W$ solar panels since the duration and intensity of light would be a great factor for their charging efficiency.

► Controller

Recommended Charging Current:

20A (0.2C)	The battery will be fully charged in around 5hrs to 100% capacity.
50A (0.5C)	The battery will be fully charged in around 2hrs to around 97% capacity.

► Controller Settings

Refer to the below parameters if you need to manually set up your controller. As different types of batteries have different charging modes, it is recommended to set only the following parameters for LiFePO4 batteries. The settings for other types of batteries do not apply to LiFePO4 batteries except for the following settings.

CHARGING	Charge/Bulk/Boost Voltage	14.4V / 14.6V
	Absorption Voltage	14.4V / 14.6V
	Over Voltage Disconnect	15V
	Over Voltage Reconnect	14.2V
	Tail Current	2A (0.02C)
DIS-CHARGING	Under Voltage Warning	11.6V
	Under Voltage Recover	12V
	Low Voltage Disconnect	10.8V
	Low Voltage Reconnect	12.4V



TROUBLESHOOTING

If the battery is not working properly, the following methods can help you solve the general problem quickly.

If you are still unable to resolve a possible issue or need any assistance, please contact SIEKON at support-online@siekonenergy.com.

Problem	Cause	Troubleshooting Tips
Malfunction	No Voltage Output	The BMS enters a dormant or protected state. In this case, use the matching charger. Connect the charger terminals to the battery pack output positive-positive and negative-negative, then activate the battery pack with the charger.
	Over-Current Protection	Before using the batteries in parallel, measure the voltage of the batteries with a Multimeter, the two groups of batteries can be used in parallel if the voltage difference is below 100mV, if the voltage difference is above 100mV the parallel BMS will enter charging over-current protection, at this time disconnect the wires of the parallel batteries and use the charger to activate it to release the protection.
Battery Pack Failure	In Series Failure	It is forbidden to use more than 4 batteries in a series, as it will lead to battery failure, please disconnect immediately. If the individual battery cannot be used alone after disconnection. Please return to the factory for testing.
Undetected issues		Please feel free to connect to our helpful Customer Support Team support-online@siekonenergy.com



WARRANTY INFORMATION

Product Name	12.8V 100Ah LiFePO4 Battery
Model	RL-LARS1-12.8V100-XXXX
For your own reference, we strongly recommend that you fill in and save your order ID and date of purchase.	
Date of Purchase	
Order ID	



If you notice that your product is defective within the specified warranty period, please contact Customer Support via support-online@siekonenergy.com. DO NOT dispose of your product before contacting us.

Customer Support

Email: support-online@siekonenergy.com

Hotline: +1(909)345-9563

*Please have your order invoice and order ID ready before contacting Customer Support

Brand: SIEKON

Product Name: Lithium Iron Phosphate Deep Cycle Battery

Model Number: RL-LARS1-12.8V100-XXXX

Manufacture: ShenZhenDeChengDianZiShangWuYouXianGongSi

Address: 209-211, B dong ,huang pu dong huan lu 378 hao,huang pu she qu,shen zhen,guang dong, 518125, China



MADE IN CHINA

SIEKON
IDEAS FOR ENERGY