

# Mantis owner's manual

2020



# HEADS UP!

- 1** Tent Side: Please read chapter SITE SELECTION AND SETUP for instructions on raising, lowering and properly stowing your tent side to avoid **damage** when lowering roof.
- 2** Plumbing: Please read chapter PLUMBING SYSTEM for instructions in filling and draining the tanks and lines of the Mantis. Check chapter TROUBLESHOOTING for common mishaps.
- 3** Shower / WC Privacy Screen (if equipped): is hidden in plain site – it is stuffed into the small curtain/bag that hides the shower floor from view. Pull it out, attach the top 4 corners, snap the bottom, take a shower, change your clothes.
- 4** Wheel Lugs: On your first trip tighten wheel lugs at start and at 10, 25, and 50 miles. Thereafter, check wheel lugs before each trip, after excessive breaking and following winter. Always tighten to the manufacturer’s specification of 90 ft. lbs.
- 5** Before driving, make a habit of locking and dead bolting all doors and securing all window latches.
- 6** Keep an eye out – make a habit of walking around your trailer before you set out, when filling up at a service station, when hitching up at the campground. Preventative maintenance is always the best.
- 7** Have fun!



**WELCOME TO the 2020 MANTIS!**

Congratulations on your new Mantis! We hope you go somewhere we have never been (and tell us about it)!

The Mantis is for anyone. We were thinking mostly of a couple, or a couple with two teenagers. Who knows what you are thinking! With two hammocks and a rooftop tent added you could sleep 8! We are always thinking of how small something can be AND how big things need to be; sometimes this means space and light, sometimes it means gear, sometimes aerodynamics, sometimes a rainy day, sometimes just a feeling.

Please have a great time. Please support our nations' park systems. It takes work to keep things wild.

Please take what you need and leave nothing behind! Keep everyone else's adventures pristine. Please be safe!

*It is important that you thoroughly review this Owner's Manual. Please also consult it anytime you have a question regarding the use, operation and maintenance of your trailer, and its systems and components. Your Mantis trailer has multiple systems, parts, and components, and understanding how they work is an important part of having a fun, safe travel experience.*

We want your first and every adventure to be great. Have a practice session in your driveway. Hitch that trailer up and drive it around the block. Get comfortable. Ask questions! Get answers to any questions, issues or problems that arise during your practice. Get answers from the tribe, from our FAQs, at your dealer or call us up. Give us a call or email us at **customer service@taxaoutdoors.com**. Many questions can be answered quickly and easily and save you a lot of hassle.

Best,

Garrett Finney,  
TAXA Founder

A handwritten signature in black ink, appearing to read "Garrett Finney". The signature is fluid and cursive, with a large loop at the end.



## **YOUR OWNER'S MANUAL (AND OTHERS)**

Make this Owner's Manual a permanent part of your trailer, download it to a smart device or print it out to keep it with the trailer at all times. Keep the manuals, stickers and tags associated with your trailer's items, add-ons, appliances and equipment in the trailer as well.

This manual is not intended to be inclusive of every operational aspect of your unit. It should be utilized and referenced by you in conjunction with the separate, additional manuals provided by the manufacturers of the different components, component parts, appliances, add-ons, systems, and accessories in your unit. Your unit will contain any such manuals provided to Taxa Inc. by the specific component part, appliance, add-on, system, and accessory manufacturer. You can also find the latest updates and copies online at our website. Please read them to gain a more complete understanding of the operation and maintenance of the products and appliances installed in your trailer.

**READ THE ENTIRE MANUAL AND OBEY ALL CAUTION, WARNING, DANGER AND OTHER SAFETY-RELATED STATEMENTS PRIOR TO OPERATING YOUR TRAILER.**

### **please note**

This Owner's Manual contains the most up-to-date product information available at the time of publication. However, due to continuous product development, innovation and improvements, Taxa Inc. reserves the right to make changes in production techniques/processes, product materials, product specifications and components. Such changes may be made without prior notice or any obligation upon Taxa Inc. to make corresponding changes or improvements in or upon its already manufactured, installed and/or sold trailers and/or products. Please visit our website at [www.taxaoutdoors.com](http://www.taxaoutdoors.com) to check for manual updates and our current manual.



**Table of Contents**

WELCOME TO the 2020 MANTIS!..... 3

YOUR OWNER’S MANUAL (AND OTHERS) ..... 4

SAFETY TERMS..... 5

OVERVIEW OF SAFETY PRECAUTIONS ..... 6

HITCHING ..... 7

LOADING ..... 9

TOWING.....11

BRAKES .....13

TIRES.....14

MANTIS DESCRIPTION.....17

PLUMBING .....22

ELECTRICAL SYSTEM.....30

BATTERY .....39

PRE-TRAVEL CHECKLIST.....43

SITE SELECTION AND SET UP .....44

VENTILATION.....46

FOUR SEASON USE / EXTREME WEATHER.....48

GENERAL CARE AND MAINTENANCE.....50

STORAGE, WINTERIZATION & BRINGING OUT OF STORAGE.....52

TROUBLESHOOTING .....53

LIST OF AUTHORIZED DEALERS.....56

your Mantis LIMITED WARRANTY.....57

**SAFETY TERMS**

We have included various safety messages in this manual, all of which are important. Please read and obey them. The following are safety-related terms and symbols referred to in this manual and their corresponding meanings/definitions:

DANGER indicates an imminently hazardous situation that, if not avoided, will result in death or serious injury.

WARNING indicates a potentially hazardous situation that, if not avoided, could result in death or serious injury.

CAUTION indicates a potentially hazardous situation that, if not avoided, may result in minor or moderate injury.

NOTICE is used to address practices not related to personal injury. This applies to hazardous situations involving property damage or important information regarding the maintenance of your vehicle.



## OVERVIEW OF SAFETY PRECAUTIONS

You'll find various safety-related references, discussions and instructions throughout this owner's manual, and all of them are important. This overview is not an exhaustive list of the safety issues discussed or contemplated in this manual. Please carefully read and follow all safety issues discussed in this manual. If you have any questions regarding trailer safety issues, please contact your dealer and/or Taxa Inc. ([customerservice@taxaoutdoors.com](mailto:customerservice@taxaoutdoors.com) takes you to all of us – general questions, service, warranty, sales)

The following is a broad snapshot of a few of the more common safety instructions/discussions/issues in the use and operation of your new trailer:

- Be sure load/cargo weight does not exceed your GVWR and that weight is distributed properly before travel. Please refer to the "Loading" section.
  - *fully close-up and lock your trailer before towing ...* to ensure efficient and safe transportation.
  - Be sure safety chains and breakaway switch have been properly attached and secured as part of your hitching up process.
  - Be sure to have a qualified technician conduct the maintenance, service and adjustments on your brakes periodically and as needed. Do NOT travel until all brake problems, if any, are fixed. See "Brakes" section.
  - Test your brakes and lights before towing on a public road, confirming that they are working properly and in synchronization.
  - *do not allow passengers to ride in the trailer during travel ...* the transport of people puts their lives at risk and is illegal. Your trailer does not have seat belts and is not designed to carry passengers.
  - *tires ... be vigilant in your tire inspection and maintenance.* Properly maintained tires improve the steering, stopping, traction, and load-carrying capability of your trailer and tow vehicle. Under-inflated tires and over-loaded vehicles are major causes of tire failure. Please refer to "Tires" section for a more detailed discussion on your tires and tire safety.
  - Keep your trailer well-ventilated. Please refer to the "Ventilation" section for details.
  - Clean your potable water hose, and drain and clean holding tanks periodically and / or as needed.
  - Be sure all electrical uses and activities involve proper grounding.
- *reduce fishtailing & sway ...* excessive sway of your travel trailer can lead to the rollover of the trailer and tow vehicle resulting in serious injury or death. This usually due to incorrectly loading the trailer but can also indicate road conditions or trailer damage. You may choose to install a separately purchased sway control device to help reduce sway. Be sure to contact your dealer or Taxa Inc. if you have any questions regarding sway control device alternatives. Please also refer to the sway and fishtailing discussion in the "Towing" section.
- *generator safety ...* if you decide to use a generator, do not operate it inside the trailer or in any other enclosed space. Be sure to follow all instructions and warnings in the manual provided with the generator, if any.
  - *lug nut torque ...* be sure wheel mounting nuts (lug nuts) on trailer wheels are tight and properly torqued. Inadequate and/or improper wheel nut torque (tightness) is a major reason that lug nuts loosen. Loose lug nuts can rapidly lead to a wheel separation with potentially serious safety consequences. Refer to a qualified technician before travel if you have any questions regarding your wheel nut torque. See also "Tires" section.
  - *appliances and equipment ...* some Mantis equipment (cooktop, furnace, etc.) operate on propane. Propane is highly flammable and contained under high pressure. Improper use may result in a fire and/or explosion. Be sure to follow the instructions and warnings provided by the manufacturer of such appliances, if any.

## HITCHING

Our trailers require a 2" diameter hitch ball. *Use of any other hitch ball diameter size will create an extremely dangerous condition that can result in separation of the coupler and ball, and/or hitch ball failure.* Other than this crucial 2" diameter requirement, there are numerous trailer hitches and hitching components available to you for your trailer. Be sure to consult your tow vehicle manufacturer for hitch and/or hitch assembly alternatives.

*pre-hitch/coupling/trip considerations and inspection ....* be sure your hitch and tow vehicle are rated for the Gross Vehicle Weight Rating (GVWR) of your trailer. Remember that the hitch load rating must be equal to or greater than the coupler load (the hitch is attached to the car, the coupler to the trailer). Be sure the hitch size matches the coupler size.

Examine all hitch components before hitching, looking for wear, corrosion, deformations, stripping and cracks. Replace worn, corroded or cracked hitch components before coupling the trailer to the tow vehicle. Be sure the hitch components are tight and that the ball-locking device works freely before coupling the trailer to the tow vehicle. Remember to also inspect the safety chains. Be sure to correct any noted problems or defects before towing the trailer.

Important Note: be sure to raise all trailer jacks and close the trailer fully before hitching (i.e. close all doors and windows and raise the step ladder).

Your trailer is equipped with a 7-pin connector, which synchronizes the lights of your tow vehicle and trailer. It can also connect their respective braking systems. Your trailer is equipped with electric brakes and an AUTOWBRAKE brake controller. You will need to synchronize the autowbrake and the fob before safe towing can occur. Electric brakes are not required in every State, however, we recommend that you use them.

**WARNING: THE PROPER SELECTION AND CONDITION OF THE COUPLER AND HITCH IS ESSENTIAL TO THE SAFE TOWING OF YOUR TRAILER. A LOSS OF COUPLING MAY RESULT IN DEATH OR SERIOUS INJURY.**

**WARNING: AN IMPROPERLY COUPLED TRAILER CAN RESULT IN DEATH OR SERIOUS INJURY.**

**WARNING: USE OF A TOW VEHICLE WITH A TOWING CAPACITY LESS THAN THE LOAD RATING OF THE TRAILER CAN RESULT IN LOSS OF CONTROL, AND MAY LEAD TO DEATH OR SERIOUS INJURY.**

Hitching up your trailer will get easier with practice. The hitching steps described below are typical. However, we highly recommend that you also consult the hitching and unhitching instructions associated with your particular tow vehicle and hitching configuration.

*hitching steps and instructions:*



- (1) crank the tongue of the trailer jack until the hitch coupler is raised enough to clear the tow vehicle;
- (2) back the tow vehicle to the trailer until the hitch ball is directly under the trailer coupler. The use of a backing aid mirror may be helpful, especially if you are hitching alone;
- (3) set the parking brake in the tow vehicle;
- (4) be sure the coupler latch-locking lever is fully open, and then lower the tongue jack until the ball is firmly seated in the socket;



(5) close the coupler latch and secure it with a locking pin or bolt (*you can use the pin that locks the caster wheel on to the front jack*); If you cannot get the latch to go down try pulling the tow vehicle forward a few inches.

(6) securely attach the safety chains in a crossing pattern to the tow vehicle and confirm that they are properly connected to the trailer. Do not fasten chains to any part of the hitch unless the hitch has holes or loops designed specifically for that purpose, be sure the chains do not drag during towing;

**WARNING: IMPROPER RIGGING OF THE SAFETY CHAINS CAN RESULT IN LOSS OF CONTROL OF THE TRAILER AND TOW VEHICLE, LEADING TO DEATH OR SERIOUS INJURY, IF THE TRAILER UNCOUPLES FROM THE TOW VEHICLE.**

(7) Synchronize the AUTOWBRAKE and key fob before towing. <https://taxaoutdoors.com/wp-content/uploads/2019/05/Autowbrake-Installation-Manual.pdf>

(8) Connect the breakaway switch. Attach and secure the breakaway switch cable to the tow vehicle bumper or frame independently of the safety chains. The following are guidelines for attaching the cable:

The cable should come straight out from the switch to attach to the tow vehicle  
The switch and cable should be located and secured on the same side of the trailer and tow vehicle  
Do not loop the cable over the hitch ball; the cable may bounce off while the vehicle is moving  
Before towing you may test the breakaway assembly by pulling the pin out of the switch to confirm activation of the trailer electric brakes. See also the diagram/depiction in "Towing" section.

**WARNING: DO NOT CONNECT THE BREAKAWAY SWITCH LANYARD TO THE HITCH BALL OR ANY PART OF THE HITCH ASSEMBLY.**

Note: your breakaway switch will automatically engage the electric trailer brakes if the safety chains fail during uncoupling.

(8) connect the power cord between the tow vehicle and the trailer, leaving enough slack for the tow vehicle to turn without disconnecting the power cord;



coupler securely latched and pinned

trailer wiring plugged securely into tow vehicle, lights tested

chains crossed and securely attached to frame of hitch

breakaway switch cable attached to tow vehicle separate from chains

(9) adjust side mirrors;

(10) check all lights on trailer and tow vehicle, ensuring that they are communicating properly; and

(11) confirm the brakes are working properly prior to towing the trailer on a public road. You can, for example, check the operation of the trailer brakes by pulling forward and using the hand control, if any.

(12) You may, depending on your tow vehicle or intended usage of the trailer, want to consider the use of a weight distributing hitch and or sway bars. These distribute the tongue weight of the trailer further away from the rear and can help in vehicle handling.



(example of weight distributing hitch assembly)**FOLLOW ALL INSTRUCTIONS PROVIDED BY YOUR VEHICLE'S TOW PACKAGE MANUFACTURER AND/OR INSTALLER.**





## LOADING

The process of safely and properly loading your trailer should become easier with practice and experience. Please first get familiar with and understand the following terms related to your trailer's weight, carrying capacity, and rating:

*gross vehicle weight rating (GVWR)* is the maximum permissible weight of the trailer when fully loaded and equipped/outfitted. It includes but is not limited to all weight at the trailer axle(s) and tongue or pin as well as all add-ons, appliances, accessories, potable water, etc. Your trailer's GVWR is 3970 lbs. This number is recorded on the permanent label on the tongue of your trailer.

*unloaded vehicle weight (UVW)* is the weight of the trailer as manufactured at the factory (standard weight). It includes all weight at the trailer axle(s) and tongue or pin. Your trailer's standard UVW is approximately 2882 lbs. However, you will need to account for the weight of dealer or third-party installed add-ons, options and accessories, if any, in determining your actual UVW. In sum, your actual UVW will vary (and increase) to the extent you have outfitted your trailer with additional items. Note: Your cargo carrying capacity (discussed below) will vary (and decrease) to the extent of the weight of dealer or third-party installed add-ons, options and accessories, if any.

*cargo carrying capacity (CCC)* is equal to GVWR minus UVW and potable water weight. Your trailer's CCC is approximately 1088 lbs. However, remember that your actual CCC will vary (and decrease) to the extent you have outfitted your trailer with additional items. Please refer to the stickers located at the front exterior of your trailer for CCC.

*gross axle weight rating (GAWR)* is the value specified as the load carrying capacity of a single axle system, as measured at the tire-ground interfaces. Your trailer's GAWR is 3970 lbs. Please refer to the sticker located at the front exterior of your trailer for GAWR.

*gross trailer weight (GTW)* is the weight of the trailer with all the items and supplies that are loaded into the unit at any point in time.

## WEIGHT GENERALLY

Before towing, you must choose the items you will load onto your trailer and then determine whether the loaded weight is safe and proper. Of course, the best way (highly recommended) to calculate the loaded weight of your trailer is to have it weighed while loaded, and then compare it with the GVWR (3500 lbs.). Otherwise, you will need to do some calculations on your own in order to make an appropriate determination. If the loaded weight of your trailer exceeds the GVWR, your trailer is overloaded and should not be towed. You will need to remove items from, and reduce the loaded weight of, the trailer until it's at or below the GVWR before towing. Note: remember to include in your calculations the weight of dealer or third-party installed equipment, options, add-ons, accessories and any other non-standard items. *As an additional safety precaution, we recommend that you take a conservative approach when doing your own weight calculations.*

## WEIGHT/LOAD DISTRIBUTION AND TONGUE WEIGHT

Proper weight and load distribution is essential to safe towing. Load the trailer evenly (front to back and side to side) and securely, keeping heavier items as low as possible. Be sure to secure the load. A firmly secured load will be less prone to shifting and should help maintain load balance during travel.

Tongue (the trailer arm extension that couples with the tow vehicle receiver) weight is the amount of weight borne by the trailer hitch and another important consideration when loading your trailer. Generally, the actual tongue weight should equal approximately 10-15% of the gross trailer weight. Excessive tongue weight will make your tow vehicle's steering and braking less responsive. Insufficient tongue weight may cause your trailer to sway.

You could weigh your loaded trailer's tongue to determine the actual tongue weight. However, you may also observe the actual tongue weight and determine if it is too light or too heavy. For example, a trailer with a proper tongue weight will form a straight line from front to back between the tow vehicle and the trailer. A trailer with the weight improperly distributed (i.e. a light tongue weight) will cause the coupling between the tow vehicle and trailer to rise, with the weight pressing down at the rear of the trailer and the front of the tow vehicle. Excessive tongue weight will do just the opposite.

If you notice a rise or fall in your tow coupling, you will need to redistribute the weight of the load before getting on the road. If you have trouble estimating the combined weight of your trailer plus cargo, take your loaded trailer to a vehicle scale at a nearby weigh station or truck stop. *Important Note: you need to also refer to your tow vehicle's towing capacity and other towing and load capacity-related definitions and instructions before getting on the road. Please also consult your supplying dealer or Taxa Inc. if you have any questions regarding these terms and/or loading your trailer.*

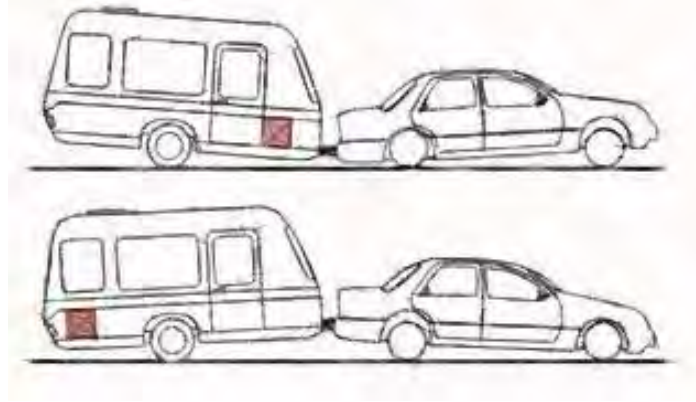

**example of poor weight distribution**



**proper ~10 to 15% of trailer on car coupler**

## TOWING

We want your towing experiences and practices to be safe and enjoyable. Please take your time, avoid being in a rush and give special attention to all safety matters prior to and during the towing of your trailer.

As previously indicated, we recommend that you practice towing your Mantis in, for example, an empty parking lot before going on your first camping trip. This initial trial and practice is fun and will help you get accustomed to and familiar with Mantis's systems and operation. Please also make note of any questions, issues or problems that arise during your pre-travel towing practice, and then inquire with your dealer or email us [customerservice@taxaoutdoors.com](mailto:customerservice@taxaoutdoors.com). You can also visit our website ([www.taxaoutdoors.com](http://www.taxaoutdoors.com)) for more contact information. Please also refer to the "Overview of Safety Precautions" and "Pre-Travel Checklist" sections before towing your trailer.

*safety chains* ... We have equipped your trailer with safety chains. Make use of them. Safety chains serve to maintain the connection between your trailer and the tow vehicle in the event of separation of the ball and trailer coupling. Be sure to hook the safety chains to the frame of the tow vehicle (not the hitch), crossing them under the trailer's tongue. Also, remember to inspect the length of the chains once they are attached to the tow vehicle frame. A proper chain length will allow turns and prevent the chains from dragging on the road.

*breakaway switch* ... Your trailer is equipped with a breakaway switch. For every Mantis the breakaway switch is wired to the Mantis's internal battery. Breakaway switches are designed to activate the electric brakes in the event your trailer disconnects/uncouples from the tow vehicle. Your trailer battery powers this braking. Ideally, the safety chains will prevent your trailer from disconnecting if the coupler comes off the hitch ball. However, if the safety chains fail, the breakaway pulls the pin out of the switch which fires the brakes and serves as a last line of defense against a runaway trailer. The breakaway switch cable needs to be secured to the tow vehicle bumper or frame independently of the trailer safety chains. The following are guidelines for attaching the cable:

- The cable should come straight out from the switch to attach to the tow vehicle
- The switch and cable should be located and secured on the same side of the trailer and tow vehicle
- Do not loop the cable over the hitch ball; the cable may bounce off while the vehicle is moving
- Before towing you may test the breakaway by pulling the pin out of the switch to confirm activation of the trailer electric brakes. See below



switch location

cable attached independently to tow vehicle, with pin secured in switch

*tire pressure* ... you are responsible for maintaining proper tire pressure in the tires of your trailer and tow vehicle. Thus, always check your tire pressure and refer to the "Tires" discussion herein before traveling.

*brakes* ... you are responsible for inspecting and maintaining both your trailer and tow vehicle brakes before towing. Do not tow your trailer unless you have confirmed your brakes are in good condition and operating properly. Be sure to have a qualified technician perform all brake adjustments, service and maintenance. Please also refer to the "Brakes" discussion herein before traveling.

*lights* ... be sure to check all electrical connections to ensure all lights on the tow vehicle and trailer are functioning properly before traveling. The brake lights, and hazard and turn signals should be in synchronization with the tow vehicle.

*stay level* ... the trailer and tow vehicle must be level when hitched. Dragging may occur if the hitch is too low. Conversely, if the hitch is too high, the rear of the trailer is exposed to striking higher points in the road.

*general towing/driving* ... drive defensively, anticipating stops, braking early, and never following closely. We recommend maintaining a length of at least three cars and a trailer (approximately 65 ft.) between you and the car in front of you for every



10 mph of speed you are traveling (for example, at 60mph, you should maintain approximately 390 ft. of distance between your vehicle and the vehicle in front of you). This should give you adequate time to safely complete a proper avoidance maneuver (i.e. come to a safe stop, change lanes, etc.) in the event of, for example, an abrupt stop or emergency.

Longer stopping distances are required when towing a trailer so remember to start braking sooner than you would if driving without your trailer. Begin slowing down well in advance of anticipated street/road dips and depressions. It also takes longer to accelerate when towing a trailer. Thus, remember to account for both the slower acceleration rate and the combined length of your tow vehicle and trailer when passing another vehicle and then safely returning to your lane. In sum, always pass, allow others to pass, and change lanes with care. We also do not recommend using cruise control or overdrive when towing/travelling.

**SWAY AND FISHTAILING** ... excessive sway or fishtailing of your trailer can lead to the rollover of the trailer and tow vehicle, and thus, serious injury or death. The tendency for the vehicle to sway increases with speed. Thus, reduce speed as needed and in inclement or harsh weather conditions (i.e. high winds, rainstorms, slippery roads, etc.). The following are a few tips for reducing sway or fishtailing if and when they occur and are not exhaustive: (1) *slow down gradually* .... do not jam/slam on the brakes or press on the accelerator, both of which may make the situation worse and result in severe injury or death. Instead, remove your foot from the accelerator and reduce your speed gradually whenever possible; (2) *minimize and avoid quick steering movements* .... Quick steering movements will actually cause increased sway and loss of control; Keep both hands on the wheel, and hold the wheel as straight as possible until stability is regained; and *As soon as practicable after regaining control* ... pull over and check tire pressures, cargo weight distribution, and inspect the trailer and tow vehicle for any signs of failure or defect. If you suspect a mechanical failure, we recommend that you not tow until the problem is identified and remedied. If you choose to travel, do so at reduced speeds and with heightened caution until the problem can be identified and remedied.

**WARNING: Side to side motion (sway) that begins as you reach a certain speed will likely become whipping at higher speeds. As soon as you notice sway, slow your vehicle by letting off the gas pedal. Then stop to check the trailer and tow vehicle as soon as it is safe to do so. Often sway can be temporarily controlled by pressing the brake controller's brake button independent of touching the tow vehicle's brake. This tends to pull the trailer back in line and gives greater control as one determines the issue at hand.**

#### **OTHER IMPORTANT TOWING SCENARIOS**

*winding, narrow roads* ... stay in the center of the lane. This reduces the likelihood of the tires/wheels dropping onto the shoulder, another potential cause of hazardous sway. Do not cross the center-line unless safely changing lanes.

**WARNING: If a wheel goes off the paved roadway, do not steer sharply and do not brake. Let off the gas pedal, slow down below 25 mph and then steer gradually back onto the roadway. Proceed with caution entering traffic.**

*sharp turns* .... minimize the suddenness of sharp turns by anticipating them, slowing down well in advance of them, and taking them at low, substantially reduced speeds.

*steep, long grades* ... like sharp turns, be sure to anticipate steep grades. Down-shift into a lower gear or range in advance to assist your braking on a descent and to add power on a climb.

Note: avoid situations that require excessive and prolonged use of the brakes. If unavoidable, apply and release brakes at short intervals to give them a chance to cool. Downshift your tow vehicle to reduce braking needs on long downgrades of highway.

*slippery, icy pavement* ... reduce speed and drive slowly. Remember that skidding/hydroplaning can occur with minimal moisture on the road. If skidding occurs, remove your foot from the accelerator and then gently apply the trailer brakes only.

*freeways and highways* ... try to pick and stay in the far righthand slow(er) lane.

*corner turns* ... trailer wheels do not follow the path of your tow vehicle's wheels during corner turns. The trailer will make a closer, tighter turn than the tow vehicle. Compensate by moving further into the intersection before turning so that the trailer clears any objects in or near the road such as but not limited to the curb and parked vehicles. Left turns require a wider than normal turn to help prevent the trailer from edging into an opposing lane. Use turn signals early for the traffic behind you and begin slowing down well in advance of your turn.

*mud and sand* ... when going through mud or sand, accelerate gently, if at all, and try to remain in the path of the previous vehicles. Let the momentum of the tow vehicle and trailer carry you through the problem area. If stuck, the trailer and tow vehicle should be towed out while hitched.



*dirt, gravel, washboard roads ... go slow, use caution, your trailer will move and vibrate more than the tow vehicle, a good rule of thumb is 25 mph or less, MUCH less on severely rutted roads.*

*parking ... Whenever possible, avoid parking on a grade. If unavoidable, turn the front wheels of your tow vehicle into the curb and set the parking brake. For added safety, place wheel chocks under the trailer wheels.*

*additional towing safety information ... can be found on the National Highway Traffic Safety Administration's web site:<http://www.nhtsa.dot.gov/Cars/problems/Equipment/towing/Towing.pdf>*

## **BRAKES**

*overview .... your Mantis is equipped with electric brakes and a wireless proportional brake controller. Under normal driving/towing conditions, the trailer brakes will operate only in conjunction with a properly installed brake controller (which is also discussed below). Please also obtain and read the separate manual of the brake controller.*

**Important Note:** in an emergency uncoupling of your tow vehicle and trailer, your trailer electric brakes will automatically engage even without a brake controller. This assumes, of course, that you have properly attached and secured the provided breakaway switch. See also "Hitching" and "Towing" sections herein.

*brake controller, breaking-in your brakes and synchronization ...we recommend that you break-in your trailer brakes in, for example, an empty, paved parking lot, not on a public road, when practicable. To break-in your brakes, apply the brakes at least twenty (20) times, decreasing your speed approximately 20 mph in each application. Allow a few minutes for the brakes to cool between each application so that the brake shoes and magnets "wear-in" to the drum surfaces.*

When a brake control or controller is properly installed, your trailer electric brakes will work in synchronization with your tow vehicle brakes. If you sense lock-up, "grabiness," or your trailer "jerking" or "pushing" the tow vehicle when braking, your braking systems are not properly synchronized. You may need to have small adjustments made periodically because of, for example, changing loads and driving conditions. Brake Controllers are proportionally adjustable and small adjustments are easily made. **Important Note:** be sure to refer to and follow your brake controller manual for instructions on synchronization, use, maintenance and adjustments.

**CAUTION:** Minimum vehicle stopping distances are achieved when wheels approach lock up. Brake lock up should be avoided as it results in poor vehicle stability and control.

*connector ... your provided 7-pin cord connector located at the front of the trailer transfers electrical power from the tow vehicle battery to the trailer brakes, lighting system, and battery.*

*braking tip ... do NOT use the trailer brakes only . They were designed to provide braking for your trailer, not the tow vehicle. Remember that the added weight of both the trailer itself and the cargo you are carrying can put additional load pressures on your tow vehicle brakes. It also may, under some conditions (i.e. slippery pavement, loose gravel, etc.), impact overall stability and control of your tow vehicle and trailer. Thus, be sure that you have all the information you need to make an informed decision regarding your brakes before getting on the road.*

*brake adjustments ... generally, brakes should be adjusted after the first 200 miles, every 3,000 miles thereafter, and/or as use and performance requires. We recommend that you have a qualified technician perform all brake adjustments, service and maintenance.*

**THE AUTOWBRAKE IS A SELF-CONTAINED FULLY FUNCTIONAL, ELECTRIC BRAKE CONTROL** that is installed with your vehicle. Visit <https://getautowbrake.com/> for more information on calibration and setting changes.





## TIRES

**size: ST 235/75 R 15 pressure: max 50psi cold**

*overview...* Properly maintained tires improve the steering, stopping, traction, and load-carrying capability of your vehicle. Under-inflated tires and overloaded vehicles are a major cause of tire failure. **Maintaining proper tire pressure, tire and vehicle load limits, avoiding road hazards, and regularly inspecting tires for cuts, slashes, and other irregularities are important steps in avoiding tire failure, such as tread separation or blowout and flat tires.** These steps, along with other care and maintenance activities, may improve vehicle handling, help protect you and others from avoidable breakdowns and accidents, improve fuel economy and increase the life of your tires. In sum, you are responsible for making tire safety a regular part of your tow vehicle and trailer maintenance routine. Remember that the time you spend is minimal compared with the inconvenience and safety consequences of tire failure.

*proper wheel nut torque* is essential to safe towing. The wheel and axle systems used in trailers are similar in many ways to those found in motor vehicles. However, they differ in several important ways. First, trailer wheels do not steer, and are subjected to high side load stress when making tight turns around corners. This tends to flex the wheel and loosen the wheel nuts. Wheel nut torque requirements vary depending on the size and manufacturer of the wheel.

### TIRE FUNDAMENTALS

Federal law requires tire manufacturers to place standardized information on the sidewall of all tires. This information identifies and describes the fundamental characteristics of the tire and also provides a tire identification number for safety standard certification and recall matters.

*Sidewall markings and important terms ...* your trailer tires should be marked with either a designation of "ST" (i.e. ST235/75/R15, or LT235/75/R15). The "ST" indicates Standard Trailer Service and designed for trailer use only. The "LT" indicates Light Truck Service and designed to be used on vehicles that are capable of carrying heavy cargo.

*maximum load rating ....* Is the maximum load in kilograms and pounds that the tire can carry.

*maximum permissible inflation pressure ...* is the greatest amount of air pressure that should be put in the tire under normal driving conditions.

*max. load single kg (lbs) at kPa (psi) cold* -This information indicates the maximum load and tire pressure when the tire is used as a single.

*load range ....* identifies the tire's load-carrying capabilities and its inflation limits.

### TIRE TREAD

The tire tread provides the gripping action and traction that helps prevent your vehicle from slipping or sliding, especially when the road is wet or icy. Generally, tires are not safe and should be replaced when the tread is worn down to 1/16 of an inch. *The following chart is a general guide for determining the condition of and maintenance action for your trailer tires:*

*replacement ...* please refer to the tire sidewall on your trailer's standard tires for information regarding proper tire replacement. Be sure to replace your standard trailer tires with "ST" designated tires. Note: replacing your trailer tires with non-ST designated tires will void the Limited Warranty. See Limited Warranty section herein. If you have any doubt about the correct size/type to choose, consult with a tire dealer. Please also refer to the manual provided by your specific tire manufacturer for care and use instructions.

*repair ....* the proper repair of a punctured tire requires a plug for the hole and a patch for the area inside the tire that surrounds the puncture hole. Punctures through the tread may be repaired if they are not too large, but punctures to the sidewall should NOT be repaired. Tires must be removed from the rim to be properly inspected before being plugged and patched.

**ALL TIRE REPAIRS SHOULD BE PERFORMED BY A QUALIFIED TECHNICIAN.**

### TIRE PRESSURE AND LOAD LIMITS

Tire inflation pressure is the level of air in the tire that provides it with load-carrying capacity and affects the overall performance of the vehicle. Because tires may naturally lose air over time, or when driven over objects such as potholes or curbs, it is important to check tire pressure monthly and before every trip.

The tire inflation pressure number indicates the amount of air pressure—measured in pounds per square inch (psi)—a tire requires to be properly inflated. Vehicle manufacturers determine this number based on the vehicle's design load limit, that is, the greatest

amount of weight a vehicle can safely carry and the vehicle's tire size. Excessive loads may lead to abnormal tire flex, tire overheating, and ultimately, tire failure. As travel trailers may be set up and loaded in varying ways, proper air pressure should be determined by referencing the information on your tire. Please also refer to the Tire and Loading Information sticker located at the front exterior of your trailer.

The proper tire pressure for your vehicle is referred to as the "recommended cold inflation pressure." Proper pressure depends on many conditions – terrain, temperatures, altitude, etc. A "cold" tire in this sense is one that has not been driven on for at least three hours. When you drive, your tires get warmer, causing the air pressure within them to increase. Therefore, to get an accurate tire pressure reading, you must measure tire pressure when the tires are cold or account for the extra pressure in warm tires.

**WARNING:** Improper tire pressure can quickly lead to excessive wear and dangerous situations.

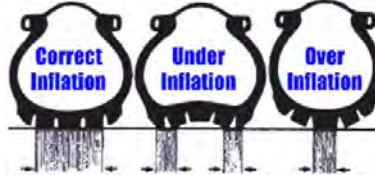

*tire pressure steps:*

- Locate the recommended tire pressure on the vehicle's tire.
  - Record the tire pressure of all tires.
  - If the tire pressure is too high in any of the tires, slowly release air by gently pressing on the tire valve stem with the edge of your tire gauge until you get to the correct pressure.
  - If the tire pressure is too low, note the difference between the measured tire pressure and the correct tire pressure. These "missing" pounds of pressure are what you will need to add.
- At a service station, add the missing pounds of air pressure to each tire that is under-inflated.
- Check all the tires to make sure they have the same air pressure (except in cases in which the front and rear tires are supposed to have different amounts of pressure).

*remember:*

Do not exceed the maximum recommended pressure.  
 The air pressure recommended on the tire information placard is for the original standard equipment tires only. Your trailer may be equipped with optional-sized tires. Always follow the pressure recommendations stamped in the tire sidewall for any replacement tire.  
 Rotate tires every 5,000 miles or as recommended by the tire manufacturer.

**WHEEL NUT TORQUE ADJUSTMENTS**

*setting torque value on a dial indicator wrench:*

Make sure your indicator needle is set to "0".  
 As you apply clockwise pressure to the wheel nut, both needles will show the current amount of torque being applied.  
 When you reach your desired torque value, stop applying pressure and your indicator needle will stay at the highest torque value reached.

*setting torque value of adjustable dial wrench:*

Unlock the handle and set the dial to your desired torque value.  
 Lock the handle back in place.  
 As you apply clockwise pressure to the lug nut, you will hear and audible "click" when the desired torque wrench value is reached.  
 Do not apply further pressure once you hear the "click".

*pre-trip torqueing procedure:*

Be sure to tighten the wheel nuts and torque to 90 lbs. Follow the torque sequence and torque table provided next:

Wheel Nut Torque Table

	Mantis Wheel
1st Stage	20-25 ft./lb.
2nd Stage	55-60 ft./lb.
3rd Stage	85-90 ft./lbs



- stage 1* Set your torque wrench to the 1st stage value on the Wheel Nut Torque Table. Begin with the appropriate bolt for your wheel (12 o'clock position for 8 and 6 hole wheels and 2 o'clock position for 5 hole wheels) and apply torque to all wheel nuts following the star pattern as shown in the Wheel Nut Torqueing Sequence illustration shown here.
- stage 2* Increase your torque wrench setting to the 2nd Stage value on the Wheel Nut Torque Table. Begin with the appropriate bolt for your wheel and apply torque to all wheel nuts following the star pattern. Following stage 2, the wheel can support the weight of the trailer and may be lowered off of the jack stands.
- stage 3* Increase your torque wrench setting to Final Torque value on the Wheel Nut Torque Table. Begin with the appropriate bolt for your wheel and apply torque to all wheel nuts following the star pattern.
- follow-up* If the wheel was replaced, check the torque again at every 50 miles for the first 500 miles and prior to each trip thereafter.

If you notice wheel wobbling or hear a rattling sound coming from a wheel, especially at low speeds, a wheel lug may have come loose. This problem is usually caused by improper tightening or by faulty or damaged lug bolt threads. If you have reason to believe a lug nut has come loose, safely stop the vehicle at the side of the road as soon as possible. Put up warning devices. Remove the lug caps and check the tightness of all the lug nuts. If lug bolt threads are damaged or faulty, get professional services help. Do NOT tow the trailer with missing lug nuts or faulty lug bolts.

#### BALANCING, ALIGNMENT AND LUBRICATION

To avoid vibration or shaking of the vehicle when a tire rotates, the tire must be properly balanced. This balance is achieved by positioning weights on the wheel to counterbalance heavy spots on the wheel-and-tire assembly. A wheel alignment adjusts the angles of the wheels so that they are positioned correctly relative to the vehicle's frame. This adjustment maximizes the life of your tires. These adjustments require special equipment and should be performed by a qualified technician.

Wheel bearings should be repacked every 6000 miles or every 6 months. Every time the wheel hub is removed, the wheel bearings must be adjusted. Please refer to manufacturer instructions or schedule maintenance with a qualified technician to repack wheel bearings.

#### TIRE SAFETY CHECKLIST

 (1) check tire pressure regularly (at least once a month and before any extended trip/travelling), including the spare tires, if any... Note: When checking air pressure, be sure that all tires have both the correct and identical pressure before getting on the road; (2) check and torque wheel lug nuts regularly; (3) inspect tires for cuts, slashes, punctures and other irregularities at least on a monthly basis and before every extended trip/travelling; (4) remove any foreign objects (i.e. pieces of glass or metal, etc.) wedged in the tread; (5) confirm all tire valves have valve caps; (6) do not overload your tow vehicle or trailer; (7) slow down when having to go over a pothole or other object in the road, and avoid running over curbs and other foreign objects in the road and when parking if you can safely do so; (8) Replace tires when tread depth approaches and/or reaches 1/16 of an inch; and (9) have a qualified technician perform tire service, maintenance and adjustments as needed.

**MANTIS DESCRIPTION**

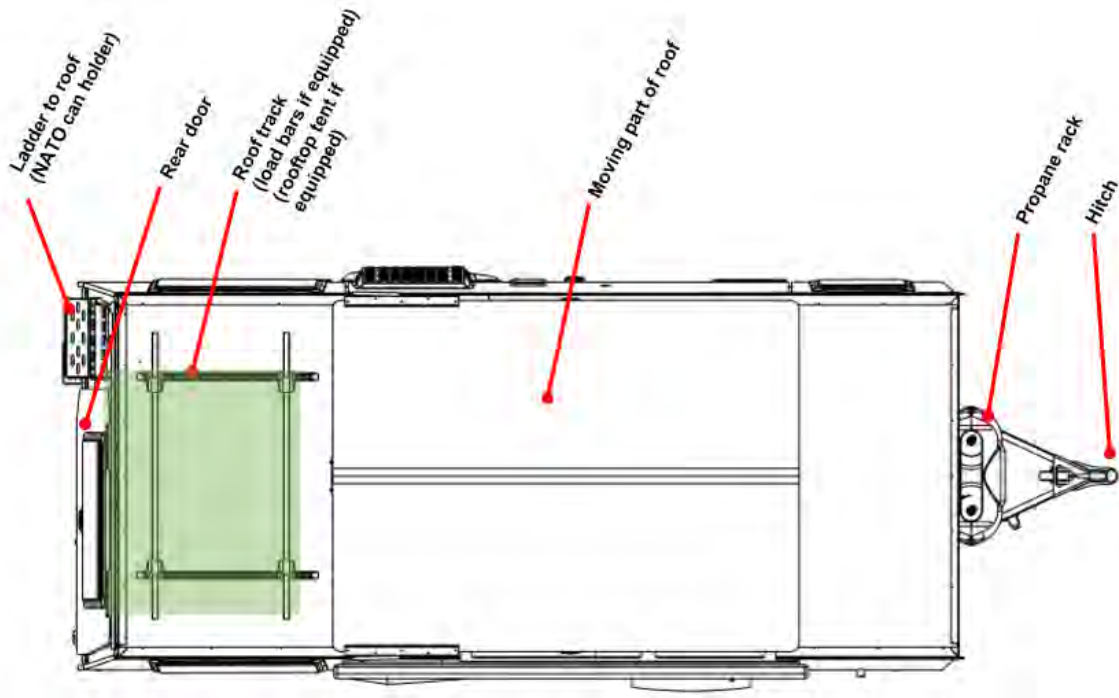

**ROOF PLAN**

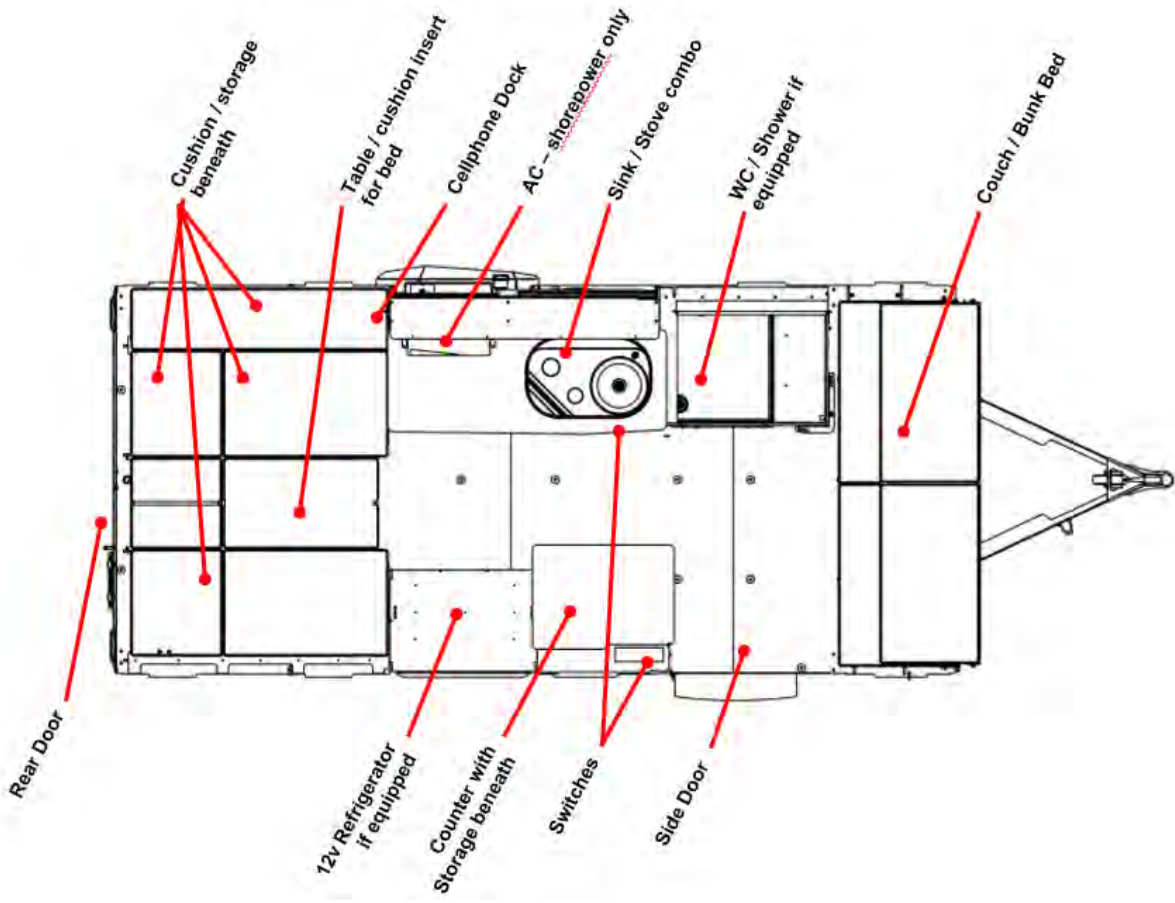

**FLOOR PLAN**

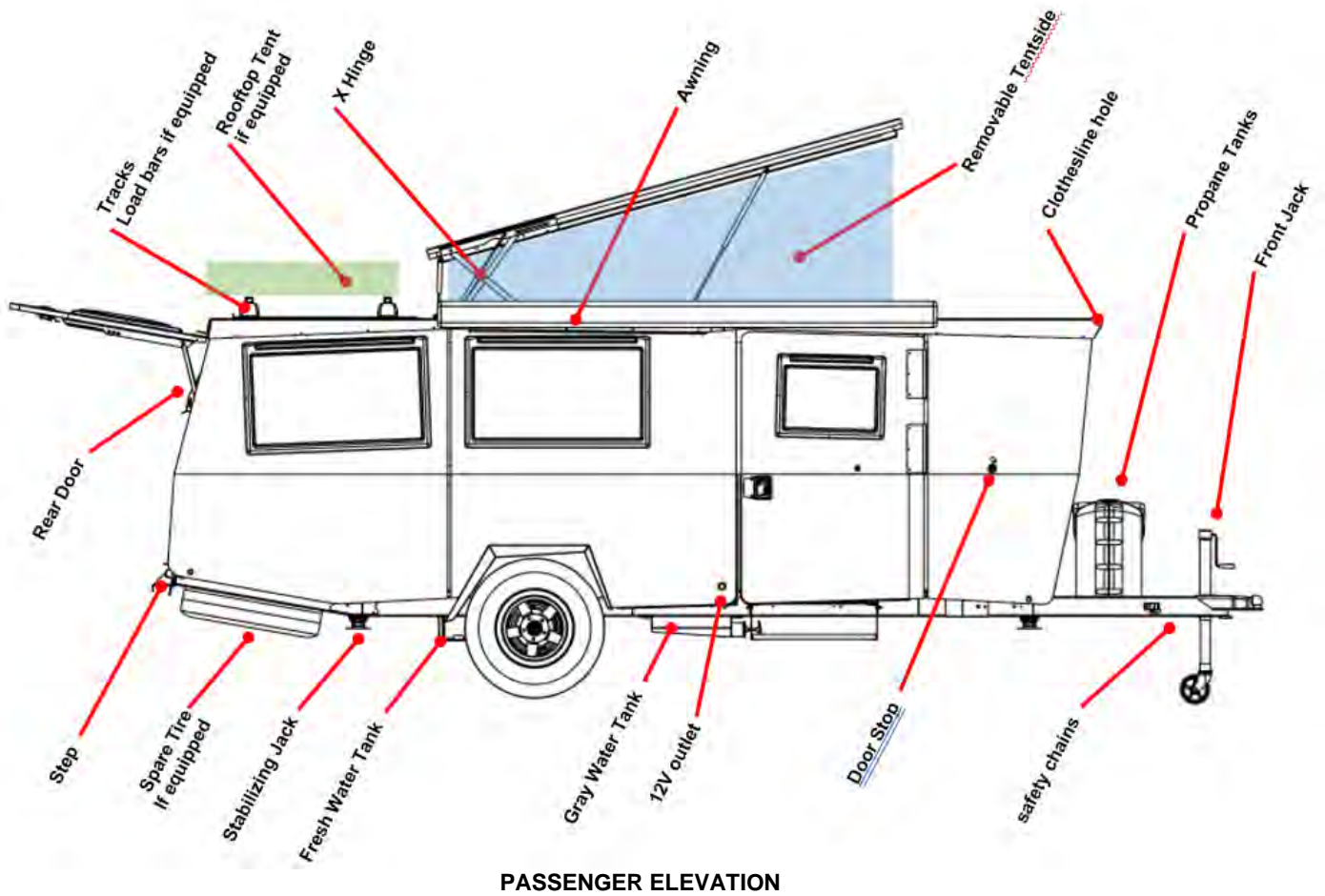
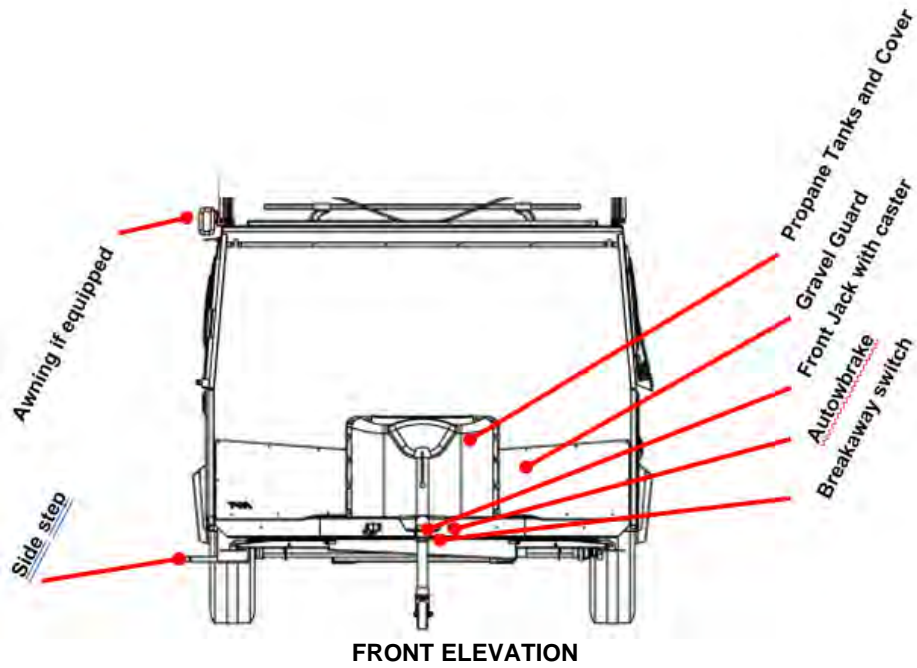

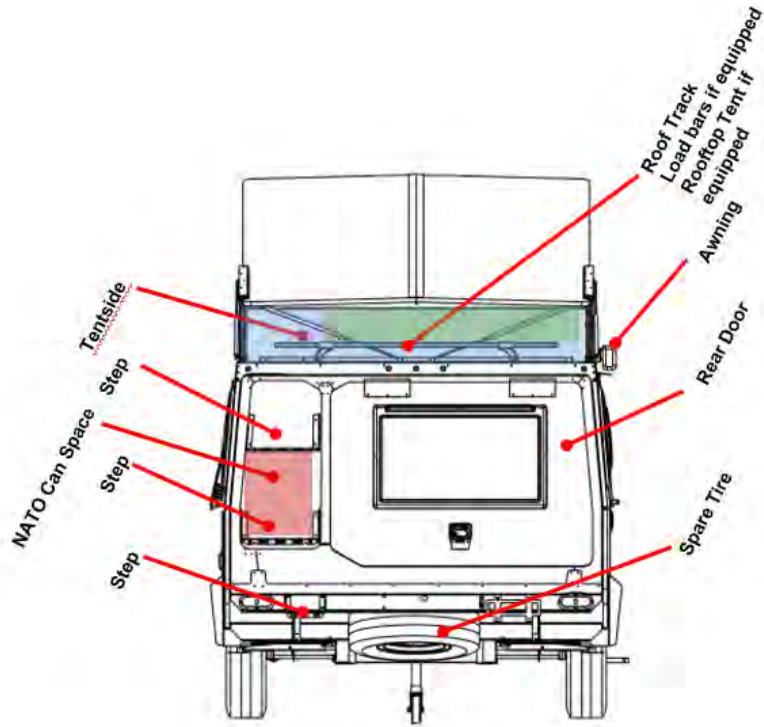

**REAR ELEVATION**

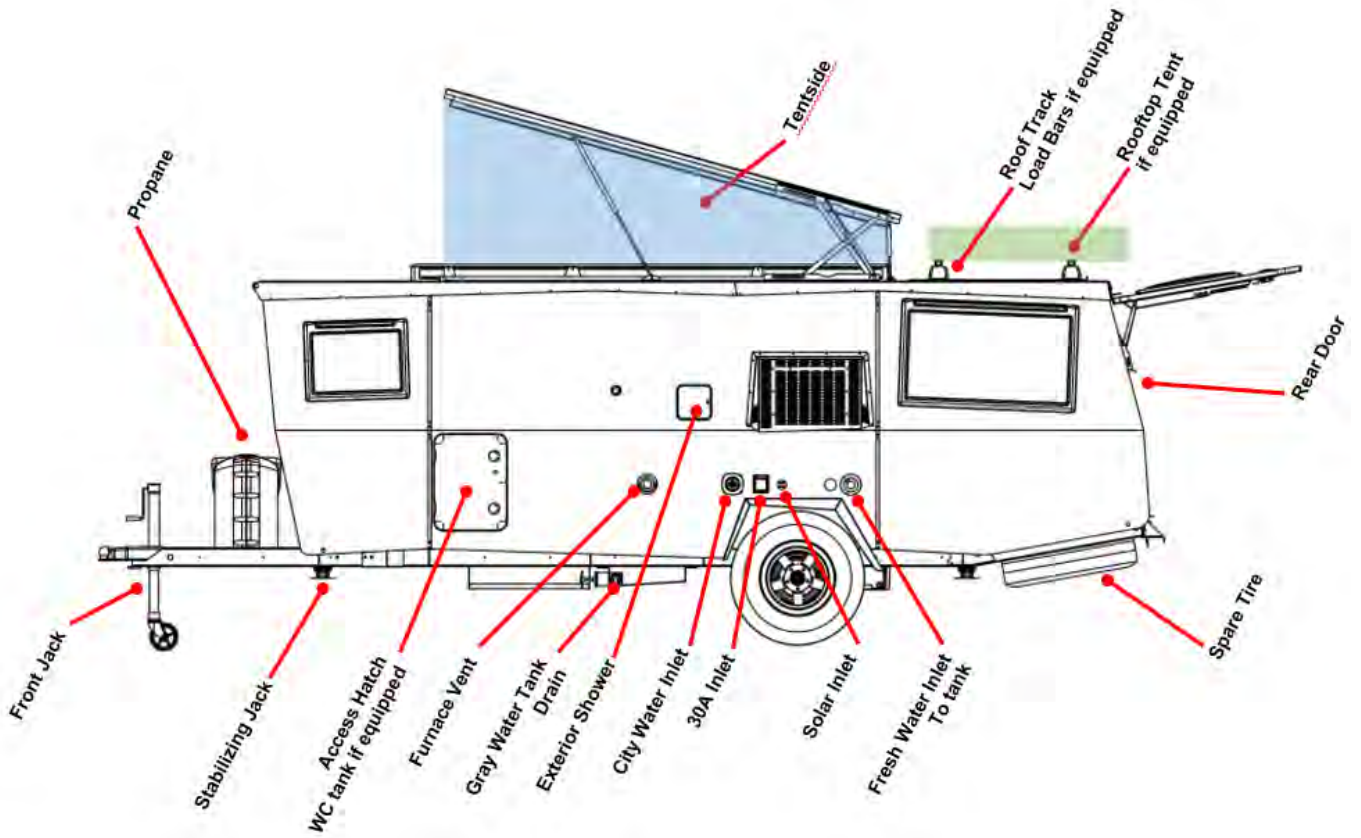

**DRIVER ELEVATION**



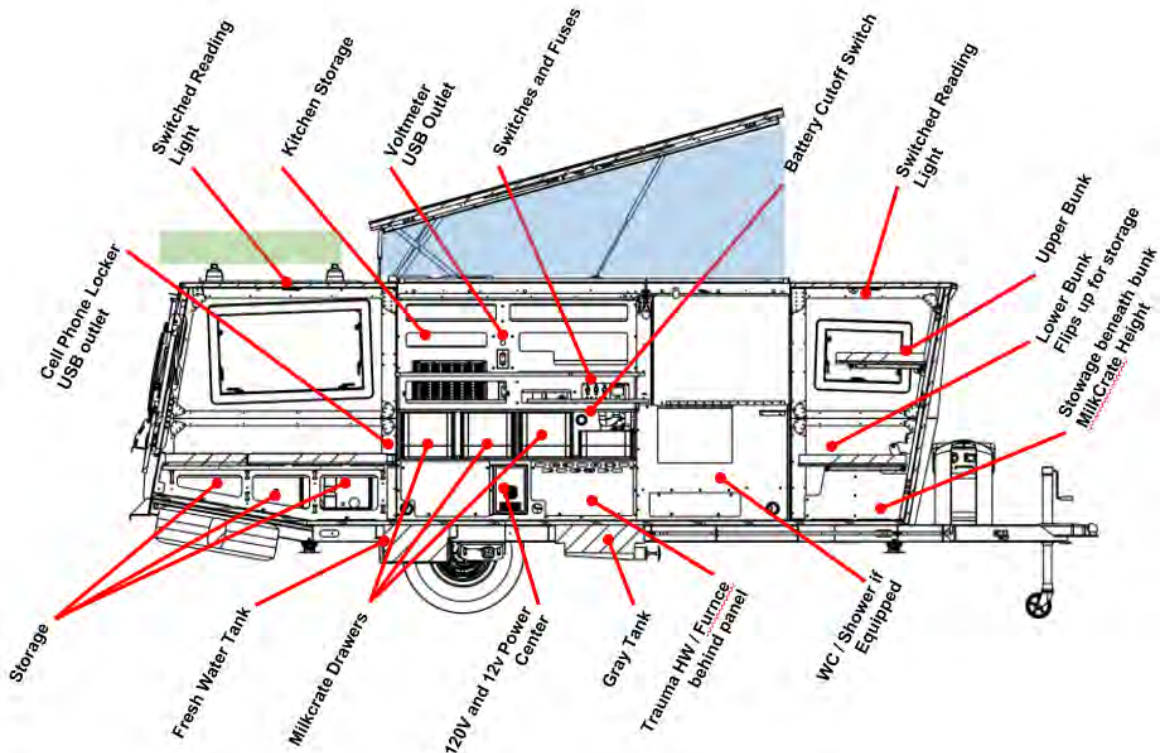

SECTION TOWARD DRIVER SIDE

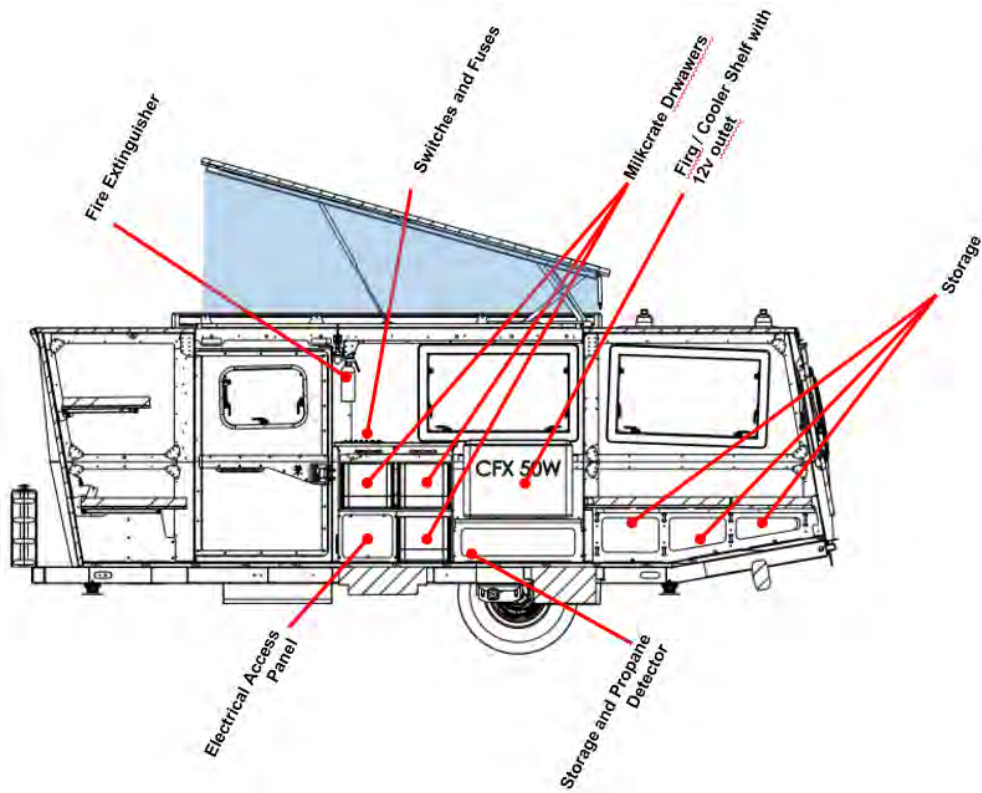

**SECTION TOWARD PASSENGER SIDE**

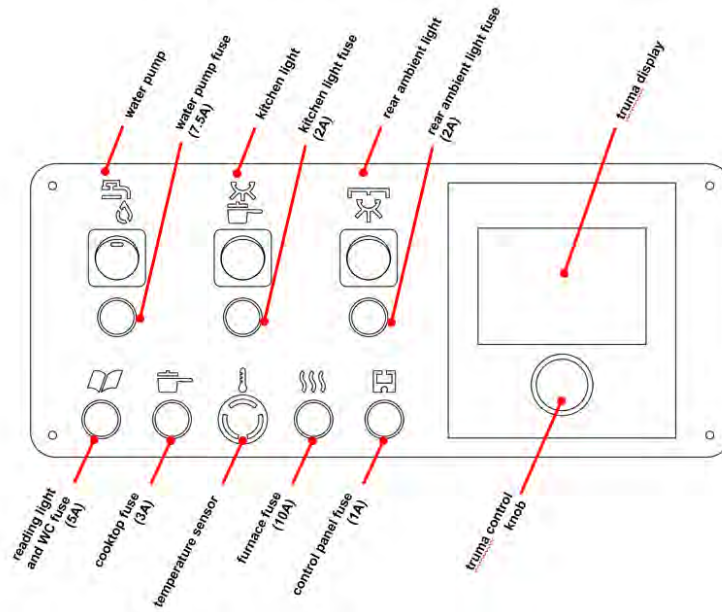

**FUSE AND SWITCH PLATE AT KITCHEN**

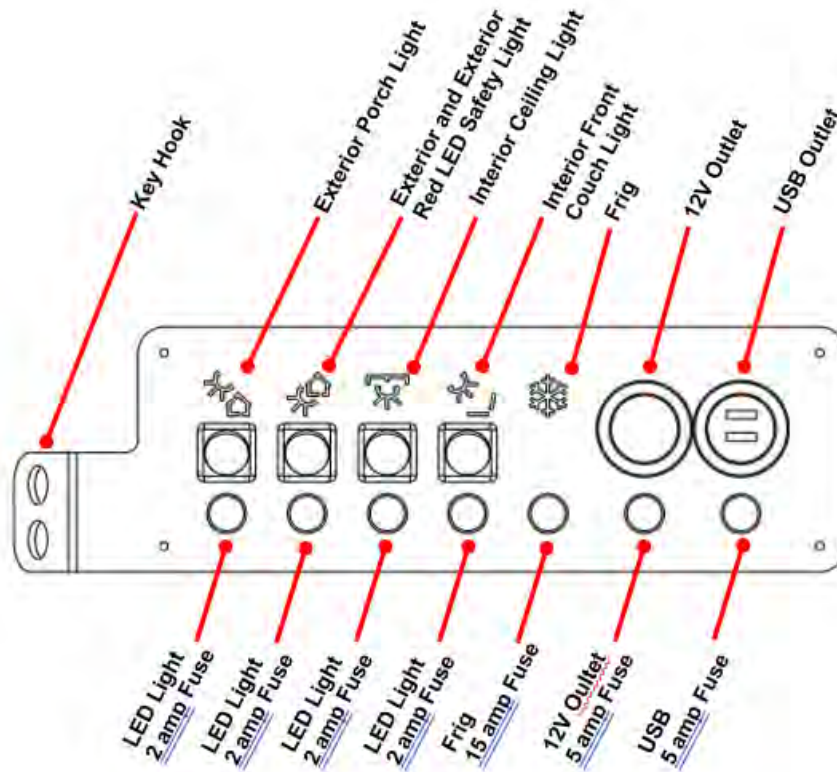

**FUSE AND SWITCH PLATE AT SIDE DOOR**

**PLUMBING**

**PROPANE KITCHEN PLUMBING**

MP2-11-1000-R0

	1/2" LLDPE Tubing (SP-3714)
	2mm LLDPE Tubing (SP-3715)
	12mm LLDPE Tubing (SP-4311)
	Shower Head (SP-5116)
	Stainless Steel Combo (SP-7254)
	Elbow, 1/2" (SP-6004)
	1/2" Tee/Female to 1/2" Tube (SP-4003)
	Elbow, 90\", 12mm (SP-4114)
	12mm Pop-Off/Drain (SP-4122)
	Shower (SP-5116)
	Faucet (SP-4123)
	Water Heater Furnace Combo (SP-4124)
	Elbow, 12mm (SP-4114)
	1/2" BSP to 1/2" Tube (SP-4112)
	Tap, 12mm (SP-4114)
	Elbow, Red, 12mm (SP-4114)
	Pressure Reducer (SP-4124)
	Filter (SP-4116)
	Water Pump (SP-4124)
	Set Shower (SP-5116)
	Water Heater Pressure Reducing (SP-4127)

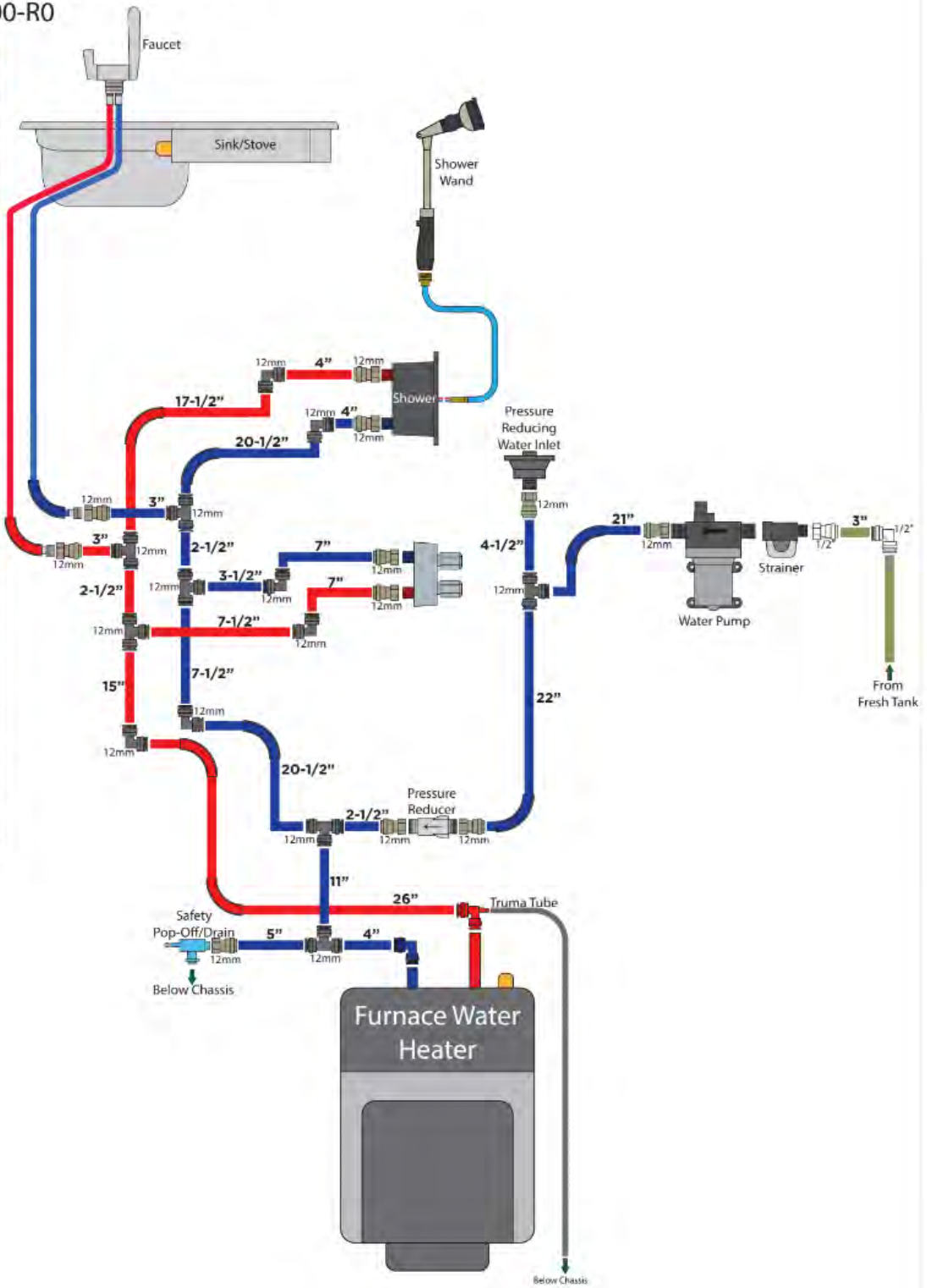



# PROPANE KITCHEN DRAIN SYSTEM

## M-11-1100-R0

1-1/2" Schedule 40 PVC	
Stove/Sink Combo (LP-P24)	
Shower Pan (MA-R01)	
1-1/2" Tail-piece (SP-D27)	
Slip Flange (SP-D02)	
Faucet (LP-P22)	
1-1/2" Manifold Connector (SP-D13)	
Extension Tube, 12" (SP-D25)	
Extension Tube, 6" (SP-D23)	
Plumber's Putty	
Water Heater Furnace Combo (LP-P25)	
1-1/2" Wall Bend, 90° (SP-D24)	
1-1/2" Sanitary Tee (SP-D15)	
1-1/2" PVC Adapter (SP-D26)	
1-1/2" P-Trap Kit (SP-D22)	
Sink Strainer (SP-H08)	
Long Radius Tee (SP-D09)	
PVC Long Elbow, 1-1/2" (SP-D38)	
PVC Short Elbow, 1-1/2" (SP-D37)	

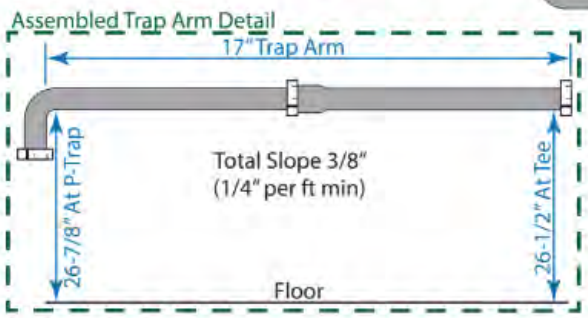
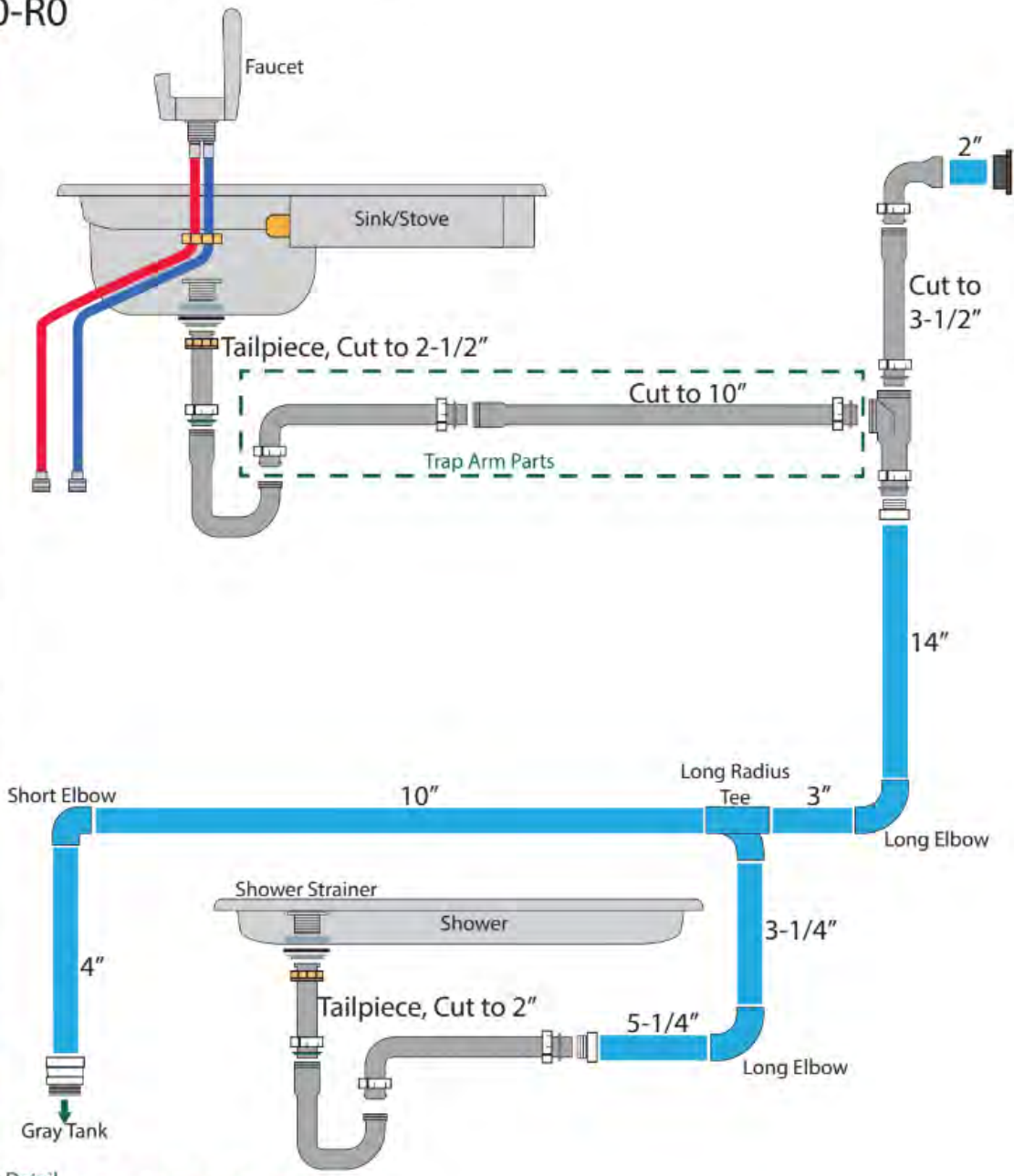

# CHASSIS PLUMBING M-11-2000-RO

1-1/2" ABS (SP-D29)			
Water Fill Hose 1-1/4" (LN-T62)			
1/2" LLDPE Tube (LN-TT1)			
1/2" Flex Tube (LN-T12)			
Slip-90 (SP-R04)		Potable Water Inlet (SP-G11)	
1/2" Male to Slip (SP-R01)		LWHT Drain Valve (SP-D01)	
Shut off Valve (SP-D03)		Slip Flange (SP-D02)	
Barb Adaptor 1/2" NPT to 1/2" Tube (SP-P01)		1-1/2" Male ABS Adaptor (SP-D26)	
#4 Clamp (SP-I41)		1-1/2" Cap (SP-I21)	
#20 Clamp (SP-I01.2)		Zip Tie, Mountable (SP-I31.5)	
#28 Clamp (SP-I01.3)		Gray Tank Hanger	
Fresh Tank Hanger		Flow Bend Clip (SP-R18)	
GRAY TANK			
FRESH TANK			

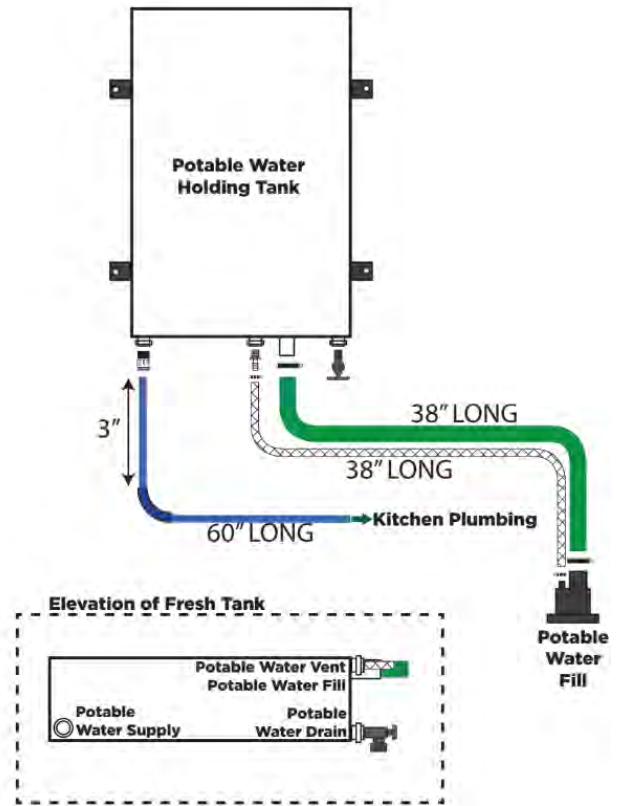
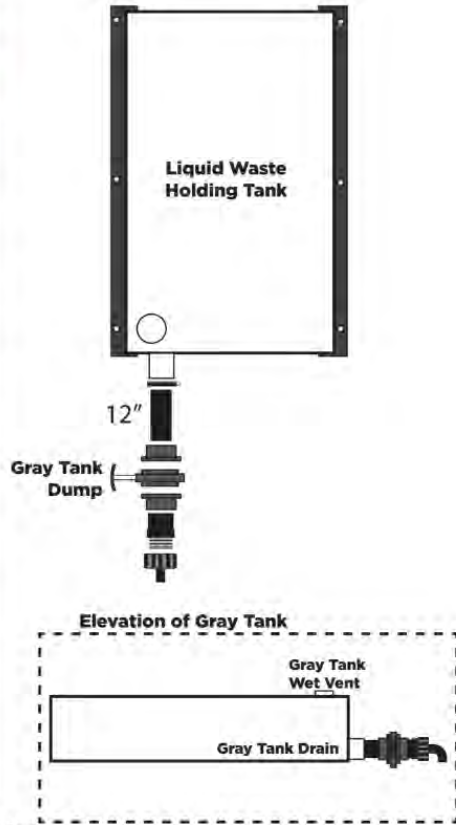

**Note:**  
1. All drain lines sloped 1/8" per foot.

*overview* .... your trailer's fresh water system is a vital part of your traveling life while on the road. Your MANTIS is equipped with a dual supply water system: (1) the demand fresh water system operates from the trailer's supply tank and water pump; and (2) the "city water" hookup allows you to connect to a pressurized external water system at a campground.

Fresh water is stored in a plastic tank located below the floor of the trailer. The tank is vented to allow proper and complete filling. The drain valve allows you to drain the tank. Always drain the tank before storing the trailer for long periods. When the trailer is in continuous use for an extended period (generally over a month). Drain and clean the tank monthly. The entire fresh water system should be sanitized before the first use, after a reasonable period of nonuse, and when the system is contaminated. Please also see below for more information on sanitation and routine tank maintenance.

The easiest way to keep the tank full of clean water is to use (1) a dedicated clean water hose and (2) a filter system inline with your hose . You will need to purchase these two (2) items separately.



Note regarding your fresh water hose: *Never use the hose for anything except filling the freshwater tank or connecting to city water, and always store it independently of other hoses and plumbing supplies. Also remember that nothing should pass through the fresh water hose unless it first passes through a filter inline with the hose.*

Non-toxic, FDA-approved drinking water hoses are inexpensive and work well. They are typically white in color with a light blue stripe, which helps to identify the hose and serves as a reminder to keep it separate from other hoses or hardware, especially those used for waste drainage. You may consider using a special FDA-approved hose as many common garden hoses are made of reground rubber. As clean water hoses age and compounds break down, you may notice taste and odor-related impurities in your fresh water supply. To help counteract this process, be sure to screw the two (2) ends of the fresh water hose together following each use. This also prevents dirt or other matter from entering the hose.

Do NOT fill the potable water tank too quickly as air can be trapped in the tank if you do. Fill the tank slowly, allowing the air inside to escape through the inlet vent and reducing the possibility of water gushes and/or spray back.

#### IMPORTANT PLUMBING CONSIDERATIONS AND COMPONENTS

*water pressure, pressure regulator (not included) and check valve* .... The recommended pressure for your plumbing system is <55 psi. Water pressure frequently varies depending on your location and water pressure exceeding 55 psi can damage your plumbing system. Installed as part of your Mantis's fresh water inlet is an integrated water pressure regulator to use when connecting to a city/campground water supply.

City or campground water systems may operate at pressures that can damage the water system in your trailer and/or cause the water pump to fail. **WARNING: If water pressure at your site EXCEEDS 125 psi, you will have exceeded the capacity of your water pressure regulator.**

*More information about your water pump* ... your water pump is generally referred to as a "demand" pump, operating when it detects a pressure drop in the water lines. This is similar to, for example, the pressure being restored after a sink faucet is turned off. If the indicator light is ON at the kitchen switch panel, the water pump is operational. Many campers only turn the

pump on when using the plumbing - turning it off after usage. The pump vibrates and makes a humming noise when in operation.

*prepping fresh water tank for use ...* (1) fill the fresh water tank as instructed; (2) turn on the water pump switch; (3) Turn on the sink faucets both hot and cold, allowing time for the water heater to fill ... Note: be sure that your faucet is set to engage hot water flow. (4) turn off each sink faucet as the water flow becomes steady and free of air (stops sputtering, and a solid stream of water flows from the faucet );(5) allow the water pump time to stop running ... the water pump should stop running approximately 5 minutes after the sink faucets are turned off; and (6) the system is now ready for use.

*water heater ...*

your Mantis is equipped with the TRUMA system – combined propane furnace and HW heater please refer to the TRUMA manual for complete instructions and maintenance procedures (<https://www.truma.com/web/downloadcenter/files/truma-heating-combi-operating-us-en.pdf>).

The controls for the TRUMA are electric and are located in the kitchen switch panel.

Here are the “quick start” instructions for using your TRUMA:

**Truma Combi® Quick Reference**

**CP Plus Functions**

- Adjust room temperature - Range: 40-86°F (5-30°C)
- Select energy mode
  - a) LP gas
  - b) MIX 1\* - Electricity 850W + Gas
  - c) MIX 2\* - Electricity 1700W + Gas
  - d) EL\* - Electricity 850W
  - e) EL\* - Electricity 1700W
- \*Truma Combi eco plus and comfort plus
- Adjust water temperature
  - a) **boiler** – Hot water generator is on. Icon flashes until desired temperature is reached.
  - b) **eco** – Water temperature is 104°F (40° C)
  - c) **hot** – Water temperature is 140°F (60° C)
  - d) **boost** – Boiler content is heated quickly (boiler priority) for up to 40 minutes. The water temperature is then kept at the higher level (about 144° F (62° C) for two subsequent heating cycles. When the water temperature is reached, the room is heated again.

**Truma Combi® Quick Reference**

**CP Plus Functions – Cont.**

- Set clock to current time
- Set time switch  
Set a start time and end time for room temperature, water temperature, energy mode and fan speed set points.
- Settings
  - Index** - Show version number of connected device
  - Bright** - Adjust backlighting
  - Lang** - Adjust language
  - 12-24h** - 12/24 hour mode
  - Temp** – °F or °C
  - Offset** – Calibrate temp offset
  - Pr set** – Factory reset
- Select fan speed
  - OFF** – Fan is switched off (If furnace mode OFF)
  - a) **VENT** - Circulating air (If furnace mode OFF)
  - b) **ECO** - Low fan speed
  - c) **HIGH** – High fan speed
  - d) **BOOST** – Fast room heating. Available if the difference between the selected and current room temperature is >18° F (10° C)



TRUMA location



cover plate removed

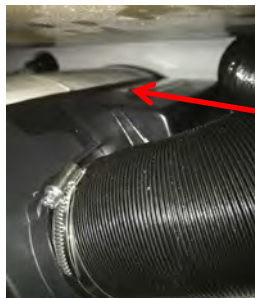

ON / OFF switch on top right of unit

switch location (located on flat portion of right side top). The switch is ON, when the front (closest to inside of trailer) of the switch is pushed down.

#### MAINTENANCE AND SANITATION

*fresh water tank and system (overview) ...* potable water (suitable for consumption) does NOT stay potable for a long period of time. Thus, be sure to exercise caution when deciding whether to use your stored water for drinking. We recommend that you



be conservative in making this determination, and make every reasonable effort to use your stored water for washing, rinsing, and cleaning only. Regardless, you must diligently maintain your water system, emptying and replacing your fresh water periodically. We also recommend that you separately purchase and install a water purification system to attach to the sink faucet or at the city water inlet hose, especially if you plan on consuming your stored water. See below discussion regarding sanitation.

*filling the freshwater tank ...*

(1) prepare the inlet on the rear driver's side panel of the Mantis; (2) Connect one end of a potable water transfer hose to a water supply, turn on the water supply and let the water run until it is clean and clear; (3) Turn off the water supply, and place the other end of the transfer hose into the fresh water inlet located on the side of the trailer; (4) Turn on the water supply and fill the tank until tank is full. Avoid overflowing tank as this can fill the vent tube with water. If the vent tube gets full of water the tank can become difficult to fill. (5) Remove and store the hose; and (6) slide cap back into the fresh water tank inlet.

*city water systems (overview) ...* city water systems are connected using your potable water hose at a hookup located on the exterior wall of the trailer. Campground water systems have varying pressures, some of which can be too high for your trailer's plumbing system. A pressure regulator can be used to reduce the water pressure flowing to the trailer. Please also see discussion of pressure regulators below.

Always connect to a quality water supply. A water supply delivered as potable is more likely to have been properly tested. If camping at a site with a water well, look for labels and other markings that reflect testing and approval dates. If you are unable to determine this information, be on guard and use caution before using the water supply provided at the site.

*city water (connecting) ...* (1) Set the water pump switch located on interior panel to OFF; (2) get your fresh water hose, placing one end at the hookup located on the exterior wall of the trailer (far left of three total inlets); (3) Turn on the site water supply, allowing the water to flow until it is clean and clear; (4) Turn off the site supply valve and connect the other end of the fresh water hose to the site water supply; and (5) Turn on the site supply valve.

**IMPORTANT PRECAUTIONS** Whenever you leave the trailer for more than 10-15 minutes, be sure to turn off the water pump (see kitchen switch panel and accompanying indicator light) and/or shut off the city water supply. A sudden, unexpected leak in the water system will allow the water system to run freely and flood the trailer.

Be sure to turn off the water pump while travelling/towing. If not, a faucet may open while travelling, causing fresh water to escape. If you leave the sink drain plugged, the sink will overflow causing the interior of the trailer to be flooded. Always set the water pump to OFF with an empty fresh water tank. Otherwise, it may destroy the pump and cause a blown circuit.

*to empty the fresh water tank ....* The valve for the fresh water tank is located beneath the trailer directly connected to the bottom of the white tank. It is white in color and the valve is white. Turn the valve to open and close when it has finished draining.

*wastewater system ...* The Mantis has a GREY water holding tank (for sink drainage). It does NOT contain a BLACK water holding tank (for septic waste). Grey waste water is contained in a "grey water" holding tank. NOTE: Rules regarding proper waste disposal vary, sometimes greatly, from site to site. Please be sure to educate yourself on the waste disposal rules of your particular site / location and follow them.

*to empty your grey tank....* The grey tank valve is indicated by a sticker on the exterior of the trailer, located on the driver's side panel in front of the wheel. Pull the T-handle to open the valve. Close when grey tank is empty.



*Hand shower / hose ...* your Mantis may have two showers! The exterior shower is located on the driver's side about midway behind a small square black door. Behind this is a hot and cold water valve and a Quick Disconnect (QD) valve to insert the blue coiled hose of the shower wand. The brass end on the hose simply pushes into the QD receptacle – a click will indicate it is secure.

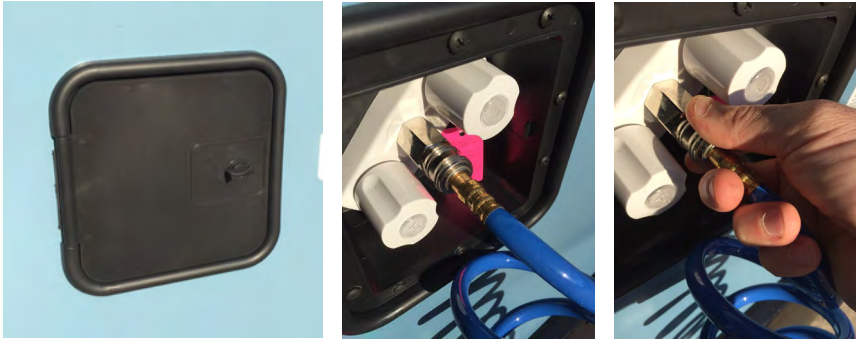

To remove the hose after use push the nickel ring in (towards trailer) and the brass end should pop out. Hose off your head, your feet, your dog, etc. Use an exterior privacy enclosure for a full on shower if you like.

That pink tag in the picture has instructions for winterizing. They are repeated here:

*“This faucet contains backflow prevention. Faucet must be drained for storage or if freezing weather is expected. To drain: 1. Disconnect water supply to the vehicle. 2. Open both Hot and Cold valves. 3. Insert flexible spout or coil hose with spray nozzle removed into quick disconnect. 4. Hold open end of hose or spout near ground and drain system. 5. Preferred method: open faucet as above and blow out entire water system with pressurized air or pump entire system with RV fresh water safe anti-freeze.”*

*Interior shower ... your Mantis has a combo WC / shower option! To take a shower or use the WC:*

1. flip up the countertop and secure with the latch to prevent it crashing down.
2. remove the included privacy curtain from the snapped-on bag that hides the bathroom floor.
3. attach the four carabiners to the waiting bungees / hooks on the ceiling, snap the bottom four corners to form your cubicle!
4. tie or Velcro the flaps closed.
5. bathe



*cassette toilet ... your Mantis has a built-in cassette toilet. Utilizing a cassette toilet rather than a Black water tanks gives you the freedom to empty into an RV dump station OR a pit toilet OR your home toilet with equal ease. Refer to and follow the manual associated with the c toilet (<http://www.thetford.com/wp-content/uploads/95/03/C402C-and-C403L-Cassette-Owners-Manual.pdf>).*



*Routine sanitation process . . .* Be sure to periodically (between trips and/or every few months) conduct routine maintenance on your water system to keep it in good working order. There are many ways to do this and many supporting products from the RV industry.

*Empty the water heater between uses by:*

- a. draining the fresh water tank.*
- b. turning on the water pump and running the sink faucet on HOT til there is sputtering.*

*Empty the water heater for storage **or for freezing temperatures by:***

- a. draining the fresh water tank.*
- b. turning on the water pump and running the sink faucet on HOT til there is sputtering.*
- c. opening drain valve on TRUMA*

For more details refer to the TRUMA manual. As an extra precaution and to avoid damage to your system we reprint the winterizing page from the manual here:



## Draining the water container

**NOTICE** Damage to the Truma Combi furnace caused by freezing!

- The Truma Combi furnace does not feature a frost-protection function. The water container must be drained if the recreational vehicle (RV) will not be used whenever there is a risk of frost.

**No warranty claims for frost damage.**

**i** To make sure that all water drains properly from the water container, place a big enough vessel underneath the drainage socket of the drain valve (> 2.64 gallons (10 liters)).

1. Use the main switch or pump switch to switch off the power to the water-pump assembly.
2. Turn off or disconnect the city water connection, if present.
3. Open all water release points, e.g. cold and hot water faucets, showers, toilets.
4. Open the drain valve (refer to "Opening the drain valve" on page 10).

The water container will drain via the drainage socket of the drain valve.

## Winterizing

**NOTICE** Severe damage to the plumbing components and the Truma Combi furnace! Damage due to freezing or an unsuitable winterizing fluid is not covered by warranty.

- Follow the recommendations below if the Truma Combi furnace will be stored under freezing conditions or for an extended period of time.
- Winterize the Truma Combi furnace at the start of the winter season or before traveling to a location where freezing conditions are likely.

For winterizing, drain the Truma Combi furnace, refer to "Draining the water container" on page 13.

After draining the water, the Truma Combi furnace is protected against freezing conditions.

## Optional: Winterizing the RV with a winterizing fluid

**i** Winterizing the RV with a winterizing fluid is only possible with an installed bypass kit (not in scope of supply), refer to the RV manual.

1. Drain the water container (refer to "Draining the water container" on page 13).
2. Turn the valves of the bypass kit according to the supplier's or RV manufacturer's guidelines.
3. Flush the water system with a suitable winterizing fluid according to the supplier's or RV manufacturer's guidelines.

**i** Before using the Truma Combi furnace again in hot water mode, remove the winterizing fluid and flush the water system with potable water.

## Winter operation

To operate the Truma Combi furnace in potentially freezing conditions, the following requirements must be ensured:

- There must be sufficient LP gas (propane; fuel inlet pressure 11 - 13 in. wc (27.4 - 32.4 mbar)) in the tank.
- In addition, the Truma Combi eco plus and the Truma Combi comfort plus models require a supply voltage of 120 V if they are to be operated in electric or mixed mode.
- For hot water operation, the water container must be filled (refer to "Filling the water container" on page 11). You must leave the furnace powered ON whenever freezing might occur.

Winter operation will not protect the RV's entire plumbing system. The RV must be designed for freezing conditions.

## ELECTRICAL SYSTEM

Your Mantis trailer's electrical system is a primarily a 12 Volt Direct Current (DC) system and has 120V AC outlets that operate only when attached to shore power. This is explained as follows:

### 12V DC OVERVIEW

Your trailer 12 Volt system is powered by a 12V battery or batteries (see "Battery" section). All installed appliances, aside from air conditioning, operate fully with 12V power. Fuses for 12V circuits are located either below the switch itself or in behind the

plastic panel of the WFCO Power Center at the bottom of your kitchen cabinet.

*7-pin connector* use your 7-pin connector plug to connect your tow vehicle and trailer electrical systems. This cord is located at the front of your trailer and plugs into a receptacle provided in your tow vehicle's hitch package. In addition to charging your trailer battery while driving, this connection powers your trailer lights and electric brakes (your Mantis has a wireless proportional brake controller installed). **BE SURE TO PLUG THE 7 PIN CONNECTOR WITH THE PROPER HOLES AT TOP AND BOTTOM. FAILURE TO DO SO MAY DAMAGE YOUR TRAILER WIRING AND ELECTRIC BRAKE SYSTEM.**

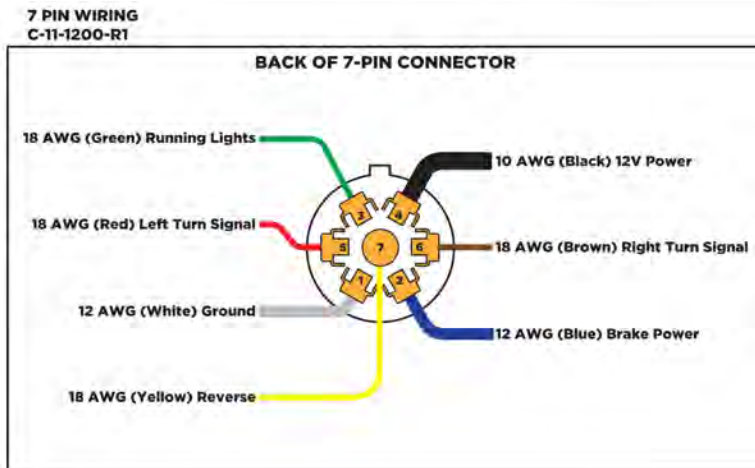

**We recommend disconnecting the 7 pin connector from the tow vehicle when camping!**

When hitching and unhitching, be sure to move the 7-pin connector cord so it does not get damaged by, for example, the hitch and/or pin box. Do not allow the cord to drag on the ground and cover with a rag or soft cloth when not in use. Keep the connector clean and dry, and follow manufacturer instructions for cleaning if necessary. See also "Hitching " section for further discussion regarding your 7-pin connector.

Your air conditioning unit will operate only on external 120V power from a home, campground or a generator. There is a dedicated 120V GFCI outlet located close to the air conditioner's location. *Important Note: you must refer to the manuals and other instructions of any and all appliances, add-ons and/or accessories regarding their respective electrical requirements.*

*120V circuit breakers* ... 120V circuit breakers are located inside your WFCO Power Center, which is located behind a plastic panel at the base of your kitchen cabinet. They control the circuit between the 120v inlet and the 12v power provided in the trailer. If your circuits trip because of overload, reduce the load and reset the breaker.

**PROPANE** - See wiring diagrams below.

**ELECTRIC**

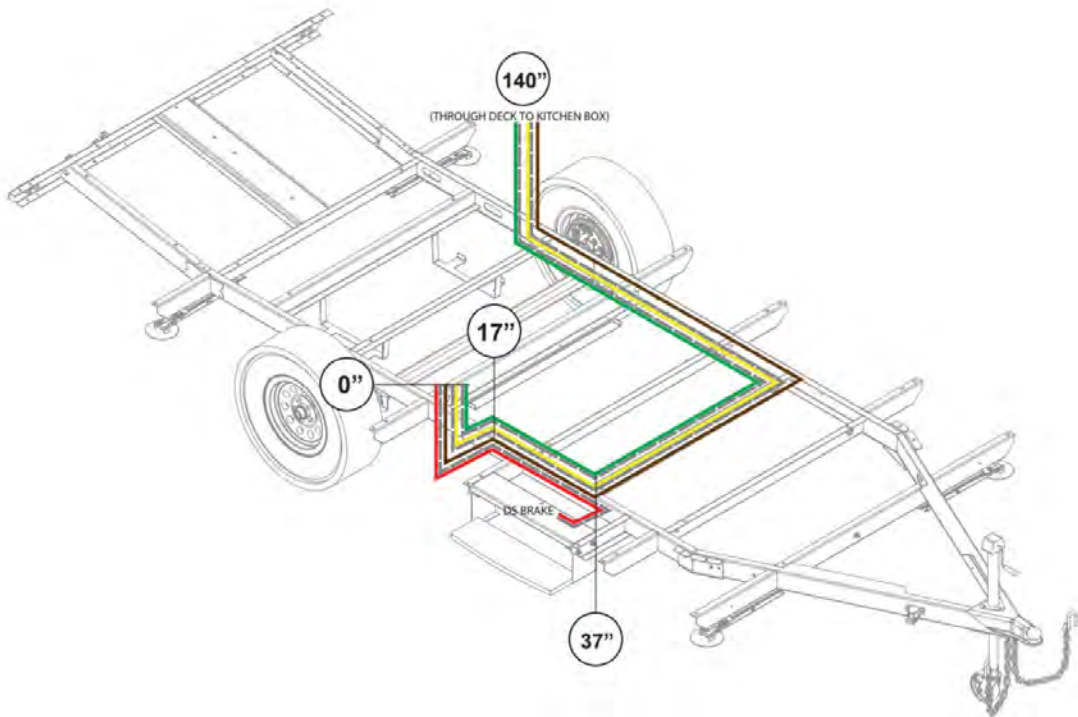
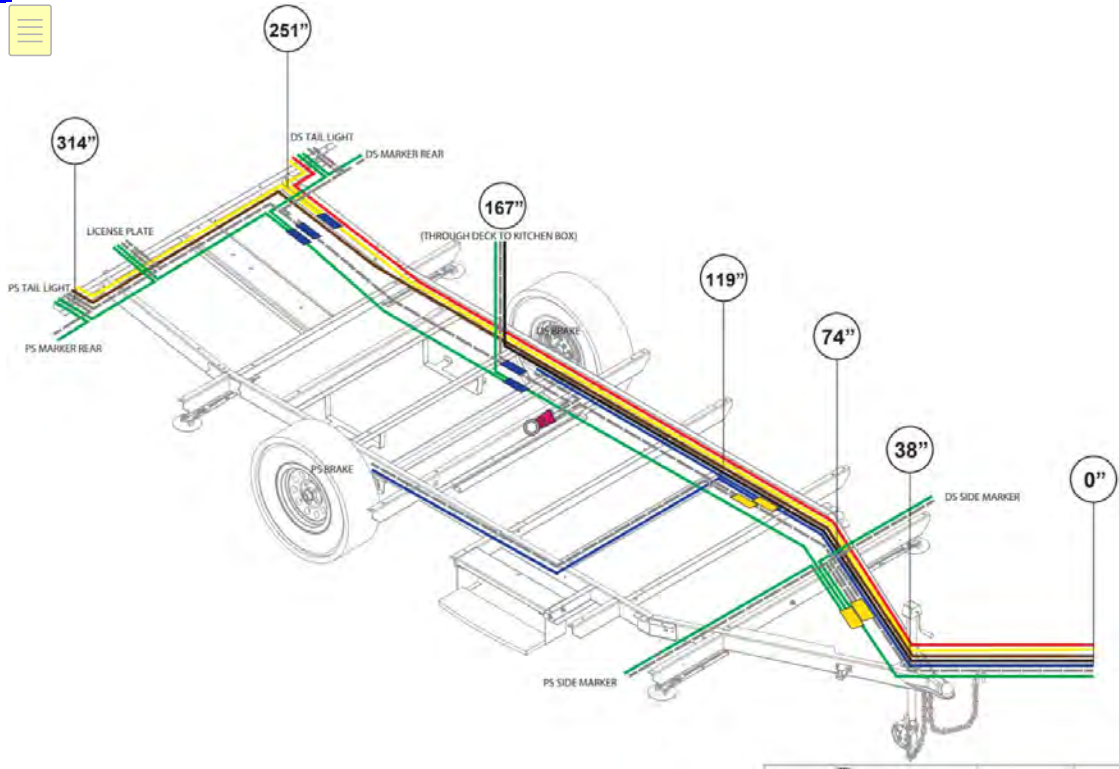

**CHASSIS OVERVIEW**



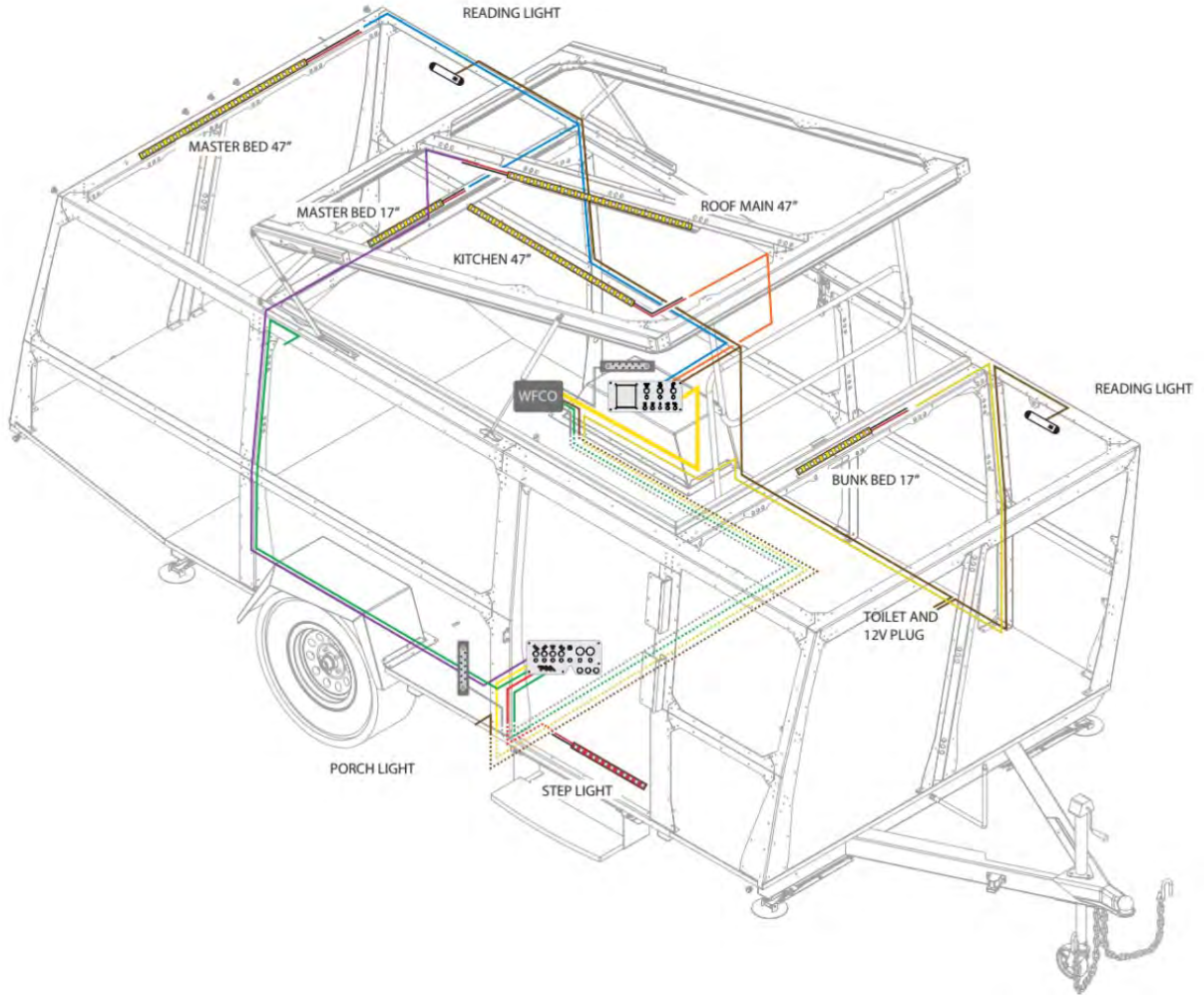

**CABIN OVERVIEW**

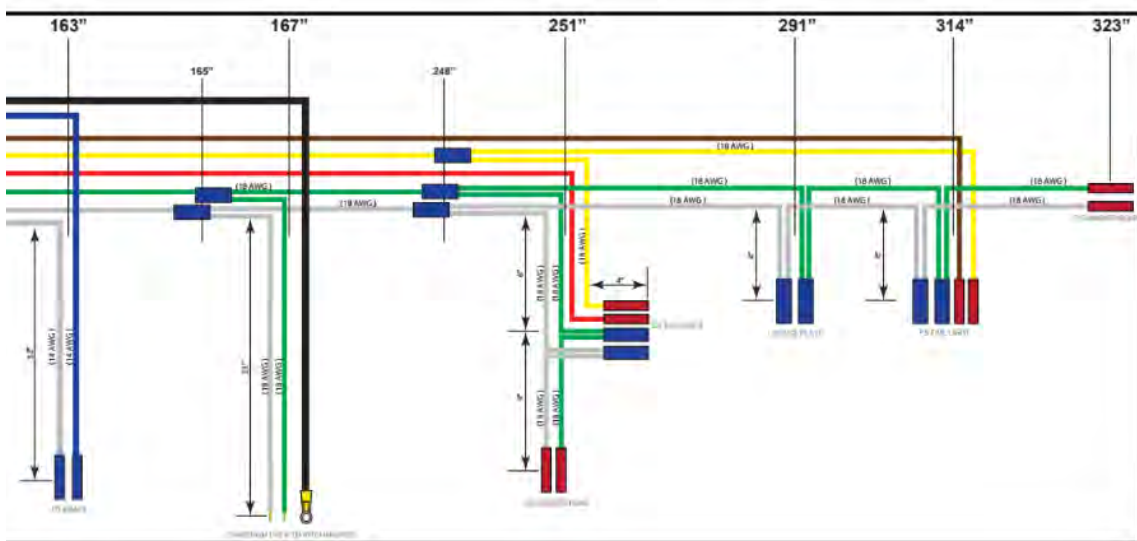
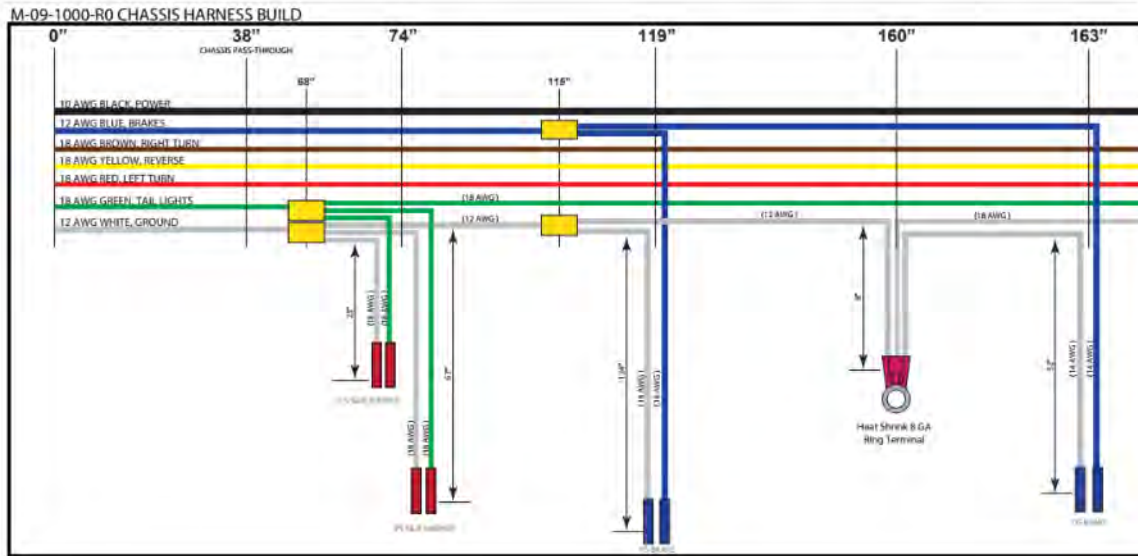

**CHASSIS HARNESS**

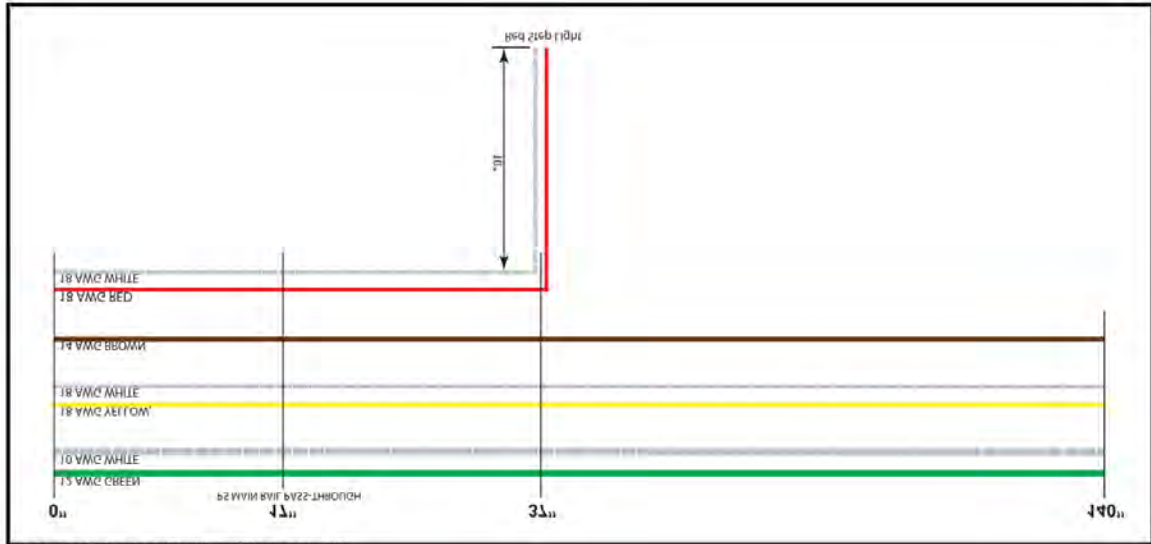

**CHASSIS SECONDARY**

**M-09-1300-R0 REAR LIGHT BAR**

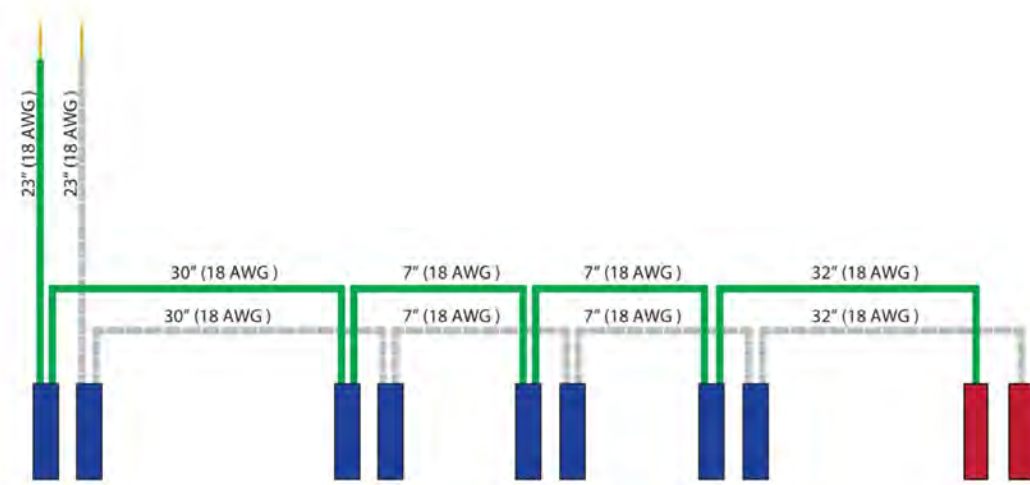

**RUNNING LIGHTS AT REAR**

**WFCO BOX ELECTRICAL**  
**M-09-2000-R0**

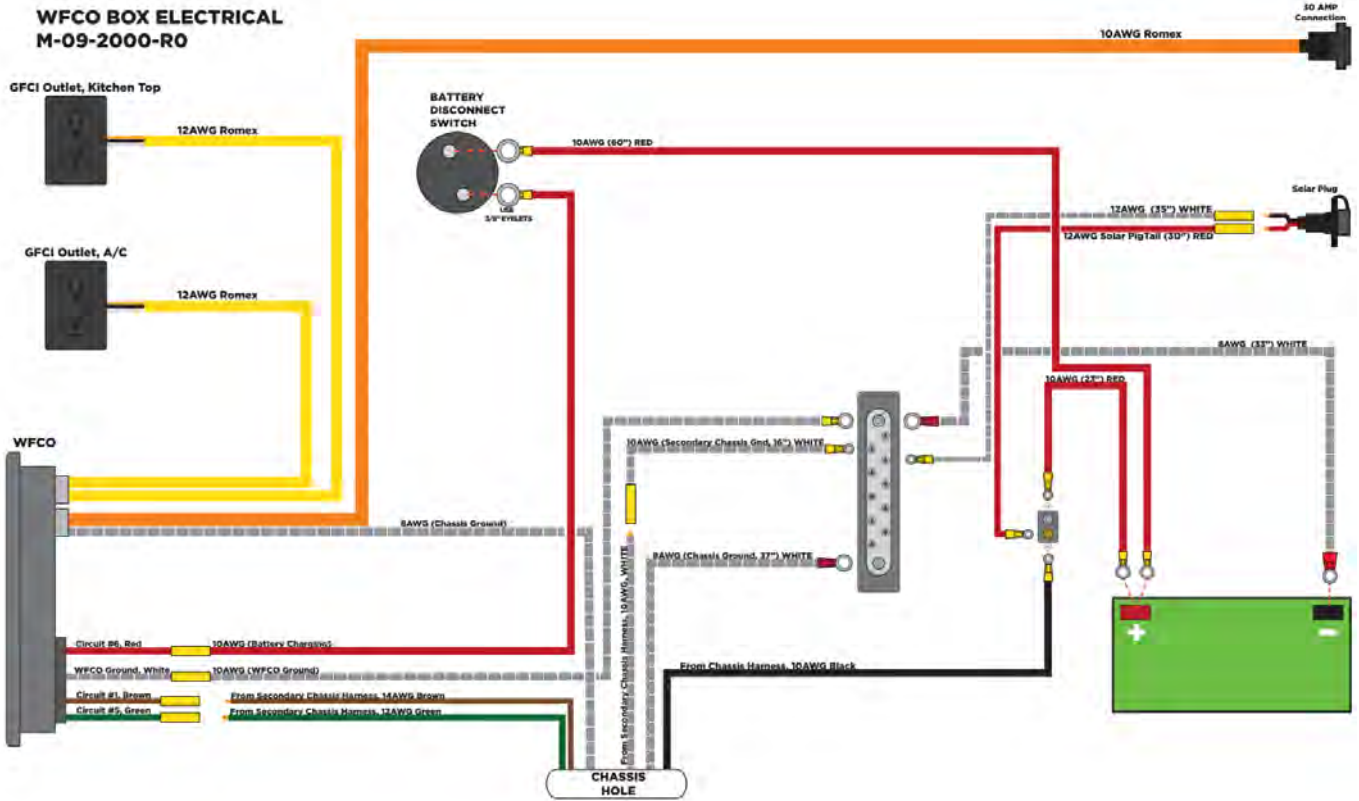

**M-09-2100-R0 WFCO**

**GFCI Outlet, Kitchen Top**

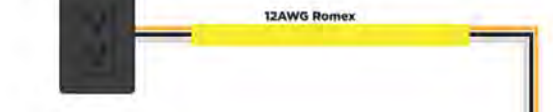

**GFCI Outlet, AC**

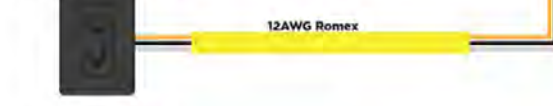

**Conntek Outlet**



**AC Main Breaker: 30AMP**  
AC Branch Circuit #1: 15AMP (Kitchen Plug)  
AC Branch Circuit #2: 15AMP (A/C Only Plug)  
AC Branch Circuit #3: 15AMP (Converter)

**DC Circuit #1: (Exterior 12v Outlet & LP/CO)**  
**DC Circuit #2: (Bed USB Outlet)**  
**DC Circuit #3: (Kitchen 12v/Voltmeter)**  
**DC Circuit #4: (Kitchen Power)**  
**DC Circuit #5: (Entry Power)**  
**DC Circuit #6: (Battery Charging/Return)**

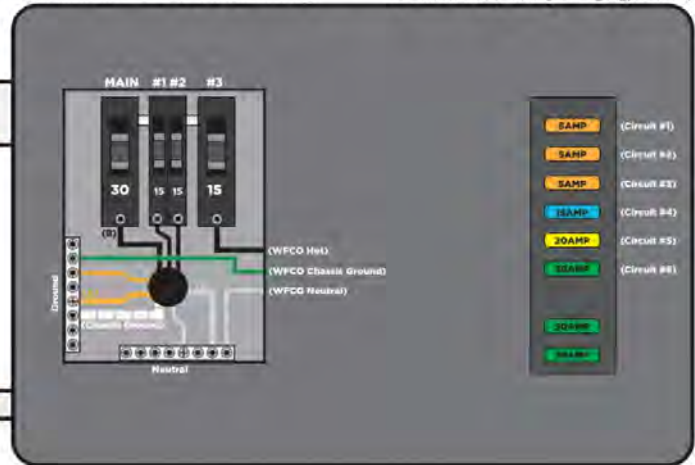



**WFCO PRE-WIRING**  
**M-09-2200-RO**

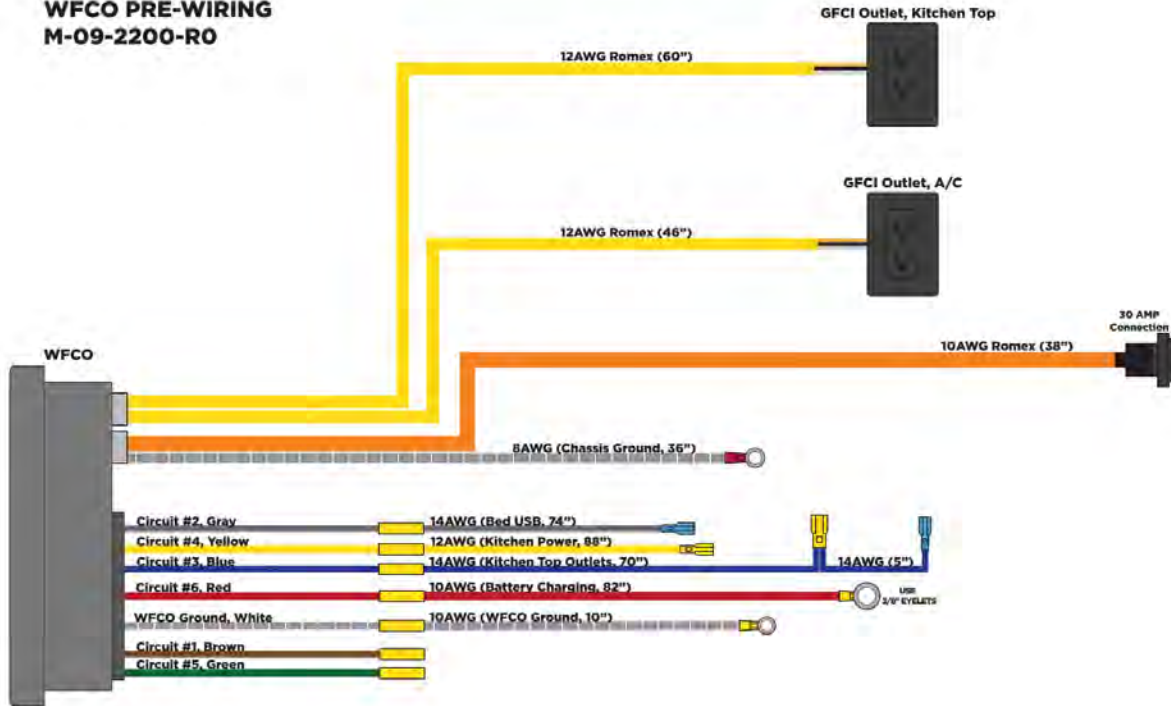

**M-09-3000-RO CABIN HARNESSES**  
**ALL WIRES SHOWN ARE 18 AWG**

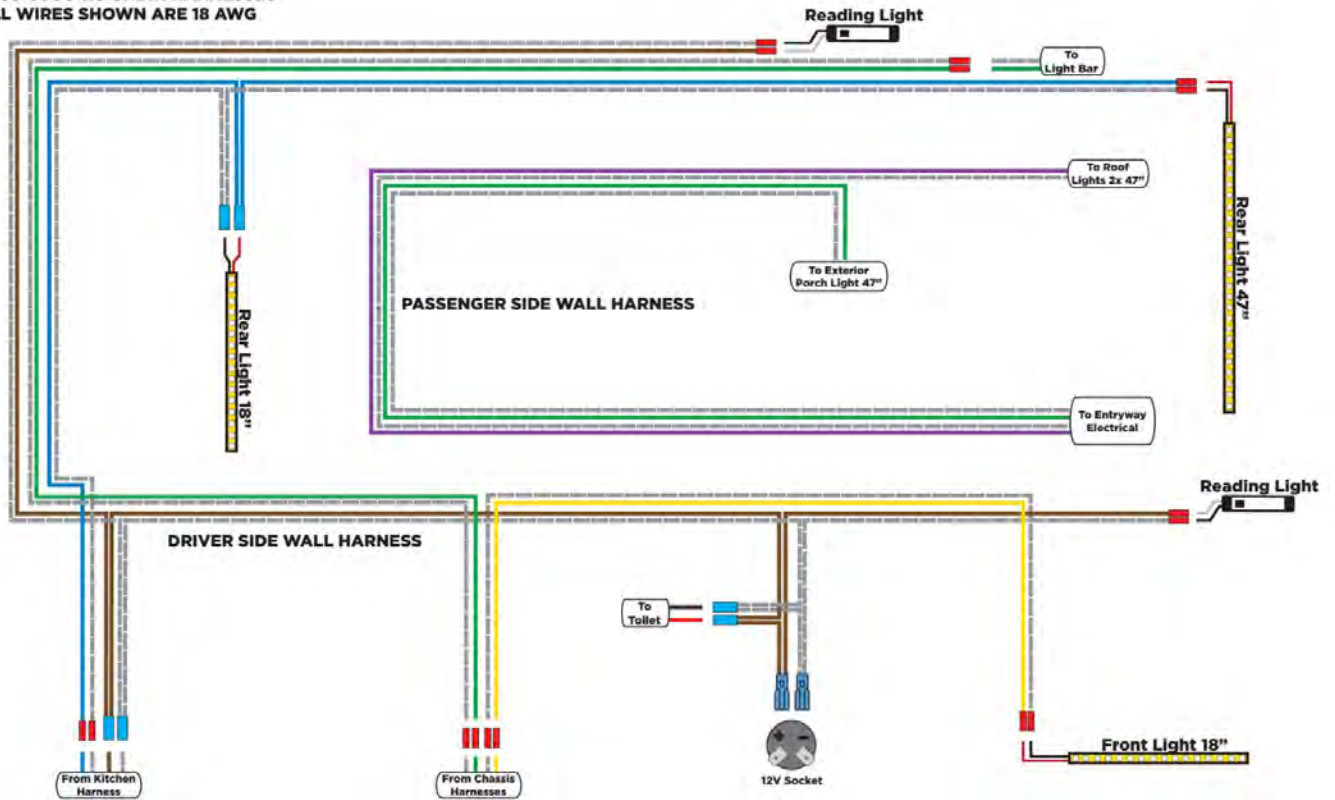

**PROPANE KITCHEN ELECTRICAL  
M-09-9100-RO**

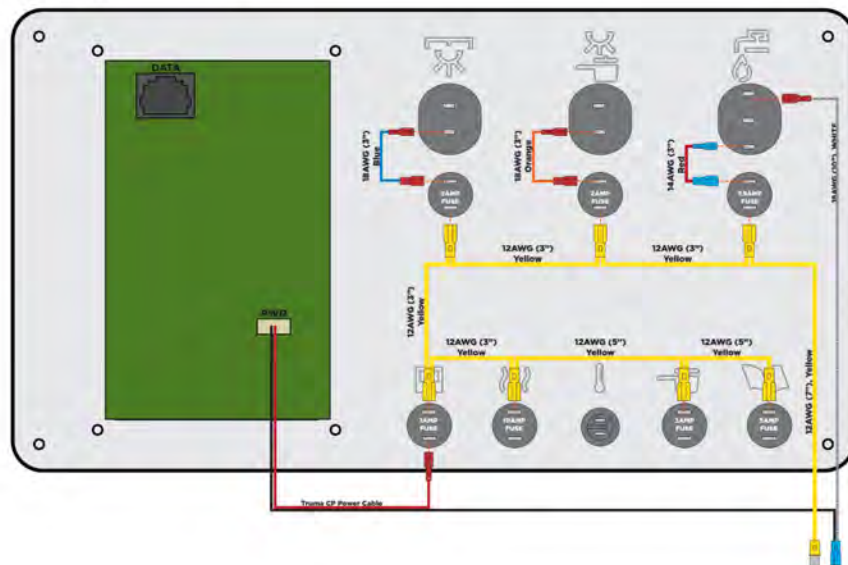
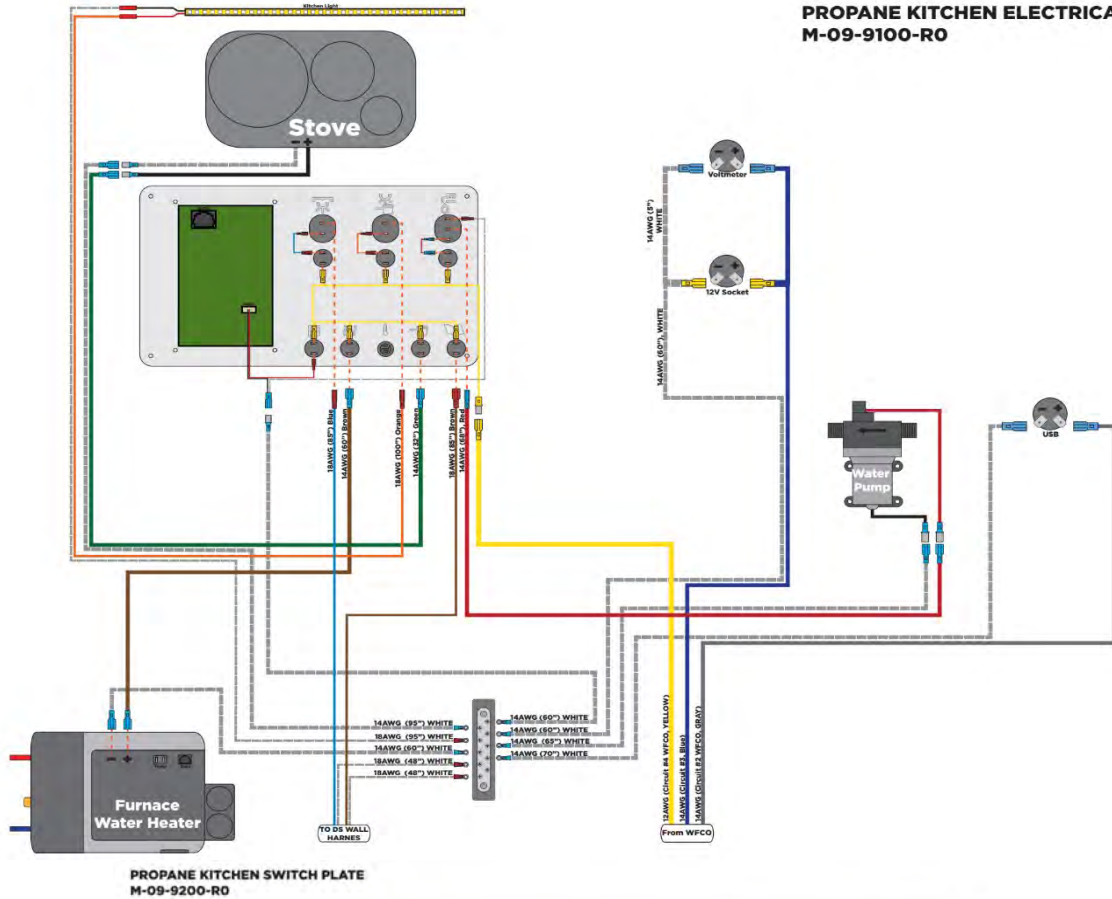

**WARNING: NEVER REPLACE INSTALLED CIRCUIT BREAKERS OR FUSES WITH CIRCUIT BREAKERS OR FUSES OF HIGHER AMPERAGE RATING THAN THOSE ORIGINALLY INSTALLED. THIS COULD OVERHEAT THE WIRING AND START A FIRE.**

## BATTERY

*overview ...* a single DEEP CELL 12-volt battery is supplied with your trailer. It is specified and installed by your dealer. There is room for two (2) batteries. You may purchase a second battery separately. See below battery specifications and technical information as well as such information provided by the manufacturers of any additional and/or replacement batteries you purchase.

**WARNING: BATTERIES CONTAIN SULFURIC ACID, WHICH IS HIGHLY CORROSIVE, FLAMMABLE AND EXTREMELY DANGEROUS. THUS, WE STRONGLY RECOMMEND THAT YOU HAVE ALL BATTERY MAINTENANCE, SERVICING AND INSTALLATION PERFORMED BY A QUALIFIED TECHNICIAN.**

The battery and charging system are the heart of the 12-volt DC system. Thus, it is important that you keep the battery fully charged and monitor its charge state. Low battery charge and/or bad batteries are common causes of poor appliance and other component part performance. Fuses and circuit breakers can fail even without a short circuit under low voltage.

The converter/charger system in your Mantis will help you manage your electrical requirements and charging needs. The converter/charger monitors and charges your batteries as needed when connected to a power supply. Please refer to the manufacturer's information regarding the converter/charger for more information. This is supplied with your trailer. Please also refer to the "Electrical System" chapter herein.



WFCO power center

There is a 12v monitor in the kitchen cabinet. This will let you monitor current or charging voltages.



Your trailer will generally be in one (1) of the following three (3) power states when in use: (1) *dry camping (not connected to shore power) ...* you will be using battery power only to operate lights, fans and other DC components, and thus, discharging the batteries. Exercise constant vigilance in keeping your battery charged when dry camping. Make every reasonable effort to conserve your battery power (i.e. turn off lights and appliances when not being used);

(2) *being towed ...* if your tow vehicle has been wired properly, your trailer's battery will charge while being towed (the rate of charge varies depending on the tow vehicle); and

(3) *connected to shore power* ... when you are connected to shore power (an external 120V power source), all batteries will charge automatically and will be regulated by your converter/charger so they don't overcharge. This is the fastest method of recharging your trailer. Connect to shore power through the marked 15 amp electrical inlet located on the rear driver's side of your trailer. Note: when parking the trailer for more than a few days, detach from tow vehicle, turn off appliances and lights, and plug in to shore power if available to ensure the battery is charged in advance of next use.

4. Connected to solar panels when off the grid. Mantis are prewired to accept specific solar panels (via the inlet at the rear driver's side of the trailer, or on the driver's side exterior). The rate of charge will vary based on the panels and solar exposure. PLEASE REFER TO SPECIFIC MAKES OF SOLAR PANELS ACCEPTED BY THIS SOLAR POWER INLET ON THE STICKER LOCATED NEAR THIS INLET.

*installation* ... proper battery installation is critical. Thus, please see a qualified technician for the installation and/or replacement of your trailer batteries.

*inspection and monitoring* . . . we recommend that you inspect and monitor the charge of the battery at least once a month and prior to any trip. During your inspection, look for cracks in the cover and case, and check vent plugs. *Have a qualified technician replace any cracked or broken plugs or other such items, and confirm that the hold-down hardware is tightly secured, that the battery box, tray or compartment is clean and free of corrosion, and that the vent caps and terminals are secure and tight.* Note: Do not store anything in the trailer battery compartment, box or tray other than the battery and its various components.



Battery compartment at base of kitchen cabinet – shown no cover, no batteries

*charging and storing* ... keep the batteries fully charged but be sure not to overcharge the battery. If the trailer is charging via a power cord, shore power, your power distribution center will prevent overcharging. To check or monitor the battery charge, insert the readout accessory into any 12V outlet on the Mantis.

Here are three ways to charge your battery:

1. Plug into any 120V outlet via the inlet located on the rear driver's side of your Mantis.
2. Plug the trailer's 7-pin connector into an appropriately wired tow vehicle while the vehicle's engine is running.
3. Plug compatible solar panels into the inlet located on the rear driver's side of your Mantis. Ensure a charge controller is inline between panel and batteries.

WHEN CAMPING, DETACH 7-PIN CONNECTOR FROM TOW VEHICLE. OTHERWISE IT IS POSSIBLE THAT THE TRAILER MAY DRAIN THE TOW VEHICLE'S BATTERY.

WHEN TRAILER IS IN STORAGE, MAINTAIN THE BATTERY BY PLUGGING A 120V POWER SOURCE INTO THE MANTIS'S ELECTRICAL INLET (LOCATED AT THE REAR DRIVER'S SIDE). THE CHARGE CONTROLLER WILL MAINTAIN A PROPER CHARGE WITHOUT OVERCHARGING.

OR

USE THE BATTERY CUT OFF SWITCH LOCATED IN THE KITCHEN CABINERY TO DISCONNECT BATTERY. (When battery disconnect is in OFF position it is still possible to charge the battery from the two vehicle or solar panel)





*dead batteries* .... If your battery is dead, plug into shore power if available. Reduce the loads on the battery by turning off any lights, 12-volt DC powered equipment and all non-essential items to allow rapid recharge. You may also connect the 7-way connector to your tow vehicle and run the engine at high idle to increase charging current and possibly reduce charging time. If your tow vehicle battery is dead or discharged, an external jumper battery or battery charger must be used to either start your tow vehicle engine, or generator, if any.

## **APPLIANCES AND FIRE EXTINGUISHER**

The following appliances are *optional*. If you choose to equip your trailer with any options, *please be sure to read and follow the separate manuals and instructions regarding safety, risks, use, maintenance, care and service associated with each option, add-on, appliance and/or equipment.*

*air conditioner* .... For best performance:

- Park in a shaded area
  - Keep blinds down and closed
  - Keep windows and doors closed, allowing the trailer to cool efficiently
  - If you have an awning, use it to protect trailer from direct sunlight
- Try to avoid using heat-producing items inside trailer  
Turn on the AC unit early in the morning  
Maintain AC unit as instructed by manufacturer

*refrigerator* .... the refrigerator, if any, operates on the trailer's 12V battery system. Please refer to the applicable separate manufacturer instructions for care and operation.

## **FIRE EXTINGUISHER and SMOKE DETECTOR and CARBON MONOXIDE DETECTOR and PROPANE DETECTOR**

Your trailer includes a fire extinguisher, which is located in the front of the Mantis near the kitchen. Test and operate according to manufacturer instructions. Your trailer also includes a battery powered smoke detector and a separate carbon monoxide detector and propane detector, which should be tested prior to and during each camping trip.



**2020 MANTIS FLOOR PLAN - SAFETY**

Mantis Trailers meet NFPA 1192-2018, NEC 2017 and ANSI/RVIA LV-2018

19' Overall Length  
16' Cabin Length

7'6" Overall Width

VIN and State Labels



TOP

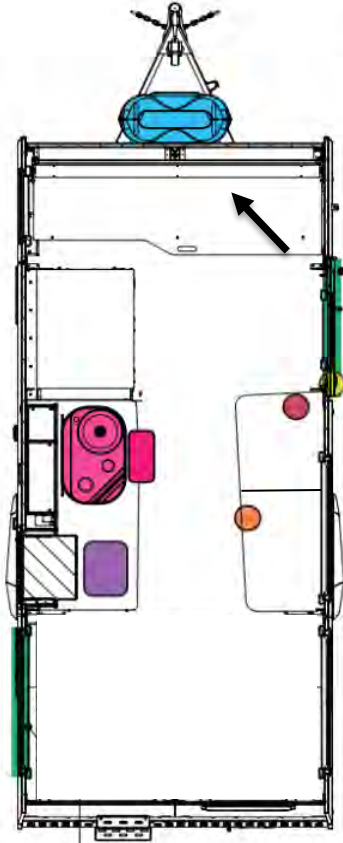

Window 36"x18"  
(Emergency Ingress/ Egress)

Side Door 32.75"x51"  
(Main Ingress/ Egress)

SECTION 3-B

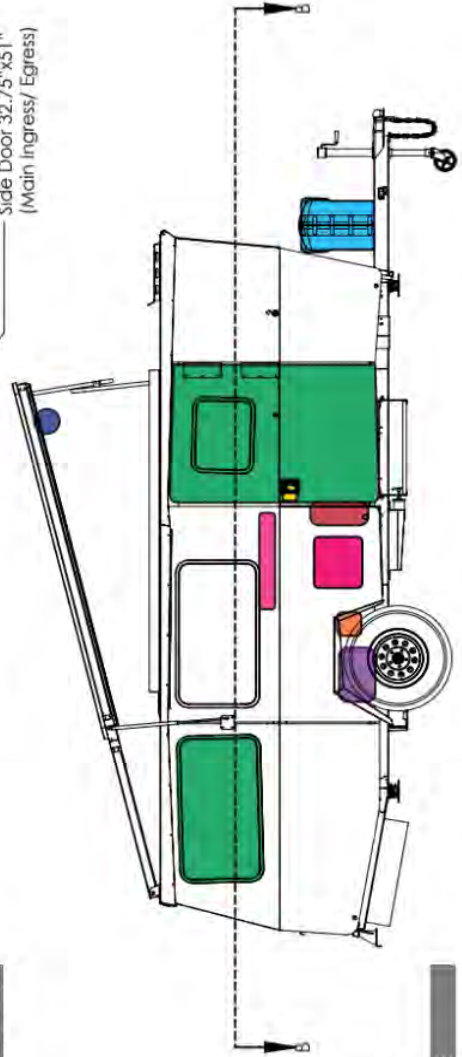

SIDE

	Exits
	Interior & Exterior Operated Door Latches
	Smoke Detector
	LP/CO Detector
	Fire Extinguisher (2lb 58°C)
	Battery Box
	Propane Appliances (Cooktop, HW, and Furnace)
	Propane Tanks





## PRE-TRAVEL CHECKLIST

### *interior ...*

- turn off all switches at kitchen switch panel or on ceiling.
- turn off and close all appliances, if not in use. You may keep the refrigerator on while driving.
- be sure your cargo berths are secured, and close and latch all windows
- be sure roof top is closed and latched properly at all locations from inside and outside.
- be sure tent fabric is secured but not pinched.
- be sure shoreline power cord, 7-pin connector and hoses are secured (and properly attached, if applicable).
- close and lock both doors.

### *exterior ...*

- be sure the stabilizer jacks and door step are fully raised and secured.
- be sure wheel lug nuts are tight and secure.
- check that all tow vehicle and trailer lights and brakes are working in synchronization.
- check brakes with multiple applications in an empty parking lot.
- confirm brake controller, if any, is operating properly.
- be sure hitch assembly is secure, and that safety chains and breakaway switch have been properly attached.
- check underneath trailer for any damage or displacement.
- emptying water tanks prior to travel will decrease tow weight and improve fuel efficiency of your tow vehicle.

### **WARNING: DO NOT ALLOW ANYONE TO RIDE IN TRAILER WHILE IT IS BEING TOWED.**

Important Note: This is not an exhaustive list nor is it intended to be. Use common sense when preparing for a trip and all other helpful resources available to you.

### OTHER IMPORTANT PRE-TRAVEL CONSIDERATIONS

- be sure to pack wheel chocks and blocks.
  - be sure roof rack cargo, if any, is secure.
  - be sure to monitor your battery's charge before and during your trip. Charge battery before travelling, if necessary.
  - read and follow the manual and all pertinent instructions provided to you by your tow vehicle manufacturer.
  - be sure tow vehicle is operating fully before any trip, correcting any problems before travel.
  - bring flashlight and batteries.
  - make sure your cell phones are charged and that you have phone chargers.
  - bring extension cords, if necessary.
  - take spare tire.
  - check for any potential fire hazards, and eliminate them, if any.
  - weigh your load before trip, making sure it does not exceed your GVWR.
- contact your dealer or Taxa Inc. if you have any questions before your trip.**

## SITE SELECTION AND SET UP

With time and experience, you will get better at spotting and identifying good camping sites. Although they will vary to some degree, all good sites will (a) be level (at least 'ish') and (b) have a firm, not soft, ground that will support the weight of jacks and/or other support devices. There are also many public camping sites that provide electrical and other useful hook-ups or services. Once you have chosen your site, we suggest that you refer to the following important tips for your set-up:

*level and stable* .... (1) Before uncoupling, level the unit from side to side if desired with wood or plastic leveling blocks. Place the blocks on the ground forward of the wheels and tow the unit onto the blocks.

- (2) Lower the jack onto blocks or pad, if necessary;
- (3) Use a trailer level to ensure trailer is level;
- (4) Once the unit is level, use wheel chocks or blocks to prevent the trailer from moving;
- (5) uncouple the trailer from the tow vehicle, unplug 7 pin connector from vehicle;
- (6) Lower the stabilizing jacks until they firmly engage. Be sure all jacks have about the same pressure on them.

Note: Before resuming travel, be sure that the stabilizer jacks are fully retracted/raised and that the trailer has been fully closed.

### OPERATION

**STEP 1.** Park RV on level ground, prevent wheels from rolling by using tire chocks.

**STEP 2.** Level trailer fore and aft using tongue jack or landing gear.

**STEP 3.** Check level gauge for low side of trailer, crank down stabilizers on low side first, bringing the trailer to a fine level position.

**STEP 4.** Crank down stabilizers on opposite side of

trailer to insure maximum stability. Then re-snug stabilizers on low side of trailer if necessary.

**NOTE - BEFORE MOVING TRAILER:** Crank up stabilizers to fully closed position and tighten 1/4 turn to secure in travel position (this prevents stabilizers from working open due to road vibration).

**MAINTENANCE:** Use small amounts of WD-40 or similar lubricant on drive screw threads and bolt locations as required.

**WARNING: DO NOT ATTEMPT TO USE JACKS STANDS OR STABILIZER JACKS TO JACK UP THE TRAILER OR SUPPORT THE FULL WEIGHT OF THE TRAILER. DO NOT ATTEMPT TO LEVEL, RAISE OR OTHERWISE PLACE ALL OF THE WEIGHT OF THE TRAILER ON THE STABILIZER JACKS. STABILIZER JACKS ARE NOT DESIGNED TO BEAR WEIGHT.**

*set-up cont.* ... once the unit is safely leveled and stabilized, continue with set-up:

- (1) open roof (see below listed steps);
- (2) connect to shore power, if available;
- (3) connect to site water supply, if available, and
- (4) set up the remaining features and/or options as needed.

OPENING ROOF .... follow these simple steps:

1. Enter the trailer and unlatch two (2) red-colored interior hold-down latches (located at entry door and over WC), both of which have a thumb catch.



2. Push roof up from center front of roof interior. Place hands on either side of center spine and push upwards. Gas springs will assist the lift and prevent a sudden closing.

CLOSING ROOF .... follow these simple steps:

1. While inside the trailer, pull the hanging straps that are attached at the highest point of the roof down;
2. The roof will close slowly as the force is dampened by two gas springs. Pull slowly and steadily.
3. Before the roof closes all the way pull in any tent side material that have billowed outwards.
4. Secure the two interior latches. Make sure the thumb catches are caught!
5. Walk around the exterior of the trailer to ensure that no tent fabric is caught in the roof; no jacks, cords, hoses, etc were left in place



**SHOWS TENT ROLLED UP AND NOT IN LATCH**

**You must roll tented side fabric to ensure side latches do NOT catch and/or tear/cut fabric walls while latching. Be sure to carefully roll and tuck the fabric side walls into the unit when lowering the roof. Otherwise, the tented fabric is likely to catch on the roof's interior fastening clamps, causing rips and tears. Rips and tears and other damage caused by improperly closing the roof are excluded under the Taxa Inc. Limited Warranty. See "Limited Warranty" section herein.**

**WARNING: BE SURE TO WATCH YOUR HANDS AND FINGERS WHEN SECURING LATCHES.**

INSTRUCTIONS TO TAKE OUT AND INSTALL A TENT SIDE .....

Your Mantis tent side is your friend. It keeps you dry in the rain and shaded from the sun. Sometimes a bird may poop on it, or maybe your daughter heaves a mud ball, it misses their brother and hits the tent side ..... (taking the tent off and spraying it with a hose usually takes care of these things). If not correctly installed it can actually cause your Mantis to leak.

It goes on and off really easily. You should be comfortable in doing so. It only takes a few moments in either direction.

TAKING IT OFF:

1. inside the trailer, start at one corner of the inside roof and detach the bottom corner of a side. It is attached with Velcro.
  2. use that corner to start pulling the tent bottom edge off as you walk around the trailer's inside
  3. repeat for top edge, gather tent side in your arms as you go. The Mantis Tent is created in four segments. Detach the Velcro that attaches the tent. Fold carefully.
- Done.

PUTTING IT BACK ON:

1. separate the Mantis tent into its four sides and four corner pieces
2. open your Mantis roof. Attach side panels first. The attach front and rear panels starting at the center of each.
3. from the exterior attach all four corners.

10. visually inspect outside edge of tent side to ensure that the rain flap is not caught in the bottom Velcro but instead sheds water.

Suggestion:

If you are storing your trailer outside for some time between uses (over the winter, for a month or two), you can detach the lower Velcro of the tent side, tuck it into the inside of the trailer and latch the roof with the tent side hanging on the inside of the trailer. This removes any possibility of permanent wrinkles.

### Awning Instructions

An awning or shade structure can be a very useful addition to your Mantis. Shelter from the sun, rain and bugs can be achieved with different styles.

TAXA sells an 8 foot wide awning that covers the side door, 'food service' window and approximately 50 square feet to shelter you from the sun and rain. You can purchase screen enclosures and outside room enclosures that pair with this awning.



### VENTILATION

*overview* .... good ventilation and indoor air quality is essential to long-term enjoyment of your trailer. Inadequate ventilation can increase indoor pollutant levels. To maintain good air quality, be attentive to proper ventilation of your trailer, keep it clean, and prevent and avoid unnecessary air pollutants. Common indoor air pollution sources include molds, pollen, pet fur dander, secondhand smoke, carbon monoxide from burning propane and other fuels, and household cleaners.

Travel trailers are much smaller than homes. Thus, the exchange of air inside a travel trailer is significantly less than a home. Proper ventilation is an ongoing process, occurring before, during and after use, and at times when the temperatures and humidity are elevated. Decreasing the flow of air by sealing the travel trailer may increase the presence and/or concentration of indoor air pollutants, such as but not limited to, molds and household chemicals. Improve ventilation by opening windows, using fans and opening vents, running the air conditioner, or some combination thereof. We also recommend that you do not smoke or use any type of bug or other chemical spray inside your trailer.

**WARNING: Your trailer was designed for recreational use and short-term occupancy only. Long-term occupancy can create conditions, which if not managed properly, can be hazardous to your health and cause significant damage to your trailer.**

The following are three (3) basic strategies recommended by the Environmental Protection Agency (EPA) to improve indoor air quality:

(1) *remove sources* ... eliminate sources of pollution and/or reduce their emissions. Pollutants that this strategy can have an impact upon are: (i) Biological Contaminants such as bacteria, molds, mildew, viruses, animal dander, and pollen, (ii) Household Products such as paints, varnishes, cleaning and disinfecting solutions, cosmetics and hobby products, and (iii) Pesticides.

(2) *ventilation* ... increase the amount of outdoor air coming indoors. Typically, trailer air conditioners, for example, do not mechanically bring fresh air into the unit. Simultaneously opening doors and windows to allow fresh air in along with turning on fans to take inside air out is an effective way to improve ventilation. Remember, if there is insufficient outdoor air entering a trailer, pollutants may accumulate to higher levels.

(3) *air cleaners* ... air cleaners are designed to remove particles from the air. There are many types and sizes of air cleaners available to you on the market. Note: Air cleaners are not generally designed to remove gaseous pollutants. The effectiveness of an air cleaner depends on how well it collects pollutants from indoor air and how much air it draws through the cleaning or filtering element. For more information about Ventilation, Indoor Air Quality and its effects, please refer to [www.epa.gov/iaq](http://www.epa.gov/iaq).



## MOISTURE/CONDENSATION

The relatively small volume and compact construction of travel trailers means that the normal activities of even a few persons can lead to rapid, visible moisture saturation in the trailer, especially in cold weather. Note: some estimates indicate that a family of four can vaporize up to three gallons of water through daily breathing, cooking, bathing and washing. Just as the moisture collects on the outside of a glass of cold water during humid weather, moisture will condense on the inside surfaces of the trailer during cold weather when the relative humidity of the inside air is high. Unless water vapor is carried outside, it will condense on the inside of the windows and walls. Thus, when you observe signs of excessive moisture and condensation in the trailer, take action to minimize the effects. Such action steps *in non-extreme hot or cold weather conditions* may include but not be limited to the following: Allow excess moisture to escape by ventilating with outside air. Open windows to provide circulation of outside, dryer air to the inside. While this ventilation may increase the heating load during cold weather, it will greatly reduce water condensation.

Minimize moisture released inside the trailer such as steam from excessive boiling water or other use of hot water. Remove water or snow from shoes before entering the trailer. Avoid drying wet or damp clothing, towels, gear and other items inside the trailer.

In hot, humid weather, start the air conditioner, if applicable, early in the day.

Manage the inside temperature during cold weather. Remember that the higher the temperature inside (in cold weather) will cause condensation to form on areas that are not insulated as well as others (windows, vents, wall studs, etc.); try to avoid drastic, quick temperature reductions, which can increase moisture condensation inside.

Properly maintain and secure the exterior of the trailer. This will help keep a tight barrier against water intrusion. Note: using your trailer in severe climates or weather conditions (which is NOT recommended ... see "severe weather use" section), such as extreme hot, humid or cold weather, will require extra care, attention and maintenance of moisture-related issues and relative humidity conditions inside the trailer.

### *Other tips to minimize condensation*

When, for example, washing dishes, hair drying, laundering, cooking and using appliances and non-vented gas burners, keep a window partially or fully open turn on your fan, if any; Keep all doors and vents open when practicable; Allow air to circulate inside cabinets (leave doors partially open) so the temperature inside the cabinet is the same as in the rest of the unit. Clean any spills immediately.

On laminated surfaces and the floor (use mold or mildew-killing cleaning products. Check sealants regularly and reseal when necessary to avoid water leaks. Use LED, or fluorescent lights and minimize prolonged use of incandescent lights, which produce heat and may contribute to condensation issues.

Remember ... your natural tendency may be to close the trailer tightly during cold weather. This will actually make any moisture/condensation problems worse. You need to ventilate the trailer, allowing inside air to travel outside.

Note: If the tips outlined here are not effective in controlling condensation, it may be necessary for you to invest in a dehumidifier to reduce the health risk to you or your family as well as prevent damage to your trailer.

## MOLD

Molds are pollutants found in virtually every environment. Left unchecked, molds break down various materials such as wood products and fabrics. Mold can rapidly grow indoors if it is warm and humid. By controlling relative humidity (moisture) as outlined herein, the growth and potential for growth of mold and mildew can be greatly reduced.

### **Additional Web Resources**

We also recommend that you visit the following web sites which maintain information about indoor air pollutants, including molds and formaldehyde, along with ways to improve indoor air quality:

<http://www.epa.gov/iaq/pubs/insidest.html>

<http://www.atsdr.cdc.gov/tfacts111.html>

<http://www.epa.gov/iaq/molds/moldguide.html>

<http://www.formaldehyde.org/>

<http://rvia.org/> (Recreational Vehicle Industry Association's Web site – Under the Technical Information

**WARNING: Taxa Inc. carefully chooses the production/manufacturing materials for its trailers. However, Taxa Inc. does not warrant or otherwise represent that its production/manufacturing materials are formaldehyde free.**



## FOUR SEASON USE / EXTREME WEATHER

Your trailer was NOT designed for use in extreme climates or weather situations. It was designed to be used any season you wish. Some conditions require special consideration or preparations.

**If conditions are extreme due to weather or other natural or unnatural causes BE SAFE!  
Get yourselves to safety. Get your vehicles to safety as a secondary concern.**

Your trailer was designed for short-term use (typically seven days or less) in normal, moderate temperature and climate conditions. Normal, moderate temperatures are between 32 degrees F and 100 degrees F. Climates falling outside of this range are considered extreme for purposes of this manual and your trailer. Be advised that some of your trailer's systems and components are not appropriate for use in extreme climates (see further notes below). Please be advised that some damages, losses or injury arising out of use of your trailer in extreme climate conditions may not be covered under the Limited Warranty. See Limited Warranty section herein. **Thus, before you consider using your trailer in extreme conditions, please read the following:**

*plumbing system* ... your trailer's fresh and waste water plumbing will require preparation and or attention during extreme cold weather use. The interior plumbing can be kept from freezing either by use of your furnace OR by draining all lines and traps. The fresh water and Grey water tanks are exterior and not insulated. Freezing temperatures can cause extensive damage to the plumbing system, resulting in costly repairs or replacement not covered under your Limited Warranty. Your plumbing system and components should not be used in below freezing conditions. Remember that no portion of the plumbing system is situated in a heated compartment, and much of it is directly exposed to the outdoor air and especially susceptible to freezing. Thus, be sure to take notice of where all plumbing is situated on your trailer. You can comfortably camp in winter! However, your drinking water should come from portable water containers that you can keep unfrozen or do not care if they freeze. Please also refer to the "Plumbing System" section.

*insulation and heat* .. keep the inside of the trailer heated and insulated. Use your furnace that is integrated into the trailer to keep interior temperatures modulated. Follow all manufacturer's instructions for safety.

The panels of your trailer are insulated. You may consider installing heat tape or similar underneath the trailer and around exterior plumbing components. If applicable, wrap the fresh water inlet plumbing and waste lines with heat tape. Be sure to follow all use and installation instructions provided by your heat tape, etc. manufacturers. Periodically check the trailer systems and components.

*additional tips* .... thoroughly dry, thaw out and drain water from hoses before storing, and drain holding tanks if possible. This should reduce the likelihood of damage to your tanks from a freeze. Supply your trailer with bottled water for drinking, cooking, washing and brushing your teeth. You may also consider winterizing your trailer. See "Winterization" section herein.

*battery and electrical systems* ... If you are connected to shore power or have a generator, you should have all the power you need to operate appliances. You can easily run your furnace or, if with shore power, can plug in a portable electric heater. However, if you are dry camping (i.e. no shore power or generator), your battery or batteries will be your only source of power, and thus, your primary electrical system concern in extreme cold. Be sure to keep the battery charged and conserve available energy when possible. *Remember that there is no substitute for common sense when camping in extreme weather conditions.* Please also refer to the "Battery" and "Electrical System" sections herein.

### EXTREME HEAT and COLD

Please use common sense when camping. Extreme heat and extreme cold can cause injury and or death, especially to the elderly and young. Take all necessary precautions when camping.

Here are some notes for camping in:

#### WINTER:

- bring bottled water for drinking, washing, brushing teeth etc. Keep those plumbing lines and tanks free from water in prolonged freezing conditions.
- your furnace will keep you warm and toasty even with the roof up. We have been to well below freezing in our experiences.
- have a good sleeping bag, zip two together
- some people close the roof at night for extra insulation





**SPRING:**

- no special considerations unless you are up high or far north where temps may drop below zero at night.

**SUMMER:**

- your trailers roof is insulated! on the hottest of days being inside is like being on a porch – shady and with great cross-ventilation. Have a siesta in the middle of the afternoon and stay up late!
- get a clip on 12v fan or two!
- some climates support swamp cooler use.
- (some need an AC)

**FALL:**

- no special considerations unless you are up high or far north where temps may drop below zero at night.



## GENERAL CARE AND MAINTENANCE

Regular care & maintenance of your trailer is important in furthering safety and dependability. Keep good records of all service and maintenance performed on your Mantis. These records may be necessary for limited warranty purposes or may assist in future repairs. Always refer to the manufacturers' care and maintenance recommendations for installed appliances.

*exterior finish* ... your trailer's exterior is made of painted aluminum composite panels, which are durable and easy to maintain. Aluminum is lightweight and relatively soft, naturally showing wear over time. Cosmetic marks are intrinsic to aluminum and do not constitute a fault in material or defect in workmanship. Routine maintenance is the best way to minimize and guard against cosmetic changes due to weathering. Wash the trailer exterior with a soft cloth, warm water and soap thoroughly, paying special attention to the graphics. Never use strong solvents or abrasives when cleaning. Also, be aware that power buffers and high pressure washers may damage or totally remove the graphics. See also the following summary of do's and don'ts:

Do use soft cloths to clean

Do be careful around graphics, washing with the graphics, not against them.

Do not use products containing ammonia or caustic, harsh cleaning agents.

Do not use high-pressure washers, rotating brushes (i.e. in-car wash facilities), or power buffers.

Do not dry wipe surfaces

Do not use rubbing compounds.

*frame and chassis* .... Over time, various weather and climate conditions may lead to corrosion your trailer frame and chassis. Be sure to rinse the trailer undercarriage, wheel wells, hitch and bumper of all dirt, oil, tar, salt and other debris periodically and as needed. Remember to routinely inspect for evidence of rust. Do so frequently when camping in or near coastal regions.

*hitch couplers* ... Inspect hitch couplers before each trip. Clean and lubricate the ball socket and clamp monthly using wheel bearing grease. If hitch assembly and coupler appears damaged in any way, contact your dealer and resolve the problem before travel.

*safety chains* ... Inspect safety chains before each trip. Replace them before travelling if they are damaged or compromised in any way.

*jack* ... Inspect and test the jack before each trip. Clean and lightly apply oil periodically and as needed. If your jack needs repair or other service, see a qualified technician.

*tires and wheels* ... inspect your trailer tires, checking air pressure regularly and before each trip. Keep them inflated to recommended pressure, which is located on the tire sidewall. Keep a tire gauge in your tow vehicle or trailer. Have the tires rotated by a qualified technician at least every 5,000 miles.

*brake adjustment* ... have your trailer's electric brakes adjusted after the first 200 miles. Have them tested for brake drag every 3 months or 3000 miles, whichever is earlier. When adjusting brakes on any vehicle, either replace or adjust all brakes at the same time, or at least both brakes on the same axle. Qualified service personnel should perform all required work on brakes.

*sealants* ... Inspect all sealants/seals (i.e. doors, windows, plumbing components, undercarriage) every ninety (90) days, when the seasons change, and before each trip. During your inspection, look for cracks, voids, shrinkage, and any other sign of deterioration. Replace sealant where necessary, using the same type of sealant. Contact your dealer or Taxa Inc. for suggestions concerning replacement sealants.

*tent sides* ... you may clean your trailer tent sides periodically with warm soap and water and then dry. The tent sides are made out of waterproof, flame retardant, breathable, Ultra-violet treated, high-performance material. While very durable, no fabric lasts forever. The best storage procedure, if the trailer is stored out of doors, is to park it under the cover of a roof, trailer, cover or tarp. Keep your tent sides dry when possible to avoid prolonged exposure to mildew, which may damage them. If you have mildew, use the following recipe:

*Mix 1 cup of salt, 1 cup of lemon juice, and 1 gallon of hot water  
Wash moldy/mildew areas of the tent with a sponge  
Let dry*

Be aware that wind, water, sun, pollution, debris and neglect may all degrade your tent side fabric over time. Have the tent side



repaired at the first sign of fraying or tearing. Take care to protect the fabric from metal parts.

*ceiling, interior walls, countertop and table ...* clean with soap or other mild, non-abrasive cleaner, warm water, and a damp cloth. Do NOT use strong, harsh chemicals, and limit water/moisture exposure to ceiling and walls when cleaning. Excessive moisture may damage ceiling and walls. Be sure thoroughly dry ceiling and walls after cleaning. Avoid using abrasive pads and scouring powders, which may dull surfaces and increase exposure to future staining.

Remember to use a chopping block or cutting board when using knives on the countertop. Pots and pans straight from the burner or oven should be placed on lined hot pads and not directly on the counter surface.

*faucets and fixtures ...* use only a damp soft cloth or sponge to clean. Do not use abrasive cleaners or materials as they may damage the finish.

*fabric and upholstery ...* Berth cushions are made of a fixed marine-grade vinyl. Clean them with a damp cloth and mild soap or other cleaning product. Be sure to dry thoroughly after cleaning. Folding couch cushions are made of nylon which may be machine washed cold and air dried.



## STORAGE, WINTERIZATION & BRINGING OUT OF STORAGE

If storing your trailer in persistently cold weather (less than 20 degrees F), you must prepare your trailer appropriately. We recommend that you store your trailer in a dry, level, well-ventilated area protected from the elements. Use blocks, chocks or ramps for the wheels, if necessary. A garage is ideal. Refer to and follow the following storage preparation guidelines:

### *interior ...*

- Open your refrigerator, if any, and remove all food items, block lid open to provide air movement
- Spread out your upholstery so that air can reach all sides
- Open all cabinet doors and drawers, including interior storage area
- Place containers of moisture-gathering beads in the trailer
- Clean the floor, walls and all surfaces

### *chassis ...*

- Lubricate all grease fittings on the axle hubs
- Check all tires for damage and set tire pressure to the maximum as indicated on the tire sidewall. Clean the tires and wheels with your regular soap/car wash solution
- Clean the tires and wheels as well as the underside of the trailer. Wash off mud and/or other road accumulations on frame, axles, and other components. Inspect and make note of damage to or in any areas or components.

### *exterior ...*

- Close all vents and windows and thoroughly wash the exterior, including roof, sidewalls and front and rear.
- Note any maintenance issues that arise that may be needed. Inspect the sealants around roof accessories (vents, racks, etc.), windows and doors, resealing as necessary before winter rains or snows accumulate (to prevent leaks when snow melts in spring)
- Cover all exterior appliance vents.
- Extend the awning (if equipped). Vacuum or sweep away branches, leaves, and any other debris. Wash with a mild, natural soap to reduce mildew. Allow to dry completely before retracting the awning.
- Be sure all exterior components, attachments, etc. (breakaway switch, cords, safety chains) are secured

Prevent trailer from rolling unexpectedly during storage - chock wheels, raise levelling jacks and retract step assembly.

*plumbing system ...* proper preparation and winterization of your trailer fresh water and waste water systems are **vital**. Freezing water expands, leading to possible rupture of tubing, fittings, tanks, and fixtures. Thus, be sure to empty the holding tanks before storing and winterizing. Drain hot water or fill traps and lines of system with non-toxic anti-freeze if you are unable to blow out any pockets of water with pressurized air. Turn off the water heater, if any, and let it cool. Remove access panel and remove HW distribution line per instructions in section PLUMBING SYSTEM. Siphon water from tank per same instructions. Reinstall HW line by firmly pushing it back into place.

- Open your sink and shower faucets, both hot and cold,
- Open the drain valves of both the gray and potable water tanks, and fully drain the tanks . Close the valves when tanks are completely drained /empty
- Disconnect the shower hose and drain the hose.
- Drain your TRUMA furnace and hot water heater per manufacturer's instructions.

**IMPORTANT NOTE: ALL FRESH WATER LINES MUST BE FLUSHED WITH FRESH WATER TO CLEAR THE FRESH WATER SYSTEM OF ANY ANTIFREEZE PRIOR TO USING FRESH WATER SYSTEM AFTER STORAGE**

*electrical system ...* preparation and winterization of the electrical system primarily revolves around your battery. Proper battery storage helps ensure both the powering up of your trailer systems on your next trip, and maximizing the life of your battery. Refer to the "Battery" section of this manual for proper storage information. Important Note: remember to turn off all electric loads in your trailer prior to storage.

## BRINGING OUT OF STORAGE

If your trailer was properly and carefully stored and winterized, taking it out of storage and prepping it for another travel season should be relatively simple. Note: if your trailer sustained damage while being stored, please consult with your dealer or Taxa



Inc. for information regarding repair or service options. The following checklist assumes that you stored your trailer with care:

Thoroughly inspect the trailer exterior, looking for animal nests in, for example, wheel wells, compartments or openings.

- Open all doors and compartments, checking for animal or insect intrusion, water damage, or other deterioration
- Check charge level in all batteries and recharge as needed.
- Check tire pressures and re-inflate to specified cold pressure
- Lube chassis
- Check all exterior lights, and replace as needed
- Drain, flush and sanitize the fresh water system as outlined in the General Care and Maintenance chapter.
- Inspect the drain hose for leaks and replace it if necessary
- Turn on sink faucets and all plumbing fixtures (faucets, water pump, Hot Water Heater), checking all joints and fittings and repairing leaks, if any.
- Check all 12-volt DC circuit fuses
- Operate all 12-volt DC lights and equipment
- Test the carbon monoxide detector as manufacturer's instructions (if equipped).
- Check your shore-line power cord, 7-pin connector, converter, all outlets, breakaway switch, and any exposed wiring. If defects are found, refer service to your dealer
- Operate air conditioning system (if equipped)
- Inspect and clean the interior
- Check sealants on and around the roof, body seams and windows, resealing as needed.
- Wash the exterior, thoroughly flushing the trailer underside.

## TROUBLESHOOTING

### Plumbing

Description	Likely cause	Fix
Sink backed up	Gray water tank full	a. open gray water valve to drain
	Sink Trap clogged	Remove kitchen shelving unit to access plumbing (secured with three bolts). Squeeze or remove trap to loosen clog.
Sink leak	Loose connection	Inspect sink drain, p-trap, and drain hose, tighten where necessary
Shower leak – Exterior	Loose connection, sand / grit in quick disconnect	Flush out exterior quick disconnect with water to remove grit
Shower leak - Interior	Loose connection(s) or bad washer	Tighten connection between shower wand and hose; between hose and faucet; remove faucet and replace rubber washer.
Shower drain leak	Loose connection	remove access panel below shower, visually inspect and tighten connections.
Plumbing leaks behind kitchen cabinetry	Loose connection	Pressurize system, observe leak spot. Tighten hose clamps and or PEX fittings.
Plumbing leaks under trailer	Loose connection	Check plumbing connections in problem area and tighten if loose
Water heater leak	loose connection or over pressured water.	Check push pull connectors at heater (push and pull them to check if one is loose!) at heater. Remove and re-insert. Ensure city water is below 125PSI and



		is being regulated by pressure regulator at inlet.
Low water pressure	Drawing air in water supply line	Tighten line by checking connections back to water tank from sink; tighten or re-connect. Check connection also beneath trailer. Sometimes you can hear air entering line when water pump is turned on.
Fresh tank won't fill	Hose improperly inserted	Use fill line connector
	Vent blocked up or crimped	Blow out vent line (small hole just above fill area) If crimped, remove bend in line. (accessible by removing service panel beneath Vberth)
Water pump not working	Check fuse beneath water pump switch at kitchen.	
		Replace pump
Water heater not working	no hot water	Verify that furnace (heat) is working. Check LCD control panel to make sure setting is correct, not on a timer that timed out. Check top of furnace unit itself to verify that small switch is in ON position. Note that water heating speed depends on inlet temp.
	no power (no LEDs on unit)	Check fuse on switch plate at kitchen.
	if propane	Check GFCI breaker where heater plugs into outlet beneath cabinet. Reset.  check TRUMA manual troubleshooting
	if propane	check propane supply and valves

Electrical

Description	Possible cause	Fix
120v circuit breaker pops	Wet extension cord	Dry cord, reset breaker.
Battery not charging (see LED volt monitor: – a well charged battery is between 12.6 and 12.8V	7-pin connection short	Check tow hitch connection and wiring. Verify that interior volt meter jumps up in voltage when car is turned on and 7 pin is in

- a charging battery is ~13.4V if trailer is plugged in to 120v - + ~.2V if solar or vehicle charging)		position. Check for loose or burnt wires in connector.
		Check trailer end connection
	Converter/charger	Test converter charger; replace converter element if necessary
	Battery charge	Check 30 amp fuses at WFCO Test battery
Circuit interruption	Overloaded circuit	Throw circuit breakers or replace fuses.
Lights flickering	Battery not charged	Check battery charge
Frig not functioning	Battery not charged	Check battery charge
	Blown fuse in frig plug	Check inline fuse in frig plug (green LED should be on in plug when functioning)
	Blown fuse in WFCO	Check fuse position #4
	check ON/ OFF LEDs	inside of frig, top left are on/off and temp settings
Ceiling lights not functioning	Blown fuse in WFCO	Check fuse # 2
Kitchen 12v outlet not functioning	Blown fuse in WFCO	Check fuse #3
Exterior 12v outlet not functioning	Blown fuse in WFCO	Check fuse #1
Kitchen counter lights not working	popped circuit	Check glass fuse beneath switch
Red step light not functioning	popped circuit	Check glass fuse beneath switch
Hot Water Heater not turning on	popped circuit	Check glass fuse beneath switch
Water pump not turning on	popped circuit	Check glass fuse beneath switch

#### Exterior leaks

Description	Possible cause	Fix
Roof leak	Roof latch loose	Adjust interior roof latches, tent side, ensure fabric and window toggles are preventing best seal
	damaged weatherseal	inspect, replace if required
Leak through tent side	Tent side not installed properly. Tent window open during rain.	Reinstall tent side (see SITE SELECTION AND SETUP)

#### Doors, windows, tent sides and graphics

Description	Possible cause	Fix
Side door gap	Missing/misaligned door gasket	Install door gasket



Key will not turn in cylinder	dirt or grit	Lubricant such as WD40
Window will not close	dirt or grit	Lift window to full open position. It should now go all the way down. Repeat if required
Window gap	adjust latches	interior latches have two locked positions, one closes to weather and dust, other leaves 1/8" gap
Broken window arm	Misuse	Install new part by pressing pin hole, removing broken arm, and replacing

**LIST OF AUTHORIZED DEALERS**

Our dealers and their contact information are subject to change. Please refer to our website [www.taxaoutdoors.com](http://www.taxaoutdoors.com) for updated dealer and contact information lists.



## your Mantis LIMITED WARRANTY

We want you to enjoy your Mantis without problems. As the owner, you are responsible for regular care and proper maintenance of your Mantis. Proper use, care, and maintenance will help avoid situations under which the Limited Warranty will not cover items due to neglect or misuse. Maintenance should be performed in accordance with this manual as well as the corresponding component manufacturer's manuals included within your trailer. If you have any questions at all regarding proper care or maintenance, please contact your dealer or Taxa Inc.

This limited warranty gives you specific legal rights. You may also have additional legal rights, which vary from state to state. Taxa Inc.'s warranty obligations are limited to the terms set forth herein and applicable law. Any additional statements concerning this limited warranty not included herein, whether oral or written, are not the responsibility of Taxa Inc. and should not be relied upon you. Please contact us if you have any questions regarding the following limited warranty.

### LIMITED WARRANTY COVERAGE

#### *Coverage - Plumbing and Electrical Systems*

Defects in material and workmanship in the plumbing and electrical systems as originally installed by Taxa Inc. only. The duration of this Limited Warranty for the plumbing and electrical systems is for a period of one (1) year, beginning on the date of purchase by the original owner/purchaser and ending one (1) year from such date.

#### *Coverage – Structural*

Defects in material and workmanship in the structure of your trailer as originally installed by Taxa Inc. only. The duration of this Limited Warranty for the structure is for a period of two (2) years, beginning on the date of purchase by the original owner/purchaser and ending two (2) years from such date. The structure includes only the frame, wall framing, floor framing and their connection to each other. It does not include attachments to the structure. Attachments include but are not limited to the following: axles, tented sides, stabilizer jacks, steps, couplers, vents, windows, shades, roof tracks, roof racks, appliances, add-ons, accessories, component parts, air conditioning unit, and refrigerator.

Taxa Inc. will, in its sole discretion, repair or replace, as necessary, the covered material or workmanship, at no cost to you and within industry standards. Taxa Inc. will also, in its sole discretion, use the same, substantially similar, new, remanufactured, refurbished, and/or reconditioned components, parts, materials and/or systems in fulfilling its obligations under this Limited Warranty. Taxa Inc., in its sole discretion, shall determine whether the dealer, service center, or other authorized facility is the appropriate location to perform the covered warranty repairs or replacement, if any. You shall be responsible for delivering the trailer to the dealer, service center or other facility designated by Taxa Inc. for such covered repairs or replacement, if any.

After a repair is performed, inspect it thoroughly. Go over the repairs with the dealer and/or service center representative. Upon your satisfaction, sign the repair order. In the event a problem should reoccur after you have left the dealer or other authorized facility, contact the dealer or Taxa Inc. as soon as possible so that the situation can be resolved quickly.

#### Owner's Responsibilities

Your responsibilities include: (1) carefully reviewing and following the information and instructions contained within this manual and all supplied component manuals; (2) proper care, use and maintenance of your trailer as outlined by this manual and all supplied component manuals; and (3) returning your trailer to an authorized dealer, service center or other facility authorized by Taxa Inc. to perform any necessary, covered warranty repairs, service or replacement.

#### WHO IS COVERED BY THIS LIMITED WARRANTY

Only the original purchaser/owner of the unit is covered under this Limited Warranty. This Limited Warranty is not transferable and does not cover subsequent purchasers/owners of the unit.

#### HOW TO PROPERLY SEEK A REMEDY UNDER THIS LIMITED WARRANTY

(1) Written or electronic notice of your warranty claim or claimed defects along with (2) your dated receipt as proof of purchase must be given either to the selling dealer or Taxa Inc. not later than ten (10) days after the expiration of the applicable limited warranty duration period as defined herein. Otherwise, your warranty claim will be considered untimely. Failure to timely notify of a warranty claim will void this limited warranty.

If your dealer is unable to resolve your warranty claim or you would like to first notify us of your warranty claim, please contact us as follows:

Taxa Inc., 1830 West 15<sup>th</sup> Street, Houston TX 77008, Tel: 713.861.2540, and Email: [hello@taxaoutdoors.com](mailto:hello@taxaoutdoors.com). Please also visit our website [www.taxaoutdoors.com](http://www.taxaoutdoors.com) for any updated contact information.



#### SOLE AND EXCLUSIVE REMEDY

TO THE MAXIMUM EXTENT PERMITTED BY LAW, THIS LIMITED WARRANTY AND THE REMEDY EXPLAINED HEREIN ARE EXCLUSIVE AND IN LIEU OF ALL OTHER WARRANTIES, REMEDIES AND CONDITIONS, WHETHER ORAL OR WRITTEN, EXPRESS OR IMPLIED. TO THE MAXIMUM EXTENT PERMITTED BY LAW, TAXA INC. SPECIFICALLY DISCLAIMS ANY AND ALL IMPLIED WARRANTIES, INCLUDING WITHOUT LIMITATION, WARRANTIES OF MERCHANTABILITY AND FITNESS FOR A PARTICULAR PURPOSE. THE FOREGOING DISCLAIMER OF IMPLIED WARRANTIES SHALL NOT APPLY TO YOU OR THE TRAILER IF SUCH DISCLAIMER IS IMPERMISSIBLE UNDER APPLICABLE LAW.

#### WHAT IS NOT COVERED UNDER THIS LIMITED WARRANTY/EXCLUSIONS

This limited warranty does not cover any damage, loss, deterioration or malfunction resulting from any alteration, modification, improper or unreasonable use or maintenance, misuse, abuse, tampering, accident, neglect, exposure to excess moisture, fire, lightning, power surges, and/or acts of nature or God. This limited warranty does not cover any damage, loss, deterioration or malfunction resulting from any repairs attempted by anyone unauthorized by Taxa Inc. to make such repairs, or any other cause which does not relate directly to a defect in materials and/or the workmanship of this unit.

Without limiting any other exclusion herein, Taxa Inc. shall not be liable for any incidental or consequential damages, including but not limited to travel, transportation, and lodging expenses, loss or damage to personal property, loss of use, inconvenience or loss of income whenever allowable under state law. Damages for any failure to successfully repair or replace any defect in accordance with this limited warranty shall be limited to the reasonable cost of such repair or replacement as of the time of the alleged failure or defect. This exclusion of consequential and incidental damages shall be deemed independent of, and shall survive, any failure of the essential purpose of this limited warranty.

THE FOLLOWING NUMBERED LIST (1 THROUGH 24) IS NOT EXHAUSTIVE AND DOES NOT LIMIT ANY OTHER EXCLUSION OR LIMITATION DISCUSSED HEREIN OR PERMITTED BY APPLICABLE LAW. THIS LIMITED WARRANTY SHALL NOT COVER NOR APPLY TO:

- (1) Items not manufactured, installed or sold by Taxa Inc., whether warranted separately or not by their respective manufacturers, including but not limited to, tires, batteries, fuses, ac units, heaters, refrigerators, porta-potty's, roof racks, generators, structural and other modifications, and all other such equipment, products, accessories, components, parts, add-ons, appliances, and attachments;
- (2) Trailers used for and/or damage or loss arising from business, rental, commercial, residential, or disaster relief purposes/uses, and/or any non-recreational purpose/use;
- (3) Trailers not originally sold through an authorized Taxa Inc. dealer;
- (4) Trailers sold through auction, repossession, salvage or in an otherwise "distressed" condition, etc.;
- (5) Damage or loss caused in whole or in part by the acts or omissions of any kind by any party other than Taxa Inc., its agents, representatives or employees;
- (6) Damage or loss caused in whole or in part by misuse, abuse, neglect, theft, vandalism, product modification, improper owner, customer or dealer installation, incorrect line voltage, unauthorized repair or failure to properly maintain and/or to follow instructions in accordance with this manual. In particular but not limited to, damages from failure to regularly check, inspect and maintain sealants and seals around roof penetrations, attachments, windows, doors, joints, and seams shall not be covered under this limited warranty;
- (7) Routine/normal maintenance and service items including without limitation, caulking, re-caulking and waxing of the body of the trailer, tightening screws, brakes, latches, locks, changing fuses, or light bulbs, maintaining the batteries, air conditioning, heating, plumbing and electrical systems, lubricants, sealant and seals, etc., and/or damages resulting from lack of proper maintenance and servicing;
- (8) Adjustments to all doors, drawers, locks, latches, slide-outs, awnings and window treatments after ninety (90) days of the date of the original retail sale;
- (9) Damage or loss caused in whole or in part by unauthorized attachments, modifications or alterations to the structure, body, pin box, or frame of the unit including but not limited to trailer hitches, or platforms for supporting cargo;
- (10) Normal deterioration due to wear or exposure such as but not limited to upholstery damage, fading of fabrics, drapes, carpet wear, tears, punctures, dents and/or scratches to the exterior from the roadway, hanging branches, etc.;
- (11) Damage or loss caused in whole or in part by the overloading or the improper balancing/distribution of the load;





- (12) Damage or loss caused in whole or in part by the willful or negligent acts of the driver of the tow vehicle, an accident involving the trailer, the condition of any road surface over which the trailer is pulled, or the striking or driving over or through a curb or any other object;
- (13) Damage or loss to the trailer caused in whole or in part by the tow vehicle including but not limited to the improper selection or installation of towing hitch and hitch assembly on the tow vehicle;
- (14) Any injury, loss or damage due to mold, bacteria or fungi;
- (15) Damage or loss caused by or arising from the operation, use, or misuse of the tow vehicle;
- (16) Any and all damage or loss to the tow vehicle;
- (17) Damage to electronics due to voltage issues;
- (18) Representations made by any person (including your dealer) beyond those stated in this Limited Warranty;
- (19) Any incidental and consequential damages or loss, and extra expenses including, but not limited to, transportation generally, transportation to and from dealer or authorized service center or manufacturing location, loss of time, loss of pay, loss of use of the trailer, inconvenience, commercial loss, towing charges, bus and taxi fares, vehicle rental, telephone calls, fuel, food, lodging, etc.;
- (20) Damage caused by or related to: (a) Accidents, misuse, recklessness, indifference, or negligence; (b) Failure to comply with instructions contained in this Owner's Manual or any other manual related to your unit; (c) Alteration, change or modification of the trailer or damage incurred resulting from alteration, change or modification; and (d) exposure to natural atmospheric elements or environmental conditions, chemicals, ash or fumes generated or released by vehicles or any other item, collision, road hazards, rock chips, condensation, or any other source (salt, hail, Acts of God, etc.);
- (21) Damages related to moisture, condensation, mold, saturation or water;
- (22) damages to your cargo or tow loads;
- (23) damages resulting from or related to the use of your trailer in extreme weather conditions as defined in the "severe weather use" section of this manual.
- (24) any item not specifically listed in the coverage paragraphs of this section.
- (25) any water leaks or related consequential damages that are a result of owner's failure to properly maintain the exterior seals. Any water leaks or related consequential damages that arise after the limited one year warranty expires (water leaks are not considered structural warranty).

#### APPLIANCES/COMPONENT PARTS/ACCESSORIES

Be advised that the manufacturers of some, if not all, of your trailer's appliances, component parts, add-ons and accessories will offer you their own separate warranties. Such wholly separate, additional warranties, if any, are administered directly from and are the sole responsibility of the manufacturer of the specific component part or appliance. Taxa Inc. has no responsibility nor does it have any obligation related to these wholly separate, additional warranties, if any.

You are solely responsible for timely completing and forwarding warranty forms and registrations, and the proper processing of all warranty claims for all components, add-ons, and appliances installed in your trailer. Failure to do so may result in loss of warranty coverage by the component or appliance manufacturer. Note: upon your request, Taxa Inc. may, in its sole discretion, reasonably assist you in the processing of such separate warranty.

#### LEGAL CONSIDERATIONS

*Choice of Law* . . . to the maximum extent permitted by Law, the laws of the State of Texas shall apply to the terms of this Manual and Limited Warranty, and any and all disputes arising out of any limited warranty claim or the purchase or repair of your trailer.

*Venue* . . . to the maximum extent permitted by law, Houston, Harris County, Texas shall be the proper venue for any suit filed by you arising out of any limited warranty claim or the purchase or repair of your trailer.

*Mediation* . . . to the maximum extent permitted by law, a mediation by and through an agreed upon mediator shall be conducted prior to the filing of any suit by you arising out of any limited warranty claim or the purchase or repair of your trailer.



NOTES