

# woollybear owner's manual

**2018**



# HEADS UP!

- 1** The smaller your trailer is the more important proper loading becomes. Ensure that between 10 – 15% of the loaded trailers weight is on the tongue for best handling.
- 2** Check Wheel Lugs: On your first trip tighten wheel lugs at start and at 10, 25, and 50 miles. Thereafter, check wheel lugs before each trip, after excessive breaking and following winter. Always tighten to the manufacturer’s specification of 90 ft. lbs.
- 3** Before driving, make a habit of locking all compartment doors, checking straps and load hold downs.
- 4** Keep an eye out – make a habit of walking around your trailer before you set out, when filling up at a service station, when hitching up at the campground. Preventative maintenance is always the best.
- 5** Have fun!



## WELCOME TO the 2018 Woolly Bear!

Congratulations on your new Woolly Bear!

We want you to go on adventures.

This one is not an RV (you cannot get inside it. Please do not try to get inside it!).

How about AV (adventure vehicle)?

How about PTV (personal transformation vehicle)?

How about hitting the road?

Please have a great time. Please support our nations' park systems. It takes work to keep things wild. Please find a National Forest and say hi to nature.

Please take what you need and leave nothing behind! Keep everyone else's adventures pristine. We wholeheartedly support the teachings of Leave No Trace. We support Leave No Trace and think you might want to as well ([www.lnt.org](http://www.lnt.org)).

Please be safe!

*It is important that you thoroughly review this Owner's Manual. Please also consult it anytime you have a question regarding the use, operation and maintenance of your trailer, and its systems and components. Your Woolly Bear trailer has multiple systems, parts, and components, and understanding how they work is an important part of having a fun, safe travel experience.*

We want your first and every adventure to be great. Have a practice session in your driveway. Hitch that trailer up and drive it around the block. Get comfortable. Ask questions! Get answers to any questions, issues or problems that arise during your practice. Get answers from your friends at your dealer or taxa, or maybe your neighbor. Give us a call or email us at [hello@taxaoutdoors.com](mailto:hello@taxaoutdoors.com). Many questions can be answered quickly and easily and save you a lot of hassle.

We hope you enjoy many years of great memories and outdoor adventure.

Sincerely,

A handwritten signature in black ink, appearing to read "Garrett Finney". The signature is fluid and cursive, with a large loop at the end.

Garrett Finney,  
TAXA Founder



## **YOUR OWNER'S MANUAL (AND OTHERS)**

Please consider this Owner's Manual a permanent part of your trailer, keeping it with the trailer at all times including if and when you sell it. Keep the manuals, stickers and tags associated with your trailer's items, add-ons, appliances and equipment in the trailer as well.

This manual is not intended to be inclusive of every operational aspect of your unit. It should be utilized and referenced by you in conjunction with the separate, additional manuals provided by the manufacturers of the different components, component parts, appliances, add-ons, systems, and accessories in your unit. Your unit will contain any such manuals provided to Taxa Inc. by the specific component part, appliance, add-on, system, and accessory manufacturer. Please read them to gain a more complete understanding of the operation and maintenance of the products and appliances installed in your trailer.

**READ THE ENTIRE MANUAL AND OBEY ALL CAUTION, WARNING, DANGER AND OTHER SAFETY-RELATED STATEMENTS PRIOR TO OPERATING YOUR TRAILER.**

### **please note**

This Owner's Manual contains the most up-to-date product information available at the time of publication. However, due to continuous product development, innovation and improvements, Taxa Inc. reserves the right to make changes in production techniques/processes, product materials, product specifications and components. Such changes may be made without prior notice or any obligation upon Taxa Inc. to make corresponding changes or improvements in or upon its already manufactured, installed and/or sold trailers and/or products. Please visit our website at [www.taxaoutdoors.com](http://www.taxaoutdoors.com) to check for manual updates and our current manual.



**Table of Contents**

WELCOME TO the 2018 Woolly Bear! ..... 3

YOUR OWNER’S MANUAL (AND OTHERS) ..... 4

SAFETY TERMS..... 6

OVERVIEW OF SAFETY PRECAUTIONS..... 7

HITCHING..... 8

LOADING ..... 10

TOWING..... 12

BRAKES..... 14

TIRES..... 14

WOOLLYBEAR DESCRIPTION ..... 17

ELECTRICAL SYSTEM..... 26

BATTERY ..... 28

PRE-TRAVEL CHECKLIST ..... 29

SITE SELECTION AND SET UP ..... 31

FOUR SEASON USE / EXTREME WEATHER..... 32

GENERAL CARE AND MAINTENANCE..... 33

STORAGE, WINTERIZATION & BRINGING OUT OF STORAGE ..... 34

TROUBLESHOOTING ..... 35

LIST OF AUTHORIZED DEALERS ..... 35

your LIMITED WARRANTY..... 36



## **SAFETY TERMS**

We have included various safety messages in this manual, all of which are important. Please read and obey them. The following are safety-related terms and symbols referred to in this manual and their corresponding meanings/definitions:

DANGER indicates an imminently hazardous situation that, if not avoided, will result in death or serious injury.

WARNING indicates a potentially hazardous situation that, if not avoided, could result in death or serious injury.

CAUTION indicates a potentially hazardous situation that, if not avoided, may result in minor or moderate injury.

NOTICE is used to address practices not related to personal injury. This applies to hazardous situations involving property damage or important information regarding the maintenance of your vehicle.



## OVERVIEW OF SAFETY PRECAUTIONS

You'll find various safety-related references, discussions and instructions throughout this owner's manual, and all of them are important. This overview is not an exhaustive list of the safety issues discussed or contemplated in this manual. Please carefully read and follow all safety issues discussed in this manual. If you have any questions regarding trailer safety issues, please contact your dealer and/or Taxa Inc.

The following is a broader snapshot of a few of the more common safety instructions/discussions/issues in the use and operation of your new trailer:

- Be sure load/cargo weight does not exceed your GVWR and that weight is distributed properly before travel. Please refer to the "Loading" section.

- *fully close-up and lock your trailer before towing ...* to ensure efficient and safe transportation.

- Be sure safety chains and breakaway switch have been properly attached and secured as part of your hitching up process.

- *tires ... be vigilant in your tire inspection and maintenance.* Properly maintained tires improve the steering, stopping, traction, and load-carrying capability of your trailer and tow vehicle. Under-inflated tires and over-loaded vehicles are major causes of tire failure. Please refer to "Tires" section for a more detailed discussion on your tires and tire safety.

- Be sure all electrical uses and activities involve proper grounding.

- *reduce fishtailing & sway ...* excessive sway of your travel trailer can lead to the rollover of the trailer and tow vehicle resulting in serious injury or death. This usually due to incorrectly loading the trailer but can also indicate road conditions or trailer damage. You may choose to install a separately purchased sway control device to help reduce sway. Be sure to contact your dealer if you have any questions regarding sway control device alternatives. Please also refer to the sway and fishtailing discussion in the "Towing" section.

- *lug nut torque ...* be sure wheel mounting nuts (lug nuts) on trailer wheels are tight and properly torqued. Inadequate and/or improper wheel nut torque (tightness) is a major reason that lug nuts loosen. Loose lug nuts can rapidly lead to a wheel separation with potentially serious safety consequences. Refer to a qualified technician before travel if you have any questions regarding your wheel nut torque. See also "Tires" section.

- *appliances and equipment ...* some camping equipment (portable stove, portable furnace, etc.) operate on propane. Propane is highly flammable and contained under high pressure. Improper use may result in a fire and/or explosion. Be sure to follow the instructions and warnings provided by the manufacturer of such appliances, if any.

## HITCHING

Our trailers require a 2" diameter hitch ball. *Use of any other hitch ball diameter size will create an extremely dangerous condition that can result in separation of the coupler and ball, and/or hitch ball failure.* Other than this crucial 2" diameter requirement, there are numerous trailer hitches and hitching components available to you for your trailer. Be sure to consult your tow vehicle manufacturer for hitch and/or hitch assembly alternatives.

*pre-hitch/coupling/trip considerations and inspection ....* be sure your hitch and tow vehicle are rated for the Gross Vehicle Weight Rating (GVWR) of your trailer. Remember that the hitch load rating must be equal to or greater than the coupler load ( one is attached to car, other to trailer). Be sure the hitch size matches the coupler size.

Examine all hitch components before hitching, looking for wear, corrosion, deformations, stripping and cracks. Replace worn, corroded or cracked hitch components before coupling the trailer to the tow vehicle. Be sure the hitch components are tight and that the ball-locking device works freely before coupling the trailer to the tow vehicle. Remember to also inspect the safety chains. Be sure to correct any noted problems or defects before towing the trailer.

Other Important Note: be sure to raise all trailer jacks and close the trailer fully before hitching (i.e. close all hatches).

Your trailer is equipped with a 7-pin connector, which synchronizes the lights of your tow vehicle and trailer, and can charge the battery on your trailer while driving. Your WoollyBear can easily and safely be towed using a 4-pin connection. For this usage simply purchase an adapter at most auto part stores.

**WARNING: THE PROPER SELECTION AND CONDITION OF THE COUPLER AND HITCH IS ESSENTIAL TO THE SAFE TOWING OF YOUR TRAILER. A LOSS OF COUPLING MAY RESULT IN DEATH OR SERIOUS INJURY.**

**WARNING: AN IMPROPERLY COUPLED TRAILER CAN RESULT IN DEATH OR SERIOUS INJURY.**

**WARNING: USE OF A TOW VEHICLE WITH A TOWING CAPACITY LESS THAN THE LOAD RATING OF THE TRAILER CAN RESULT IN LOSS OF CONTROL, AND MAY LEAD TO DEATH OR SERIOUS INJURY.**

Hitching up your trailer will get easier with practice. The hitching steps described below are typical. However, we highly recommend that you also consult the hitching and unhitching instructions associated with your particular tow vehicle and hitching co

*hitching steps and instructions:*



(1) crank the tongue of the trailer jack until the hitch coupler is raised enough to clear the tow vehicle;

(2) back the tow vehicle to the trailer until the hitch ball is directly under the trailer coupler. The use of a backing aid mirror may be helpful, especially if you are hitching alone;

(3) set the parking brakes;



(4) be sure the coupler latch-locking lever is fully open, and then lower the tongue jack until the ball is firmly seated in the socket;

(5) close the coupler latch and secure it with a locking pin or bolt (*you can use the pin that locks the caster wheel on to the front jack*);

(6) securely attach the safety chains in a crossing pattern to the tow vehicle and confirm that they are properly connected to the trailer. Do not fasten chains to any part of the hitch unless the hitch has holes or loops designed specifically for that purpose, be sure the chains do not drag during towing.;

**WARNING: IMPROPER RIGGING OF THE SAFETY CHAINS CAN RESULT IN LOSS OF CONTROL OF THE TRAILER AND TOW VEHICLE, LEADING TO DEATH OR SERIOUS INJURY, IF THE TRAILER UNCOUPLES FROM THE TOW VEHICLE.**

(7) connect the power cord between the tow vehicle and the trailer, leaving enough slack for the tow vehicle to turn without disconnecting the power cord;



trailer wiring plugged securely into tow vehicle, lights tested

coupler securely latched and pinned

chains crossed and securely attached to frame of hitch

(8) adjust side mirrors;

(9) check all lights on trailer and tow vehicle, ensuring that they are communicating properly; and

**FOLLOW ALL INSTRUCTIONS PROVIDED BY YOUR VEHICLE'S TOW PACKAGE MANUFACTURER AND/OR INSTALLER.**



## LOADING

The process of safely and properly loading your trailer should become easier with practice and experience. Please first get familiar with and understand the following terms related to your trailer's weight, carrying capacity, and rating:

*gross vehicle weight rating (GVWR)* is the maximum permissible weight of the trailer when fully loaded and equipped/outfitted. It includes but is not limited to all weight at the trailer axle(s) and tongue or pin as well as all add-ons, appliances, accessories, potable water, etc. Your trailer's GVWR is 1400 lbs. Please refer to the sticker located at the front exterior of your trailer for GVWR.

*unloaded vehicle weight (UVW)* is the weight of the trailer as manufactured at the factory (standard weight). It includes all weight at the trailer axle(s) and tongue or pin. Your trailer's standard UVW is approximately <850 lbs. However, you will need to account for the weight of dealer or third-party installed add-ons, options and accessories, if any, in determining your actual UVW. In sum, your actual UVW will vary (and increase) to the extent you have outfitted your trailer with additional items. Note: Your cargo carrying capacity (discussed below) will vary (and decrease) to the extent of the weight of dealer or third-party installed add-ons, options and accessories, if any.

*cargo carrying capacity (CCC)* is equal to GVWR minus UVW and potable water weight. Your trailer's CCC is approximately 600 lbs. However, remember that your actual CCC will vary (and decrease) to the extent you have outfitted your trailer with additional items. Please refer to the stickers located at the front exterior of your trailer for CCC.

*gross axle weight rating (GAWR)* is the value specified as the load carrying capacity of a single axle system, as measured at the tire-ground interfaces. Your trailer's GAWR is 1400 lbs. Please refer to the sticker located at the front exterior of your trailer for GAWR.

*gross trailer weight (GTW)* is the weight of the trailer with all the items and supplies that are loaded into the unit at any point in time.

### WEIGHT GENERALLY

Before towing, you must choose the items you will load onto your trailer and then determine whether the loaded weight is safe and proper. Of course, the best way (highly recommended) to calculate the loaded weight of your trailer is to have it weighed while loaded, and then compare it with the GVWR (1400 lbs.). Otherwise, you will need to do some calculations on your own in order to make an appropriate determination. If the loaded weight of your trailer exceeds the GVWR, your trailer is overloaded and should not be towed. You will need to remove items from, and reduce the loaded weight of, the trailer until it's at or below the GVWR before towing. Note: remember to include in your calculations the weight of dealer or third-party installed equipment, options, add-ons, accessories and any other non-standard items. *As an additional safety precaution, we recommend that you take a conservative approach when doing your own weight calculations.*

### WEIGHT/LOAD DISTRIBUTION AND TONGUE WEIGHT

Proper weight and load distribution is also essential to safe towing. Load the trailer evenly (front to back and side to side) and securely, keeping heavier items as low as possible. Be sure to secure the load. A firmly secured load will be less prone to shifting and should help maintain load balance during travel.

Your WoollyBear can be loaded in many many different ways. This flexibility should allow you to distribute the weight effectively and safely. For instance you can choose the placement of Jerry cans full of water, or the placement of a rooftop tent mounting towards the front or the rear of the cargo deck.

Tongue (the trailer arm extension that couples with the tow vehicle receiver) weight is the amount of weight borne by the trailer hitch and another important consideration when loading your trailer. Generally, the actual tongue weight should equal approximately 10-15% of the gross trailer weight. Excessive tongue weight will make your tow vehicle's steering less responsive. Insufficient tongue weight may cause your trailer to sway.

You could weigh your loaded trailer's tongue to determine the actual tongue weight. However, you may also observe the actual tongue weight and determine if it is too light or too heavy. For example, a trailer with a proper tongue weight will form a straight line from front to back between the tow vehicle and the trailer. A trailer with the weight improperly distributed (i.e. a light tongue weight) will cause the coupling between the tow vehicle and trailer to rise, with the weight pressing down at the rear of the

trailer and the front of the tow vehicle. Excessive tongue weight will do just the opposite.

If you notice a rise or fall in your tow coupling, you will need to redistribute the weight of the load before getting on the road. If you have trouble estimating the combined weight of your trailer plus cargo, take your loaded trailer to a vehicle scale at a nearby weigh station or truck stop. *Important Note: you need to also refer to your tow vehicle's towing capacity and other towing and load capacity-related definitions and instructions before getting on the road. Please also consult your supplying dealer or Taxa Inc. if you have any questions regarding these terms and/or loading your trailer.*

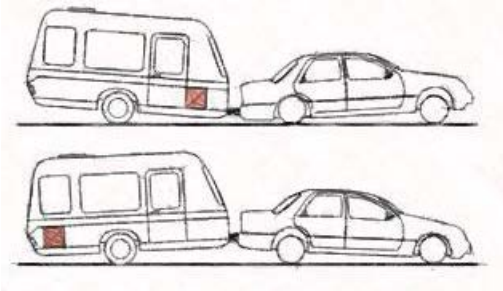

example of poor weight distribution



proper ~10 to 15% of loaded trailer on tongue



## TOWING

We want your towing experiences and practices to be safe and enjoyable. Please take your time, avoid being in a rush and give special attention to all safety matters prior to and during the towing of your trailer.

As previously indicated, we recommend that you practice towing your WoollyBear in, for example, an empty parking lot before going on your first camping trip. This initial trial and practice is fun and will help you get accustomed to and familiar with WoollyBear's systems and operation. Please also make note of any questions, issues or problems that arise during your pre-travel towing practice, and then inquire with your dealer or email us [hello@taxaoutdoors.com](mailto:hello@taxaoutdoors.com). You can also visit our website ([www.taxaoutdoors.com](http://www.taxaoutdoors.com)) for current contact information. Please also refer to the "Overview of Safety Precautions" and "Pre-Travel Checklist" sections before towing your trailer.

*safety chains ...* We have equipped your trailer with safety chains. Make use of them. Safety chains serve to maintain the connection between your trailer and the tow vehicle in the event of separation of the ball and trailer coupling. Be sure to hook the safety chains to the frame of the tow vehicle (not the hitch), crossing them under the trailer's tongue. Also, remember to inspect the length of the chains once they are attached to the tow vehicle frame. A proper chain length will allow turns and prevent the chains from dragging on the road. A quick and easy way to adjust the lengths of chain is to simply twist them before mounting them to the tow vehicle.

*tire pressure ...* you are responsible for maintaining proper tire pressure in the tires of your trailer and tow vehicle. Thus, always check your tire pressure and refer to the "Tires" discussion herein before traveling.

*brakes ...* you are responsible for inspecting and maintaining both your trailer and tow vehicle brakes before towing. Do not tow your trailer unless you have confirmed your brakes are in good condition and operating properly. Be sure to have a qualified technician perform all brake adjustments, service and maintenance. Please also refer to the "Brakes" discussion herein before traveling.

*lights ...* be sure to check all electrical connections to ensure all lights on the tow vehicle and trailer are functioning properly before traveling. The brake lights, and hazard and turn signals should be in synchronization with the tow vehicle.

*stay level ...* the trailer and tow vehicle must be level when hitched. Dragging may occur if the hitch is too low. Conversely, if the hitch is too high, the rear of the trailer is exposed to striking higher points in the road.

*general towing/driving ...* drive defensively, anticipating stops, braking early, and never following closely. We recommend maintaining a length of at least three cars and a trailer (approximately 65 ft.) between you and the car in front of you for every 10 mph of speed you are traveling (for example, at 60mph, you should maintain approximately 390 ft. of distance between your vehicle and the vehicle in front of you). This should give you adequate time to safely complete a proper avoidance maneuver (i.e. come to a safe stop, change lanes, etc.) in the event of, for example, an abrupt stop or emergency.

Longer stopping distances are required when towing a trailer so remember to start braking sooner than you would if driving without your trailer. Begin slowing down well in advance of anticipated street/road dips and depressions. It also takes longer to accelerate when towing a trailer. Thus, remember to account for both the slower acceleration rate and the combined length of your tow vehicle and trailer when passing another vehicle and then safely returning to your lane. In sum, always pass, allow others to pass, and change lanes with care. We also do not recommend using cruise control or overdrive when towing/travelling.

*SWAY AND FISHTAILING ...* excessive sway or fishtailing of your trailer can lead to the rollover of the trailer and tow vehicle, and thus, serious injury or death. The tendency for the vehicle to sway increases with speed. Thus, reduce speed as needed and in inclement or harsh weather conditions (i.e. high winds, rainstorms, slippery roads, etc.). The following are a few tips for reducing sway or fishtailing if and when they occur and are not exhaustive: (1) *slow down gradually ....* do not jam/slam on the brakes or press on the accelerator, both of which may make the situation worse and result in severe injury or death. Instead, remove your foot from the accelerator and reduce your speed gradually whenever possible; (2) *minimize and avoid quick steering movements ....* Quick steering movements will actually cause increased sway and loss of control; Keep both hands on the wheel, and hold the wheel as straight as possible until stability is regained; and (3) *As soon as practicable after regaining control ...* pull over and check tire pressures and cargo weight distribution, and inspect the trailer and tow vehicle for any signs of failure or defect. If you suspect a mechanical failure, recommend that you not tow until



the problem is identified and remedied. If you choose to travel, do so at reduced speeds and with heightened caution until the problem can be identified and remedied.

**WARNING:** Side to side motion (sway) that begins as you reach a certain speed will likely become whipping at higher speeds. As soon as you notice sway, slow your vehicle by letting off the gas pedal. Then stop to check the trailer and tow vehicle as soon as it is safe to do so.

#### **OTHER IMPORTANT TOWING SCENARIOS**

*winding, narrow roads ...* stay in the center of the lane. This reduces the likelihood of the tires/wheels dropping onto the shoulder, another potential cause of hazardous sway. Do not cross the center-line unless safely changing lanes.

**WARNING:** If a wheel goes off the paved roadway, do not steer sharply and do not brake. Let off the gas pedal, slow down below 25 mph and then steer gradually back onto the roadway. Proceed with caution entering traffic.

*sharp turns ....* minimize the suddenness of sharp turns by anticipating them, slowing down well in advance of them, and taking them at low, substantially reduced speeds.

*steep, long grades ... like sharp turns, be sure to anticipate steep grades.* Down-shift into a lower gear or range in advance to assist your braking on a descent and to add power on a climb.

Note: avoid situations that require excessive and prolonged use of the brakes. If unavoidable, apply and release brakes at short intervals to give them a chance to cool. Downshift your tow vehicle to reduce breaking needs on long down grades of highway.

*slippery, icy pavement ...* reduce speed and drive slowly. Remember that skidding/hydroplaning can occur with minimal moisture on the road. If skidding occurs, remove your foot from the accelerator and then gently apply the trailer brakes only.

*freeways and highways ...* try to pick and stay in the far right hand slow(er) lane.

*corner turns ...* trailer wheels do not follow the path of your tow vehicle's wheels during corner turns. The trailer will make a closer, tighter turn than the tow vehicle. Compensate by moving further into the intersection before turning so that the trailer clears any objects in or near the road such as but not limited to the curb and parked vehicles. Left turns require a wider than normal turn to help prevent the trailer from edging into an opposing lane. Use turn signals early for the traffic behind you and begin slowing down well in advance of your turn.

*mud and sand ...* when going through mud or sand, accelerate gently, if at all, and try to remain in the path of the previous vehicles. Let the momentum of the tow vehicle and trailer carry you through the problem area. If stuck, the trailer and tow vehicle should be towed out while hitched.

*dirt, gravel, washboard roads ...* go slow, use caution, your trailer will move and vibrate more than the tow vehicle, a good rule of thumb is 25 mph or less, MUCH less on severely rutted roads.

*parking ...* Whenever possible, avoid parking on a grade. If unavoidable, turn the front wheels of your tow vehicle into the curb and set the parking brake. For added safety, place wheel chocks under the trailer wheels.

*additional towing safety information ...* can be found on the National Highway Traffic Safety Administration's web site:<http://www.nhtsa.dot.gov/Cars/problems/Equipment/towing/Towing.pdf>

## BRAKES

*overview* .... although not required in every State, we have equipped your trailer with electric brakes. *Under normal driving/towing conditions,*

## TIRES

*if size: ST 205/75 R 15 pressure: 50psi cold*

*size: LT 215/75 R 15 pressure: 65psi cold*

*overview...* Properly maintained tires improve the steering, stopping, traction, and load-carrying capability of your vehicle. Under-inflated tires and overloaded vehicles are a major cause of tire failure. **Maintaining proper tire pressure, tire and vehicle load limits, avoiding road hazards, and regularly inspecting tires for cuts, slashes, and other irregularities are important steps in avoiding tire failure, such as tread separation or blowout and flat tires.** These steps, along with other care and maintenance activities, may improve vehicle handling, help protect you and others from avoidable breakdowns and accidents, improve fuel economy and increase the life of your tires. In sum, you are responsible for making tire safety a regular part of your tow vehicle and trailer maintenance routine. Remember that the time you spend is minimal compared with the inconvenience and safety consequences of tire failure.

*proper wheel nut torque* is essential to safe towing. The wheel and axle systems used in trailers are similar in many ways to those found in motor vehicles. However, they differ in several important ways. First, trailer wheels do not steer, and are subjected to high side load stress when making tight turns around corners. This tends to flex the wheel and loosen the wheel nuts. Wheel nut torque requirements vary depending on the size and manufacturer of the wheel.

### TIRE FUNDAMENTALS

Federal law requires tire manufacturers to place standardized information on the sidewall of all tires. This information identifies and describes the fundamental characteristics of the tire and also provides a tire identification number for safety standard certification and recall matters.

*Sidewall markings and important terms* ... your trailer tires should be marked with either a designation of "ST" (i.e. ST205/75/ R15, or LT215/75/R15). The "ST" indicates Standard Trailer Service and designed for trailer use only. The "LT" indicates Light Truck Service and designed to be used on vehicles that are capable of carrying heavy cargo.

*maximum load rating* .... Is the maximum load in kilograms and pounds that the tire can carry.

*maximum permissible inflation pressure* ... is the greatest amount of air pressure that should be put in the tire under normal driving conditions.

*max. load single kg (lbs) at kPa (psi) cold* -This information indicates the maximum load and tire pressure when the tire is used as a single.

*load range* .... identifies the tire's load-carrying capabilities and its inflation limits.

### TIRE TREAD

The tire tread provides the gripping action and traction that helps prevent your vehicle from slipping or sliding, especially when the road is wet or icy. Generally, tires are not safe and should be replaced when the tread is worn down to 1/16 of an inch. *The following chart is a general guide for determining the condition of and maintenance action for your trailer tires:*

*replacement* ... please refer to the tire sidewall on your trailer's standard tires for information regarding proper tire replacement. Be sure to replace your standard trailer tires with "ST" designated tires. Note: replacing your trailer tires with non-ST designated tires will void the Limited Warranty. See Limited Warranty section herein. If you have any doubt about the correct size/type to choose, consult with a tire dealer. Please also refer to the manual provided by your specific tire manufacturer for care and use

instructions.

*repair ....* the proper repair of a punctured tire requires a plug for the hole and a patch for the area inside the tire that surrounds the puncture hole. Punctures through the tread may be repaired if they are not too large, but punctures to the sidewall should NOT be repaired. Tires must be removed from the rim to be properly inspected before being plugged and patched.

**ALL TIRE REPAIRS SHOULD BE PERFORMED BY A QUALIFIED TECHNICIAN.**

#### TIRE PRESSURE AND LOAD LIMITS

Tire inflation pressure is the level of air in the tire that provides it with load-carrying capacity and affects the overall performance of the vehicle. Because tires may naturally lose air over time, or when driven over objects such as potholes or curbs, it is important to check tire pressure monthly and before every trip.

The tire inflation pressure number indicates the amount of air pressure—measured in pounds per square inch (psi)—a tire requires to be properly inflated. Vehicle manufacturers determine this number based on the vehicle's design load limit, that is, the greatest amount of weight a vehicle can safely carry and the vehicle's tire size. Excessive loads may lead to abnormal tire flex, tire overheating, and ultimately, tire failure. As travel trailers may be set up and loaded in varying ways, proper air pressure should be determined by referencing the information on your tire. Please also refer to the Tire and Loading Information sticker located at the front exterior of your trailer.

The proper tire pressure for your vehicle is referred to as the "recommended cold inflation pressure." A "cold" tire in this sense is one that has not been driven on for at least three hours. When you drive, your tires get warmer, causing the air pressure within them to increase. Therefore, to get an accurate tire pressure reading, you must measure tire pressure when the tires are cold or account for the extra pressure in warm tires.

**WARNING:** Improper tire pressure can quickly lead to excessive wear and dangerous situations.

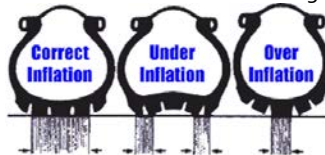

#### *tire pressure steps:*

- Locate the recommended tire pressure on the vehicle's tire.
  - Record the tire pressure of all tires.
  - If the tire pressure is too high in any of the tires, slowly release air by gently pressing on the tire valve stem with the edge of your tire gauge until you get to the correct pressure.
  - If the tire pressure is too low, note the difference between the measured tire pressure and the correct tire pressure. These "missing" pounds of pressure are what you will need to add.
- At a service station, add the missing pounds of air pressure to each tire that is under-inflated.
- Check all the tires to make sure they have the same air pressure (except in cases in which the front and rear tires are supposed to have different amounts of pressure).

#### *remember:*

Do not exceed the maximum recommended pressure.

The air pressure recommended on the tire information placard is for the original standard equipment tires only. Your trailer may be equipped with optional-sized tires. Always follow the pressure recommendations stamped in the tire sidewall for any replacement tire.

Rotate tires every 5,000 miles or as recommended by the tire manufacturer.

#### WHEEL NUT TORQUE ADJUSTMENTS

##### *setting torque value on a dial indicator wrench:*

Make sure your indicator needle is set to "0".

As you apply clockwise pressure to the wheel nut, both needles will show the current amount of torque being applied.

When you reach your desired torque value, stop applying pressure and your indicator needle will stay at the highest torque value reached.

##### *setting torque value of adjustable dial wrench:*



Unlock the handle and set the dial to your desired torque value.  
 Lock the handle back in place.  
 As you apply clockwise pressure to the lug nut, you will hear and audible “click” when the desired torque wrench value is reached.  
 Do not apply further pressure once you hear the “click”.

*pre-trip torqueing procedure:*

Be sure to tighten the wheel nuts and torque to go lbs. Follow the torque sequence and torque table provided next:

Wheel Nut Torque Table

	Wheel
1st Stage	20-25 ft./lb.
2nd Stage	55-60 ft./lb.
3rd Stage	85-90 ft./lb

*stage 1* Set your torque wrench to the 1st stage value on the Wheel Nut Torque Table. Begin with the appropriate bolt for your wheel (12 o'clock position for 8 and 6 hole wheels and 2 o'clock position for 5 hole wheels) and apply torque to all wheel nuts following the star pattern as shown in the Wheel Nut Torqueing Sequence illustration shown here.

*stage 2* Increase your torque wrench setting to the 2nd Stage value on the Wheel Nut Torque Table. Begin with the appropriate bolt for your wheel and apply torque to all wheel nuts following the star pattern. Following stage 2, the wheel can support the weight of the trailer and may be lowered off of the jack stands.

*stage 3* Increase your torque wrench setting to Final Torque value on the Wheel Nut Torque Table. Begin with the appropriate bolt for your wheel and apply torque to all wheel nuts following the star pattern.

*follow-up* If the wheel was replaced, check the torque again at every 50 miles for the first 500 miles and prior to each trip thereafter.

If you notice wheel wobbling or hear a rattling sound coming from a wheel, especially at low speeds, a wheel lug may have come loose. This problem is usually caused by improper tightening or by faulty or damaged lug bolt threads. If you have reason to believe a lug nut has come loose, safely stop the vehicle at the side of the road as soon as possible. Put up warning devices. Remove the lug caps and check the tightness of all the lug nuts. If lug bolt threads are damaged or faulty, get professional services help. Do NOT tow the trailer with missing lug nuts or faulty lug bolts.

**BALANCING, ALIGNMENT AND LUBRICATION**

To avoid vibration or shaking of the vehicle when a tire rotates, the tire must be properly balanced. This balance is achieved by positioning weights on the wheel to counterbalance heavy spots on the wheel-and-tire assembly. A wheel alignment adjusts the angles of the wheels so that they are positioned correctly relative to the vehicle’s frame. This adjustment maximizes the life of your tires. These adjustments require special equipment and should be performed by a qualified technician.

Wheel bearings should be repacked every 6000 miles or every 6 months. Every time the wheel hub is removed, the wheel bearings must be adjusted. Please refer to manufacturer instructions or schedule maintenance with a qualified technician to repack wheel bearings.

**TIRE SAFETY CHECKLIST**

(1) check tire pressure regularly (at least once a month and before any extended trip/travelling), including the spare tires, if any... Note: When checking air pressure, be sure that all tires have both the correct and identical pressure before getting on the road; (2) check and torque wheel lug nuts regularly; (3) inspect tires for cuts, slashes, punctures and other irregularities at least on a monthly basis and before every extended trip/travelling; (4) remove any foreign objects (i.e. pieces of glass or metal, etc.) wedged in the tread; (5) confirm all tire valves have valve caps; (6) do not overload your tow vehicle or trailer; (7) slow down when having to go over a pothole or other object in the road, and avoid running over curbs and other foreign objects in the road and when parking if you can safely do so; (8) Replace tires when tread depth approaches and/or reaches 1/16 of an inch, and (9) have a qualified technician perform tire service, maintenance and adjustments as needed.

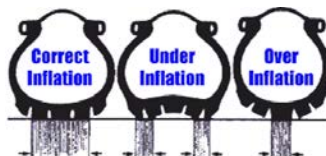



**WOOLLYBEAR DESCRIPTION**

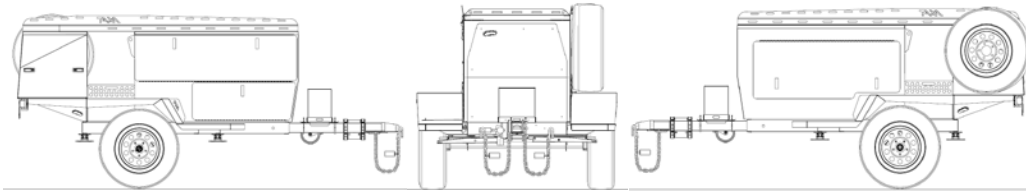

passenger side elevation, front elevation, driver side elevation

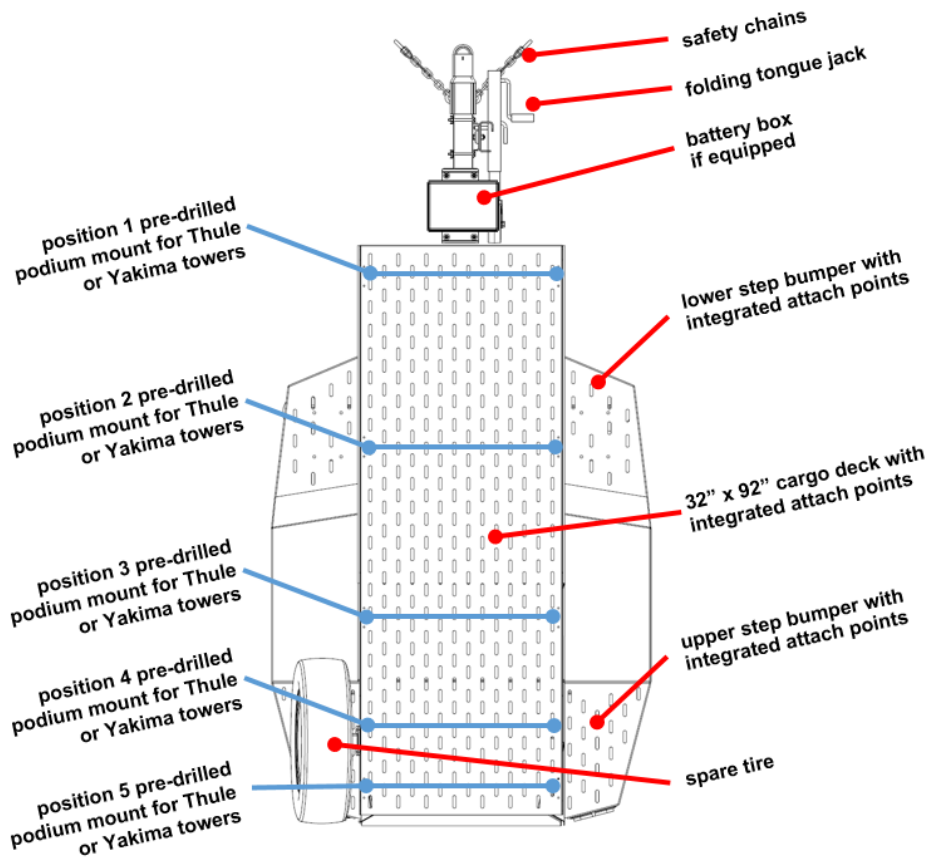

top view

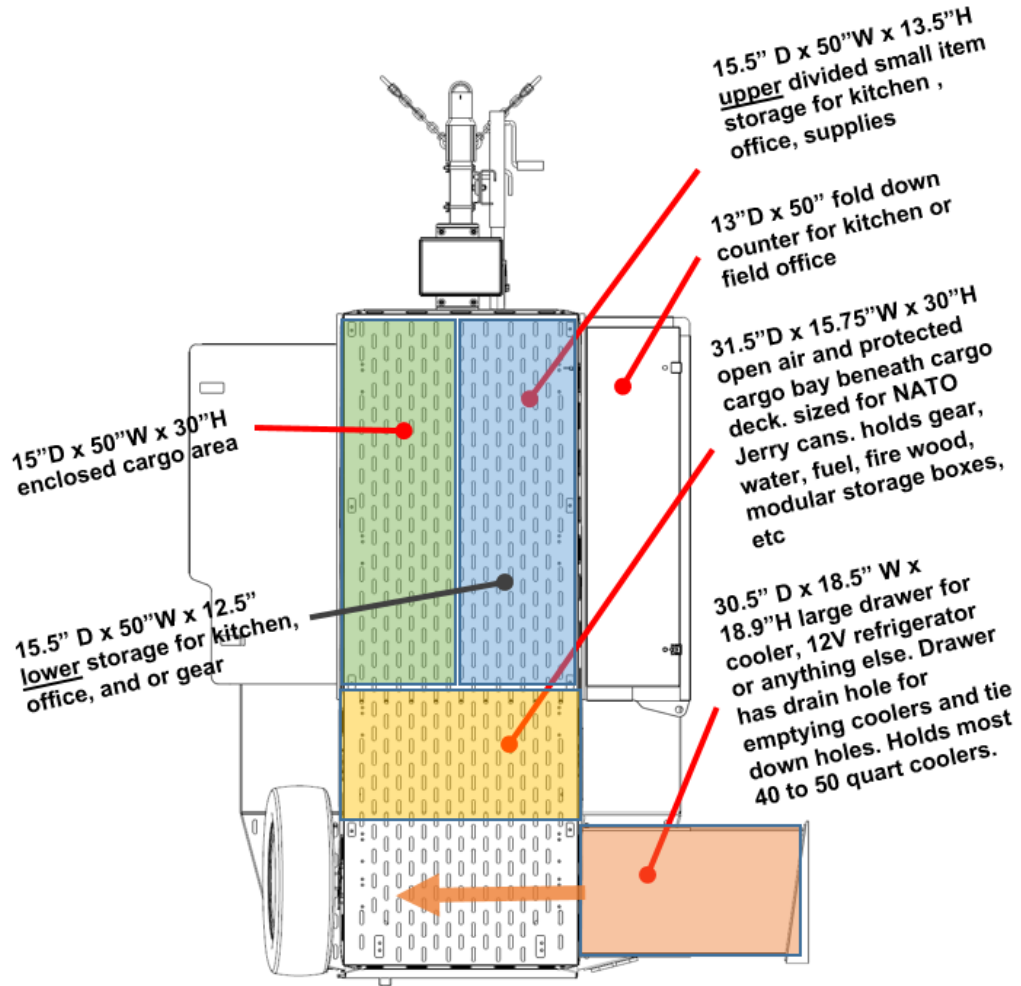

storage overview



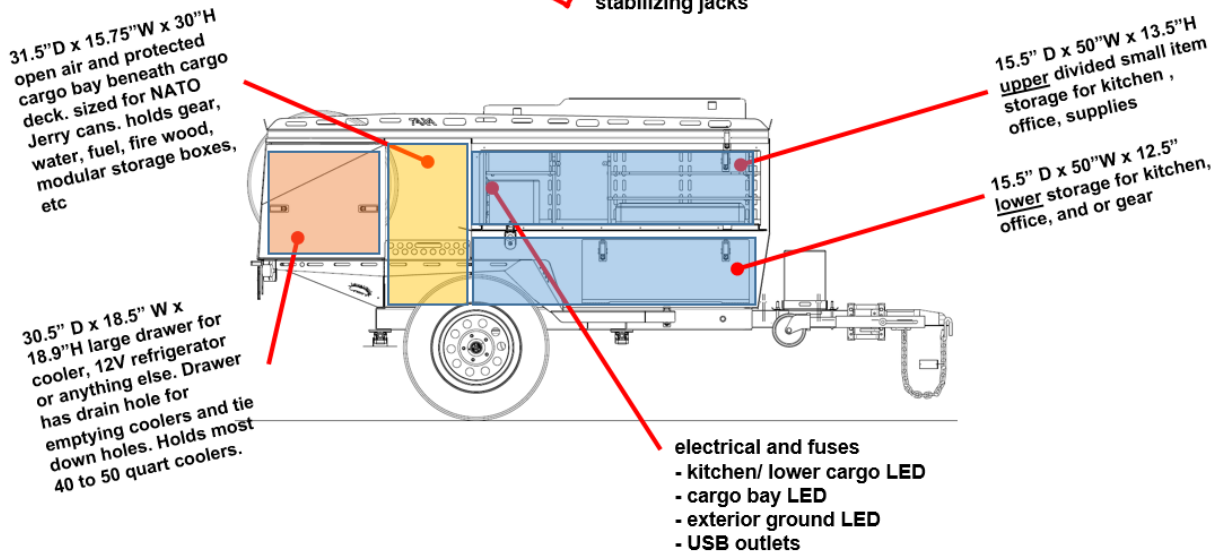
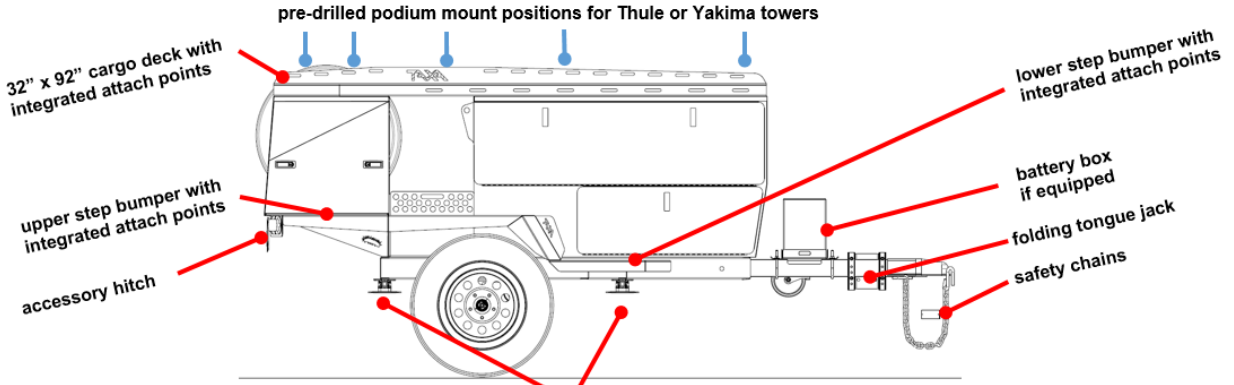

passenger side overview



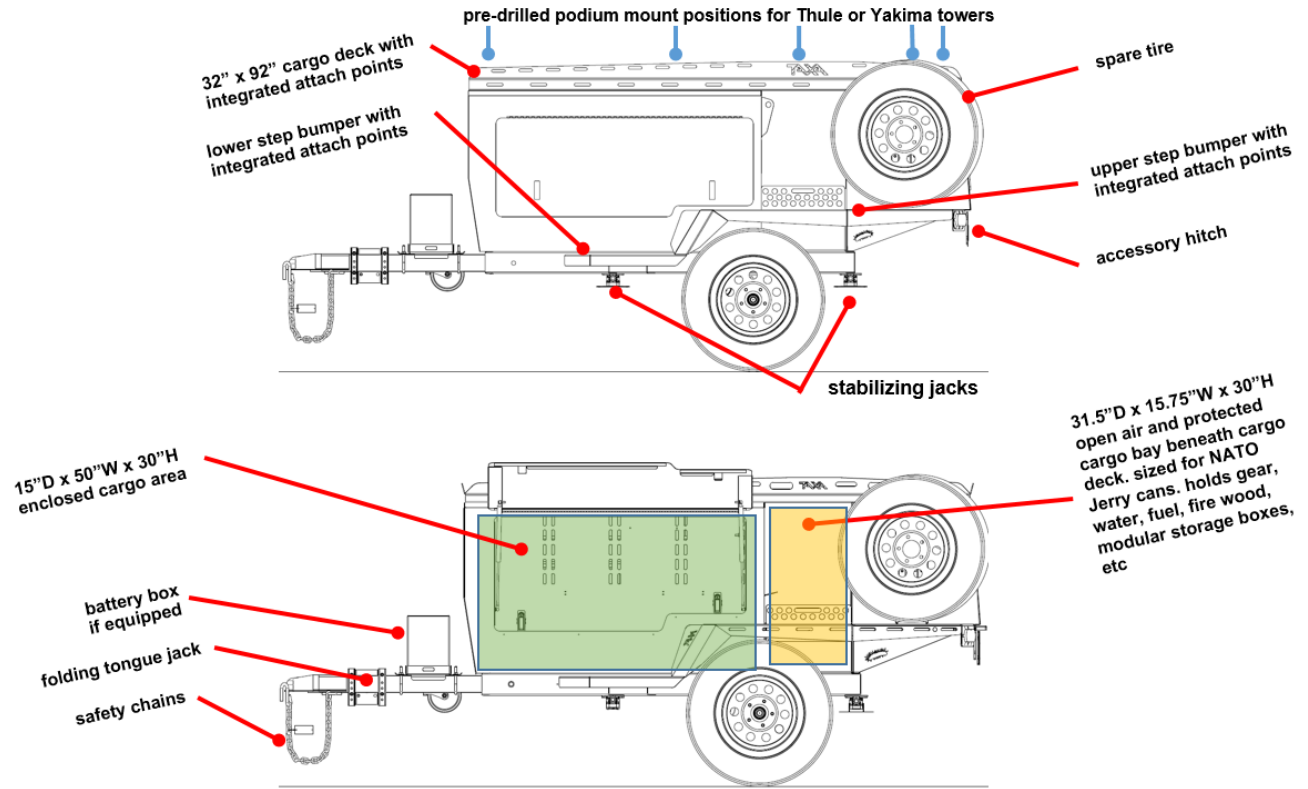

driver side overview



cargo bay – attach points for nets and tie downs, night lighting

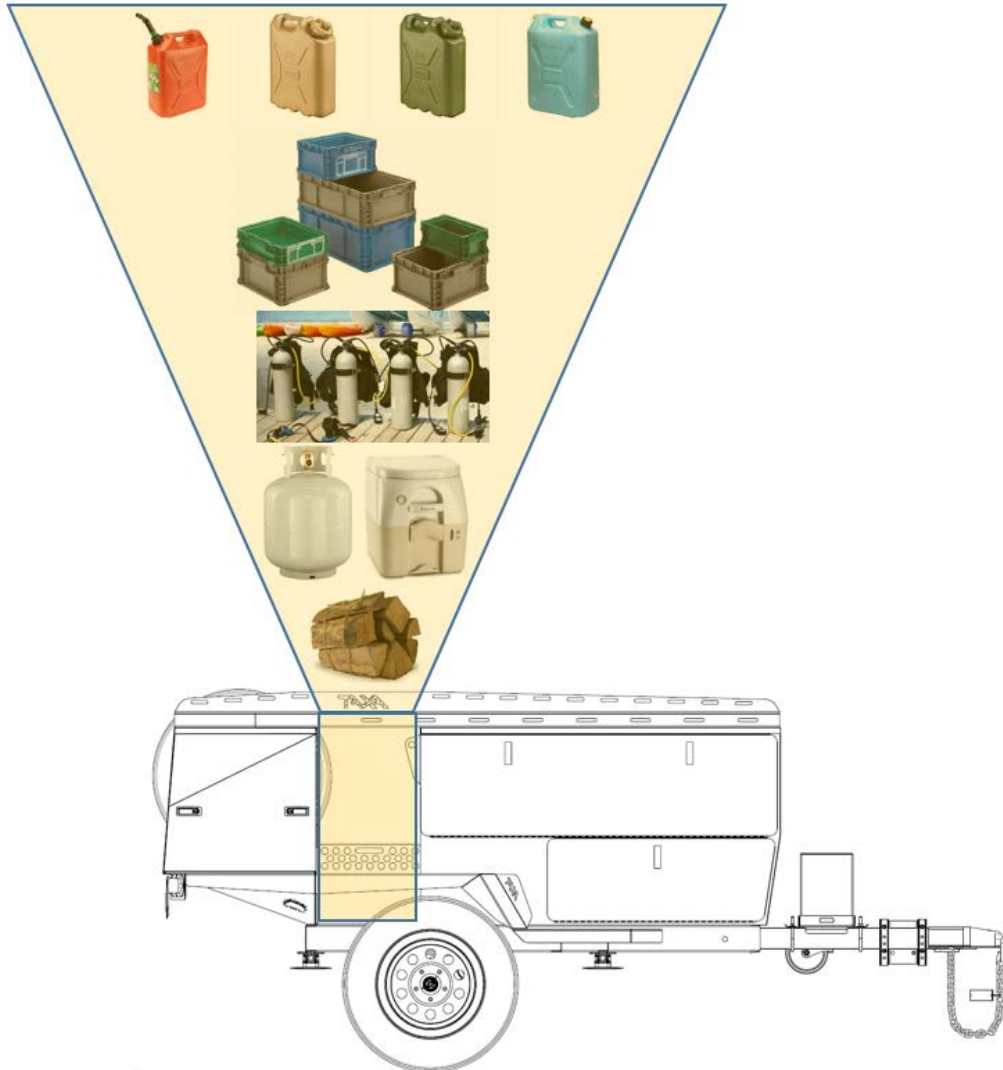

**ALWAYS LOAD YOUR TRAILER SAFELY - 10 TO 15% GVWR WEIGHT ON TONGUE**  
cargo bay storage suggestions



open air cargo bay – jerry cans, bucket, bungee net



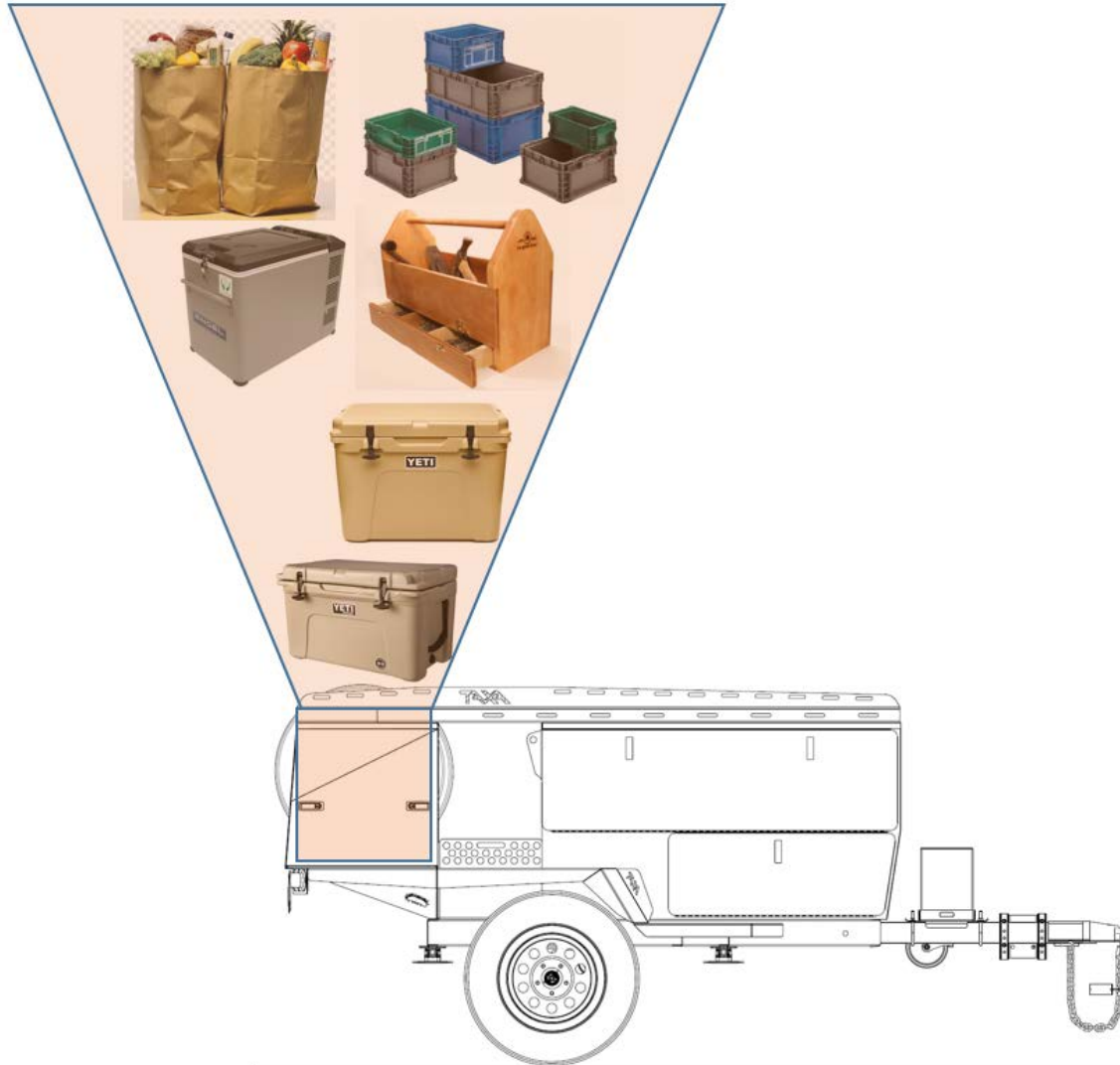

**ALWAYS LOAD YOUR TRAILER SAFELY - 10 TO 15% GVWR WEIGHT ON TONGUE**  
rear drawer cargo suggestions



cargo drawer – cooler (YETI 45 quart shown), tie down slots and cooler drain in drawer bottom



**ALWAYS LOAD YOUR TRAILER SAFELY - 10 TO 15% GVWR WEIGHT ON TONGUE**  
kitchen / workspace cargo suggestion



kitchen / workspace – night lighting, switches and USD outlets, cargo beneath

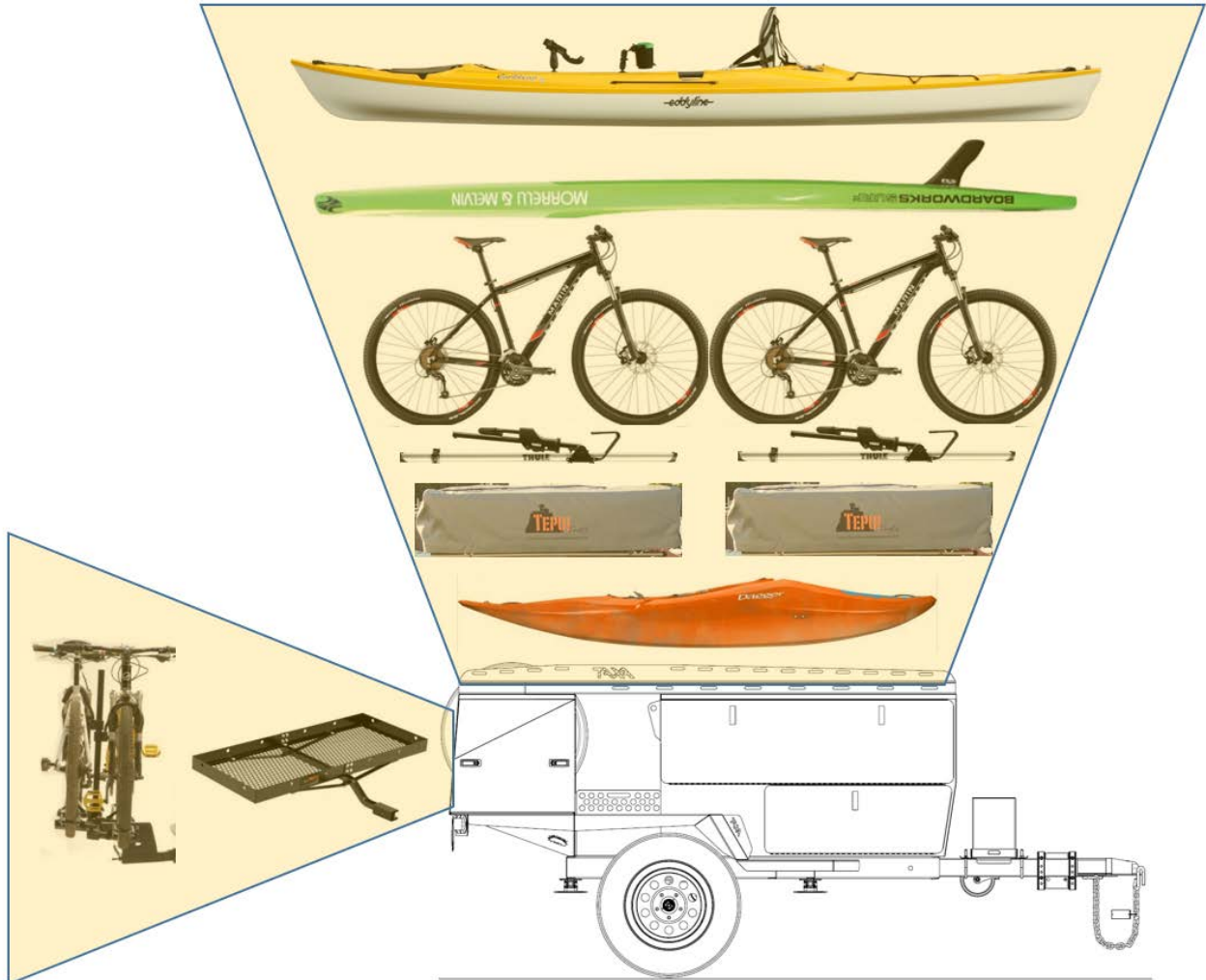

**ALWAYS LOAD YOUR TRAILER SAFELY - 10 TO 15% GVWR WEIGHT ON TONGUE**

cargo deck cargo suggestions



cargo deck – integrated tie down point, 5 locations for load bars allows multiple load arrays for usage or weight distribution



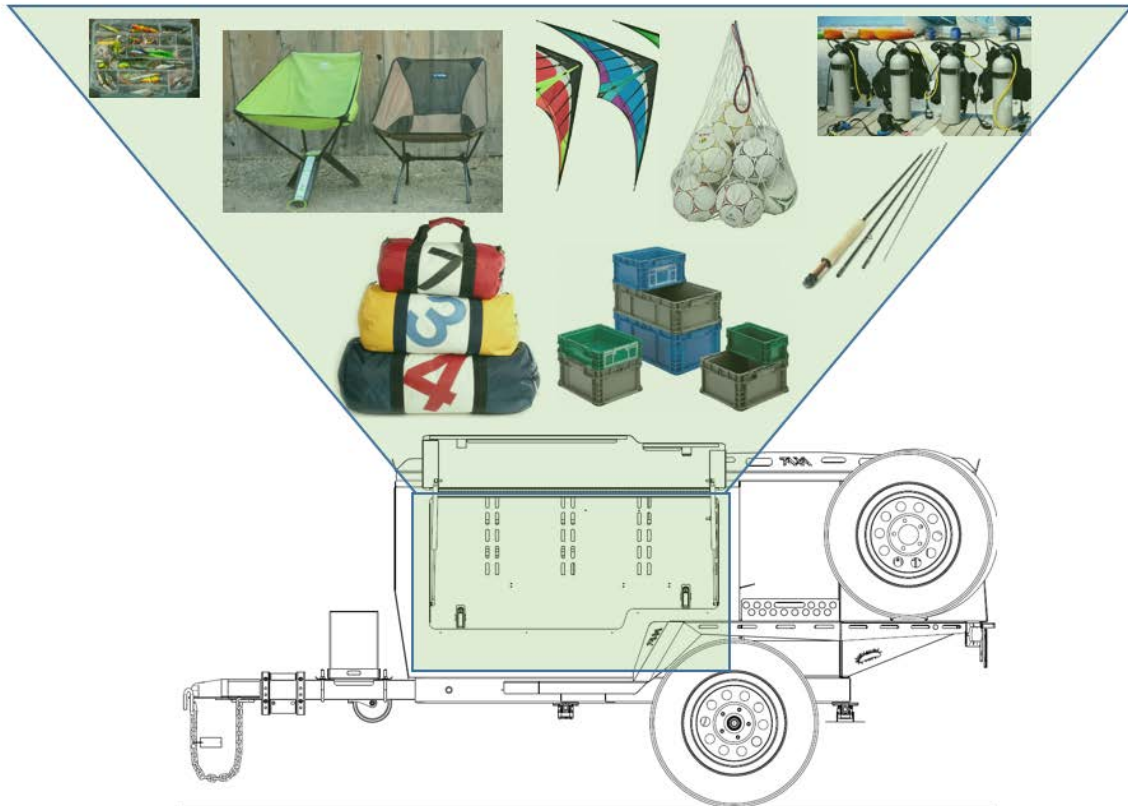

**ALWAYS LOAD YOUR TRAILER SAFELY - 10 TO 15% GVWR WEIGHT ON TONGUE**

cargo bay – attach points for tie downs, night lighting



cargo bay – night lighting, step bumper as useful shelf

## ELECTRICAL SYSTEM

Your WoollyBear's electrical system, if equipped, is a 12 Volt Direct Current (DC) system. This is explained as follows:

### 12V DC OVERVIEW

Your trailer 12 Volt system is powered by a 12V battery (see "Battery" section).

*7-pin connector* ... use your 7-pin connector plug to connect your tow vehicle and trailer electrical systems. This cord is located at the front of your trailer and plugs into a receptacle provided in your tow vehicle's hitch package. In addition to charging your trailer battery while driving, this connection powers your trailer lights. If your tow vehicle is not equipped with a 7 pin connection an adapter from 7 to 4 pins can be readily acquired. The trailer's driving lights will function. However, the trailer's battery will not be charged while driving. **BE SURE TO PLUG THE 7 PIN CONNECTOR WITH THE PROPER HOLES AT TOP AND BOTTOM. FAILURE TO DO SO MAY DAMAGE YOUR TRAILER WIRING AND ELECTRIC BRAKE SYSTEM.**

### 7 PIN WIRING C-11-1200-R0

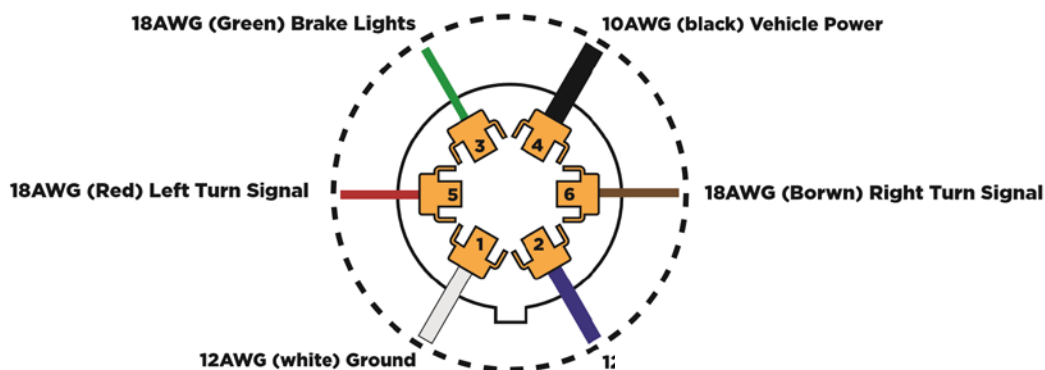

**We recommend disconnecting the 7 pin connector from the tow vehicle when camping**

When hitching and unhitching, be sure to move the 7-pin connector cord so it does not get damaged by, for example, the hitch and/or pin box. Do not allow the cord to drag on the ground and cover with a rag or soft cloth when not in use. Keep the connector clean and dry, and follow manufacturer instructions for cleaning if necessary. See also "Hitching" section for further discussion regarding your 7-pin connector.

*Important Note: you must refer to the manuals and other instructions of any and all aftermarket appliances, add-ons and/or accessories regarding their respective electrical requirements.*

**WARNING: NEVER REPLACE INSTALLED CIRCUIT BREAKERS OR FUSES WITH CIRCUIT BREAKERS OR FUSES OF HIGHER AMPERAGE RATING THAN THOSE ORIGINALLY INSTALLED. THIS COULD OVERHEAT THE WIRING AND START A FIRE.**





## BATTERY

overview ... a single DEEP CELL 12-volt battery may be supplied with your WoollyBear. It is specified and installed by your dealer. See below battery specifications and technical information as well as such information provided by the manufacturers of any additional and/or replacement batteries you purchase.

**WARNING: BATTERIES CONTAIN SULFURIC ACID, WHICH IS HIGHLY CORROSIVE, FLAMMABLE AND EXTREMELY DANGEROUS. THUS, WE STRONGLY RECOMMEND THAT YOU HAVE ALL BATTERY MAINTENANCE, SERVICING AND INSTALLATION PERFORMED BY A QUALIFIED TECHNICIAN.**

The battery is the heart of the 12-volt DC system. Thus, it is important that you keep the battery fully charged and monitor its charge state. Low battery charge and/or bad batteries are common causes of poor appliance and other component part performance. Fuses and circuit breakers can fail even without a short circuit under low voltage. Your battery is charged when driving while wired to a 7 pin connector, by a solar panel wired to the battery (we recommend using a charge controller!), or by a trickle charger.

Your trailer will generally be in one (1) of the following three (3) power states when in use: (1) *dry camping (not connected to shore power)* ... you will be using battery power only to operate lights and other DC components, and thus, discharging the batteries. Exercise constant vigilance in keeping your battery charged when dry camping. Make every reasonable effort to conserve your battery power (i.e. turn off lights and appliances when not being used);

(2) *being towed* ... if your tow vehicle has been wired properly, and is equipped with a 7 pin connector, your trailer's battery will charge while being towed (the rate of charge varies depending on the tow vehicle); and

(3) *connected to other 12v source* ... Connected to solar panels when off the grid, or to trickle charge when being stored. The rate of charge will vary based on the panels and solar exposure. PLEASE REFER TO SPECIFIC MAKES OF SOLAR PANELS ACCEPTED BY THIS SOLAR POWER INLET ON THE STICKER LOCATED NEAR THIS INLET. We recommend using a charge controller between panels and battery to prevent overcharging.

*installation* ... proper battery installation is critical. Thus, please see a qualified technician for the installation and/or replacement of your trailer batteries.

*inspection and monitoring* ... we recommend that you inspect and monitor the charge of the battery at least once a month and prior to any trip. During your inspection, look for cracks in the cover and case. Confirm that the hold-down hardware is tightly secured, that the battery box, tray or compartment is clean and free of corrosion, and that the vent caps and terminals are secure and tight. Note: Do not store anything in the trailer battery compartment, box or tray other than the battery and its various components.

*charging and storing* ... keep the battery fully charged but be sure not to overcharge the battery.

Here are three ways to charge your battery:

1. Attach 12V trickle charger to the poles of the battery inside the battery box.
2. Plug the trailer's 7-pin connector into an appropriately wired tow vehicle while the vehicle's engine is running.
3. Attach compatible solar panels to the poles of the battery inside the battery box

WHEN CAMPING, DETACH 7-PIN CONNECTOR FROM TOW VEHICLE. OTHERWISE IT IS POSSIBLE THAT THE TRAILER MAY DRAIN THE TOW VEHICLE'S BATTERY.

*dead batteries* .... If your battery is dead you may connect a 12V trickle charger to the battery and plug the other into a 120V receptacle, or the 7-way connector to your tow vehicle and run the engine at idle. If your tow vehicle battery is dead or discharged, an external jumper battery or battery charger must be used to either start your tow vehicle engine, or generator, if any.



## PRE-TRAVEL CHECKLIST

Turn off all switches at kitchen switch panel.

Be sure your cargo doors are secured.

Be sure 7-pin connector is secured.

Be sure the stabilizer jacks are fully raised and secured.

Check tire pressure and the tires generally for any punctures, cuts, and other problems.

Be sure wheel lug nuts are tight and secure.

Check that all tow vehicle and trailer lights and brakes are working in synchronization.

Be sure hitch assembly is secure, and that safety chains have been properly attached.

Check underneath trailer for any damage or displacement.

Important Note: This is not an exhaustive list nor is it intended to be. Use common sense when preparing for a trip and all other helpful resources available to you.



#### OTHER IMPORTANT PRE-TRAVEL CONSIDERATIONS

Be sure to pack wheel chocks and blocks.

Be sure cargo rack cargo and accessories, if any, are secure.

Be sure to monitor your battery's charge before and during your trip. Charge battery before travelling, if necessary.

Tow vehicle ... read and follow the manual and all pertinent instructions provided to you by your tow vehicle manufacturer. Be sure tow vehicle is operating fully before any trip, correcting any problems before travel.

Contact your dealer or Taxa Inc. if you have any questions before your trip.

Bring flashlight and batteries. Make sure your cell phones are charged and that you have phone chargers. Be sure computers, tablets and other electronic equipment are charged and have chargers.

Take spare battery and tire.

Check for any potential fire hazards, and eliminate them, if any.

Make sure there are no defects in sealants in and around your trailer.

Weigh your load before trip, making sure it does not exceed your GVWR.

## SITE SELECTION AND SET UP

With time and experience, you will get better at spotting and identifying good camping sites. Although they will vary to some degree, all good sites will (a) be level and (b) have a firm, not soft, ground that will support the weight of jacks and/or other support devices. There are also many public camping sites that provide electrical and other useful hook-ups or services. Once you have chosen your site, we suggest that you refer to the following important tips for your set-up:

*level and stable ....* (1) Before uncoupling, level the unit from side to side if desired with wood or plastic leveling blocks. Place the blocks on the ground forward of the wheels and tow the unit onto the blocks. Use wheel chocks to be sure the unit cannot roll;

(2) Lower the jack onto blocks or pad, if necessary;

(3) Once the unit is level, use wheel chocks or blocks to prevent the trailer from moving;

(4) Uncouple the trailer from the tow vehicle, unplug 7 pin connector from vehicle; and

(5) Lower the stabilizing jacks until they firmly engage. Be sure all jacks have about the same pressure on them.

Note: Before resuming travel, be sure that the stabilizer jacks are fully retracted/raised and that the trailer has been fully closed.

## OPERATION

**STEP 1.** Park RV on level ground, prevent wheels from rolling by using tire chocks.

**STEP 2.** Level trailer fore and aft using tongue jack or landing gear.

**STEP 3.** Check level gauge for low side of trailer, crank down stabilizers on low side first, bringing the trailer to a fine level position.

**STEP 4.** Crank down stabilizers on opposite side of

trailer to insure maximum stability. Then re-slug stabilizers on low side of trailer if necessary.

**NOTE - BEFORE MOVING TRAILER:** Crank up stabilizers to fully closed position and tighten 1/4 turn to secure in travel position (this prevents stabilizers from working open due to road vibration).

**MAINTENANCE:** Use small amounts of WD-40 or similar lubricant on drive screw threads and bolt locations as required.

**WARNING: DO NOT ATTEMPT TO USE JACKS STANDS OR STABILIZER JACKS TO JACK UP THE TRAILER OR SUPPORT THE FULL WEIGHT OF THE TRAILER. DO NOT ATTEMPT TO LEVEL, RAISE OR OTHERWISE PLACE ALL OF THE WEIGHT OF THE TRAILER ON THE STABILIZER JACKS. STABILIZER JACKS ARE NOT DESIGNED TO BEAR WEIGHT.**

*set-up cont. ...* once the unit is safely leveled and stabilized, continue with set-up:

(1)

(2) connect to shore power, if available;

(3) set up the remaining features and/or options as needed.



## FOUR SEASON USE / EXTREME WEATHER

Your trailer was NOT designed for use in extreme climates or weather situations. It was designed to be used any season you wish. Some conditions require special consideration or preparations.

**If conditions are extreme due to weather or other natural or unnatural causes BE SAFE!  
Get yourselves to safety. Get your vehicles to safety as a secondary concern.**

Your trailer was designed for short-term use (typically seven days or less) in normal, moderate temperature and climate conditions. Climates falling outside of this range are considered extreme for purposes of this manual and your trailer. Be advised that some of your trailer's systems and components are not appropriate for use in extreme climates (see further notes below). Please be advised that some damages, losses or injury arising out of use of your trailer in extreme climate conditions may not be covered under the Limited Warranty. See Limited Warranty section herein. **Thus, before you consider using your trailer in extreme conditions (which is NOT recommended and NOT covered under your Limited Warranty), please read the following:**

*battery and electrical systems ...* If you are dry camping (i.e. no shore power or generator), your battery will be your only source of power, and thus, your primary electrical system concern in extreme cold. Be sure to keep the battery charged and conserve available energy when possible. *Remember that there is no substitute for common sense when camping in extreme weather conditions.* Please also refer to the "Battery" and "Electrical System" sections herein.

### EXTREME HEAT and COLD

Please use common sense when camping. Extreme heat and extreme cold can cause injury and or death, especially to the elderly and young. Take all necessary precautions when camping.





## GENERAL CARE AND MAINTENANCE

Regular care & maintenance of your trailer is important in furthering safety and dependability. Keep good records of all service and maintenance performed on your WoollyBear. These records may be necessary for limited warranty purposes or may assist in future repairs..

*exterior finish* ... your trailer's exterior is made of painted galvanized steel panels. These are durable and easy to maintain. Routine maintenance is the best way to minimize and guard against cosmetic changes due to weathering. Wash the trailer exterior with a soft cloth, warm water and soap thoroughly, paying special attention to the graphics. Never use strong solvents or abrasives when cleaning. Be aware that power buffers and high pressure washers may damage or totally remove the graphics. See also the following summary of do's and don'ts:

Do use soft cloths to clean

Do be careful around graphics, washing with the graphics, not against them.

Do not use products containing ammonia or caustic, harsh cleaning agents.

Do not use high-pressure washers, rotating brushes (i.e. in-car wash facilities), or power buffers.

Do not dry wipe surfaces

Do not use rubbing compounds.

*frame and chassis* .... Over time, various weather and climate conditions may lead to corrosion your trailer frame and chassis. Be sure to rinse the trailer undercarriage, wheel wells, hitch and bumper of all dirt, oil, tar, salt and other debris periodically and as needed. Remember to routinely inspect for evidence of rust. Do so frequently when camping in or near coastal regions.

*hitch couplers* ... Inspect hitch couplers before each trip. Clean and lubricate the ball socket and clamp monthly using wheel bearing grease. If hitch assembly and coupler appears damaged in any way, contact your dealer and resolve the problem before travel.

*safety chains* ... Inspect safety chains before each trip. Replace them before travelling if they are damaged or compromised in any way.

*jacks* ... Inspect and test the jack before each trip. Clean and lightly apply oil periodically and as needed. If your jack needs repair or other service, see a qualified technician.

*tires and wheels* ... inspect your trailer tires, checking air pressure regularly and before each trip. Keep them inflated to recommended pressure, which is located on the tire sidewall. Keep a tire gauge in your tow vehicle or trailer. Have the tires rotated by a qualified technician at least every 5,000 miles.

*sealants* ... Inspect all sealants/seals (i.e. doors, undercarriage) every ninety (90) days, when the seasons change, and before each trip. During your inspection, look for cracks, voids, shrinkage, and any other sign of deterioration. Replace sealant where necessary, using the same type of sealant. Contact your dealer or Taxa Inc. for suggestions concerning replacement sealants.

*interior walls* ... clean with soap or other mild, non-abrasive cleaner, warm water, and a damp cloth. Do NOT use strong, harsh chemicals, and limit water/moisture exposure to top and walls when cleaning.



## STORAGE, WINTERIZATION & BRINGING OUT OF STORAGE

If storing your trailer in persistently cold weather (less than 20 degrees F), you must prepare your trailer appropriately. We recommend that you store your trailer in a dry, level, well-ventilated area protected from the elements. Use blocks, chocks or ramps for the wheels, if necessary. A garage is ideal. Refer to and follow the following storage preparation guidelines:

### *chassis ...*

Lubricate all grease fittings on the axle hubs

Check all tires for damage and set tire pressure to the maximum as indicated on the tire sidewall. Clean the tires and wheels with your regular soap/car wash solution

Clean the tires and wheels as well as the underside of the trailer. Wash off mud and/or other road accumulations on frame, axles, and other components. Inspect and make note of damage to or in any areas or components.

### *exterior ...*

Inspect the sealants around openings (compartments, racks, etc.),resealing as necessary before winter rains or snows accumulate (to prevent leaks when snow melts in spring).Be sure all exterior components, attachments, etc., cords, safety chains) are secured

Prevent trailer from rolling unexpectedly during storage - chock wheels, raise levelling jacks and retract step assembly.

*electrical system ...* preparation and winterization of the electrical system primarily revolves around your battery. Proper battery storage helps ensure both the powering up of your trailer systems on your next trip, and maximizing the life of your battery. Refer to the "Battery" section of this manual for proper storage information. Important Note: remember to turn off all electric loads in your trailer prior to storage. For long term storage disconnect leads to batteries.

## BRINGING OUT OF STORAGE

If your trailer was properly and carefully stored and winterized, taking it out of storage and prepping it for another travel season should be relatively simple. Note: if your trailer sustained damage while being stored, please consult with your dealer or Taxa Inc. for information regarding repair or service options. The following checklist assumes that you stored your trailer with care:

Thoroughly inspect the trailer exterior, looking for animal nests in, for example, wheel wells, compartments or openings.

- Open all doors and compartments, checking for animal or insect intrusion, water damage, or other deterioration
- Check charge level battery and recharge as needed.
- Check tire pressures and re-inflate to specified cold pressure
- Lube chassis
- Check all exterior lights, and replace as needed
- Check all 12-volt DC circuit fuses
- Operate all 12-volt DC lights and equipment
- Check your 7-pin connector, converter, all outlets and any exposed wiring. If defects are found, refer service to your dealer
- Inspect and clean the interior



## TROUBLESHOOTING

### Electrical

Description	Possible cause	Fix
Battery not charging (use 12v LED volt monitor in 12v outlet to monitor voltage : – a well charged battery is between 12.6 and 12.8V - + -.2V if solar or vehicle charging)	7-pin connector	Check tow hitch connection and wiring for shorts, corrosion, dirt, etc
	7-pin connector	Check trailer end connection
	battery box wiring	Check interior of battery box for loose or cracked wires
	Battery charge	Test battery
Circuit interruption	Overloaded circuit	replace fuses
Lights flickering or dim	Battery not charged	Check battery charge
Kitchen and passenger cargo lights out	blown fuse	Check fuse #1 (5 amp spade)
Driver's Side cargo lights out	blown fuse	Check fuse #2 (5 amp spade)
Ground light out	blown fuse	Check fuse #3 (5 amp spade)
Kitchen 12v outlet not functioning	blown fuse	Check fuse #4 (5 amp spade)

### Exterior

Description	Possible cause	Fix
Cargo / compartment door leak	gasket failure	check perimeter of gasket around compartment door, re-adhere or replace

## LIST OF AUTHORIZED DEALERS

Our dealers and their contact information are subject to change. Please refer to our website [www.taxaoutdoors.com](http://www.taxaoutdoors.com) for updated dealer and contact information lists.



## your LIMITED WARRANTY

We want you to enjoy your WoollyBear without problems. As the owner, you are responsible for regular care and proper maintenance of your WoollyBear. Proper use, care, and maintenance will help avoid situations under which the Limited Warranty will not cover items due to neglect or misuse. Maintenance should be performed in accordance with this manual as well as the corresponding component manufacturer's manuals included within your trailer. If you have any questions at all regarding proper care or maintenance, please contact your dealer or Taxa Inc.

This limited warranty gives you specific legal rights. You may also have additional legal rights, which vary from state to state. Taxa Inc.'s warranty obligations are limited to the terms set forth herein and applicable law. Any additional statements concerning this limited warranty not included herein, whether oral or written, are not the responsibility of Taxa Inc. and should not be relied upon by you. Please contact us if you have any questions regarding the following limited warranty.

### LIMITED WARRANTY COVERAGE

#### *Coverage - Electrical System*

Defects in material and workmanship in the electrical systems as originally installed by Taxa Inc. only. The duration of this Limited Warranty for the plumbing and electrical systems is for a period of one (1) year, beginning on the date of purchase by the original owner/purchaser and ending one (1) year from such date.

#### *Coverage – Structural*

Defects in material and workmanship in the structure of your trailer as originally installed by Taxa Inc. only. The duration of this Limited Warranty for the structure is for a period of two (2) years, beginning on the date of purchase by the original owner/purchaser and ending two (2) years from such date. The structure includes only the frame, steel boxes, step bumpers, cargo deck and their connection to each other. It does not include attachments to the structure. Attachments include but are not limited to the following: axles, stabilizer jacks, couplers, roof tracks, add-ons, accessories, component parts.

Taxa Inc. will, in its sole discretion, repair or replace, as necessary, the covered material or workmanship, at no cost to you and within industry standards. Taxa Inc. will also, in its sole discretion, use the same, substantially similar, new, remanufactured, refurbished, and/or reconditioned components, parts, materials and/or systems in fulfilling its obligations under this Limited Warranty. Taxa Inc., in its sole discretion, shall determine whether the dealer, service center, or other authorized facility is the appropriate location to perform the covered warranty repairs or replacement, if any. You shall be responsible for delivering the trailer to the dealer, service center or other facility designated by Taxa Inc. for such covered repairs or replacement, if any.

After a repair is performed, inspect it thoroughly. Go over the repairs with the dealer and/or service center representative. Upon your satisfaction, sign the repair order. In the event a problem should reoccur after you have left the dealer or other authorized facility, contact the dealer or Taxa Inc. as soon as possible so that the situation can be resolved quickly.

#### Owner's Responsibilities

Your responsibilities include: (1) carefully reviewing and following the information and instructions contained within this manual and all supplied component manuals; (2) proper care, use and maintenance of your trailer as outlined by this manual and all supplied component manuals; and (3) returning your trailer to an authorized dealer, service center or other facility authorized by Taxa Inc. to perform any necessary, covered warranty repairs, service or replacement.

#### WHO IS COVERED BY THIS LIMITED WARRANTY

Only the original purchaser/owner of the unit is covered under this Limited Warranty. This Limited Warranty is not transferable and does not cover subsequent purchasers/owners of the unit.

#### HOW TO PROPERLY SEEK A REMEDY UNDER THIS LIMITED WARRANTY

(1) Written or electronic notice of your warranty claim or claimed defects along with (2) your dated receipt as proof of purchase must be given either to the selling dealer or Taxa Inc. not later than ten (10) days after the expiration of the applicable limited warranty duration period as defined herein. Otherwise, your warranty claim will be considered untimely. Failure to timely notify of a warranty claim will void this limited warranty.

If your dealer is unable to resolve your warranty claim or you would like to first notify us of your warranty claim, please contact us as follows:



Taxa Inc., 1830 West 15<sup>th</sup> Street, Houston TX 77008, Tel: 713.861.2540, and Email: [hello@taxaoutdoors.com](mailto:hello@taxaoutdoors.com). Please also visit our website [www.taxaoutdoors.com](http://www.taxaoutdoors.com) for any updated contact information.

#### **SOLE AND EXCLUSIVE REMEDY**

**TO THE MAXIMUM EXTENT PERMITTED BY LAW, THIS LIMITED WARRANTY AND THE REMEDY EXPLAINED HEREIN ARE EXCLUSIVE AND IN LIEU OF ALL OTHER WARRANTIES, REMEDIES AND CONDITIONS, WHETHER ORAL OR WRITTEN, EXPRESS OR IMPLIED. TO THE MAXIMUM EXTENT PERMITTED BY LAW, TAXA INC. SPECIFICALLY DISCLAIMS ANY AND ALL IMPLIED WARRANTIES, INCLUDING WITHOUT LIMITATION, WARRANTIES OF MERCHANTABILITY AND FITNESS FOR A PARTICULAR PURPOSE. THE FOREGOING DISCLAIMER OF IMPLIED WARRANTIES SHALL NOT APPLY TO YOU OR THE TRAILER IF SUCH DISCLAIMER IS IMPERMISSIBLE UNDER APPLICABLE LAW.**

#### **WHAT IS NOT COVERED UNDER THIS LIMITED WARRANTY/EXCLUSIONS**

This limited warranty does not cover any damage, loss, deterioration or malfunction resulting from any alteration, modification, improper or unreasonable use or maintenance, misuse, abuse, tampering, accident, neglect, exposure to excess moisture, fire, lightning, power surges, and/or acts of nature or God. This limited warranty does not cover any damage, loss, deterioration or malfunction resulting from any repairs attempted by anyone unauthorized by Taxa Inc. to make such repairs, or any other cause which does not relate directly to a defect in materials and/or the workmanship of this unit.

Without limiting any other exclusion herein, Taxa Inc. shall not be liable for any incidental or consequential damages, including but not limited to travel, transportation, and lodging expenses, loss or damage to personal property, loss of use, inconvenience or loss of income whenever allowable under state law. Damages for any failure to successfully repair or replace any defect in accordance with this limited warranty shall be limited to the reasonable cost of such repair or replacement as of the time of the alleged failure or defect. This exclusion of consequential and incidental damages shall be deemed independent of, and shall survive, any failure of the essential purpose of this limited warranty.

THE FOLLOWING NUMBERED LIST (1 THROUGH 24) IS NOT EXHAUSTIVE AND DOES NOT LIMIT ANY OTHER EXCLUSION OR LIMITATION DISCUSSED HEREIN OR PERMITTED BY APPLICABLE LAW. THIS LIMITED WARRANTY SHALL NOT COVER NOR APPLY TO:

- (1) Items not manufactured, installed or sold by Taxa Inc., whether warranted separately or not by their respective manufacturers, including but not limited to, tires, batteries, fuses, ac units, heaters, refrigerators, porta-potti's, roof racks, generators, structural and other modifications, and all other such equipment, products, accessories, components, parts, add-ons, appliances, and attachments;
- (2) Trailers used for and/or damage or loss arising from business, rental, commercial, residential, or disaster relief purposes/uses, and/or any non-recreational purpose/use;
- (3) Trailers not originally sold through an authorized Taxa Inc. dealer;
- (4) Trailers sold through auction, repossession, salvage or in an otherwise "distressed" condition, etc.;
- (5) Damage or loss caused in whole or in part by the acts or omissions of any kind by any party other than Taxa Inc., its agents, representatives or employees;
- (6) Damage or loss caused in whole or in part by misuse, abuse, neglect, theft, vandalism, product modification, improper owner, customer or dealer installation, incorrect line voltage, unauthorized repair or failure to properly maintain and/or to follow instructions in accordance with this manual. In particular but not limited to, damages from failure to regularly check, inspect and maintain sealants and seals around roof penetrations, attachments, windows, doors, joints, and seams shall not be covered under this limited warranty;
- (7) Routine/normal maintenance and service items including without limitation, caulking, re-caulking and waxing of the body of the trailer, tightening screws, brakes, latches, locks, changing fuses, or light bulbs, maintaining the batteries, air conditioning, heating, plumbing and electrical systems, lubricants, sealant and seals, etc., and/or damages resulting from lack of proper maintenance and servicing;
- (8) Adjustments to all doors, drawers, locks, latches, slide-outs, awnings and window treatments after ninety (90) days of the date of the original retail sale;
- (9) Damage or loss caused in whole or in part by unauthorized attachments, modifications or alterations to the structure, body,



- pin box, or frame of the unit including but not limited to trailer hitches, or platforms for supporting cargo;
- (10) Normal deterioration due to wear or exposure such as but not limited to upholstery damage, fading of fabrics, drapes, carpet wear, tears, punctures, dents and/or scratches to the exterior from the roadway, hanging branches, etc.;
- (11) Damage or loss caused in whole or in part by the overloading or the improper balancing/distribution of the load;
- (12) Damage or loss caused in whole or in part by the willful or negligent acts of the driver of the tow vehicle, an accident involving the trailer, the condition of any road surface over which the trailer is pulled, or the striking or driving over or through a curb or any other object;
- (13) Damage or loss to the trailer caused in whole or in part by the tow vehicle including but not limited to the improper selection or installation of towing hitch and hitch assembly on the tow vehicle;
- (14) Any injury, loss or damage due to mold, bacteria or fungi;
- (15) Damage or loss caused by or arising from the operation, use, or misuse of the tow vehicle;
- (16) Any and all damage or loss to the tow vehicle;
- (17) Damage to electronics due to voltage issues;
- (18) Representations made by any person (including your dealer) beyond those stated in this Limited Warranty;
- (19) Any incidental and consequential damages or loss, and extra expenses including, but not limited to, transportation generally, transportation to and from dealer or authorized service center or manufacturing location, loss of time, loss of pay, loss of use of the trailer, inconvenience, commercial loss, towing charges, bus and taxi fares, vehicle rental, telephone calls, fuel, food, lodging, etc.;
- (20) Damage caused by or related to: (a) Accidents, misuse, recklessness, indifference, or negligence; (b) Failure to comply with instructions contained in this Owner's Manual or any other manual related to your unit; (c) Alteration, change or modification of the trailer or damage incurred resulting from alteration, change or modification; and (d) exposure to natural atmospheric elements or environmental conditions, chemicals, ash or fumes generated or released by vehicles or any other item, collision, road hazards, rock chips, condensation, or any other source (salt, hail, Acts of God, etc.);
- (21) Damages related to moisture, condensation, mold, saturation or water;
- (22) damages to your cargo or tow loads;
- (23) damages resulting from or related to the use of your trailer in extreme weather conditions as defined in the "severe weather use" section of this manual.
- (24) any item not specifically listed in the coverage paragraphs of this section.

#### APPLIANCES/COMPONENT PARTS/ACCESSORIES

Be advised that the manufacturers of some, if not all, of your trailer's appliances, component parts, add-ons and accessories will offer you their own separate warranties. Such wholly separate, additional warranties, if any, are administered directly from and are the sole responsibility of the manufacturer of the specific component part or appliance. Taxa Inc. has no responsibility nor does it have any obligation related to these wholly separate, additional warranties, if any.

You are solely responsible for timely completing and forwarding warranty forms and registrations, and the proper processing of all warranty claims for all components, add-ons, and appliances installed in your trailer. Failure to do so may result in loss of warranty coverage by the component or appliance manufacturer. Note: upon your request, Taxa Inc. may, in its sole discretion, reasonably assist you in the processing of such separate warranty.

#### LEGAL CONSIDERATIONS

*Choice of Law* . . . to the maximum extent permitted by Law, the laws of the State of Texas shall apply to the terms of this Manual and Limited Warranty, and any and all disputes arising out of any limited warranty claim or the purchase or repair of your trailer.

*Venue* . . . to the maximum extent permitted by law, Houston, Harris County, Texas shall be the proper venue for any suit filed by you arising out of any limited warranty claim or the purchase or repair of your trailer.

*Mediation* . . . to the maximum extent permitted by law, a mediation by and through an agreed upon mediator shall be conducted prior to the filing of any suit by you arising out of any limited warranty claim or the purchase or repair of your trailer.