

HUAYI
Lighting+Solutions



**ALIEN
CATALOGUE
2024**

HUAYI
Lighting+Solutions

www.huayilighting.com



NEW



- Positioning groove 355 ° horizontal rotation+Stepless regulation0~30°at any angle,Convenient adjustment.
- Family design - full range of spotlights, different needs and different choices, face rings can choose a variety of styles.
- Provide five kinds of Optical form:Original Type / BlackHole Type / Snout Type / Acrylic Type / Reflector Cup Type.
- Suitable for high-end hotels, villas clubs, high-end residential, for your business life to provide a more comfortable and healthy lighting space.
- Reflector cover 6 colors are optional to meet the needs of different occasions.

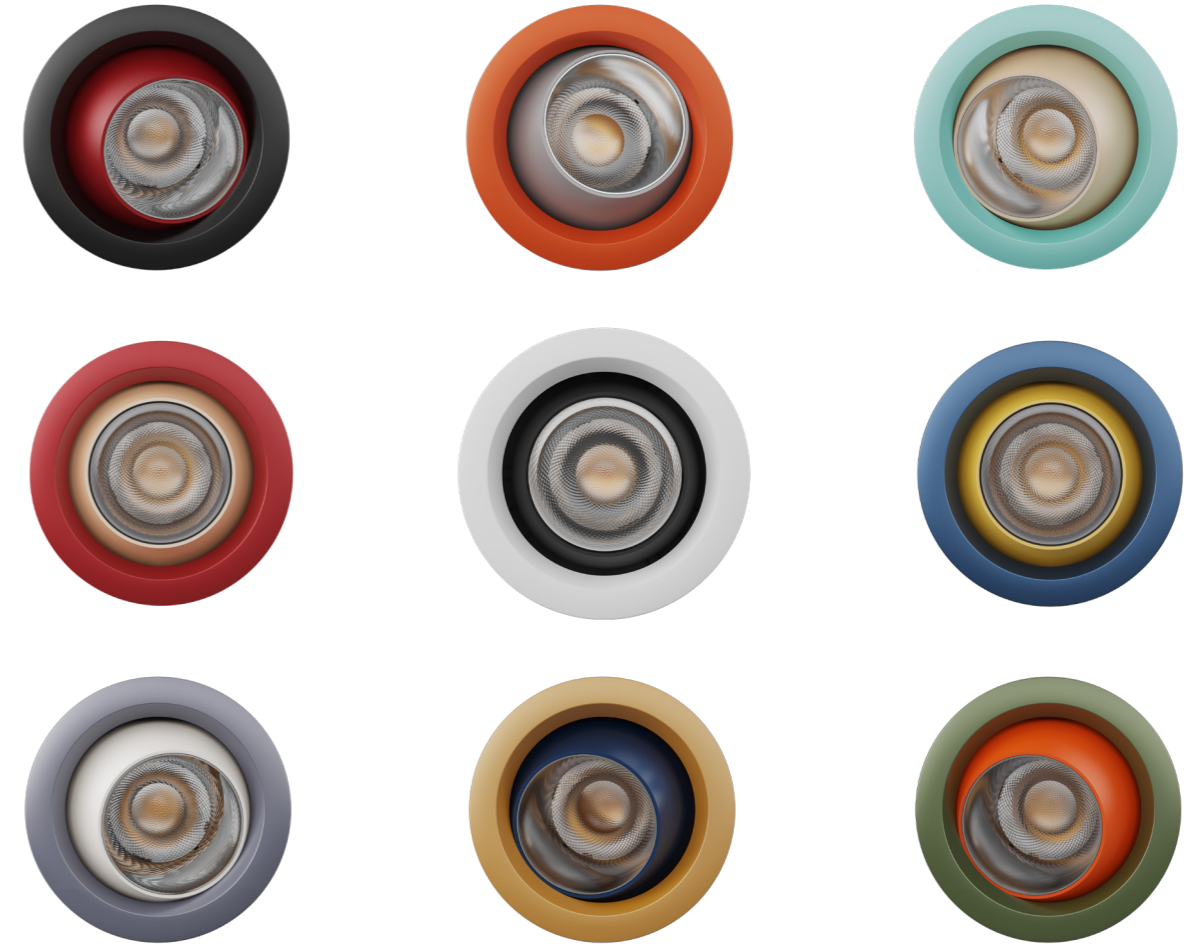

Cool and fashionable bright colors Matching urban aesthetics

Mix and match the fashion atmosphere to attack the front line of style. Their color confrontation and collision can express the meaning that is difficult to express

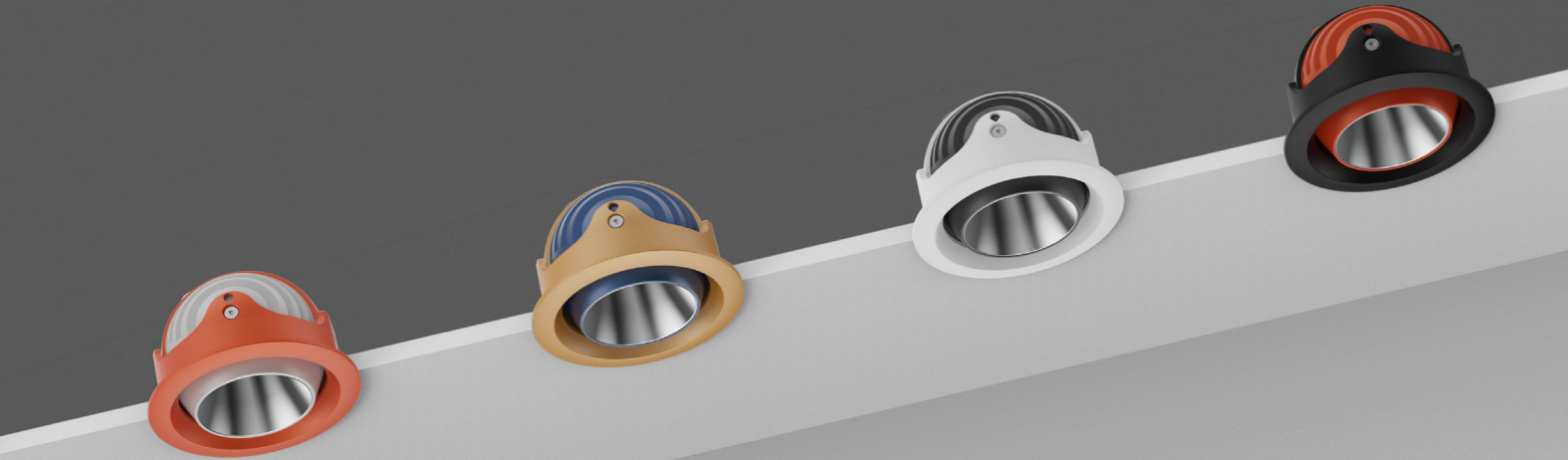

Seeing is believing

Visually diverse, new ideas thinking every second
 Abandon the definition and transcend the functional boundary of accessories
 Derive decoration imagination and overlay bright layers

Ceiling can also be a visual art



Family design

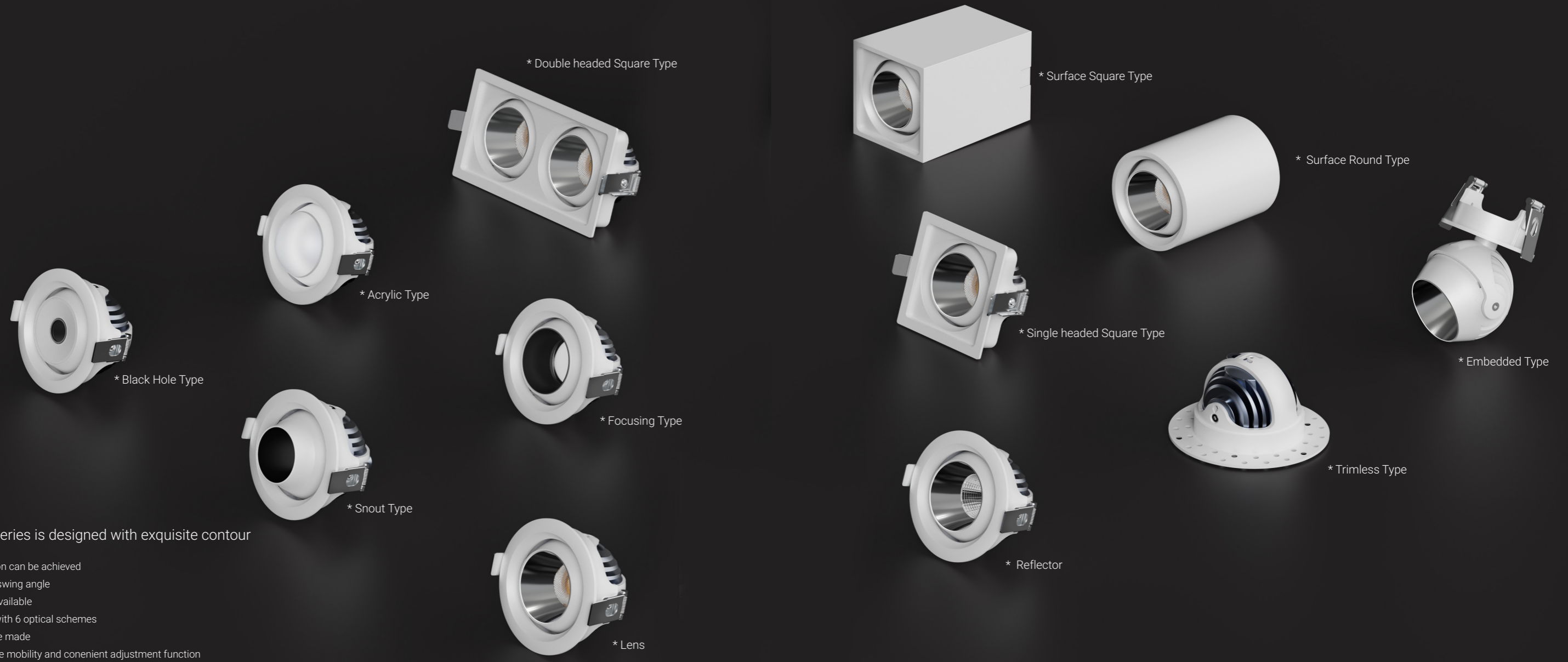

ALIEN series is designed with exquisite contour

- 355 rotation can be achieved
- 30 degree swing angle
- 11 forms available
- Equipped with 6 optical schemes
- IP54 can be made
- With flexible mobility and convenient adjustment function
- Meet the needs of multiple scenarios



ALIEN series is designed with exquisite contour

- ① 355 ° rotation can be achieved
- ② 30 degree swing angle
- ③ 11 forms available
- ④ Equipped with 6 optical schemes
- ⑤ IP54 can be made
- ⑥ With flexible mobility and convenient adjustment function
- ⑦ Meet the needs of multiple scenarios

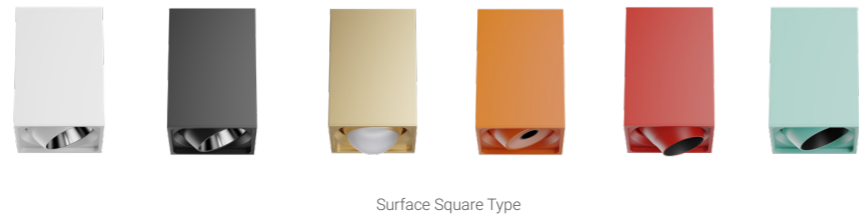

Product structure

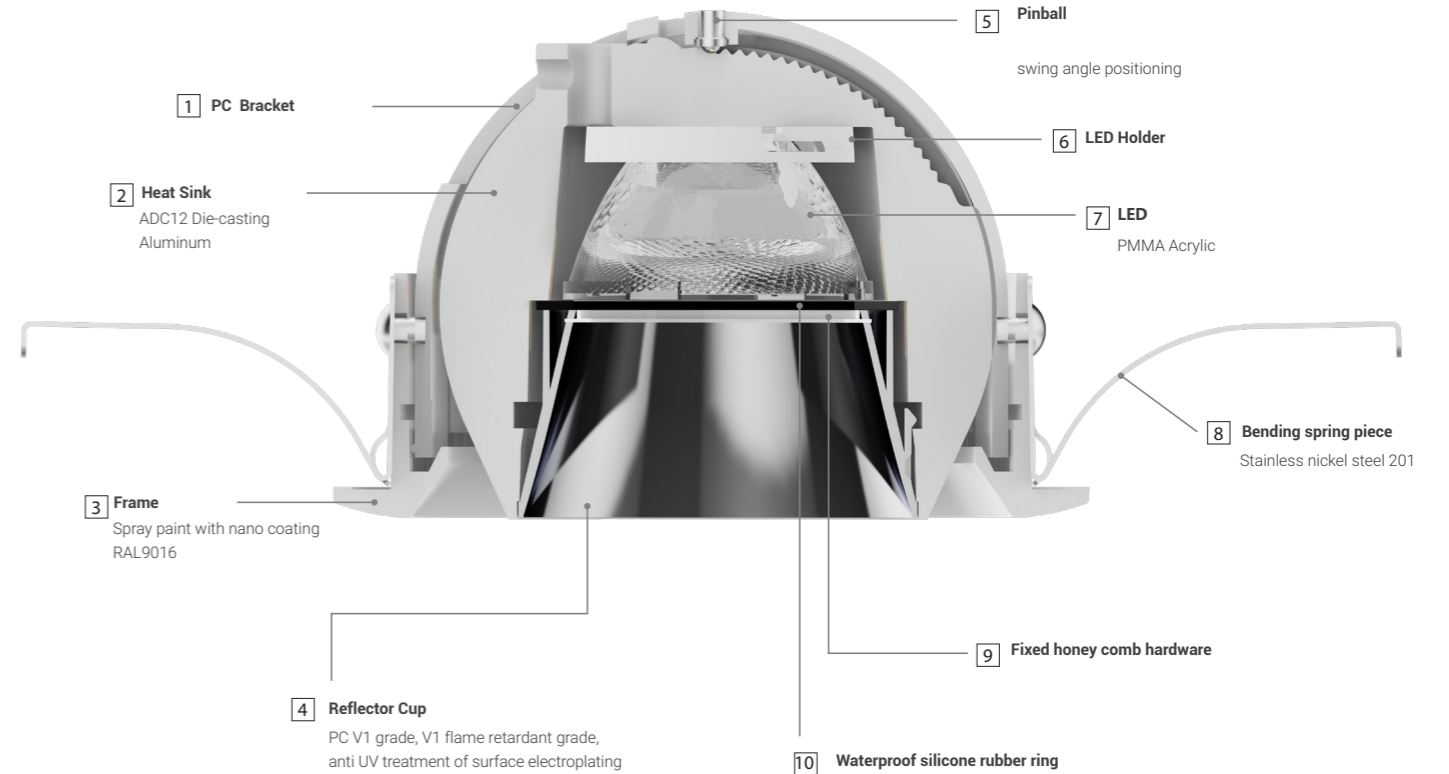

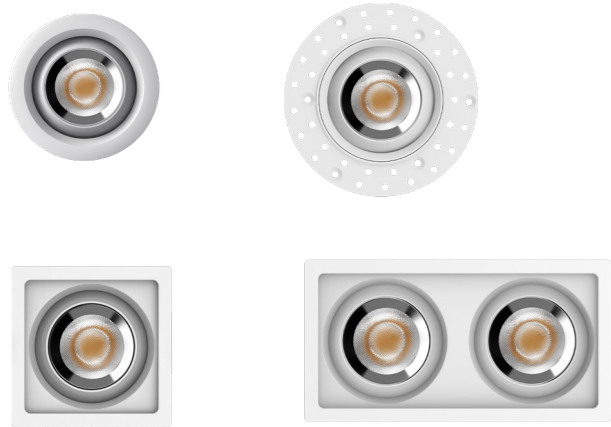

4 kinds of frame can be selected

Four kinds of frame can be selected: round, integral trimless, square single head, square double head



5 hole sizes available

Hole size: Φ 55,65,75,95,120, Suitable for different power wattage

Optical lens and reflector can be switched

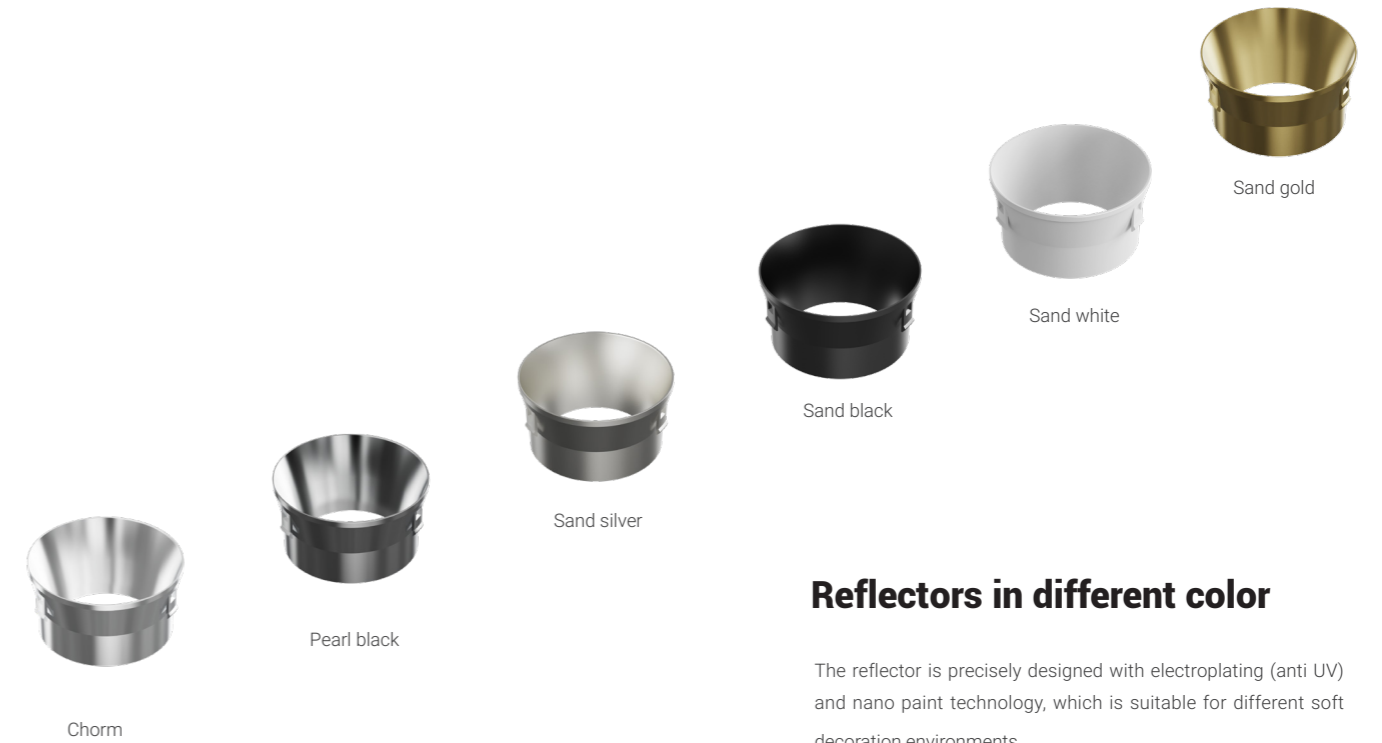
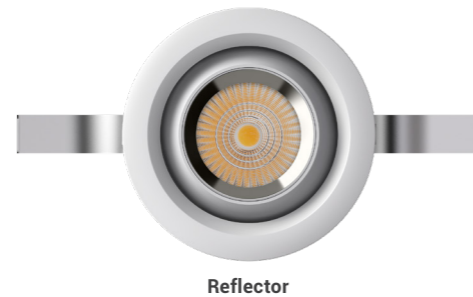
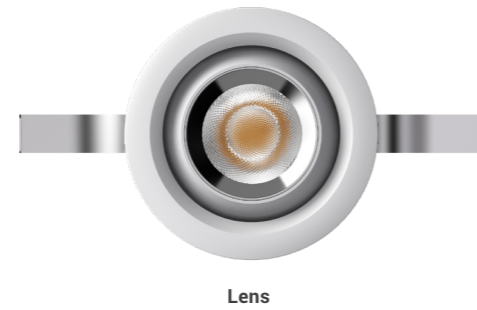

Reflectors in different color

The reflector is precisely designed with electroplating (anti UV) and nano paint technology, which is suitable for different soft decoration environments

Definition of pinball Achievement focus



Metal pinball, when swinging angle, the pinball moves up and down with the gear rolling. When popping up to the serrated concave point, fasten the radiator to prevent looseness.

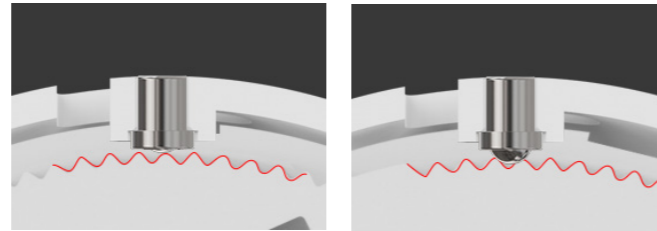

Extremely narrow edge design



/Frame height: 1.5mm

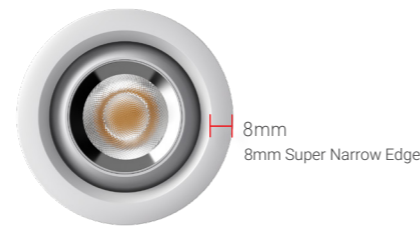

8mm
8mm Super Narrow Edge



Convenient adjustment Can be rotated to all angles

Pragmatism, ingenious details

0~30°

Stepless regulation 0~30°at any angle

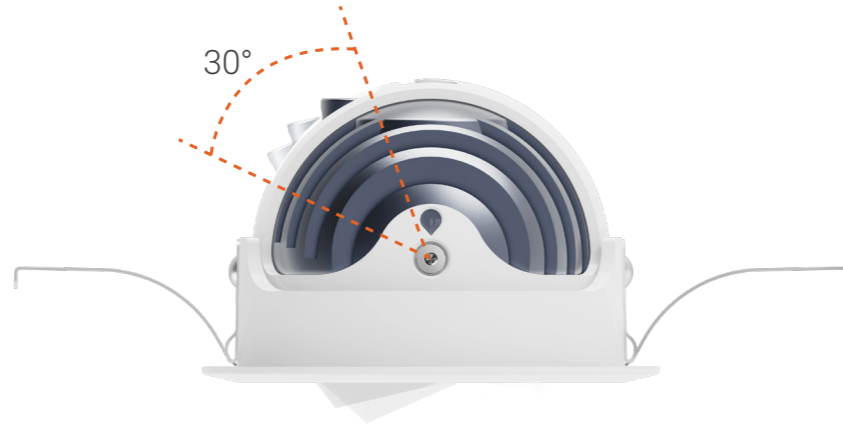

355°

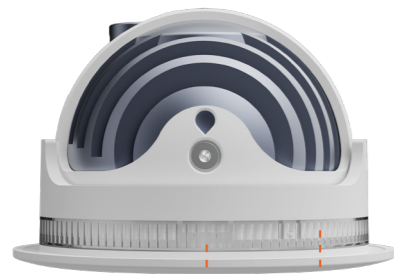

Damping

Positioning gear

Positioning groove 355 °horizontal rotation

Horizontal rotation of 355 °,
with positioning
point and damping to Fool-proof

Six optical forms,all brilliant

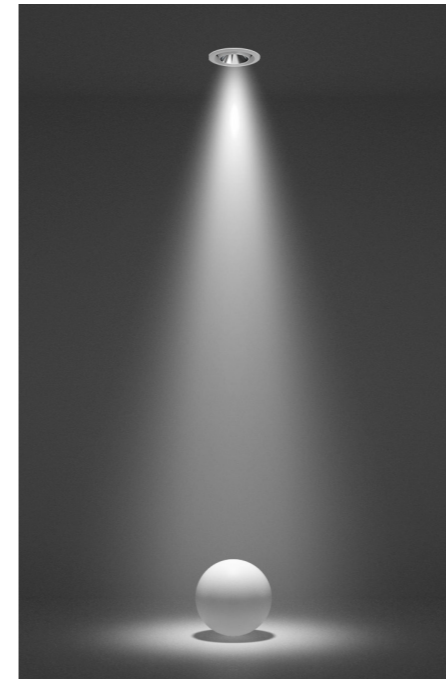

Original Type



UGR<13

Beam angle:10°/15°/24°/36°/50°

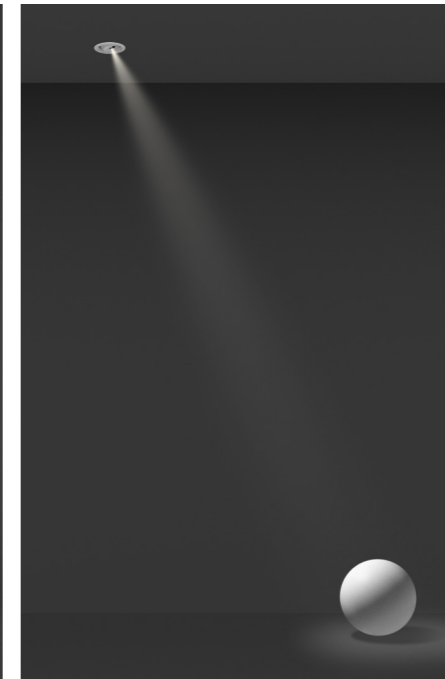

BlackHole Type



UGR<9

Beam angle:24°/36°

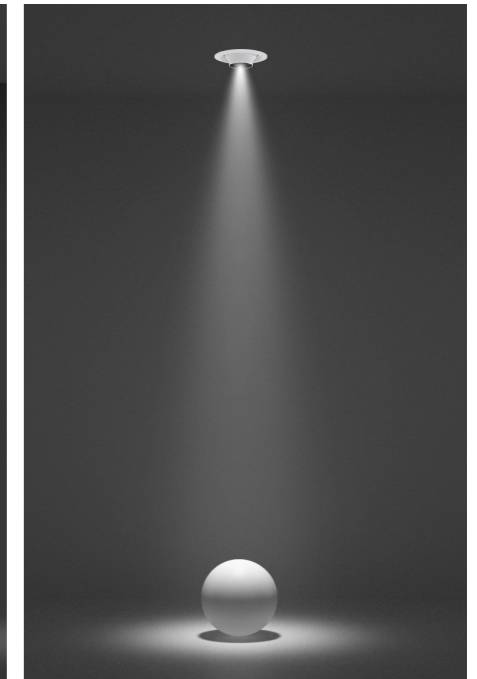

Snout Type



UGR<9

Beam angle:10°/15°/ 24° /36° /50°

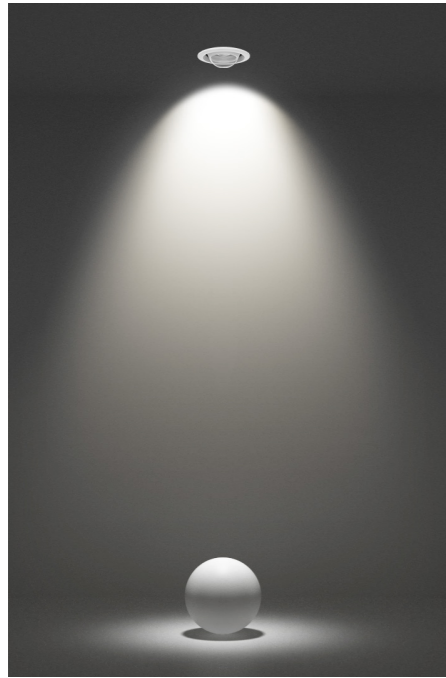

Acrylic Type



Basic flood lighting
Beam angle:120°

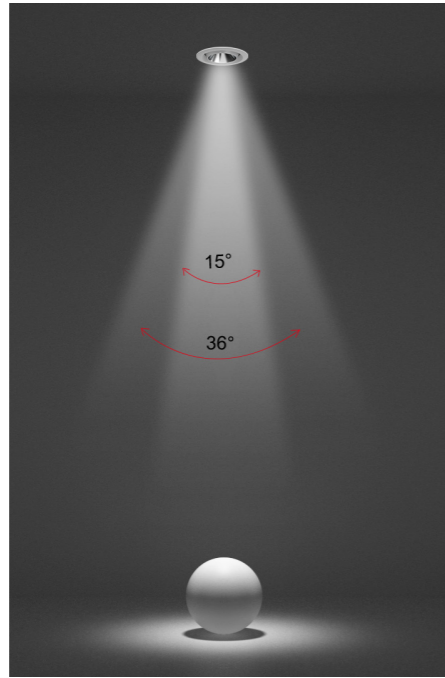

Focusing Type



UGR<9
Beam angle:15°~36°

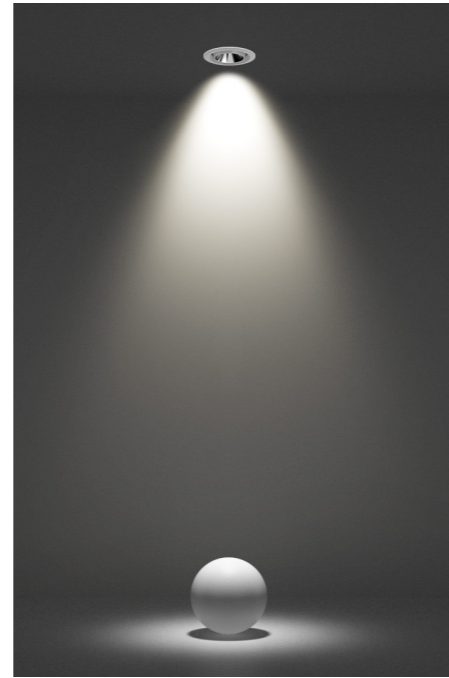

Reflector Type



UGR<13
Beam angle:18°/24°/38°

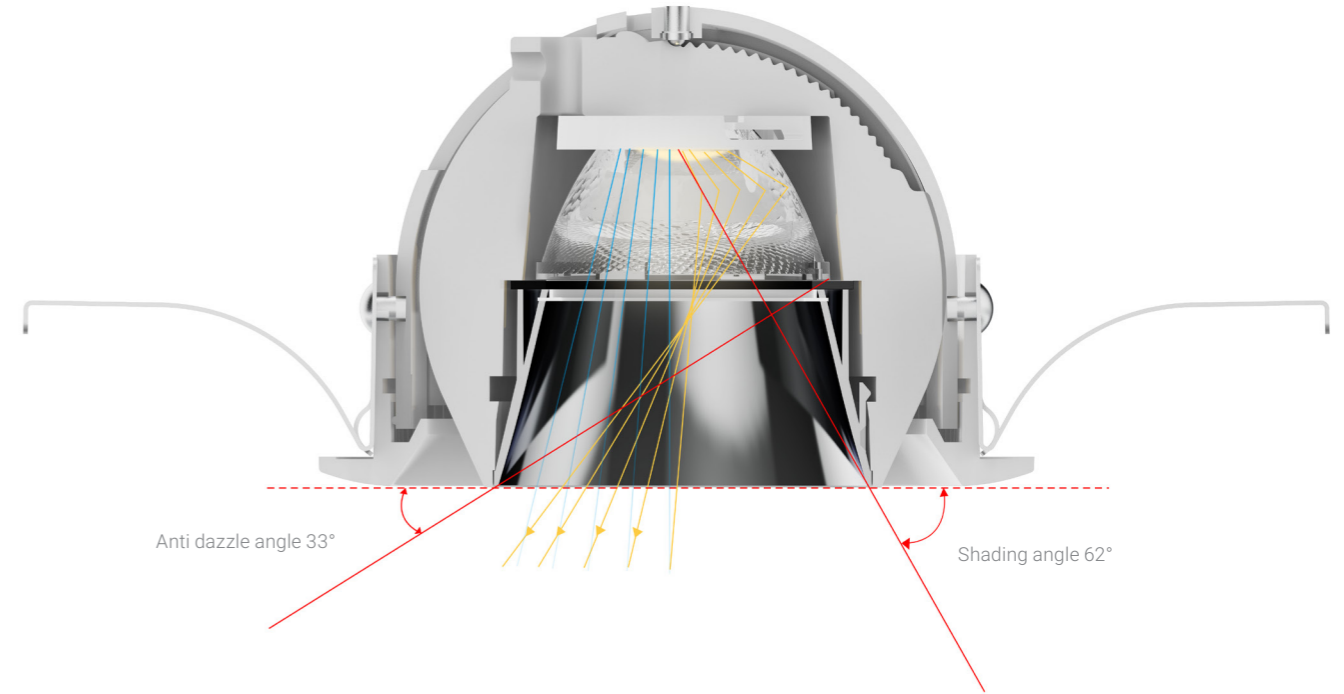



PMMA high luminous rate Ribbed structure lens

Adopting a ribbed structure design, with built-in anti glare effect, transparent luster, strong penetration, high effective illumination rate, precise visual beam angle, and high light source color gamut restoration.

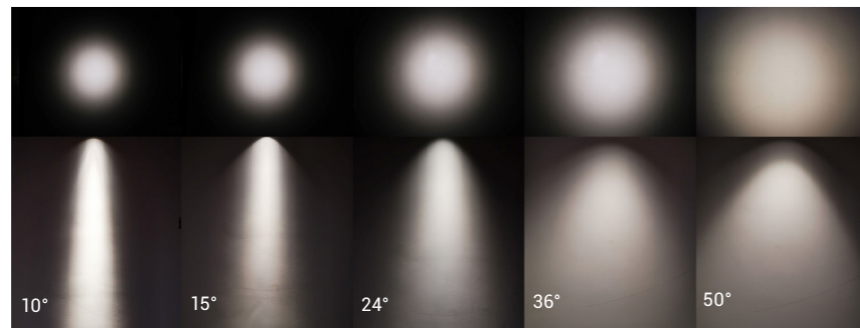

Colour:  Gold  Chorm  Black  White  Silver  Pearl black

Optional :  Honey comb

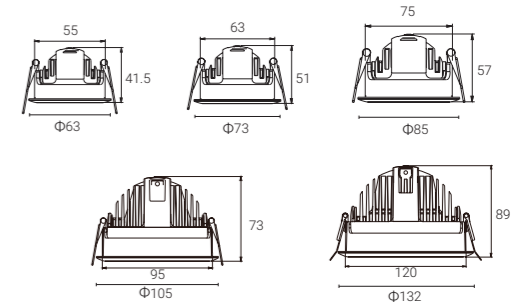

XQ-1001E55-PK-LENS / XQ-1001E65-PK-LENS / XQ-1001E75-PK-LENS / XQ-1001E95-PK-LENS / XQ-1001E120-PK-LENS

Model Code	XQ-1001E55-PK-LENS	XQ-1001E65-PK-LENS	XQ-1001E75-PK-LENS	XQ-1001E95-PK-LENS	XQ-1001E120-PK-LENS
Power	6W	8W	12W	18W	30W
Cut out	Φ55mm	Φ65mm	Φ75mm	Φ95mm	Φ120mm
Light Source	CREE	CREE	CREE	CREE	CREE
Size(DxH)	Ø63x41.5mm	Ø73x51mm	Ø85x57mm	Ø105x73mm	Ø132x89mm
UGR	<13	<13	<13	<13	<13
CRI	≥80/≥90	≥80/≥90	≥80/≥90	≥80/≥90	≥80/≥90
Beam angle	10°/15°/ 24°/ 36°/ 50°	10°/15°/ 24°/ 36°/ 50°	10°/15°/ 24°/ 36°/ 50°	10°/15°/ 24°/ 36°/ 50°	10°/15°/ 24°/ 36°/ 50°
CCT	2700K/3000K/4000K/5000K	2700K/3000K/4000K/5000K	2700K/3000K/4000K/5000K	2700K/3000K/4000K/5000K	2700K/3000K/4000K/5000K
Life time	50000 h	50000 h	50000 h	50000 h	50000 h
IP	IP20/IP44	IP20/IP44	IP20/IP44	IP20/IP44	IP20/IP44



• Embedded - Reflector

Colour:



Optional :

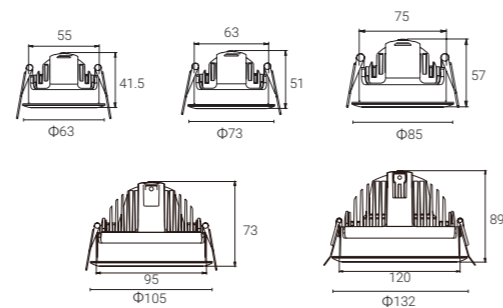

XQ-1001E55-PK-FGB / XQ-1001E65-PK-FGB / XQ-1001E75-PK-FGB / XQ-1001E95-PK-FGB / XQ-1001E120-PK-FGB

Model Code	XQ-1001E55-PK-FGB	XQ-1001E65-PK-FGB	XQ-1001E75-PK-FGB	XQ-1001E95-PK-FGB	XQ-1001E120-PK-FGB
Power	6W	8W	12W	18W	30W
Cut out	Φ55mm	Φ65mm	Φ75mm	Φ95mm	Φ120mm
Light Source	CREE	CREE	CREE	CREE	CREE
Size(DxH)	Ø63x41.5mm	Ø73x51mm	Ø85x57mm	Ø105x73mm	Ø132x89mm

UGR	<13	<13	<13	<13	<13
CRI	≥80/≥90	≥80/≥90	≥80/≥90	≥80/≥90	≥80/≥90
Beam angle	18°/ 24°/ 38°	18°/ 24°/ 38°	18°/ 24°/ 38°	18°/ 24°/ 38°	18°/ 24°/ 38°

CCT	2700K/3000K/4000K/5000K	2700K/3000K/4000K/5000K	2700K/3000K/4000K/5000K	2700K/3000K/4000K/5000K	2700K/3000K/4000K/5000K
Life time	50000 h	50000 h	50000 h	50000 h	50000 h
IP	IP20/IP44	IP20/IP44	IP20/IP44	IP20/IP44	IP20/IP44



• Embedded - Acrylic Type

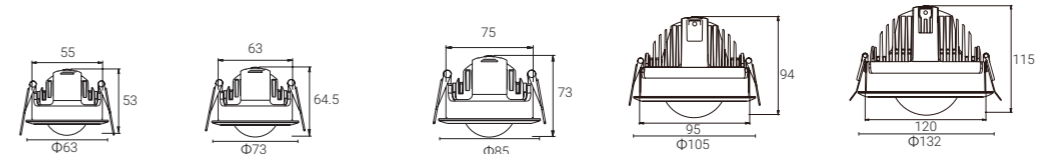

XQ-1001E55-FG-FGB / XQ-1001E65-FG-FGB / XQ-1001E75-FG-FGB / XQ-1001E95-FG-FGB / XQ-1001E120-FG-FGB

Model Code	XQ-1001E55-FG-FGB	XQ-1001E65-FG-FGB	XQ-1001E75-FG-FGB	XQ-1001E95-FG-FGB	XQ-1001E120-FG-FGB
Power	6W	8W	12W	18W	30W
Cut out	Φ55mm	Φ65mm	Φ75mm	Φ95mm	Φ120mm
Light Source	CREE	CREE	CREE	CREE	CREE
Size(DxH)	Ø63x53mm	Ø73x64.5mm	Ø85x73mm	Ø105x94mm	Ø132x115mm

UGR	-	-	-	-	-
CRI	≥80/≥90	≥80/≥90	≥80/≥90	≥80/≥90	≥80/≥90
Beam angle	120°	120°	120°	120°	120°

CCT	2700K/3000K/4000K/5000K	2700K/3000K/4000K/5000K	2700K/3000K/4000K/5000K	2700K/3000K/4000K/5000K	2700K/3000K/4000K/5000K
Life time	50000 h	50000 h	50000 h	50000 h	50000 h
IP	IP20	IP20	IP20	IP20	IP20



• Embedded - Black Hole Type

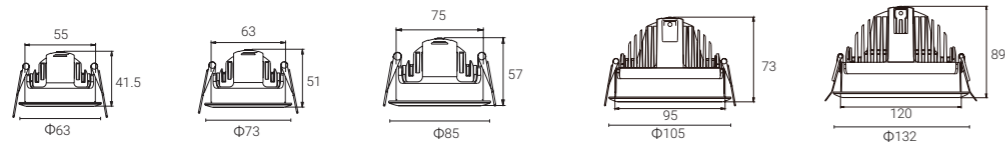

XQ-1001E55-HD / XQ-1001E65-HD / XQ-1001E75-HD / XQ-1001E95-HD / XQ-1001E120-HD

Model Code	XQ-1001E55-HD	XQ-1001E65-HD	XQ-1001E75-HD	XQ-1001E95-HD	XQ-1001E120-HD
Power	5W	7W	9W	15W	25W
Cut out	Φ55mm	Φ65mm	Φ75mm	Φ95mm	Φ120mm
Light Source	CREE	CREE	CREE	CREE	CREE
Size(DxH)	Ø63x41.5mm	Ø73x51mm	Ø85x57mm	Ø105x73mm	Ø132x89mm

UGR	<9	<9	<9	<9	<9
CRI	≥80/≥90	≥80/≥90	≥80/≥90	≥80/≥90	≥80/≥90
Beam angle	24°/36°	24°/36°	24°/36°	24°/36°	24°/36°

CCT	2700K/3000K/4000K/5000K	2700K/3000K/4000K/5000K	2700K/3000K/4000K/5000K	2700K/3000K/4000K/5000K	2700K/3000K/4000K/5000K
Life time	50000 h	50000 h	50000 h	50000 h	50000 h
IP	IP20	IP20	IP20	IP20	IP20



• Embedded - Snout Type

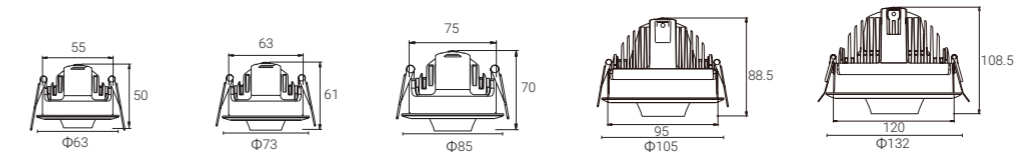

XQ-1001E55-ZY-LENS / XQ-1001E65-ZY-LENS / XQ-1001E75-ZY-LENS / XQ-1001E95-ZY-LENS / XQ-1001E120-ZY-LENS

Model Code	XQ-1001E55-ZY-LENS	XQ-1001E65-ZY-LENS	XQ-1001E75-ZY-LENS	XQ-1001E95-ZY-LENS	XQ-1001E120-ZY-LENS
Power	6W	8W	12W	18W	30W
Cut out	Φ55mm	Φ65mm	Φ75mm	Φ95mm	Φ120mm
Light Source	CREE	CREE	CREE	CREE	CREE
Size(DxH)	Ø63x50mm	Ø73x61mm	Ø85x70mm	Ø105x88.5mm	Ø132x108.5mm

UGR	<9	<9	<9	<9	<9
CRI	≥80/≥90	≥80/≥90	≥80/≥90	≥80/≥90	≥80/≥90
Beam angle	10°/15°/24°/36°/50°	10°/15°/24°/36°/50°	10°/15°/24°/36°/50°	10°/15°/24°/36°/50°	10°/15°/24°/36°/50°

CCT	2700K/3000K/4000K/5000K	2700K/3000K/4000K/5000K	2700K/3000K/4000K/5000K	2700K/3000K/4000K/5000K	2700K/3000K/4000K/5000K
Life time	50000 h	50000 h	50000 h	50000 h	50000 h
IP	IP20	IP20	IP20	IP20	IP20



• Embedded - Focusing Type

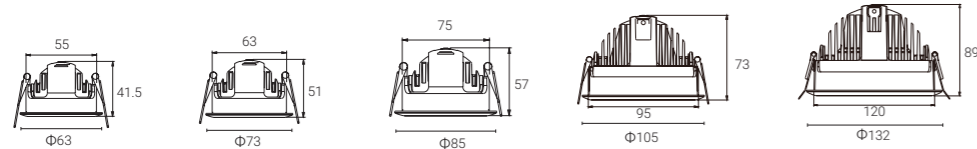

XQ-1001E55-BJ-LENS / XQ-1001E65-BJ-LENS / XQ-1001E75-BJ-LENS / XQ-1001E95-BJ-LENS / XQ-1001E120-BJ-LENS

Model Code	XQ-1001E55-BJ-LENS	XQ-1001E65-BJ-LENS	XQ-1001E75-BJ-LENS	XQ-1001E95-BJ-LENS	XQ-1001E120-BJ-LENS
Power	6W	8W	12W	18W	30W
Cut out	Φ55mm	Φ65mm	Φ75mm	Φ95mm	Φ120mm
Light Source	CREE	CREE	CREE	CREE	CREE
Size(DxH)	Ø63x41.5mm	Ø73x51mm	Ø85x57mm	Ø105x73mm	Ø132x89mm

UGR	<9	<9	<9	<9	<9
CRI	≥80/≥90	≥80/≥90	≥80/≥90	≥80/≥90	≥80/≥90
Beam angle	15~36°	15~36°	15~36°	15~36°	15~36°

CCT	2700K/3000K/4000K/5000K	2700K/3000K/4000K/5000K	2700K/3000K/4000K/5000K	2700K/3000K/4000K/5000K	2700K/3000K/4000K/5000K
Life time	50000 h	50000 h	50000 h	50000 h	50000 h
IP	IP20	IP20	IP20	IP20	IP20



• Trimless-Lens

Colour:



Optional :

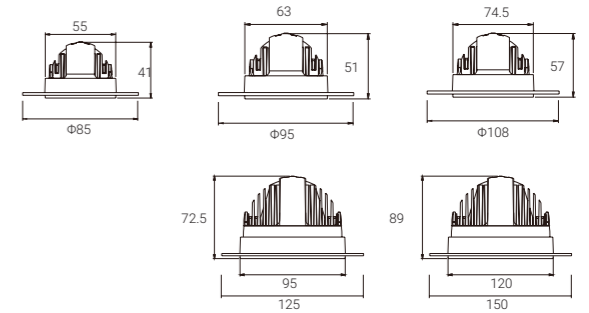

XQ-1001T55-PK-LENS / XQ-1001T65-PK-LENS / XQ-1001T75-PK-LENS / XQ-1001T95-PK-LENS / XQ-1001T120-PK-LENS

Model Code	XQ-1001T55-PK-LENS	XQ-1001T65-PK-LENS	XQ-1001T75-PK-LENS	XQ-1001T95-PK-LENS	XQ-1001T120-PK-LENS
Power	6W	8W	12W	18W	30W
Cut out	Φ55mm	Φ65mm	Φ75mm	Φ95mm	Φ120mm
Light Source	CREE	CREE	CREE	CREE	CREE
Size(DxH)	Ø85x41mm	Ø95x51mm	Ø108x57mm	Ø125x72.5mm	Ø150x89mm

UGR	<13	<13	<13	<13	<13
CRI	≥80/≥90	≥80/≥90	≥80/≥90	≥80/≥90	≥80/≥90
Beam angle	10°/15°/ 24°/ 36°/ 50°	10°/15°/ 24°/ 36°/ 50°	10°/15°/ 24°/ 36°/ 50°	10°/15°/ 24°/ 36°/ 50°	10°/15°/ 24°/ 36°/ 50°

CCT	2700K/3000K/4000K/5000K	2700K/3000K/4000K/5000K	2700K/3000K/4000K/5000K	2700K/3000K/4000K/5000K	2700K/3000K/4000K/5000K
Life time	50000 h	50000 h	50000 h	50000 h	50000 h
IP	IP20/IP44	IP20/IP44	IP20/IP44	IP20/IP44	IP20/IP44



• Trimless-Snout Type

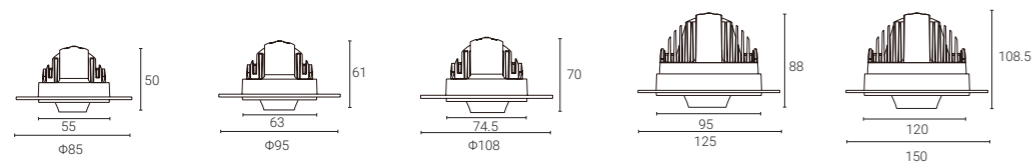

XQ-1001T55-ZY-LENS / XQ-1001T65-ZY-LENS / XQ-1001T75-ZY-LENS / XQ-1001T95-ZY-LENS / XQ-1001T120-ZY-LENS

Model Code	XQ-1001T55-ZY-LENS	XQ-1001T65-ZY-LENS	XQ-1001T75-ZY-LENS	XQ-1001T95-ZY-LENS	XQ-1001T120-ZY-LENS
Power	6W	8W	12W	18W	30W
Cut out	Φ55mm	Φ65mm	Φ75mm	Φ95mm	Φ120mm
Light Source	CREE	CREE	CREE	CREE	CREE
Size(DxH)	Ø85x50mm	Ø95x61mm	Ø108x70mm	Ø125x88mm	Ø150x108.5mm

UGR	<9	<9	<9	<9	<9
CRI	≥80/≥90	≥80/≥90	≥80/≥90	≥80/≥90	≥80/≥90
Beam angle	10°/15°/24°/36°/50°	10°/15°/24°/36°/50°	10°/15°/24°/36°/50°	10°/15°/24°/36°/50°	10°/15°/24°/36°/50°

CCT	2700K/3000K/4000K/5000K	2700K/3000K/4000K/5000K	2700K/3000K/4000K/5000K	2700K/3000K/4000K/5000K	2700K/3000K/4000K/5000K
Life time	50000 h	50000 h	50000 h	50000 h	50000 h
IP	IP20	IP20	IP20	IP20	IP20



• Single headed Square-Lens

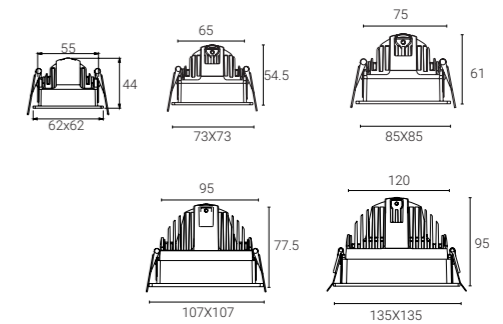
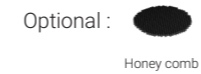

XQ-1001P55-PK-LENS / XQ-1001P65-PK-LENS / XQ-1001P75-PK-LENS / XQ-1001P95-PK-LENS / XQ-1001P120-PK-LENS

Model Code	XQ-1001P55-PK-LENS	XQ-1001P65-PK-LENS	XQ-1001P75-PK-LENS	XQ-1001P95-PK-LENS	XQ-1001P120-PK-LENS
Power	6W	8W	12W	18W	30W
Cut out	55x55mm	65x65mm	75x75mm	95x95mm	120x120mm
Light Source	CREE	CREE	CREE	CREE	CREE
Size(DxH)	62x62x44mm	73x73x54.5mm	85x85x61mm	107x107x77.5mm	135x135x95mm

UGR	<13	<13	<13	<13	<13
CRI	≥80/≥90	≥80/≥90	≥80/≥90	≥80/≥90	≥80/≥90
Beam angle	10°/15°/ 24°/ 36°/ 50°	10°/15°/ 24°/ 36°/ 50°	10°/15°/ 24°/ 36°/ 50°	10°/15°/ 24°/ 36°/ 50°	10°/15°/ 24°/ 36°/ 50°

CCT	2700K/3000K/4000K/5000K	2700K/3000K/4000K/5000K	2700K/3000K/4000K/5000K	2700K/3000K/4000K/5000K	2700K/3000K/4000K/5000K
Life time	50000 h	50000 h	50000 h	50000 h	50000 h
IP	IP20/IP44	IP20/IP44	IP20/IP44	IP20/IP44	IP20/IP44



• Single headed Square-Reflector

Colour:



Optional :

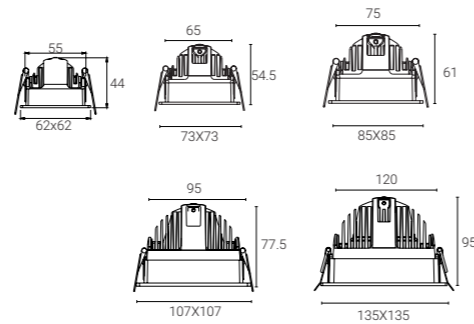

XQ-1001P55-PK-FGB / XQ-1001P65-PK-FGB/ XQ-1001P75-PK-FGB/ XQ-1001P95-PK-FGB/ XQ-1001P120-PK-FGB

Model Code	XQ-1001P55-PK-FGB	XQ-1001P65-PK-FGB	XQ-1001P75-PK-FGB	XQ-1001P95-PK-FGB	XQ-1001P120-PK-FGB
Power	6W	8W	12W	18W	30W
Cut out	55x55mm	65x65mm	75x75mm	95x95mm	120x120mm
Light Source	CREE	CREE	CREE	CREE	CREE
Size(DxH)	62X62x44mm	73X73x54.5mm	85X85x61mm	107X107x77.5mm	135X135x95mm

UGR	<13	<13	<13	<13	<13
CRI	≥80/≥90	≥80/≥90	≥80/≥90	≥80/≥90	≥80/≥90
Beam angle	18°/ 24°/ 38°	18°/ 24°/ 38°	18°/ 24°/ 38°	18°/ 24°/ 38°	18°/ 24°/ 38°

CCT	2700K/3000K/4000K/5000K	2700K/3000K/4000K/5000K	2700K/3000K/4000K/5000K	2700K/3000K/4000K/5000K	2700K/3000K/4000K/5000K
Life time	50000 h	50000 h	50000 h	50000 h	50000 h
IP	IP20/IP44	IP20/IP44	IP20/IP44	IP20/IP44	IP20/IP44



• Single headed Square-Black Hole Type

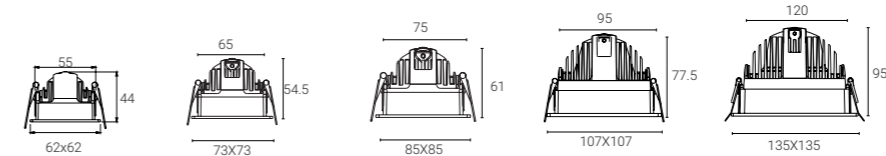

XQ-1001P55-HD / XQ-1001P65-HD / XQ-1001P75-HD / XQ-1001P95-HD / XQ-1001P120-HD

Model Code	XQ-1001P55-HD	XQ-1001P65-HD	XQ-1001P75-HD	XQ-1001P95-HD	XQ-1001P120-HD
Power	5W	7W	9W	15W	25W
Cut out	55x55mm	65x65mm	75x75mm	95x95mm	120x120mm
Light Source	CREE	CREE	CREE	CREE	CREE
Size(DxH)	62x62x44mm	73x73x54.5mm	85x85x61mm	107x107x77.5mm	135x135x95mm

UGR	<9	<9	<9	<9	<9
CRI	≥80/≥90	≥80/≥90	≥80/≥90	≥80/≥90	≥80/≥90
Beam angle	24°/36°	24°/36°	24°/36°	24°/36°	24°/36°

CCT	2700K/3000K/4000K/5000K	2700K/3000K/4000K/5000K	2700K/3000K/4000K/5000K	2700K/3000K/4000K/5000K	2700K/3000K/4000K/5000K
Life time	50000 h	50000 h	50000 h	50000 h	50000 h
IP	IP20	IP20	IP20	IP20	IP20



• Single headed Square-Snout Type

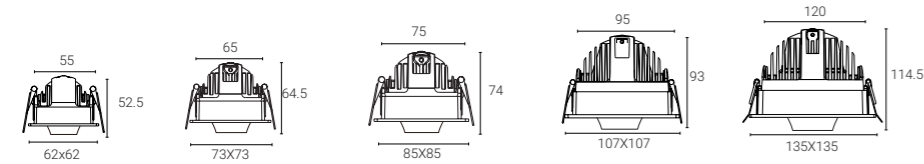

XQ-1001P55-ZY-LENS / XQ-1001P65-ZY-LENS / XQ-1001P75-ZY-LENS / XQ-1001P95-ZY-LENS / XQ-1001P120-ZY-LENS

Model Code	XQ-1001P55-ZY-LENS	XQ-1001P65-ZY-LENS	XQ-1001P75-ZY-LENS	XQ-1001P95-ZY-LENS	XQ-1001P120-ZY-LENS
Power	6W	8W	12W	18W	30W
Cut out	55x55mm	65x65mm	75x75mm	95x95mm	120x120mm
Light Source	CREE	CREE	CREE	CREE	CREE
Size(DxH)	62x62x52.5mm	73x73x64.5mm	85x85x74mm	107x107x93mm	135x135x114.5mm
UGR	<9	<9	<9	<9	<9
CRI	≥80/≥90	≥80/≥90	≥80/≥90	≥80/≥90	≥80/≥90
Beam angle	10°/15°/24°/36°/50°	10°/15°/24°/36°/50°	10°/15°/24°/36°/50°	10°/15°/24°/36°/50°	10°/15°/24°/36°/50°
CCT	2700K/3000K/4000K/5000K	2700K/3000K/4000K/5000K	2700K/3000K/4000K/5000K	2700K/3000K/4000K/5000K	2700K/3000K/4000K/5000K
Life time	50000 h	50000 h	50000 h	50000 h	50000 h
IP	IP20	IP20	IP20	IP20	IP20



• Single headed Square-Acrylic Type

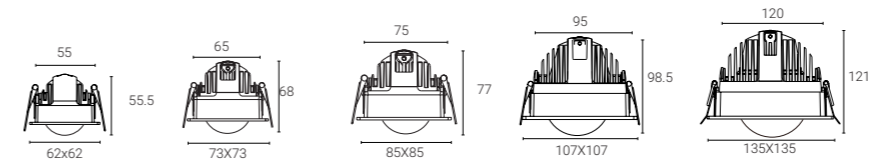

XQ-1001P55-FG-FGB / XQ-1001P65-FG-FGB / XQ-1001P75-FG-FGB / XQ-1001P95-FG-FGB / XQ-1001P120-FG-FGB

Model Code	XQ-1001P55-FG-FGB	XQ-1001P65-FG-FGB	XQ-1001P75-FG-FGB	XQ-1001P95-FG-FGB	XQ-1001P120-FG-FGB
Power	6W	8W	12W	18W	30W
Cut out	55x55mm	65x65mm	75x75mm	95x95mm	120x120mm
Light Source	CREE	CREE	CREE	CREE	CREE
Size(DxH)	62x62x55.5mm	73x73x68mm	85x85x77mm	107x107mm	135x135mm
UGR	-	-	-	-	-
CRI	≥80/≥90	≥80/≥90	≥80/≥90	≥80/≥90	≥80/≥90
Beam angle	120°	120°	120°	120°	120°
CCT	2700K/3000K/4000K/5000K	2700K/3000K/4000K/5000K	2700K/3000K/4000K/5000K	2700K/3000K/4000K/5000K	2700K/3000K/4000K/5000K
Life time	50000 h	50000 h	50000 h	50000 h	50000 h
IP	IP20	IP20	IP20	IP20	IP20



• Single headed Square-Focusing Type

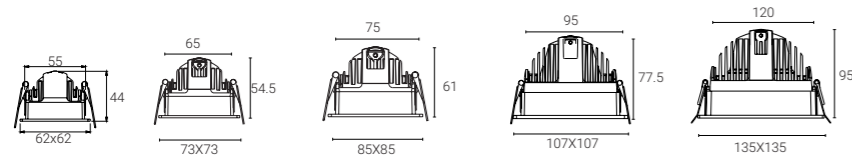

XQ-1001P55-BJ-LENS / XQ-1001P65-BJ-LENS / XQ-1001P75-BJ-LENS / XQ-1001P95-BJ-LENS / XQ-1001P120-BJ-LENS

Model Code	XQ-1001P55-BJ-LENS	XQ-1001P65-BJ-LENS	XQ-1001P75-BJ-LENS	XQ-1001P95-BJ-LENS	XQ-1001P120-BJ-LENS
Power	6W	8W	12W	18W	30W
Cut out	55x55mm	65x65mm	75x75mm	95x95mm	120x120mm
Light Source	CREE	CREE	CREE	CREE	CREE
Size(DxH)	62x62x44mm	73x73x54.5mm	85x85x61mm	107x107x77.5mm	135x135x95mm

UGR	<9	<9	<9	<9	<9
CRI	≥80/≥90	≥80/≥90	≥80/≥90	≥80/≥90	≥80/≥90
Beam angle	15~36°	15~36°	15~36°	15~36°	15~36°

CCT	2700K/3000K/4000K/5000K	2700K/3000K/4000K/5000K	2700K/3000K/4000K/5000K	2700K/3000K/4000K/5000K	2700K/3000K/4000K/5000K
Life time	50000 h	50000 h	50000 h	50000 h	50000 h
IP	IP20	IP20	IP20	IP20	IP20



• Double headed Square-Lens

Colour: Gold Chrom Black White Silver Pearl black

Optional : Honey comb

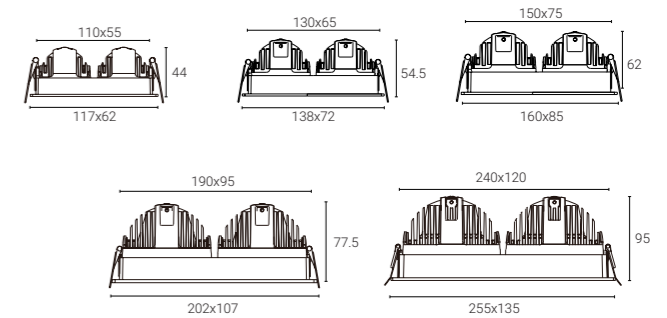

XQ-1001P55-PK-2-LENS / XQ-1001P65-PK-2-LENS / XQ-1001P75-PK-2-LENS / XQ-1001P95-PK-2-LENS / XQ-1001P120-PK-2-LENS

Model Code	XQ-1001P55-PK-2-LENS	XQ-1001P65-PK-2-LENS	XQ-1001P75-PK-2-LENS	XQ-1001P95-PK-2-LENS	XQ-1001P120-PK-2-LENS
Power	6W	8W	12W	18W	30W
Cut out	110x55mm	130x65mm	150x75mm	190x95mm	240x120mm
Light Source	CREE	CREE	CREE	CREE	CREE
Size(DxH)	117x62x44mm	138x72x54.5mm	160x85x61mm	202x107x77.5mm	255x135x95mm

UGR	<13	<13	<13	<13	<13
CRI	≥80/≥90	≥80/≥90	≥80/≥90	≥80/≥90	≥80/≥90
Beam angle	10°/15°/ 24°/ 36°/ 50°	10°/15°/ 24°/ 36°/ 50°	10°/15°/ 24°/ 36°/ 50°	10°/15°/ 24°/ 36°/ 50°	10°/15°/ 24°/ 36°/ 50°

CCT	2700K/3000K/4000K/5000K	2700K/3000K/4000K/5000K	2700K/3000K/4000K/5000K	2700K/3000K/4000K/5000K	2700K/3000K/4000K/5000K
Life time	50000 h	50000 h	50000 h	50000 h	50000 h
IP	IP20/IP44	IP20/IP44	IP20/IP44	IP20/IP44	IP20/IP44



● Double headed Square-Reflector

Colour:



Optional :



Honey comb

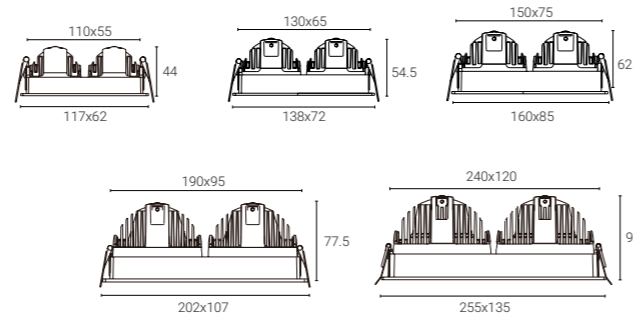

● Double headed Square-Black Hole Type

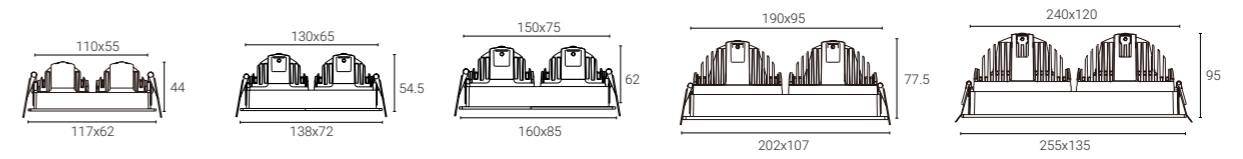

XQ-1001P55-PK-FGB / XQ-1001P65-PK-FGB/ XQ-1001P75-PK-FGB/ XQ-1001P95-PK-FGB/ XQ-1001P120-PK-FGB

Model Code	XQ-1001P55-PK-2-FGB	XQ-1001P65-PK-2-FGB	XQ-1001P75-PK-2-FGB	XQ-1001P95-PK-2-FGB	XQ-1001P120-PK-2-FGB
Power	6W	8W	12W	18W	30W
Cut out	110x55mm	130x65mm	150x75mm	190x95mm	240x120mm
Light Source	CREE	CREE	CREE	CREE	CREE
Size(DxH)	117x62x44mm	138x72x54.5mm	160x85x61mm	202x107x77.5mm	255x135x95mm
UGR	<13	<13	<13	<13	<13
CRI	≥80/≥90	≥80/≥90	≥80/≥90	≥80/≥90	≥80/≥90
Beam angle	18°/ 24°/ 38°	18°/ 24°/ 38°	18°/ 24°/ 38°	18°/ 24°/ 38°	18°/ 24°/ 38°
CCT	2700K/3000K/4000K/5000K	2700K/3000K/4000K/5000K	2700K/3000K/4000K/5000K	2700K/3000K/4000K/5000K	2700K/3000K/4000K/5000K
Life time	50000 h	50000 h	50000 h	50000 h	50000 h
IP	IP20/IP44	IP20/IP44	IP20/IP44	IP20/IP44	IP20/IP44

XQ-1001P55-HD-2 / XQ-1001P65-HD-2 / XQ-1001P75-HD-2 / XQ-1001P95-HD-2 / XQ-1001P120-HD-2

Model Code	XQ-1001P55-HD-2	XQ-1001P65-HD-2	XQ-1001P75-HD-2	XQ-1001P95-HD-2	XQ-1001P120-HD-2
Power	5W	7W	9W	15W	25W
Cut out	110x55mm	130x65mm	150x75mm	190x95mm	240x120mm
Light Source	CREE	CREE	CREE	CREE	CREE
Size(DxH)	6117x62x44mm	138x72x54.5mm	160x85x62mm	202x107x77.5mm	255x135x95mm
UGR	<9	<9	<9	<9	<9
CRI	≥80/≥90	≥80/≥90	≥80/≥90	≥80/≥90	≥80/≥90
Beam angle	24°/36°	24°/36°	24°/36°	24°/36°	24°/36°
CCT	2700K/3000K/4000K/5000K	2700K/3000K/4000K/5000K	2700K/3000K/4000K/5000K	2700K/3000K/4000K/5000K	2700K/3000K/4000K/5000K
Life time	50000 h	50000 h	50000 h	50000 h	50000 h
IP	IP20	IP20	IP20	IP20	IP20

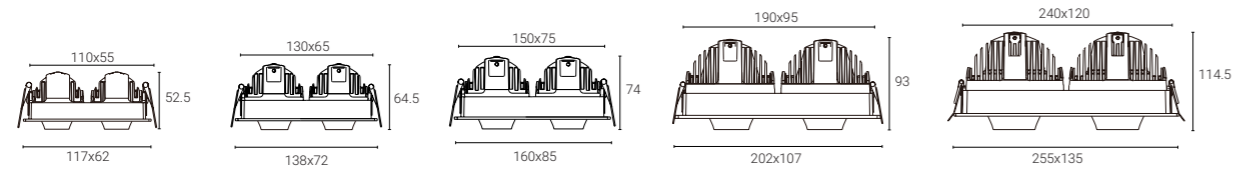

XQ-1001P55-ZY-2-LENS / XQ-1001P65-ZY-2-LENS / XQ-1001P75-ZY-2-LENS / XQ-1001P95-ZY-2-LENS / XQ-1001P120-ZY-2-LENS

Model Code	XQ-1001P55-ZY-2-LENS	XQ-1001P65-ZY-2-LENS	XQ-1001P75-ZY-2-LENS	XQ-1001P95-ZY-2-LENS	XQ-1001P120-ZY-2-LENS
Power	6W	8W	12W	18W	30W
Cut out	110x55mm	130x65mm	150x75mm	190x95mm	240x120mm
Light Source	CREE	CREE	CREE	CREE	CREE
Size(DxH)	117x62x52.5mm	138x72x64.5mm	160x85x74mm	202x107x93mm	255x135x114.5mm

UGR	<9	<9	<9	<9	<9
CRI	≥80/≥90	≥80/≥90	≥80/≥90	≥80/≥90	≥80/≥90
Beam angle	10°/15°/24°/36°/50°	10°/15°/24°/36°/50°	10°/15°/24°/36°/50°	10°/15°/24°/36°/50°	10°/15°/24°/36°/50°

CCT	2700K/3000K/4000K/5000K	2700K/3000K/4000K/5000K	2700K/3000K/4000K/5000K	2700K/3000K/4000K/5000K	2700K/3000K/4000K/5000K
Life time	50000 h	50000 h	50000 h	50000 h	50000 h
IP	IP20	IP20	IP20	IP20	IP20

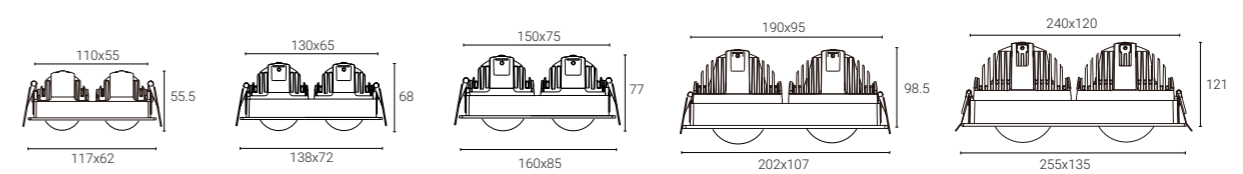
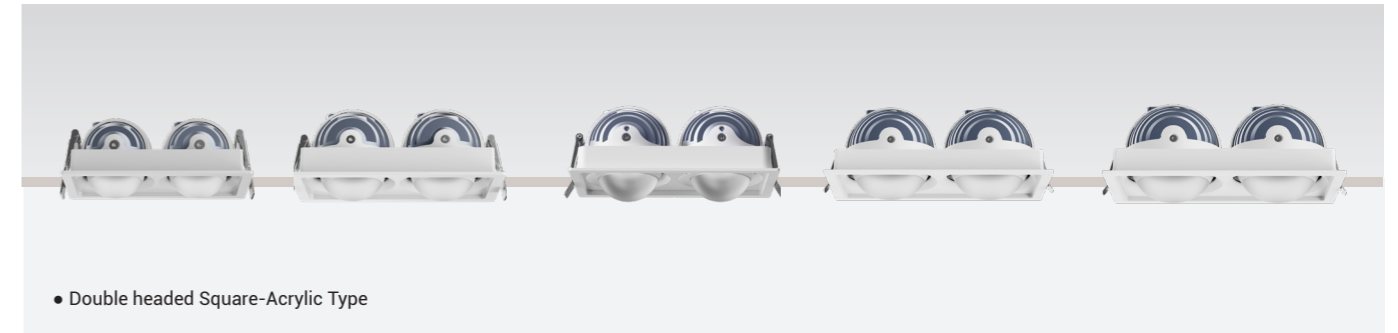

XQ-1001P55-FG-2-FGB / XQ-1001P65-FG-2-FGB / XQ-1001P75-FG-2-FGB / XQ-1001P95-FG-2-FGB / XQ-1001P120-FG-2-FGB

Model Code	XQ-1001P55-FG-2-FGB	XQ-1001P65-FG-2-FGB	XQ-1001P75-FG-2-FGB	XQ-1001P95-FG-2-FGB	XQ-1001P120-FG-2-FGB
Power	6W	8W	12W	18W	30W
Cut out	110x55mm	130x65mm	150x75mm	192x95mm	240x120mm
Light Source	CREE	CREE	CREE	CREE	CREE
Size(DxH)	117x62x55.5mm	138x72x68mm	160x85x77mm	202x107x98.5mm	255x135x121mm

UGR	-	-	-	-	-
CRI	≥80/≥90	≥80/≥90	≥80/≥90	≥80/≥90	≥80/≥90
Beam angle	120°	120°	120°	120°	120°

CCT	2700K/3000K/4000K/5000K	2700K/3000K/4000K/5000K	2700K/3000K/4000K/5000K	2700K/3000K/4000K/5000K	2700K/3000K/4000K/5000K
Life time	50000 h	50000 h	50000 h	50000 h	50000 h
IP	IP20	IP20	IP20	IP20	IP20

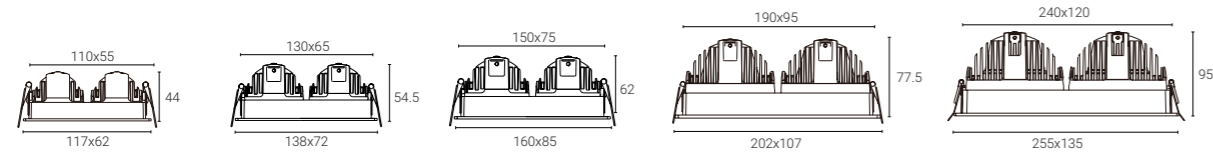

XQ-1001P55-BJ-2-LENS / XQ-1001P65-BJ-2-LENS / XQ-1001P75-BJ-2-LENS / XQ-1001P95-BJ-2-LENS / XQ-1001P120-BJ-2-LENS

Model Code	XQ-1001P55-BJ-2-LENS	XQ-1001P65-BJ-2-LENS	XQ-1001P75-BJ-2-LENS	XQ-1001P95-BJ-2-LENS	XQ-1001P120-BJ-2-LENS
Power	6W	8W	12W	18W	30W
Cut out	110x55mm	130x65mm	150x75mm	192x95mm	240x120mm
Light Source	CREE	CREE	CREE	CREE	CREE
Size(DxH)	62x62x44mm	73x73x54.5mm	85x85x61mm	107x107x77.5mm	135x135x95mm

UGR	<9	<9	<9	<9	<9
CRI	≥80/≥90	≥80/≥90	≥80/≥90	≥80/≥90	≥80/≥90
Beam angle	15~36°	15~36°	15~36°	15~36°	15~36°

CCT	2700K/3000K/4000K/5000K	2700K/3000K/4000K/5000K	2700K/3000K/4000K/5000K	2700K/3000K/4000K/5000K	2700K/3000K/4000K/5000K
Life time	50000 h	50000 h	50000 h	50000 h	50000 h
IP	IP20	IP20	IP20	IP20	IP20

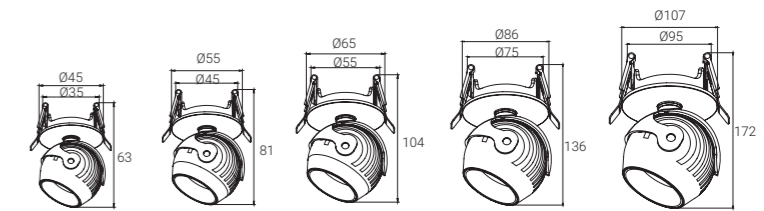
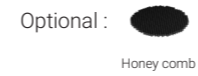

XQ-1001E55-DZ-LENS / XQ-1001E65-DZ-LENS / XQ-1001E75-DZ-LENS / XQ-1001E95-DZ-LENS / XQ-1001E120-DZ-LENS

Model Code	XQ-1001E55-DZ-LENS	XQ-1001E65-DZ-LENS	XQ-1001E75-DZ-LENS	XQ-1001E95-DZ-LENS	XQ-1001E120-DZ-LENS
Power	6W	8W	12W	18W	30W
Cut out	Ø35mm	Ø45mm	Ø55mm	Ø75mm	Ø95mm
Light Source	CREE	CREE	CREE	CREE	CREE
Size(DxH)	Ø45x63mm	Ø55x81mm	Ø65x104mm	Ø86x136mm	Ø107x172mm

UGR	<13	<13	<13	<13	<13
CRI	≥80/≥90	≥80/≥90	≥80/≥90	≥80/≥90	≥80/≥90
Beam angle	10°/15°/ 24°/ 36°/ 50°	10°/15°/ 24°/ 36°/ 50°	10°/15°/ 24°/ 36°/ 50°	10°/15°/ 24°/ 36°/ 50°	10°/15°/ 24°/ 36°/ 50°

CCT	2700K/3000K/4000K/5000K	2700K/3000K/4000K/5000K	2700K/3000K/4000K/5000K	2700K/3000K/4000K/5000K	2700K/3000K/4000K/5000K
Life time	50000 h	50000 h	50000 h	50000 h	50000 h
IP	IP20/IP44	IP20/IP44	IP20/IP44	IP20/IP44	IP20/IP44



• Pendant embedded-Reflector

- Colour:
- Gold
 - Chorm
 - Black
 - White
 - Silver
 - Pearl black
- Optional :
- Honey comb

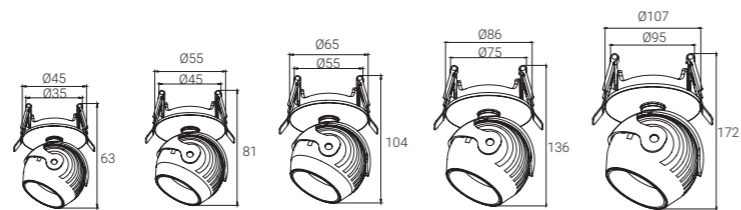

XQ-1001E55-DZ-FGB / XQ-1001E65-DZ-FGB/ XQ-1001E75-DZ-FGB/ XQ-1001E95-DZ-FGB/ XQ-1001E120-DZ-FGB

Model Code	XQ-1001E55-DZ-FGB	XQ-1001E65-DZ-FGB	XQ-1001E75-DZ-FGB	XQ-1001E95-DZ-FGB	XQ-1001E120-DZ-FGB
Power	6W	8W	12W	18W	30W
Cut out	Ø35mm	Ø45mm	Ø55mm	Ø75mm	Ø95mm
Light Source	CREE	CREE	CREE	CREE	CREE
Size(DxH)	Ø45x63mm	Ø55x81mm	Ø65x104mm	Ø86x136mm	Ø107x172mm

UGR	<13	<13	<13	<13	<13
CRI	≥80/≥90	≥80/≥90	≥80/≥90	≥80/≥90	≥80/≥90
Beam angle	18°/ 24°/ 38°	18°/ 24°/ 38°	18°/ 24°/ 38°	18°/ 24°/ 38°	18°/ 24°/ 38°

CCT	2700K/3000K/4000K/5000K	2700K/3000K/4000K/5000K	2700K/3000K/4000K/5000K	2700K/3000K/4000K/5000K	2700K/3000K/4000K/5000K
Life time	50000 h	50000 h	50000 h	50000 h	50000 h
IP	IP20/IP44	IP20/IP44	IP20/IP44	IP20/IP44	IP20/IP44

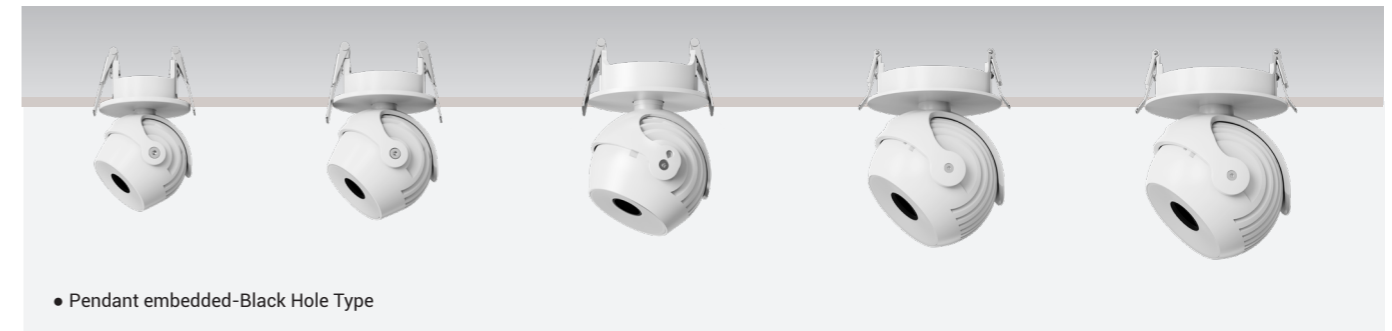

• Pendant embedded-Black Hole Type

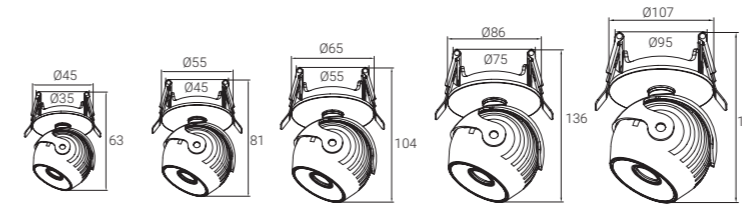

XQ-1001E55-DZ-HD / XQ-1001E65-DZ-HD / XQ-1001E75-DZ-HD / XQ-1001E95-DZ-HD / XQ-1001E120-DZ-HD

Model Code	XQ-1001E55-DZ-HD	XQ-1001E65-DZ-HD	XQ-1001E75-DZ-HD	XQ-1001E95-DZ-HD	XQ-1001E120-DZ-HD
Power	5W	7W	9W	15W	25W
Cut out	Ø35mm	Ø45mm	Ø55mm	Ø75mm	Ø95mm
Light Source	CREE	CREE	CREE	CREE	CREE
Size(DxH)	Ø45x63mm	Ø55x81mm	Ø65x104mm	Ø86x136mm	Ø107x172mm

UGR	<9	<9	<9	<9	<9
CRI	≥80/≥90	≥80/≥90	≥80/≥90	≥80/≥90	≥80/≥90
Beam angle	10°/15°/ 24°/ 36°/ 50°	24°/36°	24°/36°	24°/36°	24°/36°

CCT	2700K/3000K/4000K/5000K	2700K/3000K/4000K/5000K	2700K/3000K/4000K/5000K	2700K/3000K/4000K/5000K	2700K/3000K/4000K/5000K
Life time	50000 h	50000 h	50000 h	50000 h	50000 h
IP	IP20	IP20	IP20	IP20	IP20



• Pendant embedded-Snout Type

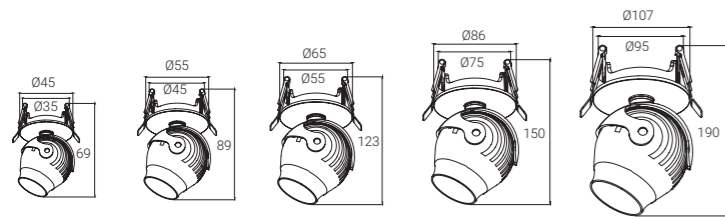

XQ-1001E55-DZ-ZY-LENS / XQ-1001E65-DZ-ZY-LENS / XQ-1001E75-DZ-ZY-LENS / XQ-1001E95-DZ-ZY-LENS/ XQ-1001E120-DZ-ZY-LENS

Model Code	XQ-1001E55-DZ-ZY-LENS	XQ-1001E65-DZ-ZY-LENS	XQ-1001E75-DZ-ZY-LENS	XQ-1001E95-DZ-ZY-LENS	XQ-1001E120-DZ-ZY-LENS
Power	6W	8W	12W	18W	30W
Cut out	Ø35mm	Ø45mm	Ø55mm	Ø75mm	Ø95mm
Light Source	CREE	CREE	CREE	CREE	CREE
Size(DxH)	Ø45x69mm	Ø55x59mm	Ø65x123mm	Ø86x150mm	Ø107x190mm

UGR	<9	<9	<9	<9	<9
CRI	≥80/≥90	≥80/≥90	≥80/≥90	≥80/≥90	≥80/≥90
Beam angle	10°/15°/ 24°/ 36°/ 50°	10°/15°/ 24°/ 36°/ 50°	10°/15°/ 24°/ 36°/ 50°	10°/15°/ 24°/ 36°/ 50°	10°/15°/ 24°/ 36°/ 50°

CCT	2700K/3000K/4000K/5000K	2700K/3000K/4000K/5000K	2700K/3000K/4000K/5000K	2700K/3000K/4000K/5000K	2700K/3000K/4000K/5000K
Life time	50000 h	50000 h	50000 h	50000 h	50000 h
IP	IP20	IP20	IP20	IP20	IP20



• Pendant embedded-Acrylic Type

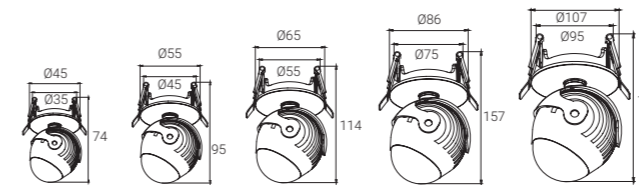

XQ-1001E55-DZ-FG-FGB / XQ-1001E65-DZ-FG-FGB / XQ-1001E75-DZ-FG-FGB / XQ-1001E95-DZ-FG-FGB / XQ-1001E120-DZ-FG-FGB

Model Code	XQ-1001E55-DZ-FG-FGB	XQ-1001E65-DZ-FG-FGB	XQ-1001E75-DZ-FG-FGB	XQ-1001E95-DZ-FG-FGB	XQ-1001E120-DZ-FG-FGB
Power	6W	8W	12W	18W	30W
Cut out	Ø35mm	Ø45mm	Ø55mm	Ø75mm	Ø95mm
Light Source	CREE	CREE	CREE	CREE	CREE
Size(DxH)	Ø45x74mm	Ø55x95mm	Ø65x114mm	Ø86x157mm	Ø107x199mm

UGR	-	-	-	-	-
CRI	≥80/≥90	≥80/≥90	≥80/≥90	≥80/≥90	≥80/≥90
Beam angle	120°	120°	120°	120°	120°

CCT	2700K/3000K/4000K/5000K	2700K/3000K/4000K/5000K	2700K/3000K/4000K/5000K	2700K/3000K/4000K/5000K	2700K/3000K/4000K/5000K
Life time	50000 h	50000 h	50000 h	50000 h	50000 h
IP	IP20	IP20	IP20	IP20	IP20

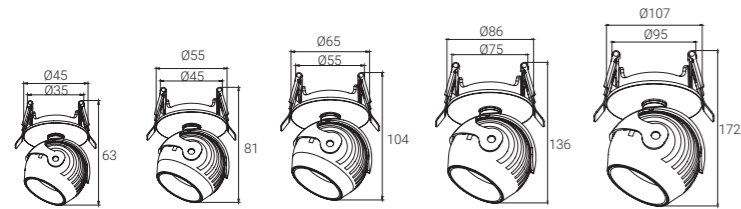

XQ-1001E55-DZ-BJ-LENS / XQ-1001E65-DZ-BJ-LENS/ XQ-1001E75-DZ-BJ-LENS/ XQ-1001E95-DZ-BJ-LENS/ XQ-1001E120-DZ-BJ-LENS

Model Code	XQ-1001E55-DZ-BJ-LENS	XQ-1001E65-DZ-BJ-LENS	XQ-1001E75-DZ-BJ-LENS	XQ-1001E95-DZ-BJ-LENS	XQ-1001E120-DZ-BJ-LENS
Power	6W	8W	12W	18W	30W
Cut out	Ø35mm	Ø45mm	Ø55mm	Ø75mm	Ø95mm
Light Source	CREE	CREE	CREE	CREE	CREE
Size(DxH)	Ø45x63mm	Ø55x81mm	Ø65x104mm	Ø86x136mm	Ø107x172mm

UGR	<9	<9	<9	<9	<9
CRI	≥80/≥90	≥80/≥90	≥80/≥90	≥80/≥90	≥80/≥90
Beam angle	15~36°	15~36°	15~36°	15~36°	15~36°

CCT	2700K/3000K/4000K/5000K	2700K/3000K/4000K/5000K	2700K/3000K/4000K/5000K	2700K/3000K/4000K/5000K	2700K/3000K/4000K/5000K
Life time	50000 h	50000 h	50000 h	50000 h	50000 h
IP	IP20	IP20	IP20	IP20	IP20

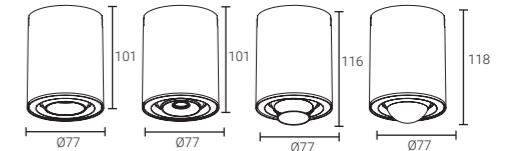
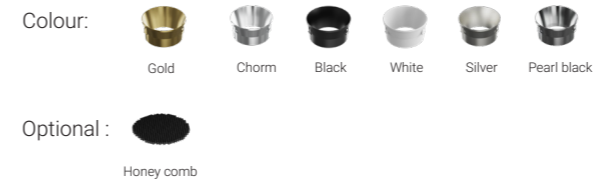

XQ-1001R75-MZ-LENS / XQ-1001R75-MZ-FGB / XQ-1001R75-MZ-HD / XQ-1001R75-MZ-ZY / XQ-1001R75-MZ-FG / XQ-1001R75-MZ-BJ

Model Code	XQ-1001R75-MZ-LENS	XQ-1001R75-MZ-FGB	XQ-1001R75-MZ-HD	XQ-1001R75-MZ-ZY	XQ-1001R75-MZ-FG	XQ-1001R75-MZ-BJ
Power	12W	12W	9W	12W	12W	12W
Installation	Surface	Surface	Surface	Surface	Surface	Surface
Light Source	CREE	CREE	CREE	CREE	CREE	CREE
Size(DxH)	Ø77x101mm	Ø77x101mm	Ø77x101mm	Ø77x116mm	Ø77x118mm	Ø77x101mm

UGR	<13	<13	<9	<9	-	<9
CRI	≥80/≥90	≥80/≥90	≥80/≥90	≥80/≥90	≥80/≥90	≥80/≥90
Beam angle	10°/15°/ 24°/ 36°/ 50°	18°/ 24°/ 38°	24°/36°	10°/15°/ 24°/ 36°/ 50°	120°	15~36°

CCT	2700K/3000K/4000K/5000K	2700K/3000K/4000K/5000K	2700K/3000K/4000K/5000K	2700K/3000K/4000K/5000K	2700K/3000K/4000K/5000K	2700K/3000K/4000K/5000K
Life time	50000 h	50000 h	50000 h	50000 h	50000 h	50000 h
IP	IP20/IP44	IP20/IP44	IP20	IP20	IP20	IP20

ALIEN

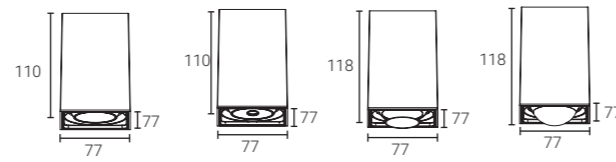
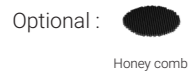

XQ-1001S75-MZ-LENS / XQ-1001S75-MZ-FGB / XQ-1001S75-MZ-HD / XQ-1001S75-MZ-ZY / XQ-1001S75-MZ-FG / XQ-1001S75-MZ-BJ

Model Code	XQ-1001S75-MZ-LENS	XQ-1001S75-MZ-FGB	XQ-1001S75-MZ-HD	XQ-1001S75-MZ-ZY	XQ-1001S75-MZ-FG	XQ-1001S75-MZ-BJ
Power	12W	12W	9W	12W	12W	12W
Installation	Surface	Surface	Surface	Surface	Surface	Surface
Light Source	CREE	CREE	CREE	CREE	CREE	CREE
Size(DxH)	Ø77x110mm	Ø77x110mm	Ø77x110mm	Ø77x118mm	Ø77x118mm	Ø77x110mm
UGR	<13	<13	<9	<9	-	<9
CRI	≥80/≥90	≥80/≥90	≥80/≥90	≥80/≥90	≥80/≥90	≥80/≥90
Beam angle	10°/15°/24°/36°/50°	18°/24°/38°	24°/36°	10°/15°/24°/36°/50°	120°	15~36°
CCT	2700K/3000K/4000K/5000K	2700K/3000K/4000K/5000K	2700K/3000K/4000K/5000K	2700K/3000K/4000K/5000K	2700K/3000K/4000K/5000K	2700K/3000K/4000K/5000K
Life time	50000 h	50000 h	50000 h	50000 h	50000 h	50000 h
IP	IP20/IP44	IP20/IP44	IP20	IP20	IP20	IP20

ALIEN