



Dartboard Cabinet Installation Instruction Manual

CPSIA#2-VT-DARTBOARD CABINET-

-VS

OWNER'S MANUAL

1. **Read this manual carefully before starting assembly.** Read each step completely before beginning each step.
2. **Check inside all parts and cartons before assembling or ordering parts.**
3. To make assembly as easy as possible, place all parts in a cleared area and remove the packaging material. Organize all parts as per parts identifier in the assembly manual. Do not dispose of the packing material until assembly is completed.
4. Avoid scratching dartboard cabinet parts during the assembly process.
5. Assemble product on clean, level and flat surface.
6. **Take time to correctly orientate parts exactly as per each assembly diagram.**
7. **Save this instruction in the event that the manufacturer has to be contacted for replacement parts.**



CAUTION:

**READ ASSEMBLY, OPERATING AND
SAFETY INSTRUCTIONS CAREFULLY!**

Thank you for buying our product. We try hard to ensure that our products are of high quality and free of problems, such as Manufacturing defects or missing parts. However, if you have any problems with your new product, please **DO NOT RETURN IT TO THE STORE!**

Limited 90-Day Victory Tailgate Warranty

All Victory Tailgate games have a limited 90-day from date of purchase warranty. This warrants the retail purchaser for any Victory Tailgate game purchased to be free from any defect in materials and construction for 90 days from the date of purchase. The only exceptions to the warranty include main frames, tabletops, playing surfaces, batteries or tools. Damaged main frames, tabletops, playing surfaces need to be returned to the store as we are unable to replace these parts. Normal play wear and usage is not covered under the warranty, nor is wear or damage due to improper use of the Victory Tailgate game. This will void any and all Victory Tailgate warranties.

Please Do Not Return This Product To The Store!

Contact Victory Tailgate customer service department at:

Phone: 1-888-577-4460 Toll-Free!

E-mail: info@victorytailgate.com

Mailing Address (correspondence only):

Victory Tailgate, LLC.

2437 East Landstreet Road, Orlando, FL 32824

Please provide model number and/or part number of the product and/or part when you call or write. These numbers can be found on the product, packaging, and/or in this Owner's Manual.

Please visit our website at: victorytailgate.com

ON-LINE TROUBLE SHOOTING







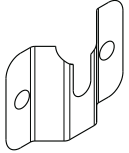
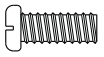

TECHNICAL ASSISTANCE

ON-LINE PARTS REQUESTS

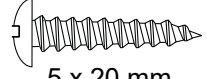
FREQUENTLY ASKED QUESTIONS

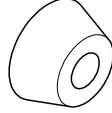
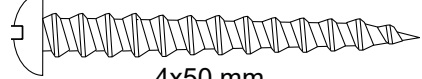
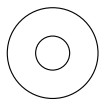
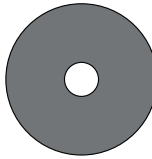
ADDITIONAL VICTORY TAILGATE PRODUCT INFORMATION

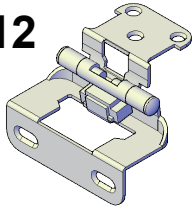
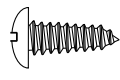
PARTS IDENTIFIER

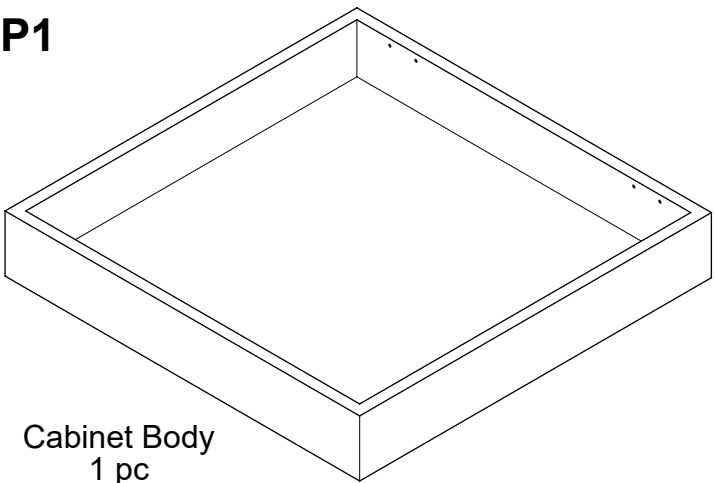
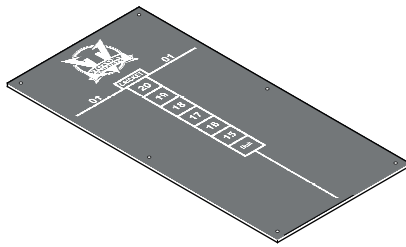
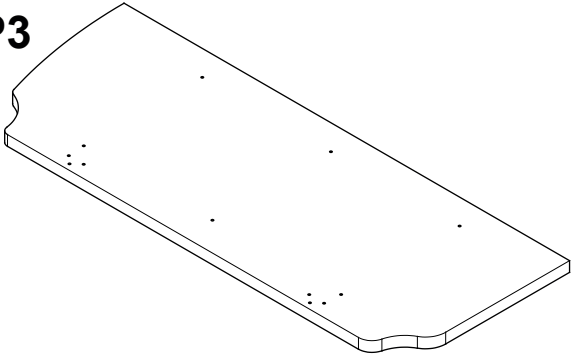
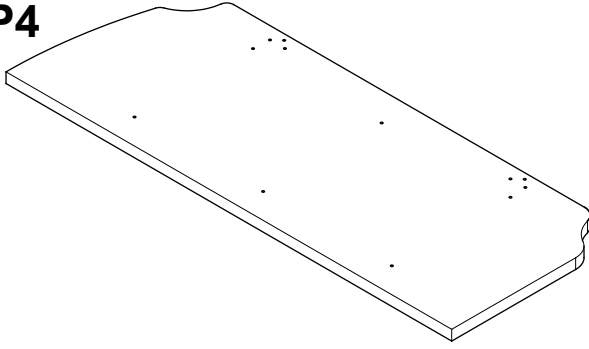
<p>H1</p>  <p>Mounting Bracket 1 pc</p>	<p>H2 (to scale)</p>  <p>3.5x10 mm Phillips Head Screw 2 pcs</p>	<p>H3 (to scale)</p>  <p>4 mm Flat Washer 2 pcs</p>	<p>H4 (to scale)</p>  <p>3 mm Nut 2 pcs</p>
<p>H5 (to scale)</p>  <p>5 x 20 mm Phillips Head Screw 1 pc</p>	<p>H6 (to scale)</p>  <p>1.5x18 mm Phillips Head Screw 3 pcs</p>	<p>H7</p>  <p>Bumper 3 pcs</p>	<p>H8 (to scale)</p>  <p>4x50 mm Phillips Head Screw 4 pcs</p>
<p>H9 (to scale)</p>  <p>4.5 mm Flat Washer 4 pcs</p>	<p>H10 (to scale)</p>  <p>20 mm EVA Pad (Peel & Stick) - 4 pcs (2 pcs customer installs & 2 pcs factory preinstalled)</p>		<p>H11</p>  <p>16" Template for Mounting Dart Cabinet - 1 pc</p>
<p>H12</p>  <p>Door Hinge - 4 pcs</p>	<p>H13 (to scale)</p>  <p>4x12mm Rounded Head Screw 28 pcs</p>	<p>H14 (to scale)</p>  <p>3x12mm Flat Head Screw 4 pcs</p>	
<p>P1</p>  <p>Cabinet Body 1 pc</p>		<p>P2</p>  <p>Scoreboard 2 pcs</p>	
<p>P3</p>  <p>Cabinet Door - Right 1 pc</p>	<p>P4</p>  <p>Cabinet Door - Left 1 pc</p>		

CABINET DOOR & SCOREBOARD INSTALLATION

Step.1 Install Scoreboard onto Cabinet Door

1. Align the 6 holes on **P2** Scoreboard onto **P3** Right Cabinet Door's 6 pilot holes.
2. Using 6 pcs **H13** Rounded Head Screw, screw **P2** Scoreboard onto Cabinet Door like shown on **Figure 1**.
3. Repeat the same process to install **P2** Scoreboard onto **P4** Left Cabinet Door.

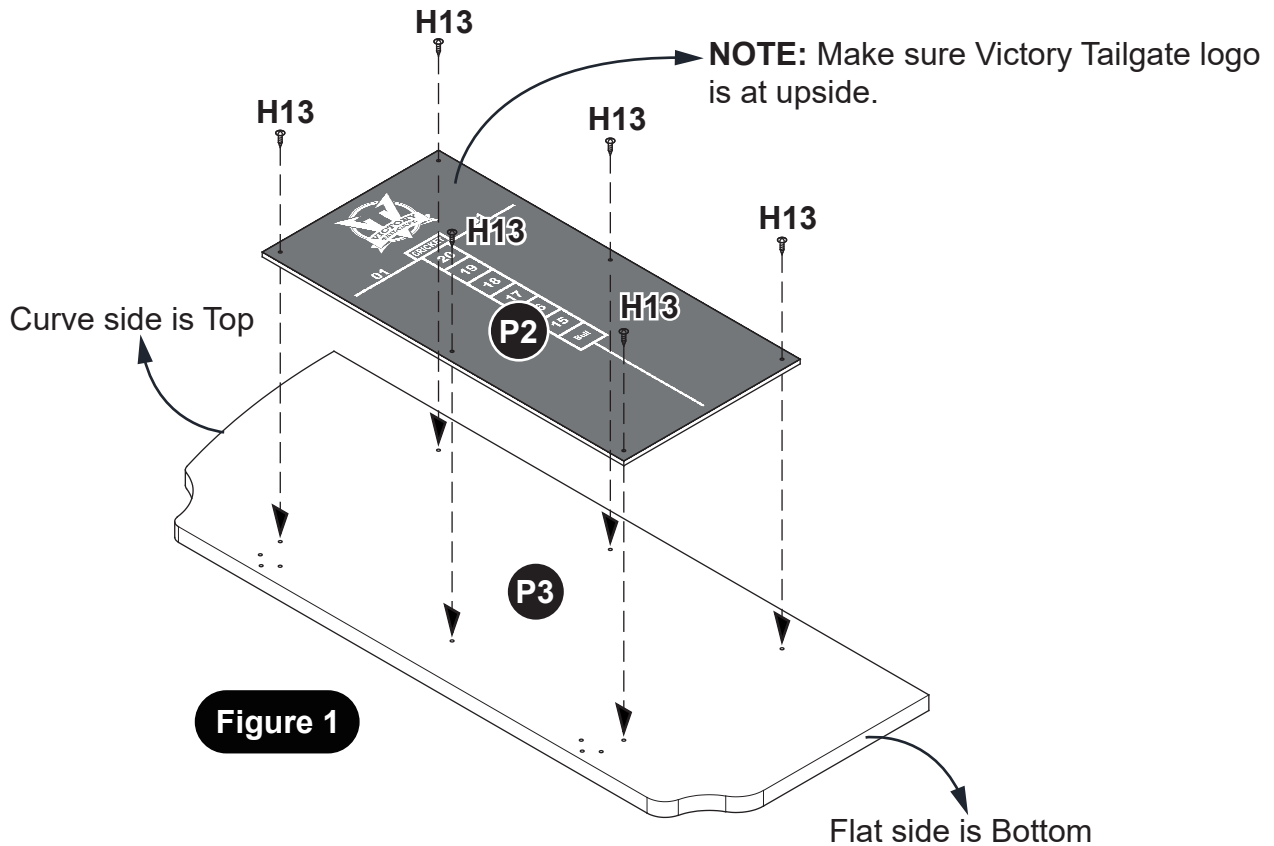

Step.2 Hinge onto Cabinet Door

1. Align 3 holes on each **H12** Hinge onto **P3** Right Cabinet Door's 6 pilot holes.
 2. Make sure to push the the Hinge to completely stick on Cabinet Door's edge.
 3. Using 2 pcs **H13** Rounded Head Screw & 1 pc **H14** Flat Head Screw to screw it to each Hinge.
- Point 1 to 3** in this step shown on **Figure 2**.
4. Repeat the same process to install **H12** Hinge to **P4** Left Cabinet Door.

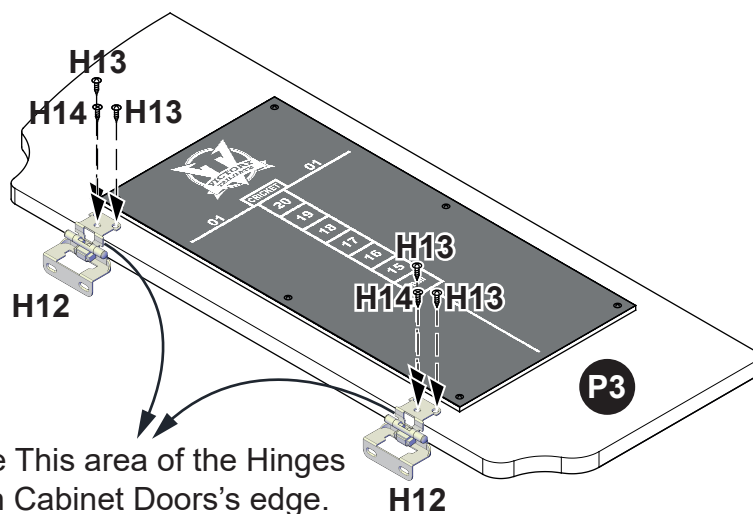

Step.3 Install Cabinet Door Assembled onto Cabinet Body

1. Firstly, please prepare some block such as wooden block with thickness **8.7cm (3-1/2")**. Recommended block minimum size is **45 x 30 (17-3/4" x 11-3/4")** for easier installation.
2. Put **Cabinet Door Assembled** from Step 2 onto this block, with the side installed with hinge must be flush with the block.
3. Align the the other fold side from the Hinge to the pilot holes on **P1** Cabinet Body frame inner side.
4. Using 2 pcs **H13** Rounded Head Screw screw it to each Hinge per shown on **Figure 3**.
5. Repeat above step to install Left Cabinet Door onto Cabinet Body.
6. Make sure the bottom edge of both doors are flush when the doors closed. If it not flush, you can adjust it with loosen **H13** screw on one of the doors, slightly slide the door up or down to get the better result.

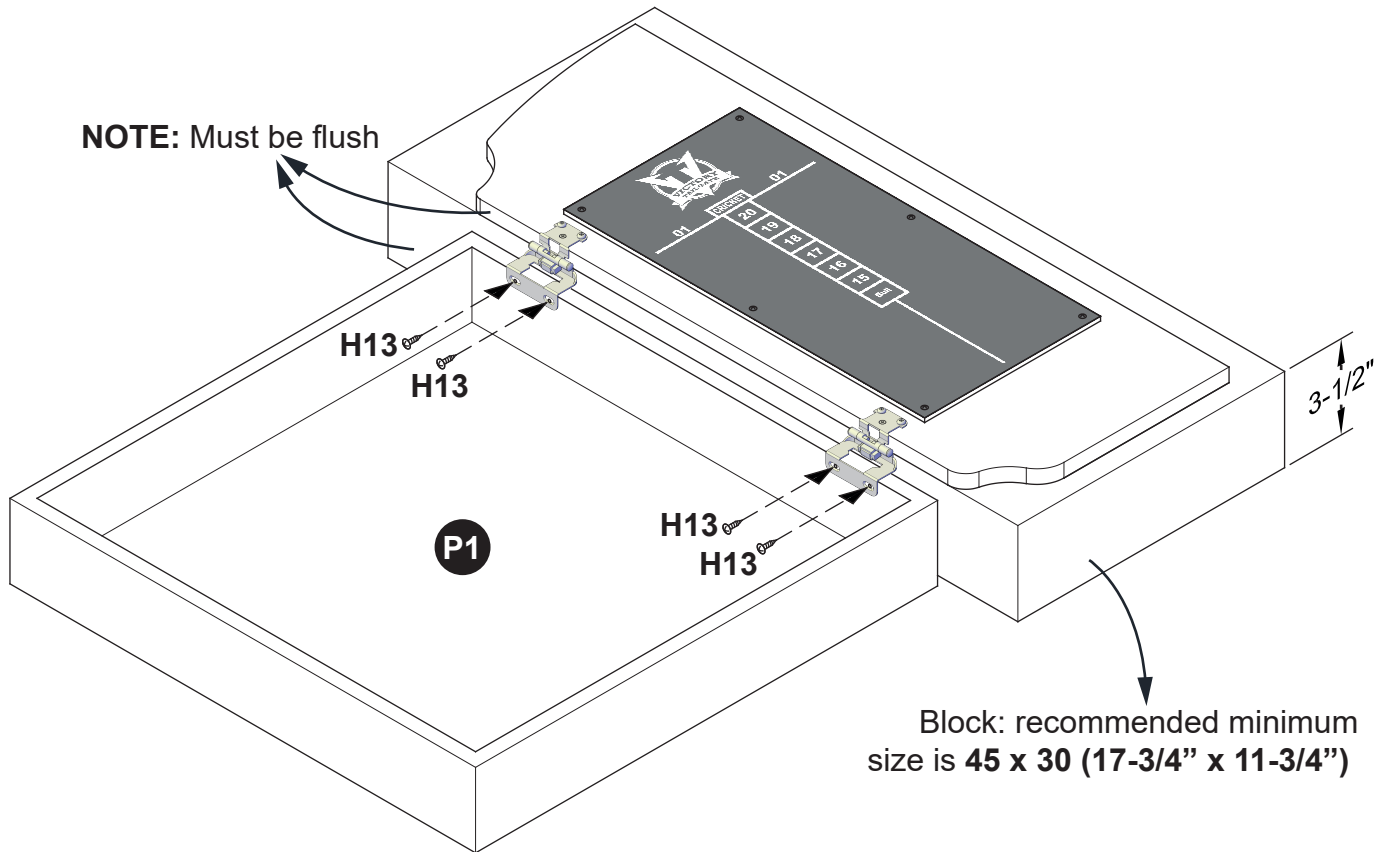

INSTALL THE DARTBOARD MOUNTING BRACKET INTO CABINET

Step.1 Install Mounting Bracket

1. Align 2 holes on the H1 Mounting Bracket with the 2 backboard center holes.
 2. Using 2 pcs H2 Screw and H3 Washer, insert from the cabinet backside and go through the 2 backboard center holes.
 3. Install 2 pcs H4 Nut onto 2 pcs H2 screws, tighten using plyers & phillips driver.
- Refer to **Figure 1** & **Figure 1.1**.

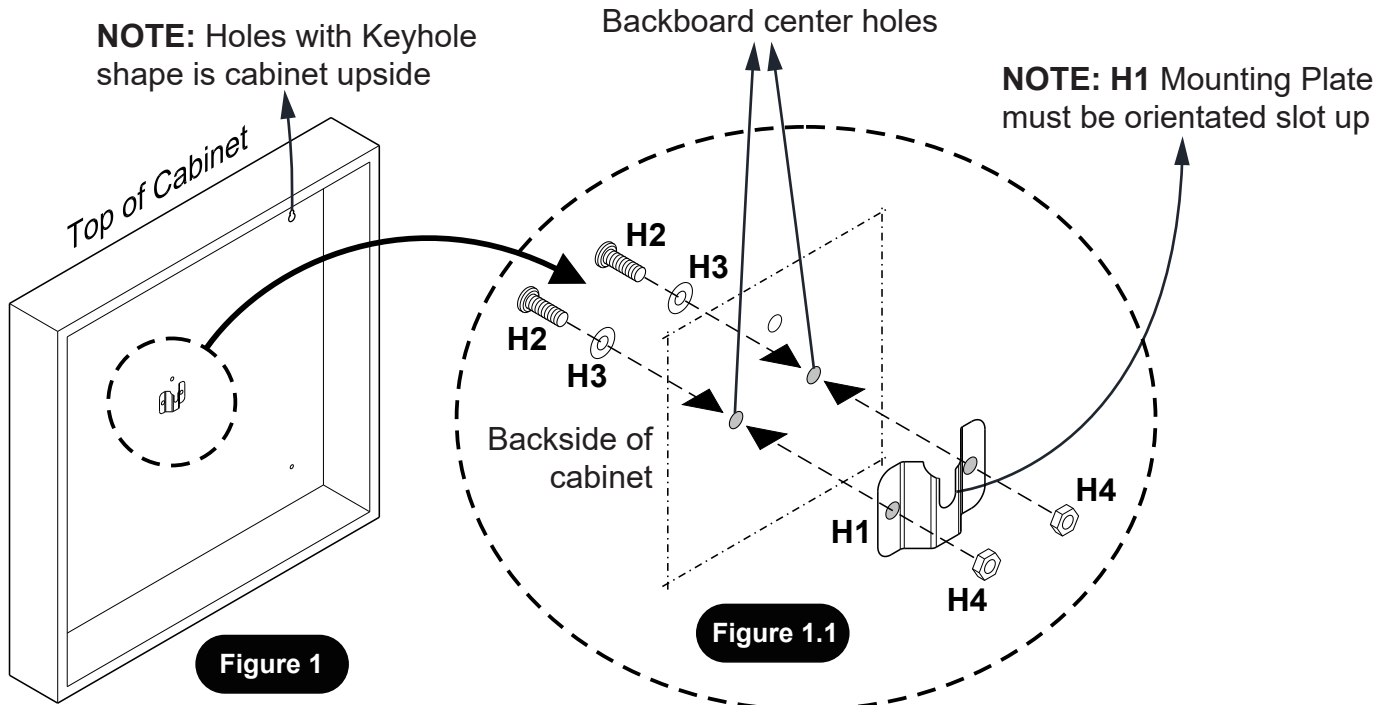

***NOTE:** Cabinet doors not shown for clarity.

Step.2 Mount Dartboard Cabinet onto Wall

Important Safety Information:

Install and use this dartboard cabinet with care. Please read the entire manual and all instructions before attempting installation and carefully follow all instructions contained herein. Use proper safety equipment during installation which includes ANSI-Approved safety glasses and heavy duty work gloves.

Note: FAILURE TO READ AND FOLLOW THESE INSTRUCTIONS WILL VOID THE WARRANTY.

Please call a qualified installation contractor for help if you:

- A. Don't understand the instructions in this manual or have any doubts about the safety of this installation .
- B. You are uncertain about the nature of your wall .
- C. You decide to hang the dart cabinet in a manner that does not utilize the "WOOD STUD MOUNTING INSTRUCTIONS BELOW ".

Do not use this product for any purpose or in any configuration not explicitly specified in these instructions. Escalade Sports hereby disclaims any and all liability for injury or damage arising from incorrect assembly, incorrect mounting or any incorrect use of this product.

Note: The mounting hardware supplied with this product is **NOT** designed for installation to walls with steel or aluminum studs, cinder block walls, brick, stone, hollow walls, gypsum board, drywall and or similar materials. If the hardware for your installation is not included , please consult your local hardware store for the proper mounting hardware for this product as per your application.

Note: As a convenience to our Valued Customers , we have designed this Dart Cabinet Mounting Instruction to be able to be performed by one adult.



Tools required:

- Stud Finder
- Tape Measure .
- Small & Medium Phillips driver – Electric OK --- Low torque as to not strip out any screws .
- Carpenters Level
- Awl and or Pencil
- Drill and 1/16" Drill Bit
- Thin Nail
- Plyers

WOOD STUD MOUNTING WITH WOOD STUDS AT 16" ON CENTER:

Verify that the mounting surface has no hidden utility lines before drilling or driving screws.

DO NOT MOUNT THE CABINET TO, A HOLLOW WALL, GYPSUM BOARD, DRYWALL OR SIMILAR MATERIALS THAT WILL NOT SUPPORT THE WEIGHT OF THE DART BOARD CABINET AND BRISTLE BOARD.

The dart board cabinet must be mounted to two wood studs. Use a stud finder to locate two adjacent wood studs. It is a good idea to verify exactly where the studs are located with an awl or thin nail.

Note: "Stud Finders " are available at your local hardware store.

IMPORTANT NOTES:

The height of the cabinet, is decided by the correct height of the dart board's BULL'S EYE. This measurement is with the dartboard installed into the cabinet and is 5'8", or 68", or 1.7 m from the Bulls Eye to the floor.

Also, double check that the cabinets 4 mounting holes are 16" on center both horizontally and vertically (Just as a double check).

Make sure the holes you are about to drill are in the **center of the stud**, and **level** with each other. The drill bit **MUST** be smaller than the Cabinet Wall Mounting Screws.

At this point you have completed the following steps:

- Decided where you want to hang the Dartboard Cabinet.
- You have correctly located 2 adjacent 2" x 4 " wooden studs.
- You have determined the center of each of the 2" x 4" vertical studs.

- Next, locate the **H11** - 16" Template for Mounting Dart Cabinet packed with the product.
On the left and right stud, measure up from the floor 76" and using an awl or pencil, mark 76" at the center of each stud.
- Using the **H11** template, place the left circle on the template exactly correct over the 76" mark.
- Now, holding the template horizontal and flat to the wall, use the **H11** template and mark the right stud at the 76" mark .
- Please confirm the 2 measurements now marked on the wall.
 - The vertical measurements from the floor to the mark on each stud is 76".
 - The horizontal measurement is exactly 16" from the center of the left stud to the center of the right stud.
- Lastly, use a carpenters level and make sure the two 76" marks are exactly level with each other. Remark the 76" marks as required to achieve levelness while maintaining the 16" on center distance between the two.
- Using a 1/16" drill bit carefully drill a Pilot Hole straight into each of the 2 marked areas.
- Again, confirm exactly 16" on center between the two holes and each is 76" from the floor, and the holes are level with each other.
- Remove H11 template from the wall.**
- Peel and stick 2 pcs **H10** EVA Pad aligned with the 2 pilot holes onto the wall.
- Next, locate 2 pcs **H8** Screws, install through EVA pad holes into the pilot holes as per **Figure 2.1**.

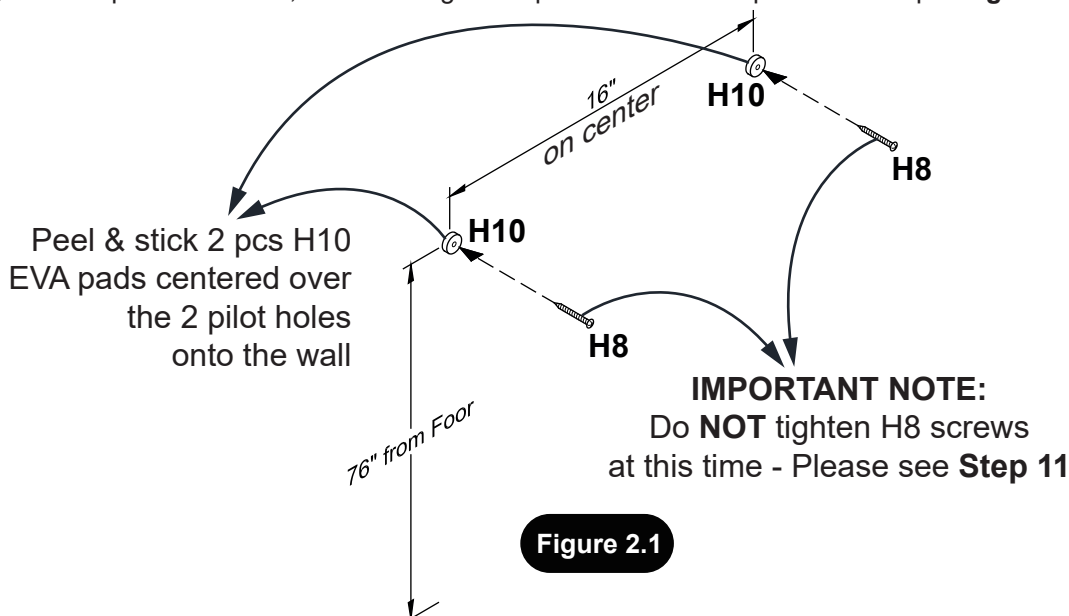

11. Now, install **H8** screws into each drilled pilot hole leaving approx. **1/2"** of the screw head exposed from the wall as per **Figure 2.2**. (This will allow you to "Hang" the Dart Cabinet onto these two screws).
12. Carefully hang the dart cabinet onto these two hanging screws. Make sure the cabinet gently drops down into the "keyhole slots" on the back of the cabinet. Snug Tighten screws. Snug only as these screws will be temporarily removed and reinstalled momentarily. Please see **Figure 2.3**.
13. Now, using the drill and 1/16" drill bit carefully drill pilot holes, using the bottom two holes in the back lower part of the cabinet as guides. Install 2 pcs **H8** Wall Mounting Screws with **H9** Washers and tighten, do not strip out the screws. See **Figure 2.3**.

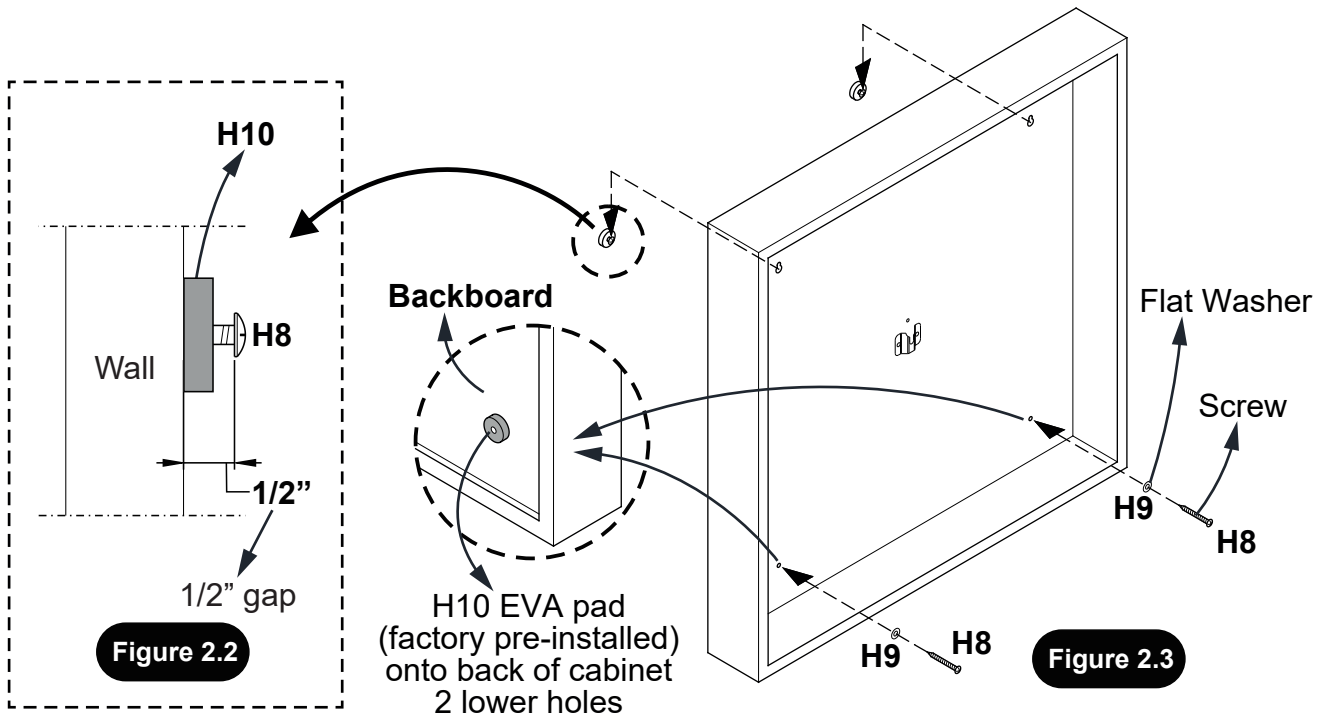

***NOTE: Cabinet doors not shown for clarity.**

15. Next, and **only one at a time**, remove the top **H8** screws, install a **H9** Flat Washer onto the screw, reinstall and tighten. Do not strip out the screws. See **Figure 2.4**.

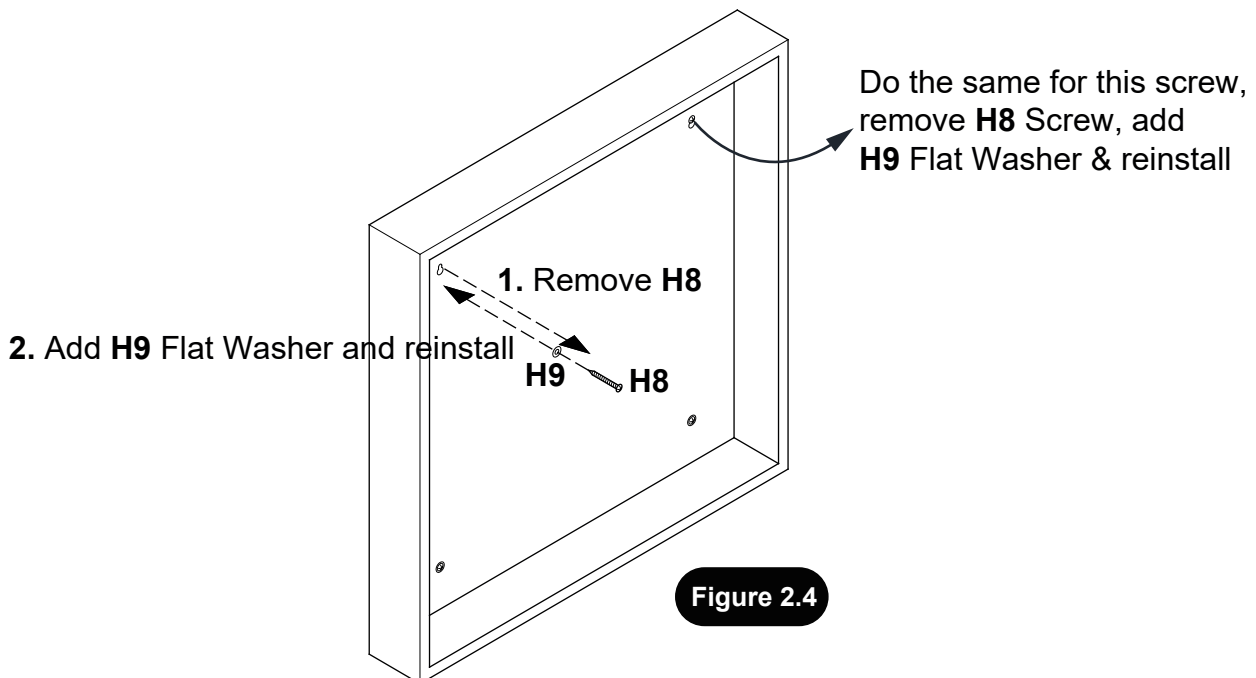

***NOTE: Cabinet doors not shown for clarity.**

Step.3 Install Dartboard into Cabinet

1. Install **H5** Mounting Screw to the pilot hole which is marked with black marker on the **back center** of the dartboard and leave approx. 1/8" of the screw head exposed from the backboard per shown on **Figure 3.1**. (This will allow you to "Hang" the dartboard onto mounting bracket which was installed in Step 1).
2. Install 3 pcs **H7** Bumper to 3 pilot holes onto the back of the dartboard using 3 pcs **H6** Bumper Screw and tighten, do not strip out screws. Please see **Figure 3.2**.

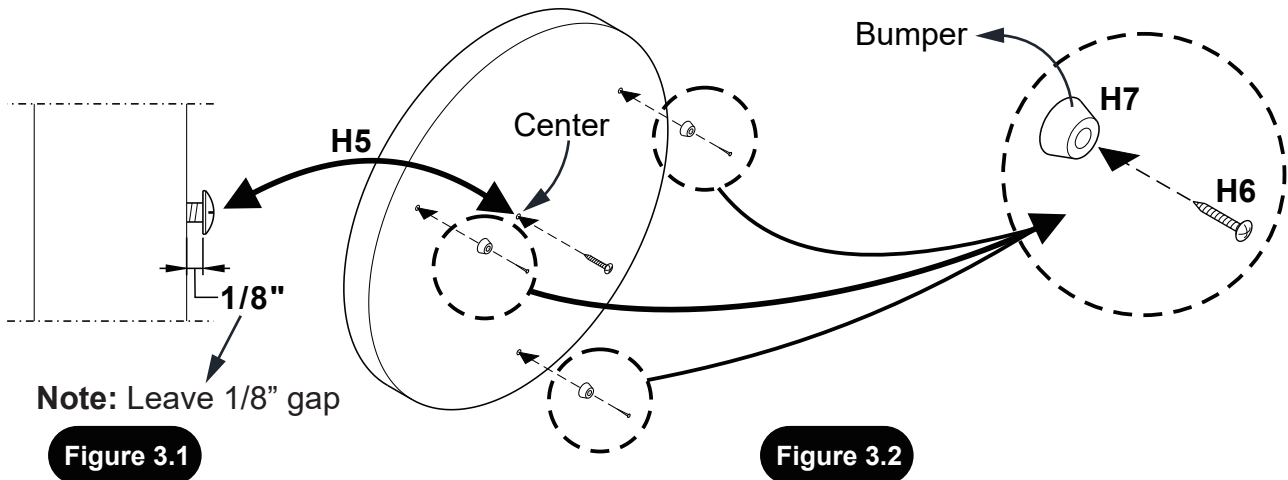

3. Hang the dartboard onto the cabinet by hanging the dartboard center screw onto the **H1** Mounting Bracket slot.
Note: While Figure 3.1 shows a 1/8" gap in order to hang the dartboard onto the hanger, a small amount of "adjusting" may be required on the H5 center screw in order to achieve the best fit for the dartboard onto the cabinet.
4. Rotate and adjust Number "20" at the top.
Please see **Figure 3.3**.

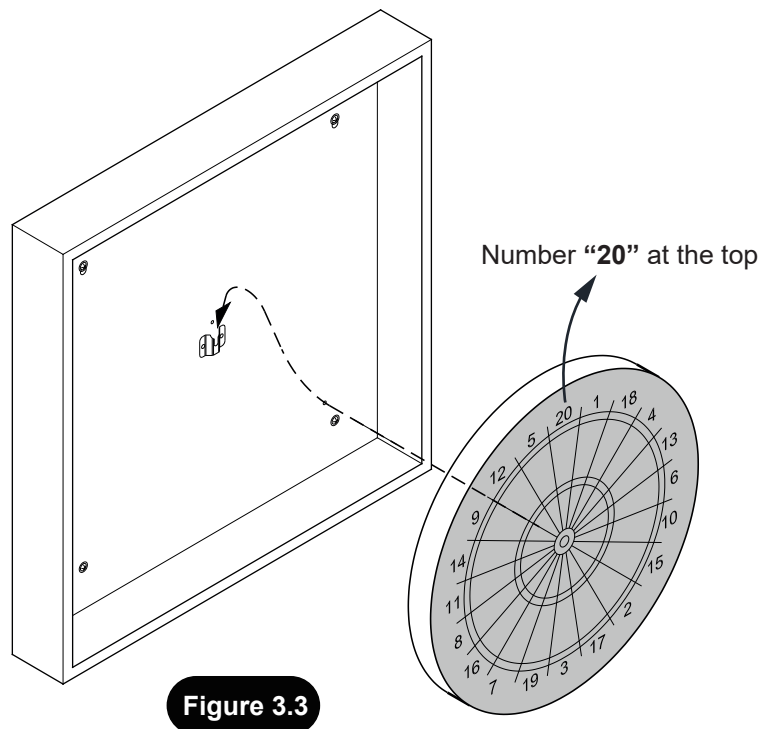

***NOTE: Cabinet doors not shown for clarity.**

Darting Game Rules

Various darting websites are available that explain darting rules and other specifics of the game.