

Product Type

POW-SunSmart 8K

POW-SunSmart 10K

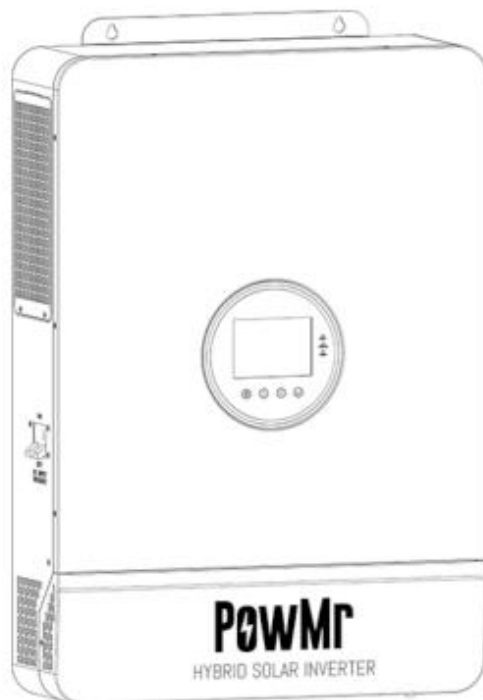

POWMr

HYBRID INVERTER

User Manual

Important Safety Instructions

Please save these instructions for future use!



Read all of the instructions and cautions in the manual before beginning the installation !

■ Important Safety Instructions

- Installation and wiring must comply with the Local and National Electric Codes (NEC) and must be done by a certified technician.
- Do NOT disassemble or attempt to repair the inverter. There are no serviceable parts for this inverter.
- DO NOT parallel this device with other AC input sources to avoid damage.
- DO NOT attempt to touch the unit while it is operating as temperatures will be very hot. In addition, do not open the terminal cover while the unit is in operation.
- Make sure all connections going into and from the inverter are tight. There may be sparks when making connections, therefore, make sure there are not flammable materials or gases near installation.
- Installing breakers or fuses outside of the unit is recommended.
- After installation, check that all line connections are tight and secured.
- Do NOT let the positive (+) and negative (-) terminals of the battery touch each other. Use Lithium batteries or deep cycle Sealed Lead Acid, Flooded, Gel, AGM batteries.
- Explosive battery gases may be present while charging. Be certain there is enough ventilation to release the gases.
- Be careful when working with large lead acid batteries. Wear eye protection and have fresh water available in case there is contact with the battery acid.
- Over-charging and excessive gas precipitation may damage the battery plates and activate material shedding on them. Too high of an equalizing charge or too long of one may cause damage. Please carefully review the specific requirements of the battery used in the system.

Table of Contents

| | |
|---|-----------|
| Important Safety Instructions | 1 |
| Safety | 4 |
| How to use this manual | 4 |
| Symbols in this manual..... | 4 |
| Safety instructions..... | 4 |
| Production Instructions | 5 |
| Instructions | 5 |
| Features | 5 |
| System connection diagram..... | 6 |
| Production Overview | 7 |
| Installation | 8 |
| Select the mount location | 8 |
| Mount the inverter | 9 |
| Remove the terminal cover and insect screen | 9 |
| Connection | 10 |
| Connection Overview..... | 10 |
| Cable & circuit breaker requirement | 13 |
| AC input & output connection..... | 15 |
| Battery Connection..... | 15 |
| PV connection..... | 16 |
| Dry contact connection | 17 |
| Grounding connection | 17 |
| Final assembly | 17 |
| Start up the inverter..... | 17 |
| Operation | 18 |
| Operation and display panel | 18 |
| Setting | 23 |
| AC output mode | 30 |
| Battery charging mode..... | 31 |
| Time-slot charging/discharging function | 32 |

| | |
|--|-----------|
| Battery parameter | 34 |
| Communication..... | 36 |
| Overview..... | 36 |
| USB-B port | 36 |
| RS485-1port | 37 |
| CAN/RS485-2port | 37 |
| Dry contact | 38 |
| Fault and Remedy | 39 |
| Faultcode..... | 39 |
| Trouble shooting | 41 |
| Protection and Maintenance..... | 43 |
| Protection features | 43 |
| Maintenance | 44 |
| Datasheet..... | 45 |

Safety

■ How to use this manual

- This manual contains important information, guidelines, operation and maintenance for the following products: POW-SunSmart 10K and POW-SunSmart 8K
- The manual must be followed during installation and maintenance.

■ Symbols in this manual

| Symbol | Description |
|-----------------------|---|
| <i>DANGER</i> | DANGER indicates a hazardous situations which if not avoided will result in death or serious injury. |
| <i>WARNING</i> | WARNING indicates a hazardous situations which if not avoided could result in death or serious injury. |
| <i>CAUTION</i> | CAUTION indicates a hazardous situations which if not avoided could result in minor or moderate injury. |
| <i>NOTICE</i> | NOTICE provide some tips on operation of products. |

■ Safety instructions

DANGER

- This chapter contains important safety instructions. Read and keep this manual for future reference.
- Be sure to comply the local requirements and regulation to install this inverter.
- Beware of high voltage. Please turn off the switch of each power sources before and during the installation to avoid electric shock.
- For optimum operation of this inverter, please follow required specification to select appropriate cable size and necessary protective device.
- Do not connect or disconnect any connections when the inverter is working.
- Do not open the terminal cover when the inverter working.
- Make sure the inverter is well grounding.
- Never cause AC output and DC input short circuited.
- Do not disassembly this unit, for all repair and maintenance, please take it to the professional service center.
- Never charge a frozen battery.
- Please keep children away from touching or mishandling the inverter.
- Please make sure that this inverter is the only input power source for the load, do not use it in parallel with other input AC power sources to avoid damage.

Production Instructions

■ Instructions

POW-SunSmart series is a new type of solar energy storage inverter control inverter integrating solar energy storage & utility charging and energy storage, AC sine wave output. It adopts DSP control and features high response speed, reliability, and industrial standard through an advanced control algorithm.

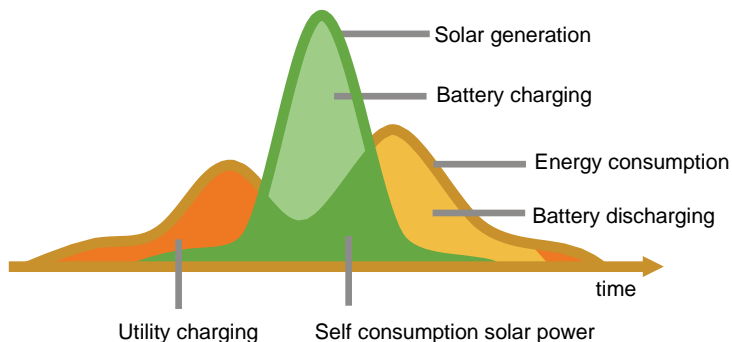

■ Features

- Supports lead acid battery and li-ion battery connections.
- With a dual activation function when the li-ion battery is dormant; either mains/photovoltaic power supply access can trigger the activation of the li-ion battery.
- Support split-phase and single-phase pure sine wave output.
- Supports four different voltage levels of 100Vac, 105Vac, 110Vac, and 120Vac per phase.
- Supports two solar inputs and simultaneous tracking of two solar maximum power charging/carrying capacity functions.
- Dual MPPT with 99.9% efficiency and maximum 22A current in a single circuit, perfectly adapted to high power modules.
- 4 charging modes are available: solar only, mains priority, solar priority, and mixed mains/PV charging.
- With the time-slot charging and discharging setting function, you can set the time period for cutting in/out of mains charging and switch the time period between battery discharging and mains bypass power supply mode.
- Energy saving mode function to reduce no-load energy losses.
- With two output modes of utility bypass and inverter output, with uninterrupted power supply function.
- LCD large screen dynamic flow diagram design, easy to understand the system data and operation status.
- 360° protection with complete short circuit protection, over current protection, over under voltage protection, overload protection, backfill protection, etc.
- Support CAN, USB, and RS485 communication.

■ System connection diagram

The diagram below shows the system application scenario of this product. A complete system consists of the following components:

- 1. PV modules:** converts light energy into DC energy, which can be used to charge the battery via an inverter or directly inverted into AC power to supply the load.
- 2. Utility grid or generator:** connected to the AC input, it can supply the load and charge the battery at the same time. The system can also operate generally without the mains or generator when the battery and the PV module power the load.
- 3. Battery:** The role of the battery is to ensure the regular power supply of the system load when the solar energy is insufficient and there is no mains power.
- 4. Home load:** Various household and office loads can be connected, including refrigerators, lamps, televisions, fans, air conditioners, and other AC loads.
- 5. Inverter:** The energy conversion device of the whole system.

The actual application scenario determines the specific system wiring method.

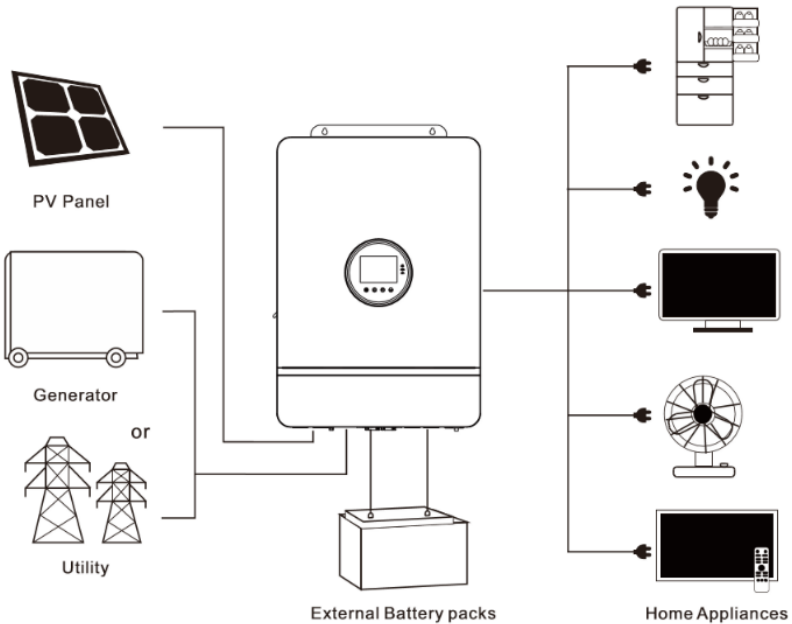

■ Production Overview

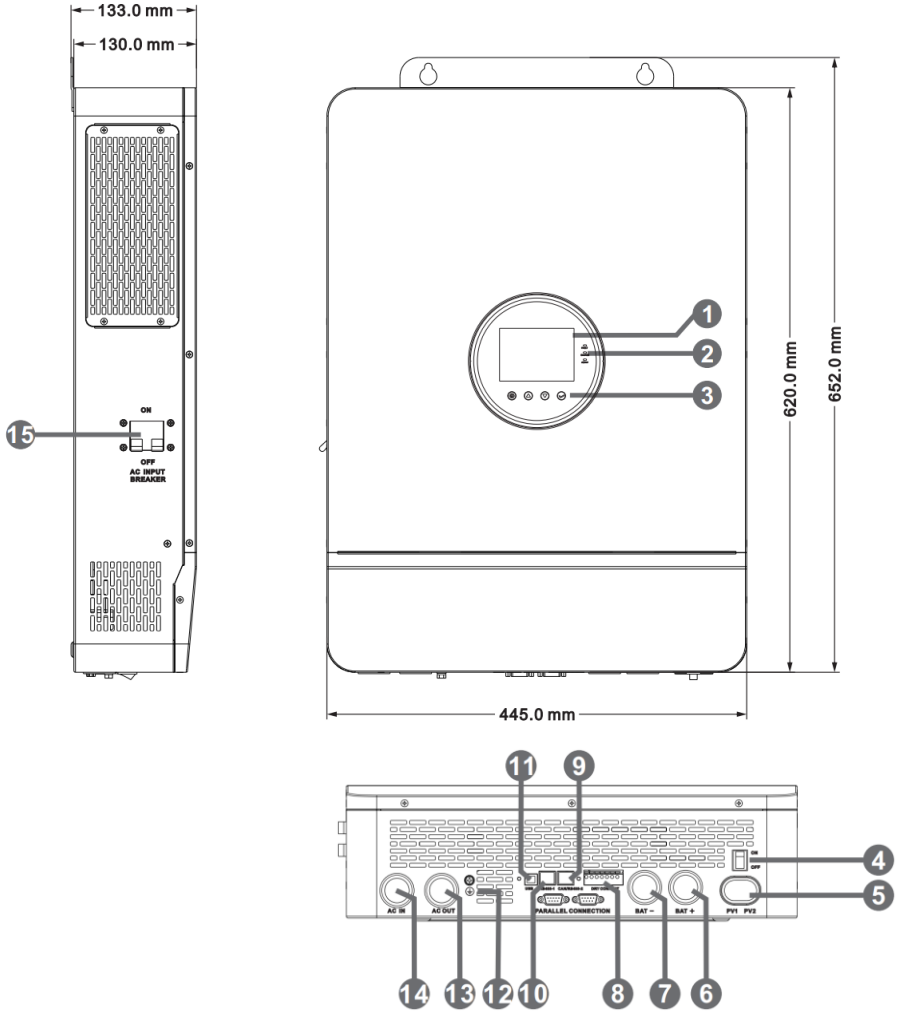

| | | | | | |
|----|----------------------|----|----------------|----|------------------|
| 1 | LCD screen | 2 | LED Indicators | 3 | Touchable key |
| 4 | ON/OFF Rocker Switch | 5 | PV INPUT (1/1) | 6 | BAT INPUT (+) |
| 7 | BAT INPUT (-) | 8 | Dry contact | 9 | CAN/RS485-2 port |
| 10 | RS485-1 port | 11 | USB-B port | 12 | Grounding Screw |
| 13 | AC OUT (L+L+N) | 14 | AC IN (L+L+N) | 15 | AC INPUT breaker |

Installation

■ Select the mount location

POW-SunSmart series are designed for **INDOOR USE ONLY** (IP20) . Please consider the followings before selecting the location.

- Choose the solid wall to install the inverter.
- Mount the inverter at eye level.
- Adequate heat dissipation space must be provided for the inverter.
- The ambient temperature should be between $-10\sim 55^{\circ}\text{C}$ ($14\sim 131^{\circ}\text{F}$) to ensure optimal operation.

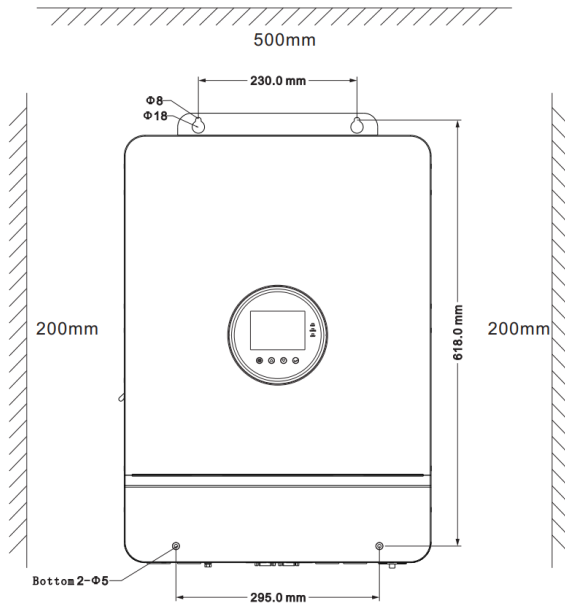

DANGER

- Do not install the inverter where highly flammable materials are near by.
- Do not install the inverter in potential explosive areas.
- Do not install the inverter with lead-acid batteries in a confined space.

CAUTION

- Do not install the inverter in direct sunlight.
- Do not install or use the inverter in a humid environment.

■ Mount the inverter

Make 4 mounting holes in the wall with an electric drill according to the specified dimensions, insert 2 expansion screws above and fix the inverter with 2 M5 screws below.

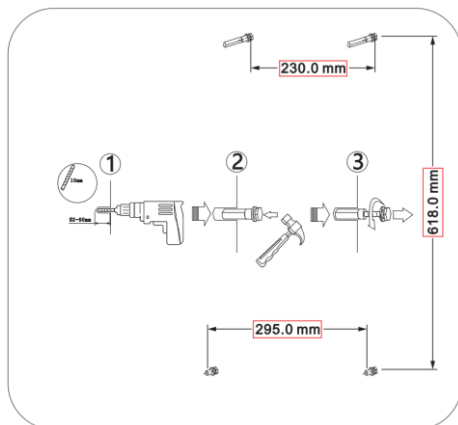

■ Remove the terminal cover and insect screen

Using a screwdriver, remove the terminal protection cover and insect screen.

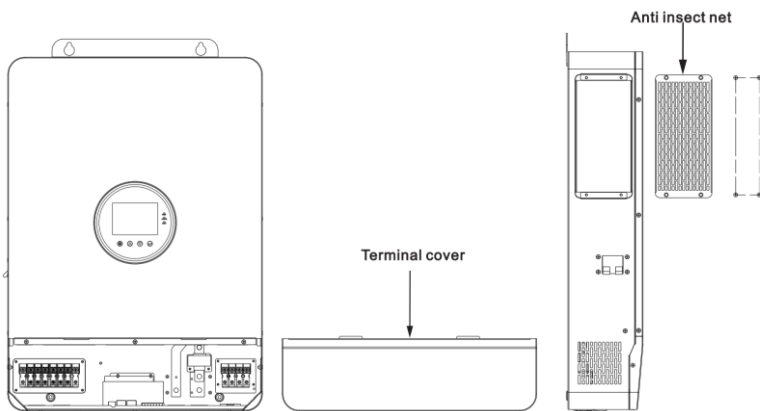

NOTICE

When using the device in areas with poor air quality, the dust screen is easily blocked by airborne particles. Please dismantle and clean the dust screen regularly to avoid affecting the internal air flow rate of the inverter, which may trigger an over-temperature protection fault (19/20 fault) affecting the use of the power supply and the service life of the inverter.

Connection

■ Connection Overview

● Split-phase mode (default)

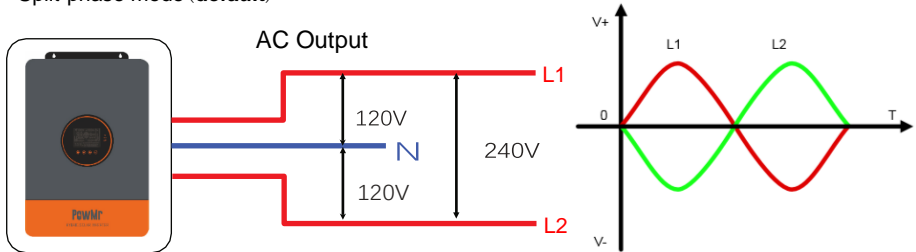

| Items | Description |
|----------------------------|-----------------------------|
| Applicable Model | POW-SunSmart series U model |
| Output Voltage Range (L-N) | 100~120Vac, 120Vac default |
| Output Voltage Range (L-L) | 200~240Vac, 240Vac default |

● Single-phasemode

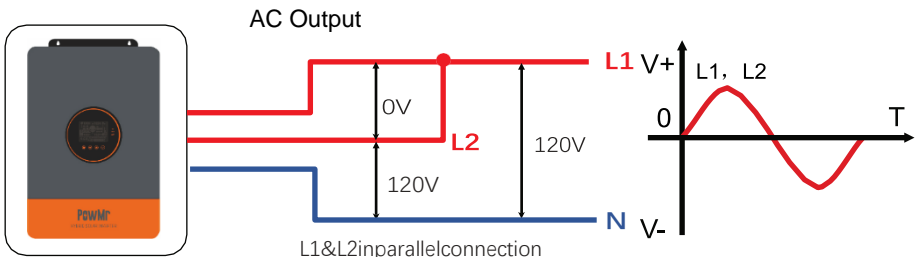

| Items | Description |
|----------------------------|-----------------------------|
| Description | POW-SunSmart series U model |
| Output Voltage Range (L-N) | 100~120Vac, 120Vac default |

NOTICE

- Users can change the output phase mode and output voltage by setup menu. Please read the chapter 5.2 Setting.
- Output phase mode corresponds parameter 39 , when option is 180 indicates split-phase, when option is 0 indicates single-phase.
- Output voltage corresponds parameter 38 , the output voltage can be set from 100V to 120V.

Split-phase Mode

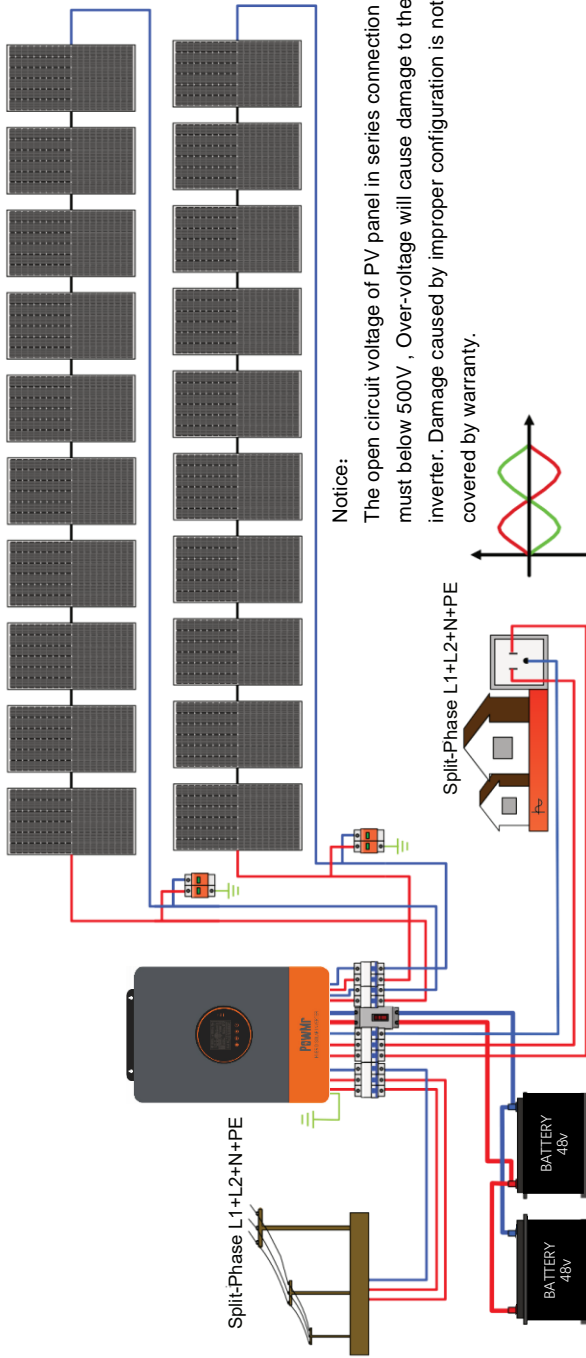

Single-phase Mode

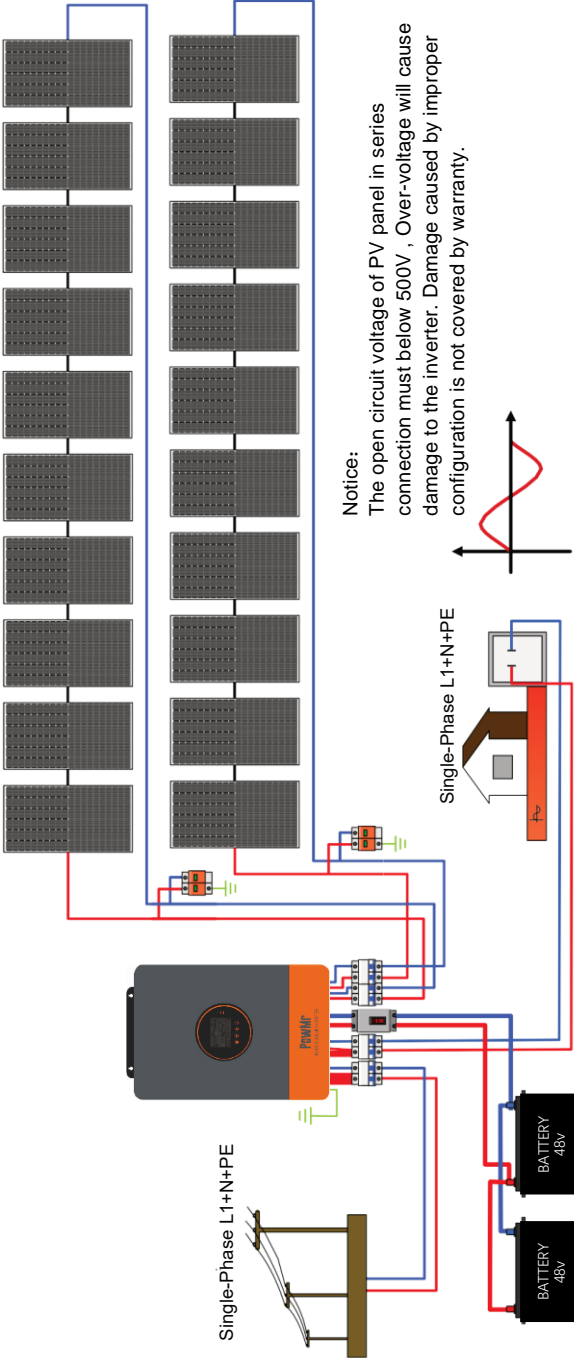



■ Cable & circuit breaker requirement

● PV INPUT

| Model | Cable Diameter | Max.PV Input Current | Circuit Breaker Spec |
|------------------|---------------------------|----------------------|----------------------|
| POW-SunSmart 8K | 5mm ² / 10 AWG | 22A | 2P-25A |
| POW-SunSmart 10K | 5mm ² / 10 AWG | 22A | 2P-25A |

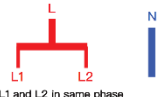

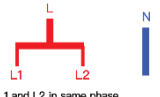
● AC INPUT

| Model | Output Mode | Diagram | Max.Input Current | Cable diameter | Circuit Breaker Spec |
|------------------|--------------|--|-----------------------|--|----------------------|
| POW-SunSmart 8K | Split-phase |  | 63A(L1/L2/N) | 13mm ² /6AWG (L1\L2\N) | 3P-63A |
| | Single-phase |  | 63A(L1/L2) 126A(N) | 13mm ² /6AWG(L1/L2) 26mm ² /3AWG(N) | 2P-125A |
| POW-SunSmart 10K | Split-phase |  | 63A(L1/L2/N) | 13mm ² /6AWG (L1\L2\N) | 3P-63A |
| | Single-phase |  | 63A(L1/L2) 126A(N) | 13mm ² /6AWG(L1/L2) 26mm ² /3AWG(N) | 2P-125A |

● BATTERY

| Model | Cable Diameter | Max.Battery Current | Circuit Breaker Spec |
|------------------|---------------------------|---------------------|----------------------|
| POW-SunSmart 8K | 34mm ² / 2 AWG | 180A | 2P-200A |
| POW-SunSmart 10K | 42mm ² / 1 AWG | 220A | 2P-250A |

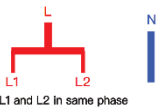
● AC OUTPUT

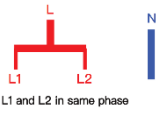
| Model | Output Mode | Diagram | Max. Output Current | Cable diameter | Circuit Breaker Spec |
|------------------|--------------|---|------------------------|--|----------------------|
| POW-SunSmart 8K | Split-phase |  | 42A (L1/L2/N) | 13mm ² /6AWG (L1/L2/N) | 3P-63A |
| | Single-phase |  | 42A (L1/L2) 84A(N) | 13mm ² /6AWG(L1/L2) 26mm ² /3AWG(N) | 2P-125A |
| POW-SunSmart 10K | Split-phase |  | 63A (L1/L2/N) | 13mm ² /6AWG (L1/L2/N) | 3P-63A |
| | Single-phase |  | 63A (L1/L2) 126A(N) | 13mm ² /6AWG(L1/L2) 26mm ² /3AWG(N) | 2P-125A |

NOTICE

● PV INPUT, AC INPUT, AC OUTPUT

1. Use a stripper to remove the 6~8mm insulation of the cable.
2. Fixing a ferrule at the end of the cable. (ferrule needs to be prepared by the user)

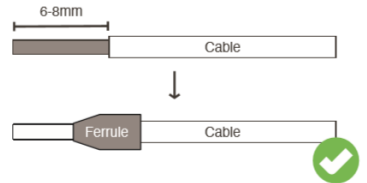

● BATTERY

1. Use a stripper to remove the 6~8mm insulation of the cable
2. Fixing cable lugs that supply with the box at the end of the cable.

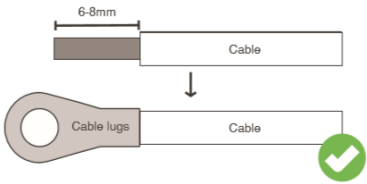

The wire diameter is for reference only. If the distance between the PV array and the inverter or between the inverter and the battery is long, using a thicker wire will reduce the voltage drop and improve the performance of the system.

■ AC input & output connection

Connect the live, neutral and ground wires according to the cables' position and order shown in the diagram below.

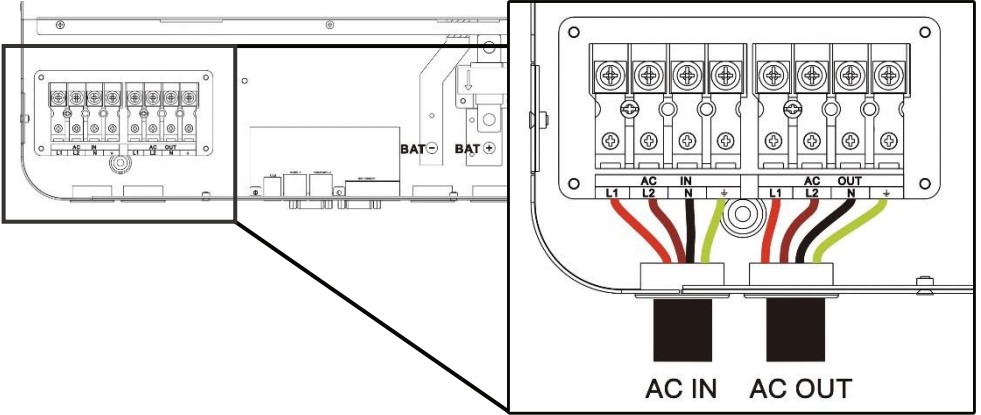

DANGER

- Before connecting AC inputs and outputs, the circuit breaker must be opened to avoid the risk of electric shock and must not be operated with electricity.
- Please check that the cable used is sufficient for the requirements, too thin, poor quality cables are a serious safety hazard.

■ Battery Connection

Connect the positive and negative cable of the battery according to the diagram below.

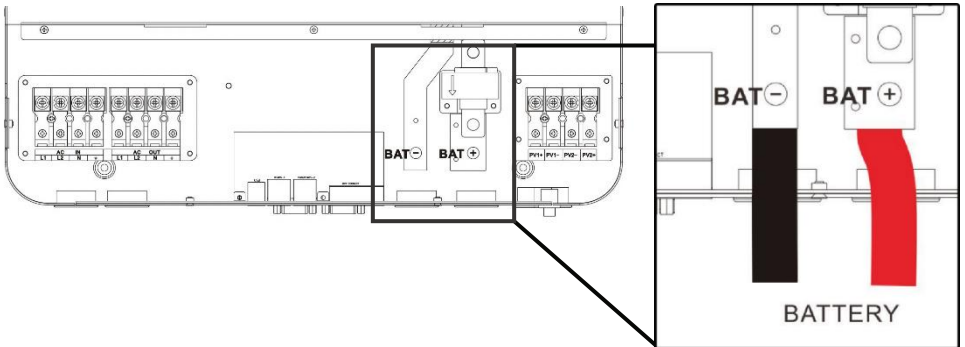

DANGER

- Before connecting battery, the circuit breaker must be opened to avoid the risk of electric shock and must not be operated with electricity.
- Make sure that the positive and negative terminals of the battery are connected correctly and not reversed, otherwise the inverter may be damaged.
- Please check that the cable used is sufficient for the requirements, too thin, poor quality cables are a serious safety hazard.

■ PV connection

Connect the positive and negative wires of the two strings of PV according to the diagram below.

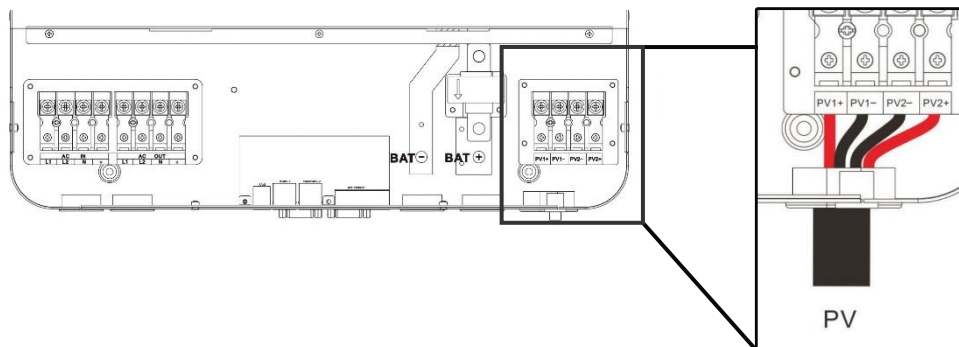

DANGER

- Before connecting PV, the circuit breaker must be opened to avoid the risk of electric shock and must not be operated with electricity.
- Please make sure that the open circuit voltage of the PV modules in series does not exceed the Max. Open Circuit Voltage of the inverter (In the POW-SunSmart series, this value is 500V), otherwise the inverter may be damaged.

■ Dry contact connection

Use a small screwdriver to push back the direction indicated by the arrow, then insert the communication cable into the dry junction port. (Communication cable diameter 0.2~1.5mm²)

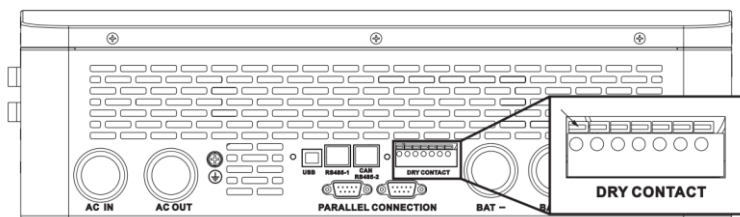

■ Grounding connection

Please make sure the grounding terminal connect to the Grounding Bar.

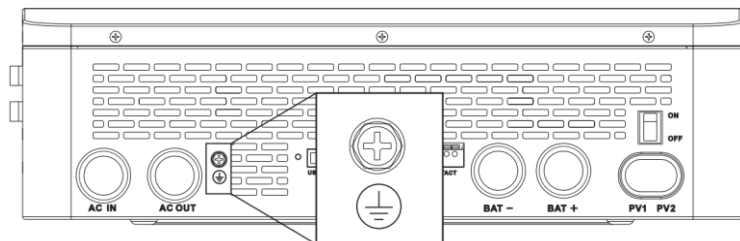

NOTICE

- The grounding cable should have a diameter of not less than 4 mm² and be as close as possible to the grounding point.

■ Final assembly

After ensuring that the wiring is reliable and the wire sequence is correct, install the terminal protection cover in place.

■ Start up the inverter

- Step 1: Close the circuit breaker of the battery.
- Step 2: Press the rocker switch on the bottom of inverter, the screen and indicators light up to indicate that the inverter has been activated.
- Step 3: Sequential close of the circuit breakers for PV, AC input and AC output.
- Step 4: Start the loads one by one in order of power from small to large.



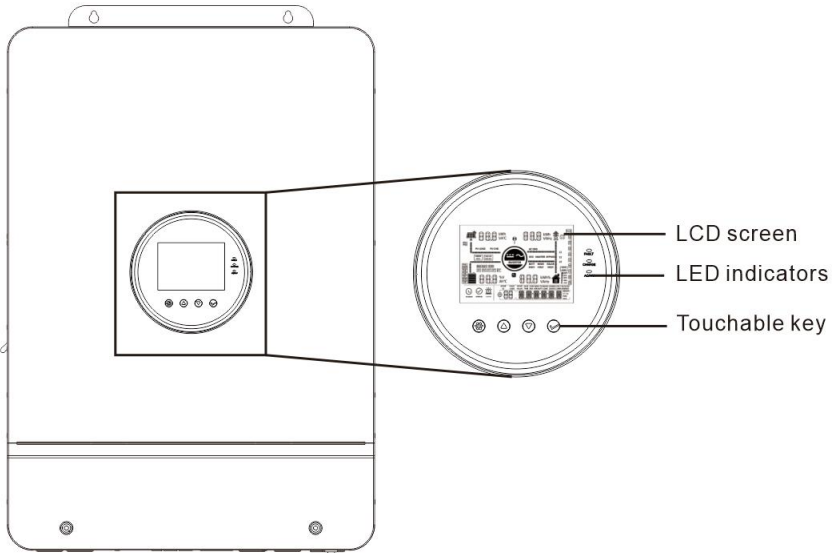

Operation

■ Operation and display panel

The operation and display panel below includes 1 LCD screen, 3 indicators, 4 touchable keys.



● Touchable Keys

| Touchable Keys | Description |
|---|--|
|  | To enter/exit the setting menu |
|  | To next selection |
|  | To last selection |
|  | To confirm/enter the selection in setting menu |







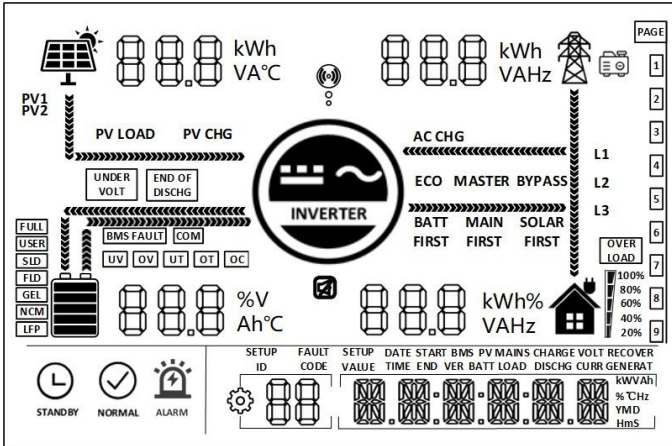

● LED Indicators

| Indicators | Color | Description |
|------------|--------|--|
| AC/INV | Yellow | Continued: utility grid by-pass output |
| | | Flash: inverter output |
| CHARGE | Green | Continued: charging complete |
| | | Flash: charging |
| FAULT | Red | Flash: error occur |

● Display panel



| Icon | Description | Icon | Description |
|-------------|---|------------|--|
| | Indicates the PV panel | | Indicates the utility grid |
| | Indicates the battery | | Indicates the generator |
| | Indicates the inverter is working | | Indicates the home load |
| | Indicates the inverter is communicating with data collector | | Indicates the buzzer muted |
| | Indicates the direction of energy flow | | |
| STANDBY | Indicates the inverter is standby | NORMAL | Indicates the inverter is working normally |
| ALARM | Indicates error occur | | Indicates setting |
| | Indicates load power 80%~100% | | Indicates battery SOC 80%~100% |

| | | | |
|---|--|---|---|
|  | Indicates load power 60%~79% |  | Indicates battery SOC 60%~79% |
|  | Indicates load power 40%~59% |  | Indicates battery SOC 40%~59% |
|  | Indicates load power 20%~39% |  | Indicates battery SOC 20%~39% |
|  | Indicates load power 5%~19% |  | Indicates battery SOC 5%~19% |
| UNDER VOLT | Indicates battery under-voltage | END OF DISCHG | Indicates battery discharge |
| OVER LOAD | Indicates over-load | BMS FAULT | Indicates BMS fault |
| COM | Indicates system communication error | UV | Indicates system under-voltage |
| OV | Indicates system over-voltage | UT | Indicates system under-temperature |
| OT | Indicates system over-temperature | OC | Indicates system over-current |
| FULL | Indicates battery is full | USER | Indicates user defined battery |
| SLD | Indicates sealed lead-acid battery | FLD | Indicates flooded lead-acid battery |
| GEL | Indicates gel lead-acid battery | NCM | Indicates ternary li-ion battery |
| LFP | Indicates LFP li-ion battery | ECO | Indicates energy-saving mode |
| PV LOAD | Indicates PV energy is carrying the load | PV CHG | Indicates PV energy is charging the battery |

| | | | |
|-------------------|---|--------------------|---|
| AC CHG | Indicates AC IN energy is charging the battery | MAIN FIRST | Indicates the inverter output mode is mains power first |
| BYPASS | Indicates the inverter output mode is bypass | SOLAR FIRST | Indicates the inverter output mode is solar first |
| BATT FIRST | Indicates the inverter output mode is battery first | | |

- View real-time data

In the main screen, press the UP / DOWN keys to view the real-time data of the inverter during operation.

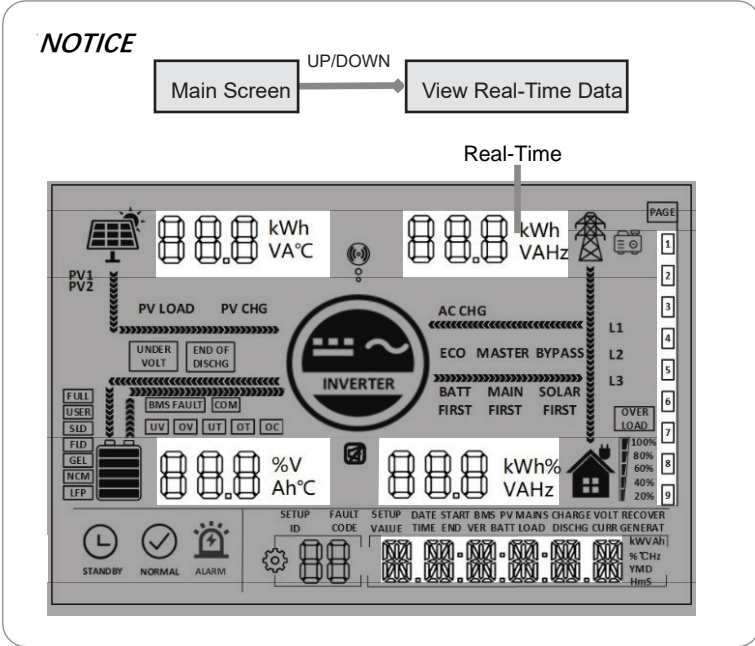

| Page | PV side | BAT side | AC IN side | LOAD side | General |
|------|-------------------------------|----------------------------|--------------------------|--------------------------------|------------------|
| 1 | PV voltage | Batt Voltage | AC in voltage | Single phase voltage | Current Time |
| 2 | PV current | Batt Current | AC in current | Single phase Current | Current Date |
| 3 | PV power | Batt Voltage | Total AC charging power | Single phase active power | PV Total kWh |
| 4 | PV today kWh | Batt Current | Today AC charging kWh | Single phase apparent power | Load Total kWh |
| 5 | PV side heat sink temperature | INV Heat Sink Temperature | AC frequency | AC output frequency | RS485 Address |
| 6 | PV rated voltage | Batt Rated Voltage | Busbar voltage | AC output rated power | Software Version |
| 7 | Max. PV charging current | Max. Batt charging current | Max. AC charging Current | Total AC output active power | / |
| 8 | | | / | Total AC output apparent power | / |

| | | | |
|----|--|---------------------|---|
| 02 | AC output frequency | 50.0 | AC output frequency will adaptive utility frequency in bypass mode. Otherwise the output will follow the preset value. |
| | | 60.0 <i>default</i> | |
| 03 | AC input voltage range | LPS <i>default</i> | When output range is 120/110V, input voltage range 90~140V |
| | | APL | When output range is 100/105V, input voltage range 85~140V |
| 04 | Voltage point of battery switch to utility | 43.6 | When parameter $\theta = 56U/50L$, output source will switch to utility from battery when the battery voltage below the preset value. Setting range:40~60V |
| 05 | Voltage point of utility switch to battery | 56.8 | When parameter $\theta = 56U/50L$, output source will switch to battery from utility when the battery voltage above the preset value. Range:40~60V |
| 06 | Battery charging mode | SNU <i>default</i> | Solar and utility charging the battery at the same time, solar at the first priority, utility power as a supplement when solar power is not sufficient. Notice: Solar and utility charging the battery at the same time only in bypass mode, only solar charging can be used when the invert circuit is in operation. |
| | | UUb | Utility is the first priority in charging, Solar charging the battery only when utility is not available. |
| | | USU | Solar is the first priority in charging, Utility charging the battery only when solar is not available. |
| | | USU | Only solar charging the battery. |
| 07 | Battery charging current | 60 | POW-SunSmart 8K current setting range:0~180A |
| | | | POW-SunSmart 10K current setting range:0~200A. |
| 08 | Battery type | USER | User-defined, user can set all battery parameter. |
| | | SLd | Sealed lead-acid battery. |
| | | FLd | Flooded lead-acid battery. |
| | | GEL <i>default</i> | Gel lead-acid battery. |

| | | | |
|----|--|-------------|---|
| | | L14/L15/L16 | LFP li-ion battery, 14\15\16 corresponds battery cells number in series. |
| | | M13/M14 | Ternary li-ion battery. |
| 09 | Battery bulk charging voltage | 57.6 | Setting range:48V~58.4V, increment of each click is 0.4V, parameter can be set only when battery type is USER and L14/15/16,M13/14 |
| 10 | Battery bulk charging delay time | 120 | Indicates the duration when battery voltage reached parameter value in bulk charging procession, Setting range: 5min~900min, increment of each click is 5min, parameter can be set only when battery type is USER and L14/15/16,M13/14 |
| 11 | Battery float charging voltage | 55.2 | Setting range: 48V~58.4V, parameters cannot be set only after successful BMS communication. |
| 12 | Battery over-discharge voltage (delay off) | 42 | When the battery voltage falls below this voltage point and parameter 1 value is reached, the inverter output will be switched off. Setting range: 40V~48V, increment of each click is 0.4V, parameter can be set only when battery type is USER and L14/15/16,M13/14 |
| 13 | Battery over-discharge delay time | 5 | Indicates the duration when battery voltage reached parameter 12 value in over-voltage procession. Setting range: 5s~50s, increment of each click is 5s, parameter can be set only when battery type is USER and LFP 14/ 15/ 16,M13 13/ 14 |
| 14 | Battery under-voltage alarm | 44 | When the battery voltage falls below this voltage point, alarm will be displayed on the screen and indicator. Setting range: 40V~52V, increment of each click is 0.4V, parameter can be set only when battery type is USER and L14/15/16,M13/14 |
| 15 | Battery under-voltage limit voltage | 40 | When the battery voltage falls below this voltage point, the inverter output is switched off immediately. Setting range is 40V~52V, increment of each click is 0.4V, parameter can be set only when battery type is USER and L14/15/16,M13/14 |
| 16 | Battery equalization charging | 015 | Disable equalization charging. |

| | | | |
|----|--|--------------------|---|
| | | ENA default | Enable equalization charging, parameter can be set only when battery type is FLd\SLd\USER |
| 17 | Battery equalization charging voltage | 58 | Setting range: 48V~58V, increment of each click is 0.4V, parameter can be set only when battery type is FLd\SLd\USER |
| 18 | Battery equalization charging duration | 120 | Setting range: 5min~900min, increment of each click is 5min, parameter can be set only when battery type is FLd\SLd\USER |
| 19 | Battery equalization charging delay time | 120 | Setting range: 5min~900min, increment of each click is 5min, parameter can be set only when battery type is FLd\SLd\USER |
| 20 | Battery equalization charging interval | 30 | Setting range: 0~30 days, increment of each click is 1 day, parameter can be set only when battery type is FLd\SLd\USER |
| 21 | Battery equalization charging stop-start | dis default | Stop equalization charging immediately. |
| | | ENA | Start equalization charging immediately. |
| 22 | Power saving mode | dis default | Disable power saving mode. |
| | | ENA | Enable power saving mode, When the load power below 50W, the inverter output will switch off after a 5min delay . When the load is more than 50W, the inverter automatic restart. |
| 23 | Over-load restart | dis | When overload occurs and the output is switched off, the machine will not restart. |
| | | ENA default | When overload occurs and the output is switched off, the machine will restart after a delay of 3 minutes. After it reaches 5 cumulative time, the machine will not restart automatically. |
| 24 | Over-temperature restart | dis | When over temperature occurs and the output is switched off, the machine will not restart. |
| | | ENA default | When overload occurs and the output is switched off, the machine will restart when the temperature drops. |
| 25 | Buzzer alarm | dis | Disable buzzer alarm. |
| | | ENA default | Enable buzzer alarm. |

| | | | |
|----|-------------------------------------|--------------------|--|
| 26 | Power source switching reminder | dis | Disable reminder when the status of the input power source changes. |
| | | ENA <i>default</i> | Enable reminder when the status of the input power source changes. |
| 27 | Inverter overload switch to bypass | dis | Disable switch to the bypass when the inverter is overload. |
| | | ENA <i>default</i> | Enable switch to the bypass when the inverter is overload. |
| 28 | Max. utility charging current | 60 | POW-SunSmart 8K, setting range: 0~100A. |
| | | | POW-SunSmart 10K, setting range: 0~120A. |
| 30 | RS485 address | 18: 1 | RS485 address setting range: 1~254. |
| 34 | Feed back & hybrid output function | dis <i>default</i> | Disable this function. |
| | | MIX LOD | When parameter 01 = 171, the solar energy is prioritised to charge the batteries and any excess energy will be used to power the load. With an anti-backflow function, the PV energy is not feed back into the grid. |
| | | ON GRD | When parameter 01 = 171, solar energy will feed back into the grid when battery is full or disconnected. |
| 35 | Battery under voltage recover point | 52 | Battery recover discharge from under voltage protection when voltage above this value. Setting range: 44V~54V. |
| 37 | Battery full recharge voltage point | 52 | Inverter stops charging when the battery is full. Inverter resumes charging when the battery voltage below this value. Setting range: 44V~54V. |
| 38 | AC output voltage | 120 | Setting range: 100/105/110/120Vac |
| 39 | AC output phase mode | 0 | 0 stands for single-phase mode. Assume parameter 38= 120V. The phase difference of L1-L2 is 0 degree, L1/L2 in parallel connection, therefore L1-N/L2-N voltage is 120V. Setting allowed only when output is switched off. |
| | | 180 <i>default</i> | 180 stands for split-phase mode. Assume parameter 38= 120V, The phase difference of L1-L2 is 180 degree, therefore L1-N/L2-N voltage is 120V, L1-L2 voltage is 120*2=240V. Setting allowed only when output is switched off. |

| | | | |
|----|--------------------------------|-------------|---|
| 40 | 1st slot start charging | 00:00:00 | Setting range: 00:00:00-23:59:00 |
| 41 | 1st slot end charging | 00:00:00 | Setting range: 00:00:00-23:59:00 |
| 42 | 2nd slot start charging | 00:00:00 | Setting range: 00:00:00-23:59:00 |
| 43 | 2nd slot end charging | 00:00:00 | Setting range: 00:00:00-23:59:00 |
| 44 | 3rd slot start charging | 00:00:00 | Setting range: 00:00:00-23:59:00 |
| 45 | 3rd slot end charging | 00:00:00 | Setting range: 00:00:00-23:59:00 |
| 46 | Time slot charging function | dis default | Disable this function. |
| | | ENA | Enable this function, AC output source mode will switch to 5W, utility charging the battery and carry load only in charging time slot which user set or the battery is under voltage. |
| 47 | 1st slot start discharging | 00:00:00 | Setting range: 00:00:00-23:59:00 |
| 48 | 1st slot end discharging | 00:00:00 | Setting range: 00:00:00-23:59:00 |
| 49 | 2nd slot start discharging | 00:00:00 | Setting range: 00:00:00-23:59:00 |
| 50 | 2nd slot end discharging | 00:00:00 | Setting range: 00:00:00-23:59:00 |
| 51 | 3rd slot start discharging | 00:00:00 | Setting range: 00:00:00-23:59:00 |
| 52 | 3rd slot end discharging | 00:00:00 | Setting range: 00:00:00-23:59:00 |
| 53 | Time slot discharging function | dis default | Disable this function. |
| | | ENA | Enable this function, AC output source mode will switch to UTI , battery discharging only in discharging time slot which user set or utility is not available. |
| 54 | Local date | 00:00:00 | YY/MM/DD. Setting range: 00:01:01-99:12:31 |
| 55 | Local time | 00:00:00 | Setting range: 00:00:00-23:59:59 |
| 57 | Stop charging current | 2 | Charging stops when the charging current is less than the set value (unit:amp) |

| | | | |
|----|---|-------------|---|
| 58 | Discharging alarm SOC | 15 | Triggers an alarm when the battery SOC is less than the set value (unit:%) |
| 59 | Discharging cutoff SOC | 5 | Stops discharging when the battery SOC is less than the set value (unit:%) |
| 60 | Charging cutoff SOC | 100 | Stops charging when the battery SOC is touch the set value (unit:%) |
| 61 | Switching to utility SOC | 10 | Switch to utility power when the battery SOC is less than this setting (unit:%) |
| 62 | Switching to inverter SOC | 100 | Switches to inverter output mode when SOC is greater than this setting (unit:%) |
| 63 | N-PE bonding automatic switching function | dis default | Allow automatic switching of N-PE bonding |
| | | ENR | Prohibit automatic switching of N-PE bondin |

■ AC output mode

The AC output mode corresponds to parameter setting item 01 and 34, which allows the user to set the AC output power source manually.

● Utility Priority Output 0 | UTI (default)

Utility at first priority, utility and solar provide power to load at the same time when solar is available, battery will provide power to load only when utility power is not available. (Priority: utility>solar>battery)

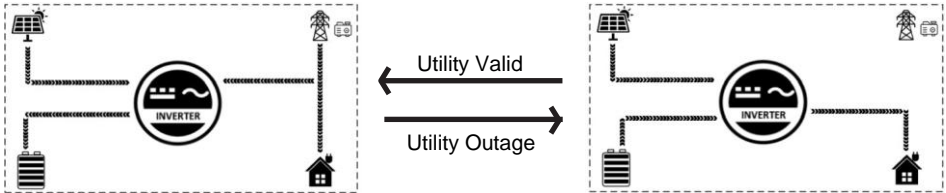

● Solar and Utility Hybrid Output 34 MIX LOO

In UTI mode, when not connected to the battery or when the battery is full, the solar and the utility supply power to the load at the same time. (Priority: solar>utility>battery)



● Solar Priority Output 0 | SOL

Solar provides power to the loads as first priority. If solar is not sufficient or not available, the utility will be used as a supplement to provide power to the loads. This mode maximises solar energy while maintaining battery power and is suitable for areas with relatively stable power grids. (Priority: solar>utility>battery)

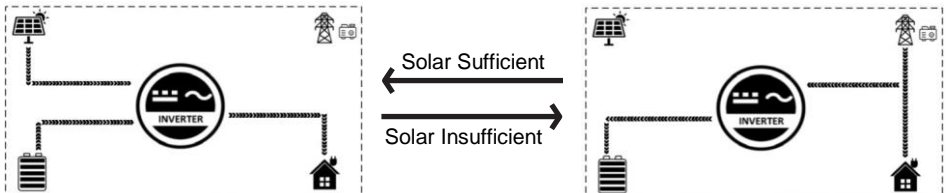

● **Inverter Priority Output** $\text{U} \mid \text{SbU}$

Solar provides power to the loads as first priority. If solar is not sufficient or not available, the battery will be used as a supplement to provide power to the loads. When the battery voltage reaches the value of parameter $\text{U}4$ (Voltage point of battery switch to utility) will switch to utility to provide power to the load, This model makes maximum use of DC energy and is used in areas where the grid is stable. (Priority: solar>battery>utility)

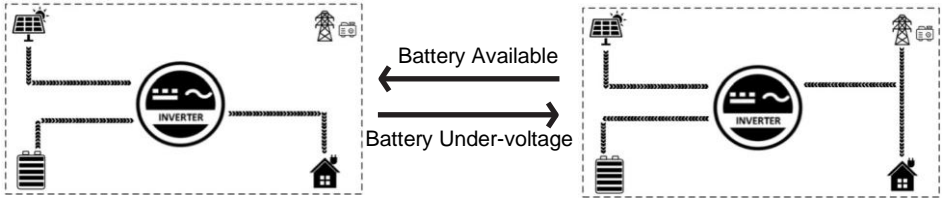

■ **Battery charging mode**

The charging mode corresponds to parameter setting item U5 , which allows the user to set the charging mode manually.

● **Hybrid Charging** SbU (default)

Solar and utility charging the battery at the same time, solar at the first priority, utility power as a supplement when solar power is not sufficient. This is the fastest way to charge and is suitable for areas with low power supply, providing customers with sufficient back-up power. (Source priority: solar>utility)

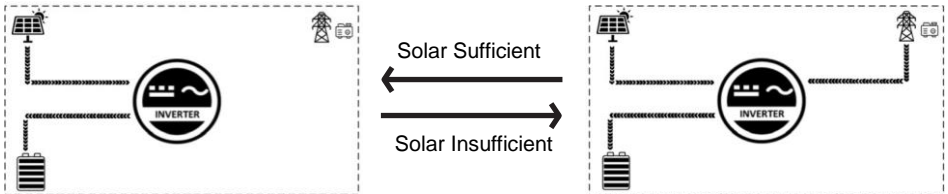

● **Utility Priority Charging** $\text{U} \mid \text{U}$

The utility power gives priority to charging the battery, and PV charging is only activated when the utility power is not available. (Source priority: utility>solar)

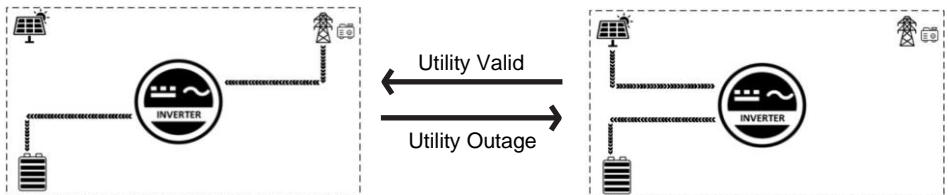

● Solar Priority Charging C50

Solar priority charging, with utility charging only activated when the solar fails. By making full use of solar power during the day and switching to utility charging at night, battery power can be maintained and is suitable for applications in areas where the grid is relatively stable and electricity prices are more expensive. (Source priority: solar>utility)

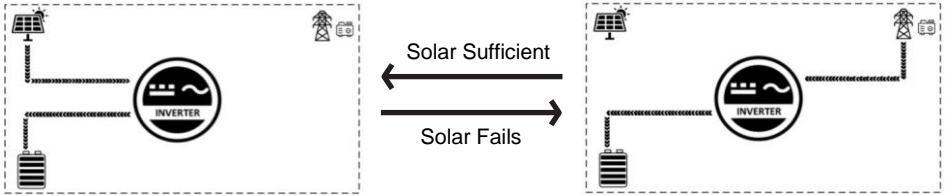

● Only Solar Charging C50

Solar charging only, no mains charging is activated. This is the most energy-efficient method, with all the battery power coming from solar energy, and is usually used in areas with good radiation conditions.

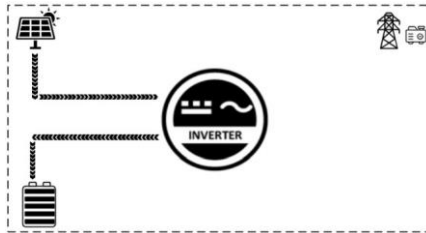

■ Time-slot charging/discharging function

The POW-SunSmart series is equipped with a time-slot charging and discharging function, which allows users to set different charging and discharging periods according to the local peak and valley tariffs, so that the utility power and PV energy can be used rationally.

When mains electricity is expensive, the battery inverter is used to carry the load; when the mains electricity is cheap, the mains electricity is used to carry the load and charge, which can help customers to save electricity costs to the greatest extent.

The user can turn on/off the time-slot charging/discharging function in setup menu parameter 46 and 53. and set charging and discharging slot in parameter 40-45, 47-52. Below are examples for users to understand the function.

NOTICE

Before using this function for the first time, please set the local time in parameter items 54, 55, then the user can set the corresponding time slot according to the local peak and valley tariff charges.

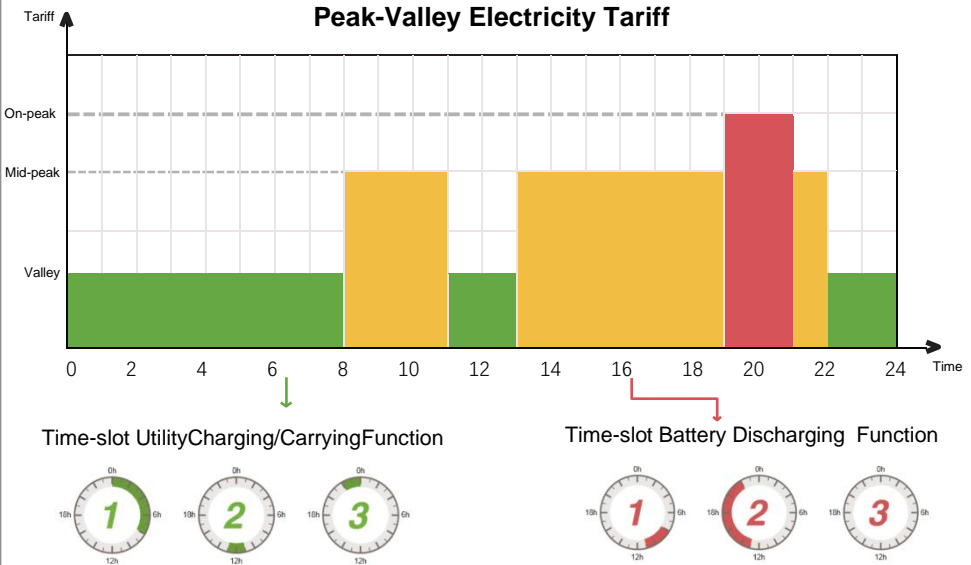

With 3 definable periods, the user can freely set the mains charging/carrying time within the range of 00:00 to 23:59. During the time period set by the user, if PV energy is available, PV energy will be used first, and if PV energy is not available or insufficient, utility energy will be used as a supplement.

With 3 definable time periods, users can freely set the battery discharge time within the range of 00:00 to 23:59. During the time period set by the user, the inverter will give priority to the battery inverter to carry the load, and if the battery power is insufficient, the inverter will automatically switch to mains power to ensure stable

■ Battery parameter

● Lead-acid battery

| Parameter/Battery type | Sealed | Gel | Flooded | User-defined |
|--------------------------------|--------|--------|---------|-------------------|
| | SLd | GEL | FLd | USER |
| Over-voltage cut-off voltage | 60V | 60V | 60V | 60V |
| Equalization charging voltage | 58V | 56.8V | 58V | 40~60V settable |
| Bulk charging voltage | 57.7V | 56.8V | 57.6V | 40~60V settable |
| Float charging voltage | 55.2V | 55.2V | 55.2V | 40~60V settable |
| Under-voltage alarm voltage | 44V | 44V | 44V | 40~60V settable |
| Under-voltage cut-off voltage | 42V | 42V | 42V | 40~60V settable |
| Discharging limit voltage | 40V | 40V | 40V | 40~60V settable |
| Over-discharge delay time | 5s | 5s | 5s | 1~30s settable |
| Equalization charging duration | 120min | - | 120min | 0~600min settable |
| Equalization charging interval | 30d | - | 30d | 0~250d settable |
| Bulk charging duration | 120min | 120min | 120min | 10~600m settable |

NOTICE

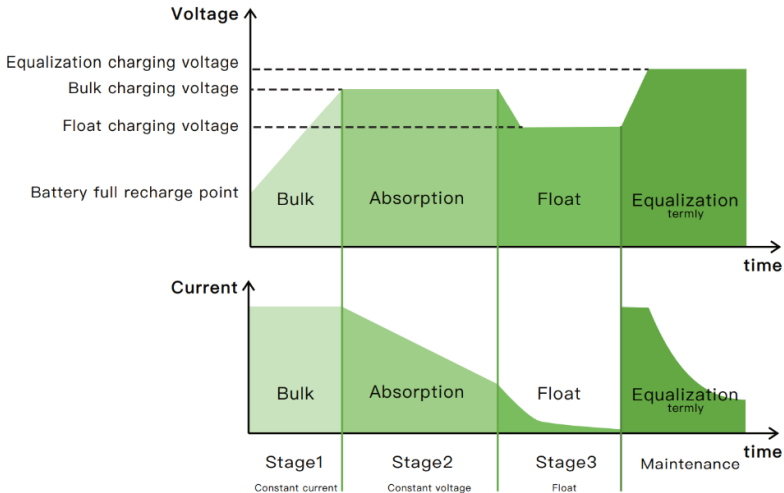

● Li-ion battery

| Parameter/Battery type | Ternary | | LFP | | | User-defined |
|--------------------------------|-----------------|-----------------|-----------------|-----------------|-----------------|--------------------|
| | N13 | N14 | L16 | L15 | L14 | USER |
| Over-voltage cut-off voltage | 60V | 60V | 60V | 60V | 60V | 60V |
| Equalization charging voltage | - | - | - | - | - | 40~60V settable |
| Bulk charging voltage | 53.2V | 57.6V | 56.8V | 53.2V | 49.2V | 40~60V settable |
| Float charging voltage | 53.2V | 57.6V | 56.8V | 53.2V | 49.2V | 40~60V settable |
| Under-voltage alarm voltage | 43.6V | 46.8V | 49.6V | 46.4V | 43.2V | 40~60V settable |
| Under-voltage cut-off voltage | 38.8V | 42V | 48.8V | 45.6V | 42V | 40~60V settable |
| Discharging limit voltage | 36.4V | 39.2V | 46.4V | 43.6V | 40.8V | 40~60V settable |
| Over-discharge delay time | 30s | 30s | 30s | 30s | 30s | 1~30s settable |
| Equalization charging duration | - | - | - | - | - | 0~600min settable |
| Equalization charging interval | - | - | - | - | - | 0~250d settable |
| Bulk charging duration | 120min settable | 120min settable | 120min settable | 120min settable | 120min settable | 10~600min settable |

NOTICE

If no BMS is connected, the inverter will charge according to the battery voltage with a preset charging curve. When the inverter communicates with the BMS, it will follow the BMS instructions

instructions

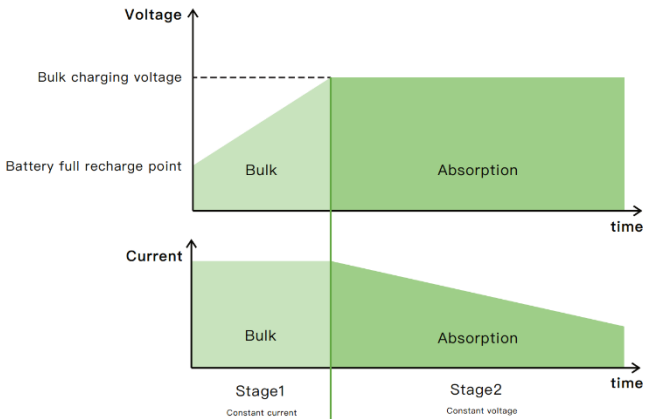

Communication

Overview

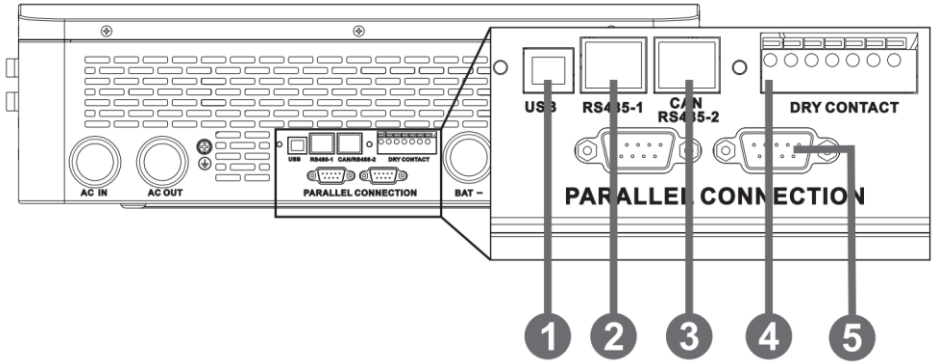

| | | | | | |
|---|------------------|---|--|---|--------------|
| 1 | USB-B port | 2 | RS485-1 port | 3 | RS485-2 port |
| 4 | Dry contact port | 5 | Parallel connection port (reserved port, this model does not support parallel connection) | | |

USB-B port

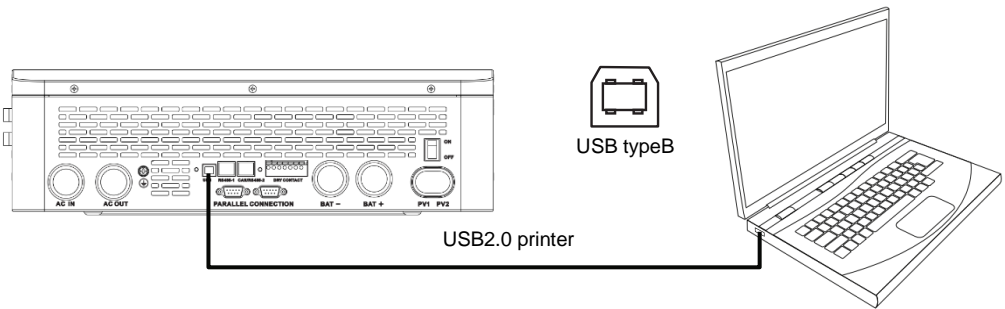

The user can read and modify device parameters through this port by using the host software.

Please contact us for the host software installation package if you require one.

■ Dry contact

Dry contact port with 4 functions:

1. Remote switch on/off
2. Switching signal output
3. Battery temperature sampling
4. Generator remote start/ stop

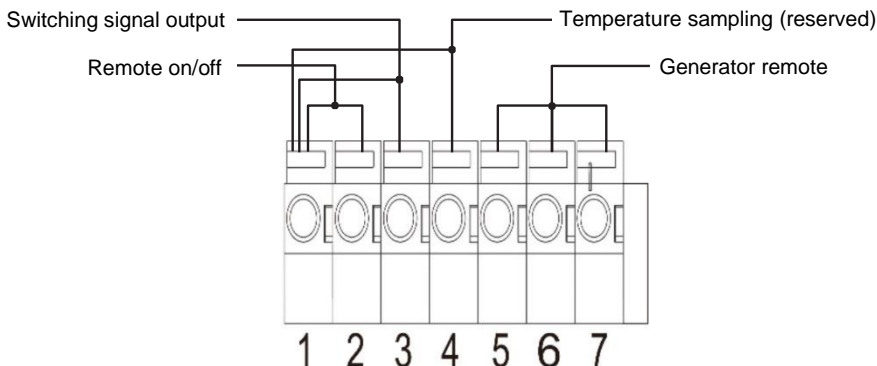

| Function | Description |
|---------------------------------|---|
| Remote switch on/off | When pin 1 is connected with pin 2, the inverter will switched off the AC output. When pin1 is disconnected from pin2, the inverter outputs normally. |
| Switching signal output | When the voltage of battery reaches the under-voltage limit voltage (parameter 15) , pin 3 to pin 1 voltage is 0V, When the battery charging/discharging normally pin 3 to pin 1 voltage is 5V. |
| Temperature sampling (reserved) | Pin 1 & Pin 4 can be used for battery temperature sampling compensation. |
| Generator remote start/stop | When the voltage of battery reaches the under-voltage alarm voltage (parameter14) or voltage point of utility switch to battery (parameter 04), pin 6 to pin 5 normal open, pin 7 to pin 5 normal close. When the voltage of battery reaches the voltage point of battery switch to utility (parameter05) or battery is full. pin 6 to pin 5 normal close, pin 7 to pin 5 normal open. (Pin 5/6/7 outputs 125Vac/1A, 230Vac/1A,30Vdc/1A) |

NOTICE

If you need to use the remote start/stop function of the generator with dry contact, ensure that the generator has ATS and supports remote start/stop.

Fault and Remedy

Faultcode

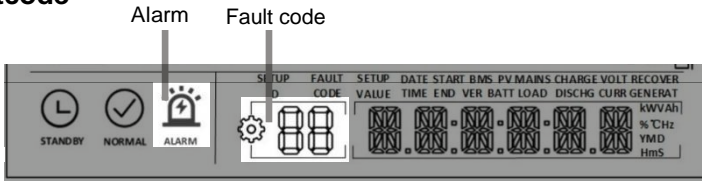

| Fault Code | Meaning | Does it Affect the outputs | Instructions |
|------------|------------------|----------------------------|---|
| 01 | BatVoltLow | Yes | Battery under-voltage alarm |
| 02 | BatOverCurrSw | Yes | Battery discharge over-current, software protection |
| 03 | BatOpen | Yes | Battery disconnected alarm |
| 04 | BatLowEod | Yes | Battery under-voltage stop discharging alarm |
| 05 | BatOverCurrHw | Yes | Battery over-current hardware protection |
| 06 | BatOverVolt | Yes | Battery over-voltage protection |
| 07 | BusOverVoltHw | Yes | Busbar over-voltage hardware protection |
| 08 | BusOverVoltSw | Yes | Busbar over-voltage software protection |
| 09 | PvVoltHigh | Yes | PV input over-voltage protection |
| 10 | PvBoostOCSw | No | Boost circuit over-current software protection |
| 11 | PvBoostOCHw | No | Boost circuit over-current hardware protection |
| 12 | SpiCommErr | Yes | Master-slave chip SPI communication failure |
| 13 | OverloadBypass | Yes | Bypass overload protection |
| 14 | OverloadInverter | Yes | Inverter overload protection |
| 15 | AcOverCurrHw | Yes | Inverter over-current hardware protection |
| 16 | AuxDSpReqOffPWM | Yes | Slave chip request switch off |

| | | | |
|----|--------------------|-----|--|
| | | | failure |
| 17 | InvShort | Yes | Inverter short-circuit protection |
| 18 | Bussoftfailed | Yes | Busbar soft start failure |
| 19 | OverTemperMppt | No | MPPT heat sink over-temperature protection |
| 20 | OverTemperInv | Yes | Inverter heat sink over-temperature protection |
| 21 | FanFail | Yes | Fan failure |
| 22 | EEPROM | Yes | Reservoir failure |
| 23 | ModelNumErr | Yes | Wrong model |
| 24 | Busdiff | Yes | Busbar voltage imbalance |
| 25 | BusShort | Yes | Busbar short circuit |
| 26 | Rlyshort | Yes | Inverter output back flow to bypass |
| 28 | LinePhaseErr | Yes | Utility input phase fault |
| 29 | BusVoltLow | Yes | Busbar under-voltage protection |
| 30 | BatCapacityLow1 | No | Battery SOC below 10% alarm (Only enable BMS take effect) |
| 31 | BatCapacityLow2 | No | Battery SOC below 5% alarm (Only enable BMS take effect) |
| 32 | BatCapacityLowStop | Yes | Battery dead (Only enable BMS take effect) |
| 58 | BMSComErr | No | BMS communication failure |
| 59 | BMSErr | No | BMS failures occur |
| 60 | BMSUnderTem | No | BMS under-temperature alarm (Only enable BMS take effect) |
| 61 | BMSOverTem | No | BMS over-temperature alarm (Only enable BMS take effect) |
| 62 | BMSOverCur | No | BMS over-current alarm (Only enable BMS take effect) |
| 63 | BMSUnderVolt | No | BMS under-voltage alarm (Only enable BMS take effect) |
| 64 | BMSOverVolt | No | BMS over-voltage alarm (Only enable BMS take effect) |

■ Trouble shooting

| Fault Code | Meaning | Causality | Remedy |
|------------|---|--|---|
| / | Screen no display | No power input, or in sleep mode. | Closing the circuit breaker. Ensure the rocker switch is ON. Push any button on the panel to exit sleep mode. |
| 01 | Battery under-voltage | The battery voltage is lower than the value set in parameter [14]. | Charge the battery and wait until the battery voltage is higher than the value set in the parameter item [14]. |
| 03 | Battery not connected | The battery is not connected, or the BMS in discharge protection | Check whether the battery is reliably connected; check whether the circuit breaker of the battery is not closed; ensure that the BMS of the Li-ion battery can communicate properly. |
| 04 | Battery over-discharge | The battery voltage is lower than the value set in the parameter [12]. | Manual reset: Power off and restart. Automatic reset: charge the battery so that the battery voltage is higher than the value set in the parameter item [35]. |
| 06 | Battery over-voltage when charging | Battery is in over-voltage condition. | Manually power off and restart. Check to see if the battery voltage exceeds the limit. If it exceeds, the battery needs to be discharged until the voltage is below the battery's over-voltage recovery point. |
| 13 | Bypass over-load (software detection) | Bypass output power or output current overload for a certain period of time. | Reduce the load power and restart the device. Please refer to item 11 of the protection features for more details. |
| 14 | Inverter over-load (software detection) | Inverter output power or output current overload for a certain period of time. | |
| 19 | Heat sink of PV input over- | Heat sink of PV input temperature exceeds | Resume normal charge and discharge when the temperature |

| | | | |
|----|--|---|--|
| | temperature (software detection) | 90°C for 3s. | of the heat sink has cooled to below the over-temperature recovery temperature. |
| 20 | Heat sink of inversion over-temperature (software detection) | Heat sink of inversion temperature exceeds 90°C for 3s. | |
| 21 | Fan failure | Fan failure detects by hardware for 3s. | Manually toggle the fan after switching off to check for blockage by foreign objects. |
| 26 | AC Input relay short- circuit | Relay for AC input sticking | Manually power off and restart; if the fault reappears after restarting, You need to contact the after-sales service to repair the machine. |
| 28 | Utility input phase fault | AC input phase does not coincide with AC output phase | Ensure that the phase of the AC input is the same as the phase of the AC output, e.g. if the output is in split-phase mode, the input must also be in split-phase. |

NOTICE

If you encounter a fault with the product that cannot be solved by the methods in the table above, please contact our after-sales service for technical support and do not disassemble the equipment yourself.

Protection and Maintenance

■ Protection features

| No. | Protection Feature | Instruction |
|-----|--|--|
| 1 | PV input current/power limiting protection | When the charging current or power of the PV array configured exceeds the PV input rated value, the inverter will limit the input power and charge at the rated. |
| 2 | PV input over-voltage | If the PV voltage exceeds the maximum value allowed by the hardware, the machine will report a fault and stop the PV boost to output a sinusoidal AC wave. |
| 3 | PV night reverse current protection | At night, the battery is prevented from discharging through the PV module because the battery voltage is greater than the voltage of PV module. |
| 4 | AC input over-voltage protection | When the AC input voltage of each phase exceeds 140V, the mains charging will be stopped and switched to the inverter mode. |
| 5 | AC input under-voltage protection | When the AC input voltage of each phase below 90V, the utility charging will be stopped and switched to the inverter mode. |
| 6 | Battery over-voltage protection | When the battery voltage reaches the over-voltage cut-off point, the PV and the utility will automatically stop charging to prevent the battery from being overcharged and damaged. |
| 7 | Battery under-voltage protection | When the battery voltage reaches the under-voltage cut-off point, the inverter will automatically stop the battery discharge to prevent damage from over-discharging the battery. |
| 8 | Battery over-current protection | After a period when the battery current exceeds that allowed by the hardware, the machine will switch off the output and stop discharging the battery. |
| 9 | AC output short-circuit protection | When a short-circuit fault occurs at the load output terminal, the AC output is immediately turned off and turned on after 1 second. If the output load terminal is still short-circuited after 3 attempts, the inverter must be manually restarted after first removing the short-circuit fault from the load before the normal output can be restored. |
| 10 | Heat sink over-temperature protection | When the internal temperature of the inverter is too high, the inverter will stop charging and discharging; when the temperature returns to normal, the inverter will resume charging and discharging. |
| 11 | Inverter over-load protection | After triggering the overload protection the inverter will resume output after 3 minutes, 5 consecutive overloads will switch off the output until the inverter is restarted. (102%<load<110%) ±10%: error and output shutdown after 5min; (110% < load < 125%) ±10%: error and output |

| | | |
|----|---------------------------------------|---|
| | | shutdown after 10s. Load > 125% ±10%: error reported and output switched off after 5s. |
| 12 | AC output reverse | Prevents AC back flow from the battery inverter to the bypass AC input. |
| 13 | Bypass over-current protection | Built-in AC input over-current protection circuit breaker. |
| 14 | Bypass phase inconsistency protection | When the phase of the bypass input and the phase of the inverter split do not match, the inverter disables switching to the bypass output to prevent the load from dropping out or short-circuiting when switching to the bypass. |

■ Maintenance

To maintain optimum and long-lasting working performance, we recommend that the following items are checked twice a year.

1. Ensure that the airflow around the inverter is not blocked and remove any dirt or debris from the radiator.
2. Check that all exposed conductors are not damaged by sunlight, friction with other surrounding objects, dry rot, insect or rodent damage, etc. The conductors need to be repaired or replaced if necessary.
3. Verify that the indications and displays are consistent with the operation of the equipment, note any faults or incorrect displays and take corrective action if necessary.
4. Check all terminals for signs of corrosion, insulation damage, high temperatures or burning/discolouration and tighten terminal screws.
5. Check for dirt, nesting insects and corrosion, clean as required. Clean the insect screen regularly.
6. If the lightning arrester has failed, replace the failed arrester in time to prevent lightning damage to the inverter or other equipment of the user.

DANGER

Make sure that the inverter is disconnected from all power sources and that the capacitors are fully discharged before carrying out any checks or operations to avoid the risk of electric shock.

The Company shall not be liable for damage caused by :

1. Damage caused by improper use or use in a wrong location.
2. Photovoltaic modules with an open circuit voltage exceeding the maximum permissible voltage.
3. Damage caused by the operating temperature exceeding the restricted operating temperature range
4. Dismantling and repair of the inverter by unauthorised persons.
5. Damage caused by force majeure: damage during transport or handling of the inverter.

Datasheet

| MODEL | POW-SunSmart 8K | POW-SunSmart 10K | CAN BE SET |
|--------------------------------------|--|------------------|------------|
| INVERTER OUTPUT | | | |
| Rated Output Power | 8,000W | 10,000W | |
| Max.Peak Power | 16,000W | 20,000W | |
| Rated Output Voltage | 120/240Vac (split phase/single phase) | | Y |
| Load Capacity of Motors | 5HP | 6HP | |
| Rated AC Frequency | 50/60Hz | | Y |
| Waveform | Pure Sine Wave | | |
| Switch Time | 10ms (typical) | | |
| Parallel capacity | / | | |
| Overload | <p>After triggering the overload protection the inverter will resume output after 3 minutes, 5 consecutive overloads will switch off the output until the inverter is restarted.</p> <p>(102%<load<110%) ±10%: error and output shutdown after 5min;</p> <p>(110% < load < 125%) ±10%: error and output shutdown after 10s.</p> <p>Load > 125% ±10%: error reported and output switched off after 5s.</p> | | |
| BATTERY | | | |
| Battery Type | Li-ion / Lead-Acid / User Defined | | Y |
| Rated Battery Voltage | 48Vdc | | |
| Voltage Range | 40-60Vdc | | Y |
| Max.MPPT Charging Current | 200A | | Y |
| Max.Mains/Generator Charging Current | 100A | 120A | Y |
| Max.Hybrid Charging Current | 180A | 200A | Y |

| PV INPUT | | |
|----------------------------------|---|---|
| Num. of MPP Trackers | 2 | |
| Max.PV array power | 11,000W | |
| Max.input current | 22/22A | |
| Max.Voltage of Open Circuit | 500Vdc | |
| MPPT Voltage Range | 125-425Vdc | |
| MAINS / GENERATOR INPUT | | |
| Input Voltage Range | 90-140Vac | |
| Frequency Range | 50/60Hz | |
| Bypass Overload Current | 63A | |
| EFFICIENCY | | |
| MPPT Tracking Efficiency | 99.9% | |
| Max. Battery Inverter Efficiency | 92% | |
| GENERAL | | |
| Dimensions | 620*445*130mm (2*1.5*0.4ft) | |
| Weight | 27kg (59.5lb) | |
| Protection Degree | IP20, Indoor Only | |
| Operating Temperature Range | -10~55℃, >45℃ derated (14~131℉, >113℉ derated) | |
| Noise | <60dB | |
| Cooling Method | Internal Fan | |
| Warranty | 2 Years | |
| COMMUNICATION | | |
| Embedded Interfaces | RS485 / CAN / USB / Dry contact | Y |
| External Modules (Optional) | Wi-Fi / GPRS | Y |
| CERTIFICATION | | |
| Safety | IEC62109-1, IEC62109-2, UL1741 | |
| EMC | EN61000-6-1, EN61000-6-3, FCC 15 class B | |
| RoHS | Yes | |



POWMr

SHENZHEN HEHEJIN INDUSTRIAL CO.,LTD

Tel/Fax: +86 755-28219903

Email: support@powmr.com

Web: www.powmr.com

Add: Henggang Street, Longgang District, Shenzhen, Guangdong, China