

INSTRUCTIONS

INSTRUCCIONES

INSTRUCTIONS

ISTRUZIONI

INSTRUÇÕES

ANWEISUNGEN

INSTRUKSJONER

INSTRUCTIES

DIREKTIV

SUUNTASARJA

N.A. = North America**EU = Europe**

Safety warning: Always wear safety glasses or eye shields before commencing power tool operation. Follow your manufacturer's instructions for safety when using this attachment. Always wear protective eyewear when operating power tools. Always keep hands at a safe distance from spindles and cutting tools. Always disconnect power source before working with power tools.

Advertencia de seguridad: Lleve siempre gafas de seguridad o protectores de ojos antes de empezar la operación con herramientas eléctricas. Siga las instrucciones de su fabricante referentes a la seguridad al usar este accesorio. Lleve siempre protectores de ojos al operar herramientas eléctricas. Mantenga siempre las manos a una distancia segura de los husillos y las herramientas de corte. Desconecte siempre la fuente de alimentación antes de trabajar con esta clase de herramientas.

Avertissement de sécurité: toujours porter des lunettes de sécurité ou un masque facial lors de l'utilisation de l'outil. Lorsque cet accessoire est utilisé, suivre les instructions de sécurité du fabricant. Toujours porter une protection oculaire lors de l'utilisation d'outils motorisés. Toujours garder les mains à l'écart des broches et outils de coupe. Toujours débrancher l'outil avant d'installer l'accessoire.

WARNING! Använd alltid skyddsglasögon eller andra ögonskydd innan du börjar arbeta med elverktyget. Följ alltid tillverkarens säkerhetsanvisningar när du använder tillbehöret. Använd alltid skyddsglasögon när du jobbar med elverktyg. Håll händerna på säkert avstånd från spindlar och skärande verktyg. Dra alltid ur sladden innan du arbetar på elverktyget.

Sicherheitshinweis: Vor dem Einschalten des Elektrowerkzeugs stets eine Schutzbrille oder einen Augenschutz aufsetzen. Bei Verwendung dieses Zubehöerteils die Sicherheitshinweise des Herstellers befolgen. Beim Arbeiten mit Elektrowerkzeugen stets einen Augenschutz aufsetzen. Hände stets in sicherem Abstand von Frässpindeln und Schneidwerkzeugen halten. Vor allen Arbeiten an Ihrem Elektrowerkzeug stets den Netzstecker aus der Steckdose ziehen.

Sikkerhedsadvarsel: Benyt altid beskyttelsesbriller eller ansigtsskjold, før du anvender elværktøj. Følg producentens sikkerhedsanvisninger, når du bruger denne anordning. Benyt altid beskyttelsesbriller, når du anvender elværktøj. Hold altid hænderne i sikker afstand af spindler og skæreværktøj. Kobl altid strømforsyningen fra før du anvender elværktøj.

Varoitus: Käytä aina suojalaseja tai silmäsuojaimia, kun käytät sähkötyökaluja. Noudata valmistajan turvaohjeita, kun käytät tätä lisälaitetta. Käytä aina suojalaseja käyttäessäsi sähkötyökaluja. Pidä kädet aina turvallisen välimatkan päässä karoista ja leikkaustyökaluista. Irrota sähkötyökalut aina virtalähteestä, ennen kuin teet niille mitään toimenpiteitä.

INSTRUCTIONS

INSTRUCCIONES

INSTRUCTIONS

ISTRUZIONI

INSTRUÇÕES

ANWEISUNGEN

INSTRUKSJONER

INSTRUCTIES

DIREKTIV

SUUNTASARJA

N.A. = North America

EU = Europe

Veiligheidswaarschuwing: Draag altijd een veiligheidsbril of oogbeschermers voordat u met elektrisch gereedschap gaat werken. Volg de veiligheidsinstructies op van uw fabrikant wanneer u dit hulpstuk gebruikt. Draag altijd oogbeschermers wanneer u met elektrisch gereedschap werkt. Blijf altijd met uw handen op veilige afstand van assen en snijgereedschap. Haal altijd de stekker uit het stopcontact voordat u met elektrisch gereedschap werkt.

Sikkerhetsvarsel: Bruk alltid sikkerhetsbriller eller annen øyebeskyttelse før du begynner å bruke elektroverktøy. Følg produsentens sikkerhetsinstruksjoner når du bruker dette tilbehøret. Bruk alltid beskyttelsesbriller når du bruker elektroverktøy. Hold alltid hendene i trygg avstand fra spindler og skjæreverktøy. Koble alltid fra strømkilden før du arbeider med elektroverktøy.

Avvertenza sulla sicurezza: indossare sempre occhiali o maschere di protezione prima di iniziare a utilizzare gli strumenti elettrici. Seguire le istruzioni del produttore sulla sicurezza quando si utilizza questo accessorio. Indossare sempre occhiali protettivi quando si utilizzano strumenti elettrici. Tenere sempre le mani a una distanza di sicurezza da mandrini e strumenti da taglio. Scollegare sempre l'alimentazione elettrica prima di utilizzare gli strumenti elettrici.



< 18"
< 46 cm

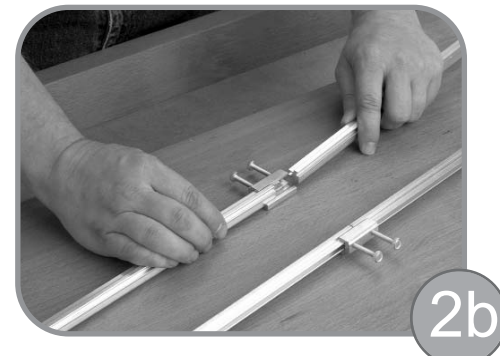

< 36"
< 92 cm

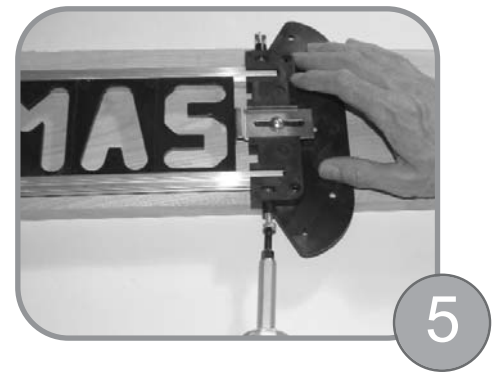
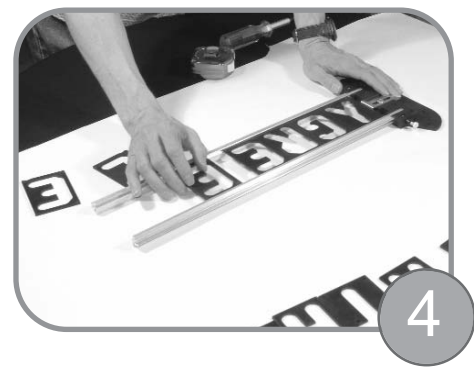

INSTRUCTIONS

INSTRUCCIONES

INSTRUCTIONS

ISTRUZIONI

INSTRUÇÕES

ANWEISUNGEN

INSTRUKSJONER

INSTRUCTIES

DIREKTIV

SUUNTASARJA

N.A. = North America

EU = Europe

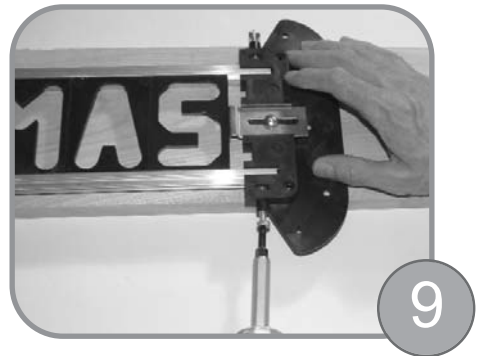
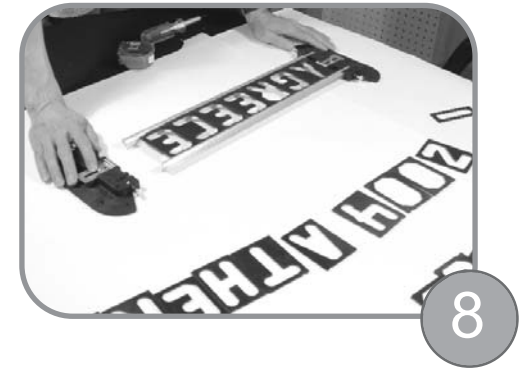

N.A.

EU



INSTRUCTIONS

INSTRUCCIONES

INSTRUCTIONS

ISTRUZIONI

INSTRUÇÕES

ANWEISUNGEN

INSTRUKSJONER

INSTRUCTIES

DIREKTIV

SUUNTASARJA

N.A. = North America

EU = Europe

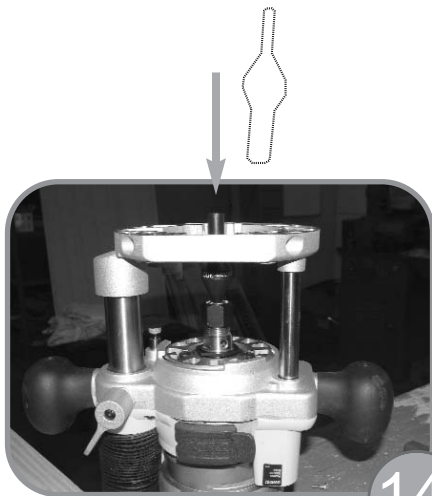

14

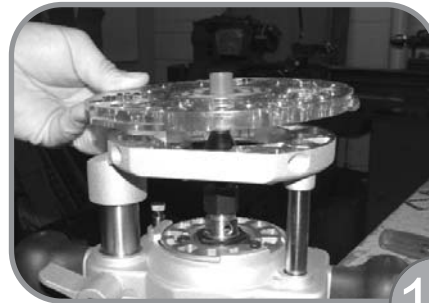

15

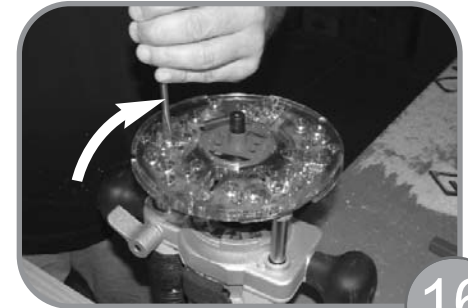

16

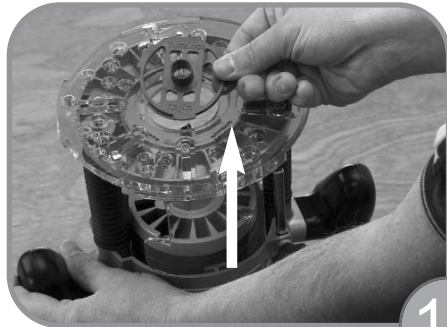

17

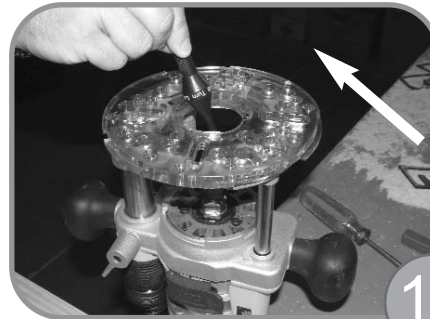

18

EU

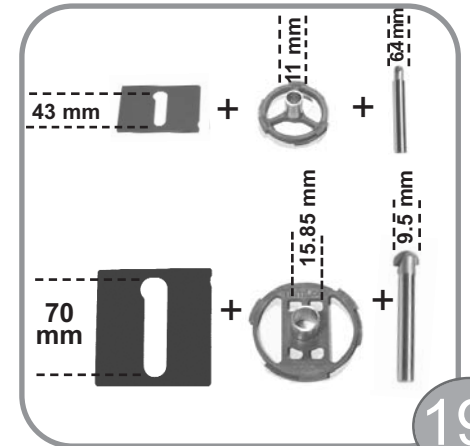

19a

N.A.

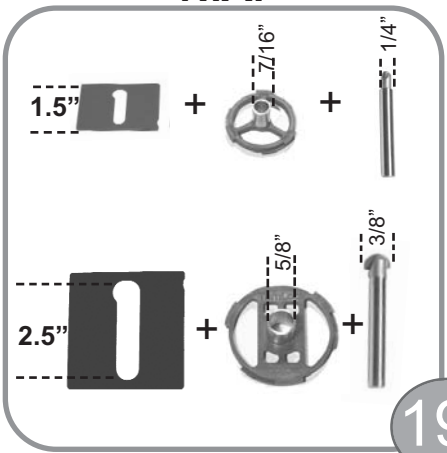

19b

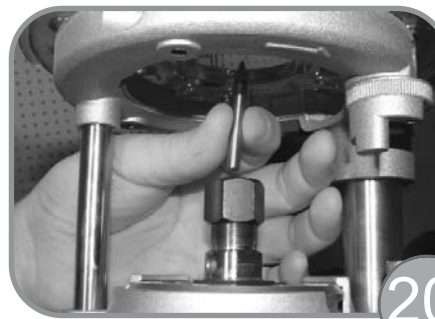

20

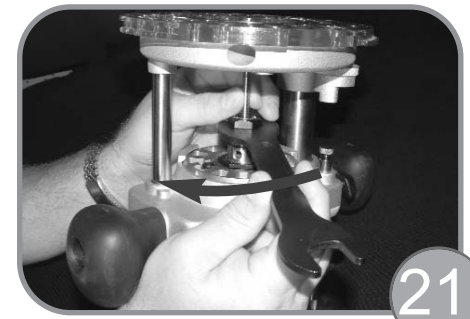

21

INSTRUCTIONS

INSTRUCCIONES

INSTRUCTIONS

ISTRUZIONI

INSTRUÇÕES

ANWEISUNGEN

INSTRUKSJONER

INSTRUCTIES

DIREKTIV

SUUNTASARJA

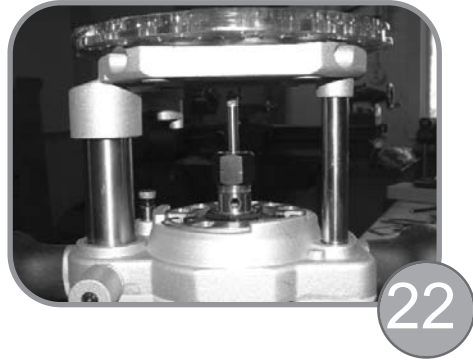

22



23



24

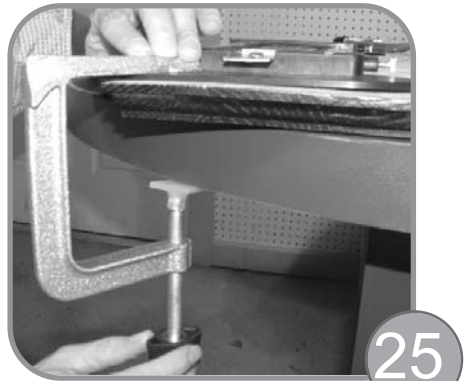

25



26



27



28



N.A. = North America

EU = Europe

Parts list

Teile führen auf

Le parti elencano

Delen sommen op

As partes alistam

Lista de piezas

Les parties énumèrent

Deler lister opp

Stykliste

varaosaluettelo

reservdelslista

N.A. = North America

EU = Europe

N.A.



1x #30114 5/8"

N.A.



1x #30118 7/16"

N.A. & EU



1x #30018

EU



1x #30133

EU



1x 30155 11.11 mm

EU



1x 30143 15.85 mm

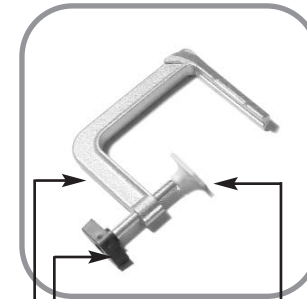

2x #20008
2x #30144
2x #00012

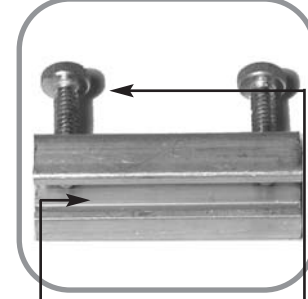

2x #23008
4x #00016

N.A.

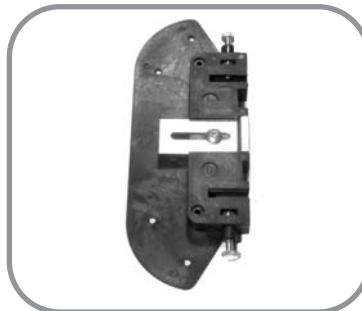

2x 70048



4x 23000
6/9

EU

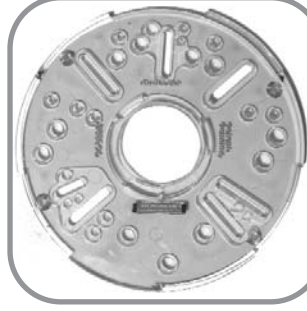

1x #30081



1x #30083

Parts list

Teile führen auf

Le parti elencano

Delen sommen op

As partes alistam

Lista de piezas

Les parties énumèrent

Deler lister opp

Stykliste

varaosaluettelo

reservdelistsita



2x #30013

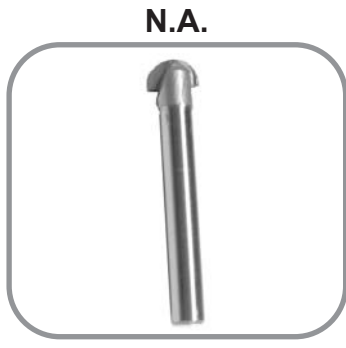

N.A.

1x #70019 3/8"



N.A.

1x 70034 1/4"

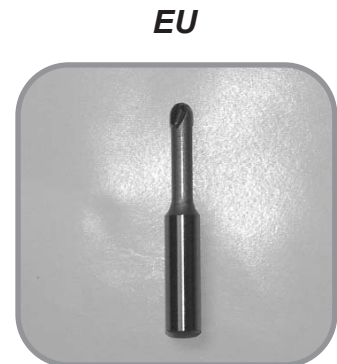

EU

1x #70040 6.4mm



EU

1x #70025 9.5mm

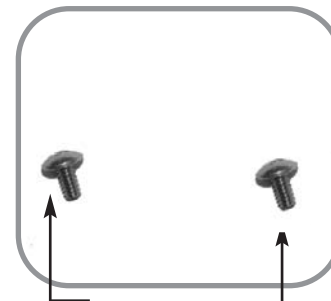

3x 00007
3x 00002



N.A. & EU

2x #22010003 2.5"
2x #22010003 70mm
= 82

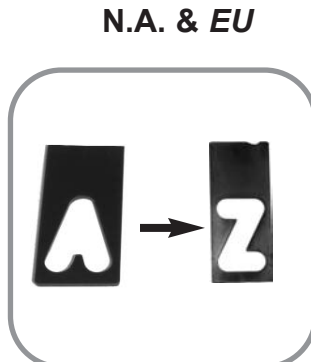

N.A. & EU

2x #22020003 1.5"
2x #22020003 43mm
=82

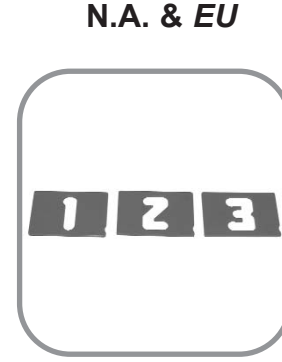

N.A. & EU

2x #22060003 1.5"
2x #22060003 43mm
=20



N.A. & EU

2x #22050003 2.5"
2x #22050003 70mm
=20

N.A. = North America

EU = Europe

EU

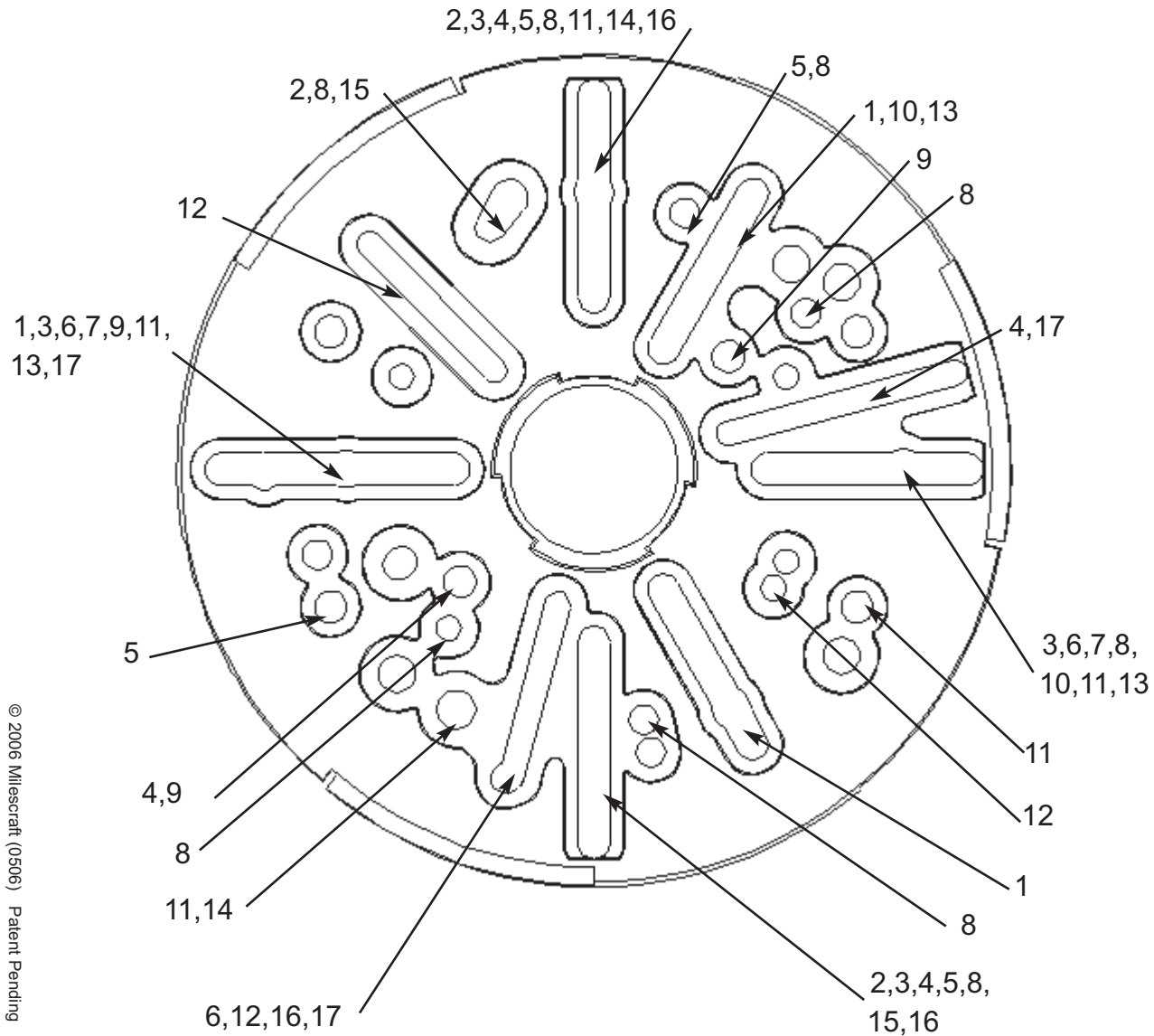

1	Skil Freud Bosch	1835U, 1875U, 1825 FT2000E 1617, 1613EVS
2	DeWalt Trend	DW621, DW613 T5, T9
3	Hitachi Makita	TR12 3612C, 3606
4	Ryobi	R600, RE600
5	Trend	T3
6	KingCraft	KBF1050E
7	Einhell MeisterCraft Hanseatic	BOF850E, 1050E MOF850 MIR-KA2-8
8	Festool	900, 1000, 1010, 1400, 1010EBQ, 1400EBQ
9	Bosch	600W, POF600ACE
10	Metabo	OFE738
11	MacAllister	MAC1250R
12	B&D	KW850E
13	B&D	KW780E
14	CMT DeWalt Fein ELU	1850W DW625 FT-1800 177
15	Festool	OF2000EF
16	Axminster	AW127R
17	B&D	RP400

N.A.

7 IN. TURNLOCK™ ROUTER BASE PLATE MOUNTING KEY

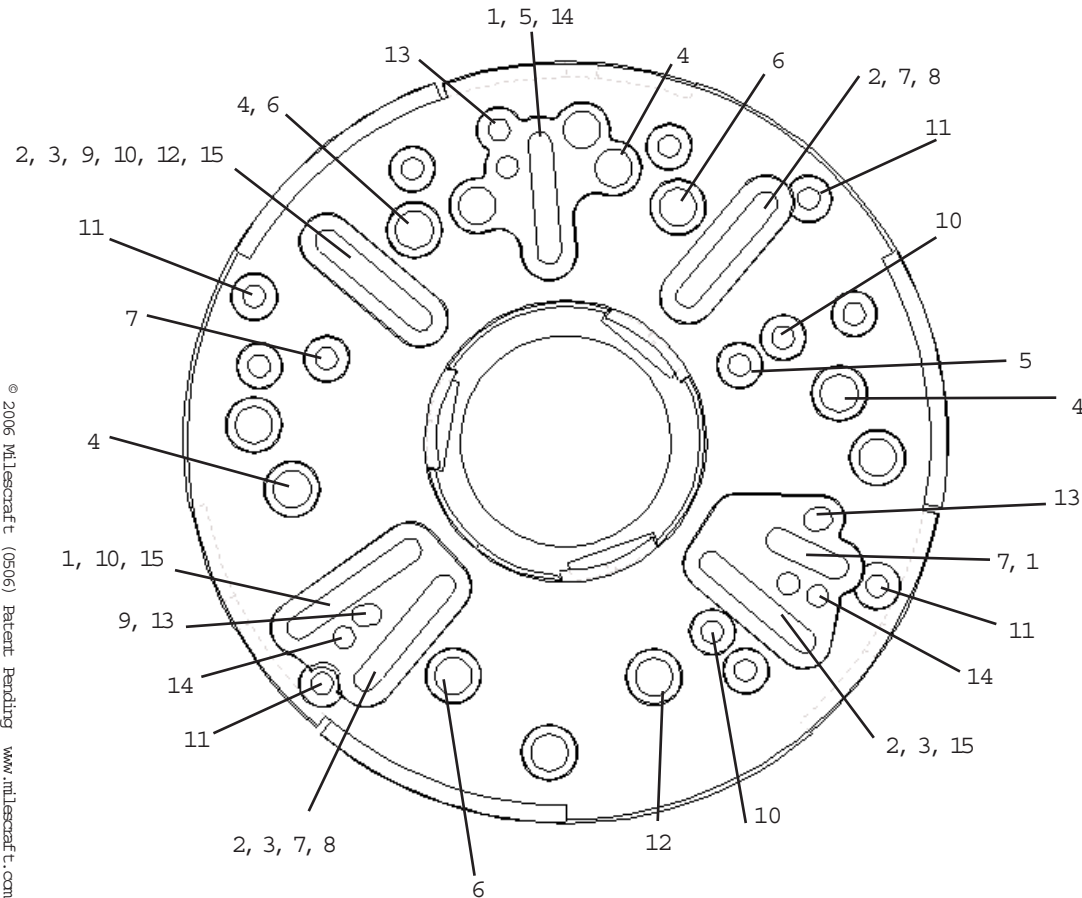

Location	Router Brand	Router Model #'s
1	Skil	1810-01, 1815-04, 1820-04, 1823, 1825-04, 1840, 1845-02
1	Craftsman	(315.) 175020, 175040, 175050, 175070, 17574 (09) 17511, 17515, 17528, 17533, 26834
1	Porter Cable	PC690, PC7529, PC8529, PC890' PC893PK
1	DeWalt	DW618, DW610
1	Black&Decker	RP400
1	Milwaukee	5615-29, 5615-21, 5616, 5619
1	Bosch	1604, 1618
1	Hitachi	M12V
1	Freud	FT1700
2	DeWalt	DW616
2	Craftsman Pro	26835
2	Makita	3606
2	Freud	FT2000E
2	Triton	TRC001
3	Craftsman	27500
4	Craftsman	(315.)275.000
5	Porter Cable	PC7301 (Laminate Trimmer)
6	Ryobi	R161
7	DeWalt	DW621
8	Ryobi	RE180PL
9	Bosch	PO600
9	Dremel	963-01 ("Advantage" Plunge Base)
10	Festool	900, 1000, 1010
11	Hitachi	M12V
12	DeWalt	DW625
12	Fein	FT-1800
12	ELU	177
13	Bosch	1613EVS
14	Bosch	1617
15	Ryobi	RE600

This is not intended to demonstrate all possible routers that can be used with the Milescraft base plate. Other routers can be used with a combination of the slots and holes shown above. 7 in. Base Plate is included in most Milescraft® TurnLock™ router products (e.g.: 1203 Circle/Edge Guide, 1205 Offset Base, 1206 SignCrafter, 1212 SignPro, 1207 Design/Inlay Kit)